

PALLADIUM BOOKS® PRESENTS:

TRIFAX™

AND THE NGR

RIFTS® WORLD BOOK FIVE

BY KEVIN SIEMBIEDA



Warning!

Violence and the Supernatural

This book may be inappropriate for young readers.

The fictional world of Triax & the NGR is violent, deadly, and filled with supernatural monsters. Other-dimensional beings, often referred to as “demons,” torment, stalk, and prey on humans. Other alien life forms, monsters, gods, and demi-gods, as well as magic, insanity and the supernatural are all elements in this book.

Some parents may find the violence and supernatural elements of the game inappropriate for young readers/players. We suggest parental discretion.

Note that Rifts, Triax and all our role-playing game books are works of fiction! NONE of the monsters, characters, magic, powers or depictions are real. None of us at Palladium Books condone nor encourage the occult, the practice of magic, the use of drugs, or violence.

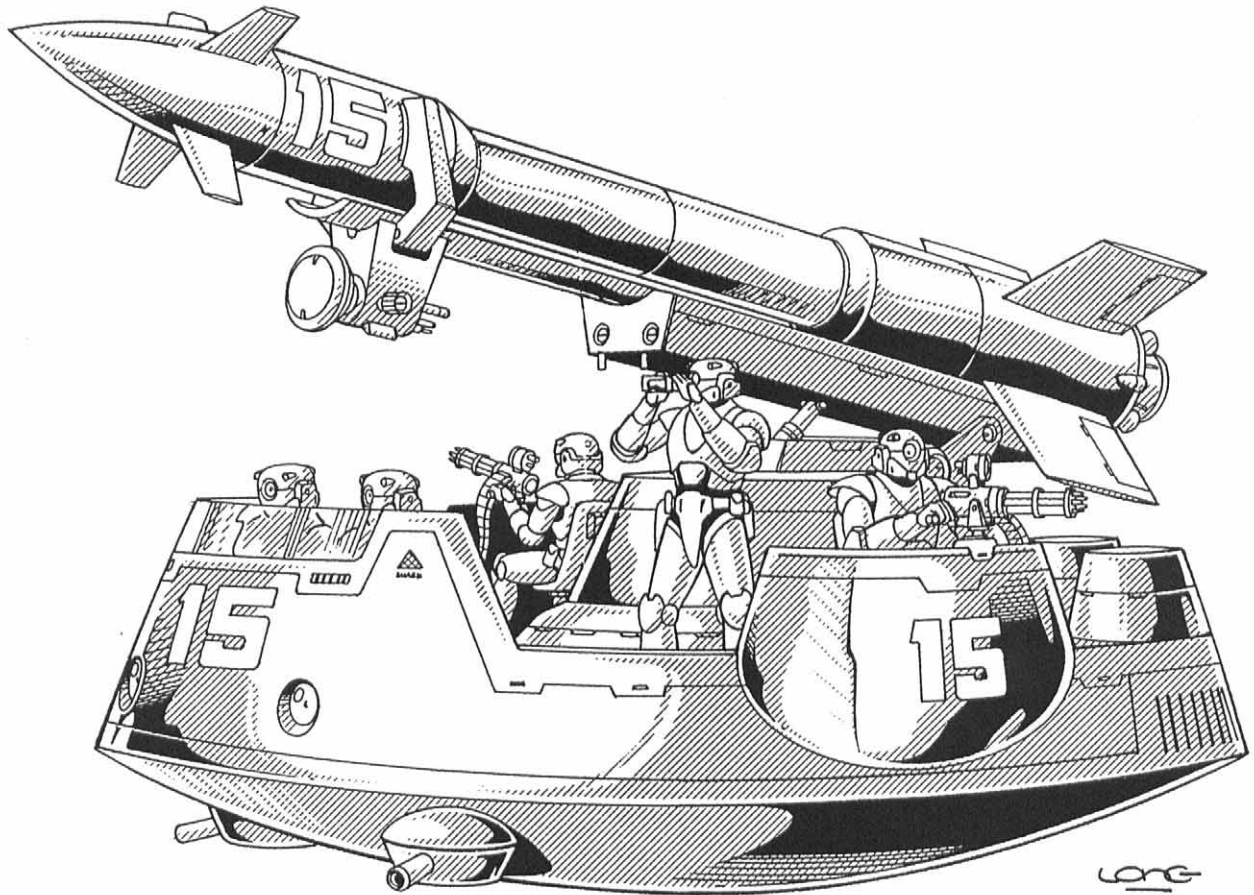

A supplement for the Rifts RPG.

Compatible with the entire Palladium Books® Megaverse®!

Palladium Books® Presents:

Rifts® World Book Five:

Triax™ & The NGR™

Written By: **Kevin Siembieda**

Additional Designs & Concepts: **Kevin Long**

Senior Editor: **Alex Marciniszyn**

Editors: **Thomas Bartold**

James A. Osten

Cover Painting: **Kevin Long**

Interior Art: **Kevin Long**

Newton Ewell

Kevin Siembieda

Art Direction & Keylining: **Kevin Siembieda**

Typography: **Maryann Siembieda**

Special Thanks to Kevin Long for six grueling months of conceptual designing, penciling, repencilling, inking, and toning with stupendous results! Newton for his superb contributions and ideas. Randi and Roger Cartier for always being there to lend a helping hand or to offer a kind word. Thom, Jim, and Kay for their support. And to Alex, Julius, Dad and the usual gang for all their encouragement and dedication.

Contents

Letters from Erin Tarn	7	Cyborgs	99
The New German Republic	13	VX-300 Striker	99
The Bloody Campaign	15	VX-320 Cyclops	101
The NGR — 103 P.A.	16	VX-340 Slasher (Gold)	103
The CS & NGR	17	VX-370 Stopper (Blue)	105
Triax Industries	21	VX-500 Manhunter (Red)	106
Society	22	VX-635 Prowler	108
D-Bees	23	VX-2010 Marauder	113
FIRST-TIMER — by Kevin Long	25	VX-2020 Monster	114
Triax Armor, Bots & Borgs	33	Triax Weapons & Equipment	117
Body Armor	34	Combat Vehicles	117
T-100 Jet Pack	34	XM-50 Medic Ambulance Pod	117
T-10 Infantry	35	XM-60 Field Mechanic Pod	119
T-11 Enhanced	35	XM-70 Covert Operations Pod	120
T-12 Field Medic	35	XM-140 Infantry Support Weapon Platform	120
T-13 Field Mechanic	36	XM-170 Infantry Repair Barge	122
T-40 Plain Clothes	37	XM-180 "Dragonfly" Drop Ship	124
T-41 Riot Suit	37	XM-250 Medical Hover Station	125
T-42 Commando Suit	38	XM-270 "Mosquito" VTOL Airship	127
T-43 Explorer	38	XM-275 "Lightning" VTOL Combat Jet	128
G-10 Soldier	39	XM-280 Fighter Jet	130
Power Armor	39	XM-288 Supersonic Transport	131
T-21 Terrain Hopper	39	XM-300 "Terror" Mini-Tank	133
T-C20 Terrain Hopper	41	XM-330 "Phantom" Hover Tank	134
T-31 Super Trooper	42	XM-350 Leopard III APC	136
T-550 Glitter Boy	45	MZ-10 Wilderness Crusader	138
Robot Vehicles	48	WR-1010 Land Rover	138
X-10A Predator	49	WR-2020 "Shark" Bullet Bike	139
X-60 Flanker	51	WR-5050 Super Cargo Hauler APC	139
X-500 Forager	54	WR-5054 Mini-Cargo Hauler APC	140
X-535 Hunter	55	Weapons	141
X-545 Super Hunter	60	Energy Clips	141
X-622 Bug	63	DU-Rounds	141
X-821 Landcrab	66	U-Rounds	141
X-1000 Ulti-Max	68	TX-5 Pump Pistol	143
X-2000 Dyna-Max	70	TX-20 "Short" Laser Pistol	143
X-2500 Black Knight	73	TX-22 Precision Laser Pistol	143
X-2700 Dragonwing	75	TX-24 Ion Pulse Pistol	144
X-5000 Devastator	79	TX-26 Particle Beam Pistol	144
Robot Drones	82	WR-10 Wilderness Ion Pistol	144
DV-12 Dyna-Bot	82	TX-11 Sniper Laser Rifle	144
DV-15 Sentry-Bot	84	TX-16 Pump Rifle	144
DV-40 Hunter/Killer	87	TX-30 Ion Pulse Rifle	145
Enemy Infiltration Bots & Borgs	90	TX-41 Laser Pulse Rifle	145
EIR-10 Gargoyle Drone	91	TX-42 Laser Pulse Rifle	145
EIR-15 Manned Gargoyle Bot	93	TX-43 Light Assault Laser Rifle	146
EIR-20 Gurgoye Drone	94	TX-45 Particle Beam Rifle	146
EIR-30 Gurgoylite Drone	95	TX-50 Rail Gun	146
EIR-50 Gurgoye Android	96	TX-250 Rail Gun	147
EIC-100 Gurgoye Cyborg	98	TX-500 Borg Rail Gun	147
		WR-15 Wilderness Laser Rifle	148
		WR-17 Wilderness "Double" Rifle	148
		WR-19 & WR-20 Plasma Ejector	148
		TX-10 Mini-Missile Launcher	149

Contents

TX-M4 Mini-Missile Launcher Pack	149	Optional Player Characters	197
Fusion Blocks	149	Gargoyle & Gurgoyles R.C.C.	198
Hand Grenades	149	Gargoyle Lord R.C.C.	199
Vibro Blades	150	Gargoyle Mage R.C.C.	200
Neural Mace	150	Gargoylite R.C.C.	201
Electro-Mace	150	Gargoyles & Technology	202
High-Tech Arrowheads	150	Recognizing EIRs	203
New High-Tech Equipment	151	Robots & Weapons of the Empire	205
Gun Scopes & Optics	151	Gurgoyles Body Armor	205
Medical Items	151	Gurgoyles G-10/Gargoyles G-11 Power Armor	205
Computers, Translators, Etc.	152	Gurgoyles G-20 Avenger Combat Robot	206
New Cybernetic Implants & Augmentation	153	Gurgoyles G-30 Wrecker Combat Robot	208
Eye Augmentation	153	Gurgoyles Weapons	210
Sensors	153	Spikes & Blades	210
Bionic Weapons & Combat Features	154	Blaster Knuckle Spikes	210
New Skills	155	Wing & Tail Blades	211
New O.C.C.s	156	Blaster Neural Whip	211
NGR Army	156	Gurgoyles Firebrand Spear	212
Infantry Soldier	157	Triax Maces	212
Communications Officer	158	WR-12 Giant Ion Pistol	212
Medic/Medical Officer	159	Gurgoyles Grenade Mace	212
NGR Armored Division	161	Gurgoyles Laser Mace	212
Cyborg Soldier	161	Super-Eight Pistol Mace	213
Field Mechanic	162	WR-100 Giant Laser Rifle	213
Power Armor Commando	164	WR-200 Giant Rail Gun	213
Robot Combat Pilot	165	Kittani Laser Wrist Blasters	213
Robot Soldier	166	Kittani Double Blade Plasma Axe	214
M.O.M. Conversion	168	Kittani Plasma Sword	214
Available Robot Types	169	Kittani Energy Lance	214
NGR Intelligence Division	171	People & Places	215
Intelligence Officer	171	A Quick Overview of Europe	215
Intelligence Commando	172	Wilderness	215
Police	173	France & Spain	215
Non-Military O.C.C.s	175	Italy	216
Euro-Juicer	175	Romania & Hungary	217
The JAEP System	175	Vampires	217
Designer Drugs	176	Poland	217
Gypsy O.C.C.s	179	City of Poznan	218
Gypsy Thief	180	Wroclaw — Poland	219
Gypsy Wizard Thief	181	The Brodkil Empire	219
Gypsy Seer	182	The Brodkil R.C.C.	220
Gypsy — The Gifted	184	Gene-Splicers	221
Infiltration — by Kevin Siembieda	186	Notes on Non-Human Good Guys & D-Bees	221
Gargoyle Empire	191	German Word Translations	222
Observations of Erin Tarn	191	Maps	223
About Gargoyles	193	Experience Point Tables	224
The Empire	196		

Quick Find Table

A Quick Overview of Europe	215
About Gargoyles	193
Available Robot O.C.C. Body Types	169
Available O.C.C.s (List)	156
Available Triax Bots & Equipment (List)	33
Available Triax Vehicles (List)	117

Combat Vehicles

Cybernetics & Bionics

Cyborgs: VX Series	99
Cybernetics (New implants)	153
Cyborg Soldier O.C.C.	161
Computers, Translators, Etc.	152
EIC-100 Gurgoyles Cyborg	97
Eye Augmentation	153

Erin Tarn

Erin Tarn's views on the Gargoyles	191
Erin Tarn's views on the NGR	7

Gargoyle Empire

Gargoyle Empire (Locations described)	219
Gargoyle Empire (Map)	223
Gargoyle Firebrand Spear	212
Gargoyle Grenade Mace	212
Gargoyle Laser Mace	212
Gargoyle Lord R.C.C.	199
Gargoyle Mage R.C.C.	200
Gargoyles & Technology	202
Gargoylite R.C.C.	201
Gargoyle Robots & Equipment	210
Gargoyle Weapons	210
Gurgoyles Body Armor	205
Gurgoyles G-10/Gurgoyles G-11 Power Armor	205
Gurgoyles G-20 Avenger Combat Robot	206
Gurgoyles G-30 Wrecker Combat Robot	208
Habitats	194
Hierarchy	194
Methods of Recognizing EIRs	203
Triax Enemy Infiltration Bots & Borgs	90

Occupational Character Classes

Non-Military O.C.C.s	175
O.C.C. List	156
Optional Player Characters	197
Notes on Non-Human Good Guys & D-Bees	221
NGR Armored Division	161
NGR Army	156
NGR Intelligence Division	171
Power Armor Commando	164

New Cybernetic Implants & Augmentation

New High-Tech Equipment

New O.C.C.s	156
New Skills	155

New German Republic	13
Bloody Campaign	15
CS & The NGR	17
D-Bees	17
Elements of Society	21
M.O.M. Conversions	168
The NGR — 103 P.A.	16
Village of Kobernburg	9
Wilderness Villages	8

People & Places

Bloody Campaign	15
Brodkil Empire	219
Brodkil R.C.C.	220
City of Poznan	218
Comic Strip: First Timer	25
Comic Strip: Infiltration	186
Gene-Splicers	221
German Word Translations	222
Hungary	217
Monster Zones	33
Poland	217
Police	173
Society (NGR)	22
The Empire (Gargoyle)	196
The JAEP System	175
Unmutauls (Gang)	217
Vampires	217
Village of Kobernburg	9
Wilderness	215
Wroclaw — Poland	219
Maps	223
Robot M.O.M. Conversion	168

Robots & Weapons of the Gargoyle Empire

Triax

Triax Armor, Bots & Borgs	33
Triax Industries: History	14
Triax Industries: Manufacturing	21
Triax Maces	212
Triax Weapons	117

Weapons

Bionic Weapons & Combat Features	154
Blaster Knuckle Spikes	210
Blaster Neural Whip	211
Body Armor	34
Energy Clips	141
Gargoyle Weapons	210
Gun Scopes & Optics	151
Hand Grenades	149
High-Tech Arrowheads	150
Kittani Double Blade Plasma Axe	214
Kittani Energy Lance	214
Kittani Laser Wrist Blasters	213
Kittani Plasma Sword	214
Pistols	143
Explosives	144
Vibro-Blades	150

High-Tech Notes

Well, after rescheduling and delays, **Rifts World Book Five: Triax & The NGR** is finally done. It seemed that ideas for this book just kept coming and coming. One would spawn six more and from those six, another dozen. Kevin Long spent nearly a year working on conceptualizations and six months doing the actual artwork. We just couldn't force ourselves to take any shortcuts on this one — and we think you'll find it was worth the wait.

Triax is a technological powerhouse. An unbridled industrial giant, incessantly creating new machines to defend humankind from invading monsters from the rifts. Thus, the emphasis is on high-tech robots, cyborgs, power armor, weapons, vehicles, and equipment. **The New German Republic** (NGR) is the haven for humanity in Europe. A technological paradise full of glittering wonders and deceptive peace. Yet, there is a darkness about the two, for although they represent salvation for the humans in the New German Republic, that salvation has a terrible price — seclusion and the abandonment of all other life forms. The world of the NGR and Triax Industries is as expansive and complex as the Coalitions States, with plenty of conflict, adventure, intrigue and mystery.

It happened again. As imaginations took flight, the book began to take on epic proportions and we went with the flow. We had so many great ideas and artwork that we added pages and still didn't have enough space to fit everything! Actually, this is mostly good news, because it means that this book will be quickly followed by a second book that is tentatively entitled, **The NGR Sourcebook One: Mindwerks**. It will provide more information about the gene-splicers, brodkil, monsters, bots, the Gargoyle Empire, Mind Over Matter (M.O.M.) conversions, the NGR, Victor Lazlo, and most importantly, *Mindwerks*. At this point, we don't even know how many pages it will be or how much it will cost. We're shooting for a 112 page sourcebook, but as ideas continue to run rampant, who knows where the final page count will fall. The bad news is you'll have to wait about three months, till the end of May, 1994 — but it will be worth the wait.

There's more good news!

Palladium Books was somewhat quiet last year (1993), until the last few months. The reason was we were busy planning, expanding, and setting a great many things into motion. This means 1994 is going to be big! In addition to new licenses and more books for the **Palladium (fantasy) RPG, Heroes Unlimited, Beyond the Supernatural** and our entire product line, **Rifts** fans will get just what they've been asking for, more **Rifts** titles and more of EVERYTHING!! You can expect to see the following **Rifts** products in 1994:

Rifts Conversion Book Two: Pantheons of the Megaverse (April) will present scores of mythological gods in the context of the **Rifts** environment, providing the somewhat more traditional deity with impostors and uniquely **Rifts** characters.

Mindwerks (May) will deal with the horrific side of high technology and the darker side of Europe's monstrous inhabitants.

Rifts Mercenaries (early Summer) will focus back to technology and the North American continent (although it will include ideas for adventures around the world).

Rifts South America (Summer) will explore the Land of a Thousand Islands, voodoo, magic, demons and more.

Rifts Dimension Book II: Phase World (Fall/Winter) another alien dimension, with its strange denizens and adventure settings.

A **Rifts Anthology novel** is being compiled and we've been discussing the publication of a series of novels.

Plus Kevin Long and I hope to squeeze in **The Juicer Uprisings** and **Coalition/Chi-Town Sourcebook**, and maybe even **The New West**, and **Rifts Undersea** as well. Plus we're exploring plans for miniatures and Palladium's entire product line.

The **Rifts Role-Playing Game** may be the most popular role-playing game Palladium Books has ever published (and we've had our share of mega-hits)! There seems to be more **Rifts-Fans** every day and we're only getting started!! The Megaverse is a big place. There are countless ideas and possibilities to explore. The **Rifts RPG** series is a story about that exploration as well as a cosmic story of discovery, survival, courage and heroics. Enjoy the adventure.

Kevin Siembieda

The New German Republic through the eyes of Erin Tarn

Compiled from letters by Erin Tarn Fall, 103 PA

We arrived in the New German Republic from the Mediterranean, through the countries once known as Italy and Austria, and currently known as the Gargoyle Empire. I don't know what I expected to see in this "Empire" of monsters. I guess after hearing the stories about Atlantis and having visited Wormwood, I expected to see demon cities everywhere. I am told there are villages and cities populated entirely by gargoyles and supernatural beings, but we didn't stumble across any.

I was surprised to learn that many of these monsters, gargoyles and their kin in particular, live in a tribal society, gathering in

small clans and tribes rather than one big amalgamation of people. Consequently, small nomadic clans (2D4 × 10 people) and tribes (1D6 × 100 people) are more the norm. Clans, tribes, bandit gangs, combat squads, and lone hunters are scattered throughout the vast wilderness of Europe. Consequently, a traveler is much more likely to encounter a small handful of demonic menaces rather than an entire army. We had many such encounters. In some instances we'd face a lone monster, but monstrous animals and supernatural beings with low intelligence and strong predatory instincts, tend to avoid groups of 12 or

more people. They also try to avoid travelers clad in giant robots or piloting armored vehicles. We found attacks by small groups of brigands to be more common.

The only encounter with bonafide gargoyle soldiers was with a well-armed group of six gurgoyles, a gargoylite, and their gargoyle commander. All carried swords or battle-axes and various gargoyle weapons, blades and spikes. Two had rail guns, another a magic axe, and the commander had a giant-sized laser rifle and a Kittani plasma sword.

Most attacks came when our group was divided or otherwise vulnerable, like when most of us slept at night. Only a fool wandered off by himself. We never splintered into groups smaller than four individuals and never too far from our companions. Our most notable encounters included an attack by a lone gallu bull demon, a line walker accompanied by a malignant and three orcs, a pair of gargoyles, five brodkil (three had bionic augmentation and energy weapons), and a group of gargoyle bandits who disappeared into the forest when we proved to be too tough for them.

We saw dragonductyles and gryphons flying in the sky, as well as small flocks of gargoyles and a solitary dragon. From time to time, we'd find the tracks or catch a glimpse of other beasts and enemies of man. Near the Black Forest we encountered poltergeists, and outran a tectonic entity made of leaves, sticks and stones. Although many of the natives complain of faerie folk, we did not encounter a single one.

Signs of battle could appear anywhere. I was awakened from my sleep on two occasions from the sounds of distant explosions and gunfire. In the middle of a forest, a traveler can happen upon an area devoid of life. In some cases, the area may be dead from radiation and is not a safe place to linger. In other instances, trees are toppled, stomped, smashed, blown to bits or pulverized by combat between powerful forces.

These areas of destruction can be small, covering the circumference of a house, or the size of a football stadium (not just the field), or cover miles. One stretch of woodlands we found was completely decimated. Its trees were broken and smashed to look like a giant pile of kindling wood that spanned miles! Most of the trees were dead and laid one on top of another in piles ten to twenty feet tall. Many were charred and there was evidence of a forest fire, although most of the trees seemed to have fallen victim to other means of destruction. Trunks were splintered and snapped in two from the punch of a giant robot or the claws of a monster. Some of the cut ends of tree trunks and limbs were completely smooth and slightly burnt, indicating laser fire. Patches free of debris were blast craters made by missiles, particle beam weapons, and magic lightning. Other clearings were made from the tussle between giant beings locked in combat and a few zig-zagging paths marked the passage of some bot, vehicle or giant that plowed its way through.

I am told if one carefully walks among the shattered remains of this forest, he can find spent rail gun shells, bits of armor and the bones of gargoyles. The level of destruction was incredible. The shattered forest was so large and impassable, at least with our vehicles, that we had to make a 20 mile (32 km) detour. However, I was glad to see green grass, vines, flowers, and the occasional sapling pushing itself out of the rubble.

We also saw decimated villages. I'm not talking about dilapidated buildings, I mean entire communities burnt to the ground



or smashed into rubble. The gargoyles and their minions are brutal and thorough. Any humanoid habitat they do not intend to inhabit, they completely destroy. I am told that depending on the needs and whims of the savage creatures, the inhabitants are enslaved, eaten or tortured and killed for the sheer pleasure. Walking through the rubble and knowing that probably three quarters of the people were killed cast a silence over our entire group. You can't help but feel that you are walking on the bones of hundreds, perhaps thousands of people.

Wilderness Villages

The D-bees have it the worst. The government of the New German Republic has completely turned its back on non-humans. Neither the government nor the military will give D-bees the smallest amount of protection or supplies. The NGR's policies regarding non-humans and their treatment of D-bee refugees is common knowledge to all. The overwhelming majority have given up begging the humans for anything and struggle to survive on their own as best they can.

Since most wilderness people are impoverished, they must rely on magic, scrounged and stolen weapons, and the kindness of strangers. This desperate situation creates some strange communions. I have heard about villages that will tolerate, even invite, bandits and mercenaries into their community in hopes that they will help to protect them. In other instances, the people will welcome the rule of tyrants, whether the despot ruler/protector(s) is a powerful practitioner of magic, dragon, demon or invader, the people don't care. Under this kind of protection

and rule, the people often suffer at the hands of their alleged benefactor(s), but it is better than extermination at the claws of the gargoyles or other inhuman fiends.

Consequently, there are thousands of tiny kingdoms and territories throughout Europe and around the NGR. Often the so-called kingdom is barely the size of a village and may have less than 500 subjects. Frequently, several communities (I cannot honestly call them kingdoms) lay claim to parts of the same territory, squabble and have little skirmishes among themselves. The vast ethnic diversity of the scores of humanoid D-bees who inhabit the land only adds to the tension and fighting.

I lambast the Coalition States and the New German Republic for their unconscionable acts of prejudice, discrimination and murder of non-humans, but many of the wilderness D-bees are just as bad. One race will hate another because they are different. There are even divisions among the members of the same race based on social classes, heritage and history. I find it ironic, that often these same fiercely prejudiced D-bees will lament, wonder at and curse the New German Republic for their inhumanity to them while they deal it out to others. The most feared and hated among the D-bee wilderness people are the gargoyles, brodkil, gene splicers, vampires, werewolves, and all demons, pretty much in that order. The NGR and humans usually fall at the bottom of the list, although there are those factions who hate humans above all others. The atmosphere of terror is thick in these communities.

Gypsies and bandits who prey upon demons and/or humans are frequently revered as heroes. I found it interesting at how many wilderness D-bees saw both the monsters and the humans as enemies. Both were powerful forces. Both commanded conquering armies. Both chastised, used and abused D-bees. Both were cruel destroyers and murderers who took what they wanted without regard for D-bees. The only difference between the two was that one was more savage and cruel than the other. Which was worst, demon or human, depended on who you were talking to.

I have never felt so odious in my life. In the Americas, it is I who am the minority. Many of my fellow humans regard me with fear, disdain and hatred because I question their world and associate with creatures they deem undesirable, whether they be men of learning, men of magic or dragons. Despite the efforts of the Coalition States, humans and non-humans are, generally speaking, on equal terms. One has not taken the advantage over the other.

On the Living Planet, Wormwood, I was the hunted. As a human, I was an enemy of the Unholy and his Forces of Darkness. At best I was a commodity, like cattle to be captured, enslaved and domesticated. More likely I was a plaything to be tormented and finally eaten or slain. But there were humans and their sometimes inhuman, certainly magic wielding, allies. Two clear sides fighting each other for dominance of their world.

In the foothills of the New German Republic things are different. Here I am one of the elite simply because I am human. Being human means I am a creature of power, protected and avenged by the greatest technological and military power on Earth. Non-humans abandoned by the people of the NGR see me as one of the faceless people who control the land, command powerful machines, and fight only to preserve my own civilization. Thought to be a citizen of the NGR, I am one of the

privileged to be honored and envied by non-humans. I represent the enemy to be feared and hated not because I might strike them down, but because I turn away without so much as a kind word to those who suffer around me.

It was a very difficult experience for me. To be hated not even for the things I believe or the words I write, but simply because of my race. It fills me with a sadness that sends shivers up and down my spine even as I write these words. How many people before me have seen this tragedy and asked, "why?" only to be greeted by silence and a feeling of emptiness that I cannot find the words to describe. It makes me worry for my own homeland and for all the people of Earth.

Arrival to the New German Republic

The Village of Kobernburg

There is no wall, or signpost, or tangible borderline painted on the ground to tell you that you have entered the New German Republic, but you know. The shanty towns, the poor peasant villages and dirt smeared, non-human faces fade into the shadows you have left behind. Once within its borders, one gets a feeling of peacefulness and safety. The farmlands are lush and well manicured and the sprawling, modern farming complex replaces the traditional farmhouse and stables. The faces one sees are only human. They are clean faces but not all are smiling.

I found the New German Republic to be a land of contrasts and contradictions. Despite the politics, prejudice and danger, I found Germany to be a surprisingly enchanting place.

The first of the outlying villages we visited was a quaint little place called **Kobernburg**. It is precariously located a hundred miles away from the demon ridden "der Schwarzwald," the Black Forest. There are no factories, office buildings or obviously high-tech buildings anywhere that I could find. Along the winding streets of cobblestone were picturesque row houses (apartments) and Bavarian style chalets. Most of these structures stood two and three stories tall. I later discovered the cobblestones are a man-made ceramic as strong as steel and said to last ten times longer than the genuine article (I couldn't see any difference).

Ancient looking street posts like the kinds that were once lit by hand, dotted the street corners. Of course, in actuality they are halogen lights powered by a hydroelectric plant somewhere nearby. I could smell fresh baked bread and pies from a bakery and the occasional whiff of sausage carried by a gentle breeze from a sausage factory at the east end of town. The muffled beat of rock music could be heard from one of the row houses across the way. In the distance, the brief, high-pitched whine of an electromagnetic monorail train broke the morning calm. The music and the train noise were all that reminded me I had not been transported to a quieter time in Earth's history.

A moment later, the tranquility was broken by a rapid thudding noise that seemed to be coming closer. Just above the rooftops of the row houses appeared a pair of giant, black, mechanical heads and spike covered shoulders. I could now hear the groan of an engine and the whistle of hydraulics as the two giant bots turned their bodies to look around, before tromping off out of

sight. I learned they were NGR robots known as “der Schwartzritter,” meaning the Black Knight. A military base on the edge of the Black Forest had permanently stationed two power armor squads (16 soldiers) and these two robot defenders to protect the village.

I also started to recognize more and more signs of our modern times. Tiny communication dishes and antennas mounted on rooftops, thermopane windows, aluminum, metal and concrete construction could be found everywhere. However, the most telling evidence were the people. They wore modern overalls, business suits, and clothing, carried briefcases and wore headphones or earjacks while they listened to pocket CD players or radios. Some bore the external signs of cybernetic or bionic augmentation. Small one and two person hovercycles swooshed past bicyclers and down the crisscrossing streets of mock cobblestone.

Many of the traditional looking buildings had business signs hanging from their shingles. Peeking inside, I found modern offices with telephones, computers, flat wall monitors, and every modern amenity one would expect to find in Chi-Town.

As we explored our surroundings, I discovered the village to be much larger than I had originally surmised. I would have guessed that it covered an area no larger than two miles (3.2 km) and had a population of less than 3000. In reality, the village covered a six mile (9.6 km) area and had a population of 10,000!

The people seemed wary of strangers and went about their business, keeping their distance from us. We stopped at a restaurant where they served hearty German cuisine that I enjoyed immensely. After months of eating bugs on Wormwood and then eating dehydrated processed food, game animals, fruits and vegetables during our harrowing adventures in Africa, I enjoyed every morsel I ate while visiting the NGR. The ale and beer were also to my liking, even though I rarely drink them at home.

The Military Base

As we made our way toward Munich, we passed within eye-shot (well, binocular distance) of a military base. I was concerned that we might be stopped, questioned and captured. After all, Victor Lazlo and some of my other companions were wanted criminals in the mind of the government. However, Victor assured me that we would not be molested and if we were stopped, that our forged identity papers would get us by. Not more than five minutes later, we were stopped by a military patrol. A “Drachenfluegel,” Dragonwing, zoomed out of the sky, slowed down to match the speed of our two battered vehicles and radioed us with a request to stop. I turned to Victor with eyes glaring the unspoken words, “I told you so!” A few moments later, four “Jagers” came running up a lightly forested hill at a beguiling speed. My companions tell me this versatile power armor can reach a running speed of 140 mph (224 km) and is one of the NGR’s main infantry units. Of course, they are the creation of the famous Triax Industries.

Apparently, there had been recent problems with D-bee bandits and gypsies, so the military was checking the identity of all travelers in the area. Victor had wisely sent our non-human companions on a different route, so only humans were among our party. I must admit, although I was initially frightened, it gave me a unique opportunity to see part of an NGR military installation.

As we approached the base, I was not impressed. Only a dozen long, low, one-story buildings could be seen. The base was encircled by a 15 foot (4.6 m) electrified fence followed by a 50 foot (15.2 m) length of mine field (Victor says they use concussion mines). We were taken to one of the long buildings that housed the administration offices. We were met at the parking area near the door by two uniformed soldiers accompanied by four troopers in environmental body armor. The uniforms and armor were all in grey with black accents and had black or red bars/insignias to indicate rank and squadron. As we were being escorted to the door, I was watching four Dragonwings hovering above an empty field. A pair of Landcrabs and a handful of vehicles were idling nearby. I found this curious because the only building in their vicinity was a tiny structure that looked like a supply shack or guard’s hut. I involuntarily stopped and gasped as one end of the empty field began to rise up out of the ground. One of the uniformed soldiers gently took hold of my arm. In anticipation of my question, he said, “Mam, that’s one of our underground maintenance hangars. Those bots and trucks are waiting to go in for a check-up. Now, if you would please follow me.”

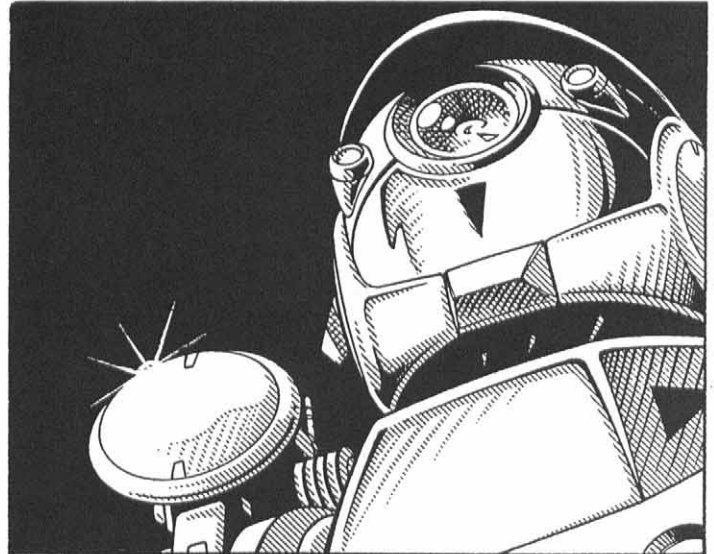

Victor served as our spokesperson, feeding them a story about us being members of a research team studying the effects of some new malady plaguing the residents of a neighboring D-bee border village. He made some disparaging remarks about D-bees and their filthy habits and would have convinced even me. Victor has learned to be a wonderful actor. We were cleared to leave, but, since my false identity was an observer from the Coalition States, the commander insisted on our spending the night. Victor tried to excuse us, but the commander would not hear it. We were allowed to shower, provided with nice, clean clothes and served another wonderful meal. Before being allowed to retire for the night, we were given a brief and limited tour of the base, all for my benefit.

During the entire tour I was asked what I thought of their country, people, science and facilities. Of course I heaped on the praise. We saw one of the communication stations, vehicle repair area, troop barracks, the hospital, some of the administration offices, mess hall and officers’ quarters, where we spent the night. Unlike Victor, I didn’t have to pretend much when it came to being impressed by their level of technology and creature

comforts. Everything I saw was on par with or surpassed the Coalition States.

One funny incident did occur. While visiting the mess hall, a couple of soldiers were looking at a magazine. Before they knew we were present, I overheard them talking about a hot fraulein who had brains and a body. When they snapped to attention to acknowledge the colonel, our guide, they dropped the magazine at my feet. I looked down to see a double page advertisement with a blonde, beautiful woman. She was nude except for a strategically placed flag of the Coalition States and a book. The smiling girl looked strangely familiar and the book she was holding was one of my books! Or more precisely, a new, unauthorized German edition of one of my books. I must have looked shocked, because the colonel barked for the soldier to snatch it up and apologized to me.

Victor, in a maliciously playful mood, asked to see the magazine. He grinned an evil smile and said, "So, that's Erin Tarn, eh?" He looked directly at me with a smirk and said, "I always thought she was a much older woman. Maybe even the motherly type."

I must have turned red because I could feel my cheeks burning and Victor was now grinning like the Cheshire Cat. The colonel seemed more concerned about me than ever. He pulled the magazine from Victor's grasp, gave him a stern look, and shoved it back into the soldier's hands. He turned to me with a nervous expression and said, "I am so sorry, madam. I hope this advertisement did not offend you. I know that Erin Tarn is an esteemed folk hero in your homeland. I am told that her writings are even more popular in the Republic."

He gulped and continued, "We have always depicted this great adventurer and historian as a young woman. In the last year or two, it has become popular to present Miss Tarn in a more ... um ... sex ... er ... sentu ... ah ... dynamic way. Of course, these portrayals are not the real fraulein, but a computer creation using the young Erin Tarn's facial features."

Victor couldn't stop himself from letting out a loud laugh and even my dear Sir Thorpe was chuckling. I muttered something idiotic like, "Well, yes. Of course. No harm done. I mean I've seen nudity ... I mean, I am not offended by ... I just ... it ... was unexpected to see ... I am certainly hungry."

The colonel seized that cue and hustled us away to eat. Of course, Victor, Sir Thorpe and my other companions would not let me live this down. In the city, they made certain to point out every poster, commercial and video display they could find. I, or I should say, my sexy computer generated alter-ego, was plastered all over the big cities. Apparently, this latest book was another best seller and we happened to visit the NGR during the middle of a hot promotional campaign. I only wish I had ever looked that good at any point in my life! It was all very amusing. In fact, when we were alone that night and my "friends" reenacted the scenario, I laughed for an hour. During quiet moments throughout our trip the incident would be mentioned and spark a barrage of laughter and silly jokes. I am delighted to report that I was able to get copies of this book and all of my Euro-language books (and many English language editions) on two, one inch computer/video disks.

I am flabbergasted at my cult-figure status. It seems I am the Marilyn Monroe of the New German Republic, only more scholarly and more voluptuous (if you can believe that! Really!!). If

I didn't have the soul of an adventurer and wasn't an outlaw in so many places, I'd chase down these clever entrepreneurs to get my share of a substantial royalty and live like a queen for the rest of my days. I can see it now, I'd be a guest on every talkshow, have my own computer net column, and they'd make a movie about my life. No, a series of movies about all my adventures! Men, old and young, would be worshiping the ground I walk on. I'd have a big mansion, servants, bots, fame and fortune. Funny, but I could probably get most of that in the NGR, not that I'd enjoy it. I'm just not the fame and fortune type. I want to be part of the people not *apart* from them. It was a little weird but loads of fun.

The Big City

One must realize that the New German Republic is a vast territory of plains, forests and rivers. It does not have a large majority of its people crammed into a handful of cities. They are scattered throughout the nation, living in a thousand villages; some large, some small. The six largest cities in the NGR account for approximately 25 million people, but that is less than 30% of the nation's entire population (and does not include the unofficial D-bee refugee population).

The oldest communities to survive the Coming of the Rifts have a number of Pre-Rifts buildings still standing. Of course, they have been repaired but they are as close to the original article as I'll ever find.

The first big city I visited was **Munich**. Toward the north part of the city is a cluster of a dozen 50 story skyscrapers, but like so many of the communities in the NGR, Munich is a sprawling city, not a towering one. Most of the buildings are 10 to 20 stories tall. The styles of architecture varied dramatically. There was Baroque, Bavarian, Bauhaus, art deco and ultra-modern structures. A high-tech monorail train system that weaves through the city like a giant spider web and has tendrils out to the military base and communities for miles around.

I am told that all the big cities have their own unique personality and an area of traditional emphasis. Munich has always been a community dedicated to the arts, theater, and recreation. Being only 44 miles (70 km) from the Alps, during the Pre-Rifts days it was a vacation paradise, with year-round skiing, hiking, swimming and attractions.

Munich's vacation atmosphere has not changed significantly in my opinion. It is a bright, pretty, lively city and has become a center for communications and the arts. There are over a hundred libraries (books and disks), three hundred art galleries, five hundred theaters (movie, live, and virtual reality), scores of dance halls, nightclubs, beer gardens, spacious inner city parks, skating rinks, museums and shops of every kind. Of course, since the Coming of the Rifts, the city is physically larger, much more modern, and has tripled its population (currently about 3.9 million people), many of whom are refugees from Austria, Poland and Czechoslovakia.

Don't get me wrong, Munich is not all sparkle and good times. It has the third largest Triax industrial complex in the country, located near the banks of the River Isar. I have heard a lot about Triax, but I was staggered to see this facility. Administration, business, and promotion offices cover two entire city blocks. This facility's main function is the development of electronics and communications technology. They design and manufacture

computers, computer chips and components, audio-visual communication systems, miniature robot medical systems, nano-systems, weapon systems and just about anything else you can think of that's connected with electronics and communications. Pocket translators, cameras, televisions, radios, monitors, surveillance equipment, cybernetic relays, and much, much more all wear the brand name of Triax. Thus, each of these design areas have their own division. The central industrial and design complex covers 20 city blocks! This does not include the comparatively small (only consumes three city blocks) medical systems complex or virtual reality division located at the other end of the city, or the shipyards a few miles down the river! Nor does it include the hundreds of smaller workshops, factories, or design agencies who produce similar items or are subcontractors to Triax.

Munich also has an active film studio, several broadcast stations, two fusion power plants, a hydroelectric plant, several breweries (they are famous for their beer), cybernetic and Juicer augmentation clinics, and is the entertainment center of the country, from films and virtual reality to entertainment systems like disk players and computer games.

I was surprised to see that there were very few private vehicles in the city. Surprised until I used Munich's incredible rail system. The city has both a subway system and an aboveground magnetic rail transit system. Both are excellent and will put a commuter within a few blocks of wherever they want to go. Residents also ride bicycles and walk a lot. We stayed in Munich for three months and I revelled in every minute of it.

City Gangs & The Unmutuals

Crime in Munich seemed low, although there is regular trouble with gangs. I found the human supremacists the least to my liking. Other gangs are street punks and criminals who engage in disreputable works. Others are just wild youths on the wrong track to prove their manhood and engage in painting graffiti, vandalism and petty crimes. Compared to Chi-Town and the Chi-Town Burbs, these gangs are social clubs. However, I understand that city rat and gang violence is much worse in some of the other cities. I am told that Dusseldorf and Ruhr have serious crime and gang related problems.

I found it very interesting that the majority of the NGR's so-called "gangs" are not criminals but underground political activists. They include human supremacists, D-bee liberation groups, M.O.M. conversionists, mystics, free-thinkers, anarchists, and the politically incorrect. In most cases, these gangs are tiny, with as few as a half a dozen members. What I would consider a real gang or underground organization rarely had more than two hundred members (typically 50 to 200).

Of course, for every rule there seems to be a few exceptions. The most notable exception is the organization known as, the **Unmutuals for Free Thought**, whose membership is estimated to be in the thousands. This group has a huge following with branches and imitators in most of the major cities and some of the villages. They tend to be popular among the common people and city rats. I had heard a great deal about the Unmutuals and had the pleasure of meeting with several members. From what I saw and heard, they sound very much like the rogue philosophers, scholars, mages and freedom fighters back home at Lazlo and Tolkeen. All they really want is to be allowed to

live and enjoy life without being branded, persecuted or hounded by the more dominant members of society.

I found the Unmutuals to be non-conformists, eccentrics, rogues, and dreamers who are not afraid to express themselves as individuals, even if those in power chastise them for it. Unfortunately, this means their ideas, attitude and conduct are often *different* than the accepted *norm*. Rarely anything violent, destructive or revolutionary, mind you, just different. In fact, the Unmutuals seem to be outstandingly creative, compassionate and inventive free-thinkers. I read several of their underground publications and they were wonderful. Many were uplifting, insightful, moving, or just plain fun. Others were critical of the government and of the attitude/mores of factions in society. However, I found nothing in their content to evoke the ire from the government that they do (Of course, look who's talking. I guess I am not the best judge in these matters. Undoubtedly, I'd be an Unmutual if I lived in the NGR and expressed myself about this society as I do about home).

Worst of all, these misfits don't care that they don't fit in and seem to be enjoying themselves without the approval of their peers. Likewise, the Unmutuals' viewpoints and strong individual spirit cannot be appreciated or understood (and is often misunderstood) by those in power. As is so often the case, what humans don't understand, they tend to fear and resent. What they fear and resent, they attack and destroy. Consequently, the Unmutuals are at the top of the government's and local law enforcement's list of dissidents and criminal activists.

What, you may ask, are some of the Unmutual's dangerous anti-social beliefs? One of their credos is the right of the individual. This includes the freedom of personal expression and the basic right to "think" and believe whatever that individual feels is right for him. The Unmutuals are not anarchists who believe the world is chaos and that the individual has the right to think and "do" whatever he wants, regardless of who it may hurt. The Unmutuals never deliberately try to destroy, hurt or antagonize anybody. In fact, most simply want to be left alone to pursue their dreams and enjoy life. They also vehemently defend the individual's rights of creative expression, which has resulted in some strong, non-violent confrontations with NGR leaders and law enforcement.

Another credo is that an individual can make a difference through his words or actions. These words or actions may be a great accomplishment that touches the lives of thousands or a simple act of kindness. This means that every person, even the lowliest peasant and D-bee, has value. The Unmutuals' high regard for personal expression and all life, including non-humans, is one of the things that gets them into the most serious trouble.

Although the Unmutuals do not actively associate with, or recruit, D-bees, they are outspoken about their worth as persons (equal to the worth of a human). They are also outspoken about the injustices the NGR and human supremacists continue to inflict on these intelligent and feeling people. Since the Unmutuals accept and respect their member's beliefs, they don't stop them from associating with D-bees. Some members are even actively engaged in humanitarian efforts, like Victor Lazlo, in trying to help the D-bees by educating them in the ways of agriculture, science, medicine, building, and self-defense. They may also warn their D-bee friends of troop movements and rising anti-D-bee sentiments, as well as bring them news and basic supplies.

Victor Lazlo's organization is also based in Munich. The chief reason for this is mainly geographical. Switzerland, Austria, Hungary, Czechoslovakia, and even Poland are all relatively close. From Munich they can coordinate relief programs to help the D-bees and wilderness humans who live in these territories. Victor and his diverse group of people are not out to undermine the NGR, but to help the innocent D-bees and wilderness people along its borders and in the Monster Zones. Of course this humanitarian effort makes Victor and his associates dangerous enemies in the eyes of the government and the military. I dare not say more at this time. I don't want to jeopardize Victor's operations or endanger his people.

The New German Republic

The Great Cataclysm caused by the energy eruption of the ley lines decimated most of the planet. Scholars have speculated that less than 10% of the world's population survived. For approximately 200 years, the inhabitants of Earth struggled through a period known as the Dark Ages (or Second Dark Age for those familiar with the history of Pre-Rifts Earth). Cities lay in absolute ruin. Science, technology, data bases, books, machinery, automobiles, and civilization were crushed and buried beneath the rubble of a lost people. Any sense of history, nationalism, and the fundamentals of education quickly faded into oblivion. Unnatural storms, earthquakes, unseasonal weather, and rampant disease made survival all the more tenuous and claimed millions of more lives.

It took nearly a hundred years for the turbulent forces set free from the Great Cataclysm to settle into a comparative calm. The eruption of the ley lines and the release of mystic energy had transformed the Earth into an alien world. Pulsating towers of sparkling blue and white energy tore holes in the fabric of space and time, creating doorways to a thousand different alien worlds. Mystic energy coursed along the ley lines, providing the energy for the fledgling science of magic. That same mystic energy would serve as a beacon to creatures sensitive to magic and bring supernatural horrors and creatures of magic to inhabit the Earth. Earth had suddenly gained cosmic importance. It was a new frontier and a means of traversing the Megaverse, bringing dimensional beings to tap its power and lay claim to its resources. The existence of magic and the arrival of dimensional travelers, supernatural beings, alien organisms, monsters, and inhuman invaders would forever transform the face of the planet and the future of humankind. The question, "Are there other intelligent life forms in the Universe?" had been answered in a most alarming and indisputable manner.

The plight of humankind was complicated by the increasing presence of these otherworldly beings. Not only did humans have to rebuild from the immeasurable destruction caused by the Great Cataclysm, the loss of civilization and the reshaping of the continents, but the survivors also had to compete with strange, frequently superhuman creatures who also laid claim to the Earth. Fortunately, the appearance of supernatural and alien life forms has been a reasonably slow process, giving humankind a chance to adapt and rebuild. Like any new frontier, it took time before Earth was discovered and more time for word to spread and attract others. In the cosmic scheme of things, Earth, with its many dimensional rifts and vast mystic energy, is largely unknown to the vast majority of beings who exist in the Megaverse.

Most high-tech communities like the Coalition States and Northern Gun grew out of the rubble of lost civilization. They have grown to power through the *rediscovery* of Pre-Rifts science, technology, and industrialization. The people have worked hard to relearn and master the knowledge of their forefathers and reclaim their place on Earth. Other places of civilization, like Atlantis, utilize alien technology and/or magic.

Fate seemed to smile on the people of Germany. While the rest of human civilization lay in absolute ruin, Germany, Austria, and southwestern portions of Poland, survived comparatively intact. The eruption of the ley lines were far less severe and although millions died, cities crumbled and civilization collapsed, a large number of people survived. An estimated 45% of the population and 31% of the cities remained, and with them the knowledge of modern science, technology, and education. Few supernatural monsters or alien beings populated these countries for the first two centuries, allowing people the luxury to reestablish themselves and ultimately create the New German Republic (NGR).

Triax Industries

A large percentage of the New German Republic's (NGR) accomplishments were made possible by the survival of the corporate superpower known as **Triax Industries**. With 50% of its factories and manufacturing resources intact and 84% of its technology preserved, Triax was instrumental in the rebuilding of Germany.

In the early days after the Great Cataclysm, the people of Germany were lost to despair and anarchy. Humans preyed upon humans. Marauding gangs and clans fought over land and resources. Scavengers dug through the rubble of toppled cities salvaging whatever they could. Tiny feudal kingdoms emerged here and there only to fall to war, disease or poverty. It was the appearance of Triax as a political and military power that brought the people together.

Triax Industries had been a leading developer and manufacturer in the areas of robots, cybernetics, weapon systems, and space technologies. When the Great Cataclysm struck, Triax Industries was the fifth largest and wealthiest super-corporation in the world. After the global destruction, the people of Triax were as shocked and terrified as anybody else. The families of corporation executives and workers fled to the industrial complexes for refuge and camaraderie. Bound together through their work relationships and corporate structure, they were able to work as a productive force. The factory and design complexes were huge to begin with, covering the length of several city blocks. Most had independent nuclear, solar or other power sources as well as manufacturing facilities still intact. These resources were put into action to make repairs and modifications that turned them into factory fortresses. With time they became little industrial cities with additional housing and an army of robots to serve and protect the community.

For the first few decades, the families of Triax cowered in their technological ivory towers, prayed, and hid from the world. The Triax personnel and their families were so concerned with survival and defense that they didn't realize how self-sufficient and powerful they had become. It was only when the Triax cities easily repelled numerous attacks from feudal lords, bandits and a few supernatural horrors that they began to recognize their own strength.

Away from the industrial fortress complexes, word spread about the wonders and power of Triax. Technicians, laborers, wizards and peasant families began to throng to them like a technological Mecca. These new arrivals sought the peace, knowledge and security of the world they had lost. Even some of the feudal kingdoms sent emissaries to Triax, acknowledging it as an industrial *kingdom*, and would later become part of the New German Republic.

The people living at the Triax industrial complexes had tried to maintain the lifestyles they had known before the ley line eruptions. They had all the modern amenities of electricity, indoor plumbing, personal vehicles, synthesized and natural foods, cybernetics, medicine, science and education. They built schools, hospitals, apartment complexes, parks, and a high-tech army. The corporation operated as a democratic republic with efficient business structure and a minimum of bureaucracy. Yet despite all of this, they had never thought of themselves as an autonomous society.

By the end of the first century of the Post Apocalyptic Dark Ages, the Triax industrial complexes were looked upon as the heart of a new Germany. Every day more people arrived in search of leadership, direction and security. Triax had become far more than a builder of machines or the holders of technology. It had become the blueprint for the future. The corporate and community leaders at the Triax facilities accepted the challenge of building a new Germany greater than anything in history.

In less than a century, the foundation for the New German Republic had been strongly established. At first, the new Germany was clustered around the Triax industrial zones, but over the course of the next hundred years, expanded and reached new heights of achievement. New cities sprung up everywhere. Away from the cities, especially in the more remote areas of wilderness, low-tech villages came to life and civilization prospered throughout the nation. By the advent of the Post Apocalyptic calendar established by other world powers crawling out of the Dark Ages, the NGR was a flourishing superpower. Without question, it was the first of the new nations to rise from the shadow of the Dark Ages. By 55 P.A. (Post Apocalypse), The Coalition States in the Americas along with several other fledgling human nations, were also beginning to stretch their muscles. If any place on Earth is a reflection of Pre-Rifts civilization, it is the New German Republic.

Despite the early achievements and grandeur of the NGR, few people knew about its existence. The appearance of monster ridden Atlantis, the Bermuda Triangle and dimensional disturbances over the Atlantic Ocean completely separated the European continent from the Americas. Furthermore, the resurrection of other human technology would be at least 200 years behind the NGR. It would not be until the year 60 P.A., when Triax first contacted the newly born Coalition States, that the people of North America would learn about the NGR.

The rest of Europe was much less fortunate than Germany. Except for a few isolated pockets, the continent was decimated. Cities were pulverized or washed into the ocean. Less than 2% of the people survived and half of those fell victim to starvation, disease, the elements, or the demonic forces that would soon sweep the land. Germany may have been free of monsters in those early years, but much of the rest of Europe was engulfed by them.

Even before the Coming of the Rifts, the British Isles, France, Spain, Scandinavia and much of Europe had a long history of myths and legends concerning magic, gods, ghosts, demons and faerie folk. The British Isles, France and parts of Spain were dotted with hundreds of mysterious, prehistoric, stone megaliths. Across the Mediterranean Ocean, giant stone pyramids continued to fascinate modern historians. All stood as mute testament to an earlier, forgotten age of magic. Unknown to modern man, they also indicated the flow of ley line energy, the location of nexus points and mystic epicenters. Like Pandora's fabled box, millions of supernatural predators, entities, fiends and monsters poured out of the many rifts that appeared at ley line nexus points, transforming Europe into a haven for supernatural forces. Unknown to the NGR, they were being surrounded by powerful evil creatures.

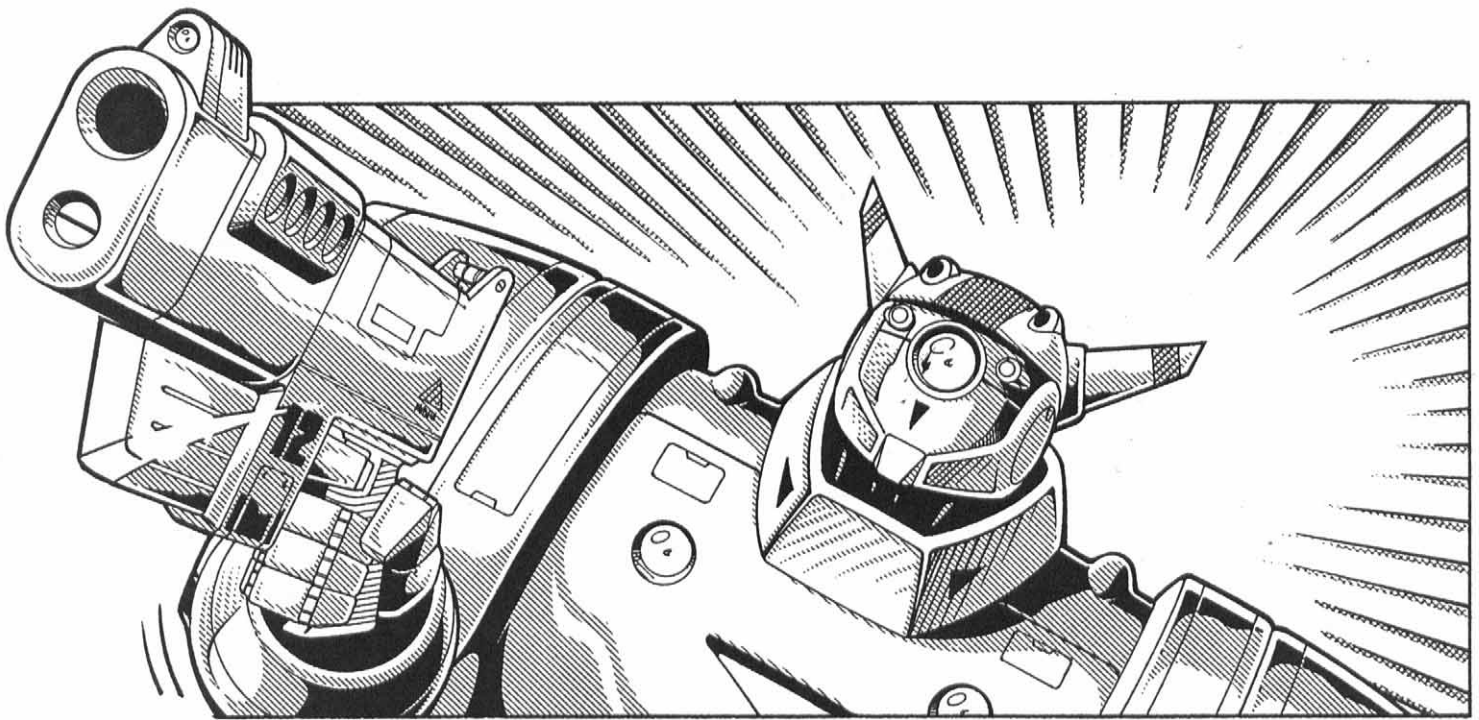

The Bloody Campaign

For a long time, the NGR had little trouble from supernatural menaces. The Black Forest was the only immediate area within its borders that teemed with faerie folk, poltergeists, werebeasts and demons. The occasional monster would cause trouble, but the police and military soon learned how to handle these disturbances. It was the smaller, outlying villages and farm communities away from the fortress cities that were most vulnerable and suffered the worst. As supernatural disturbances slowly increased, the NGR responded by upgrading their military and fortifications. The slow escalation of violence prompted the government and Triax to keep several paces ahead of the dangers that threatened them. It was not until the gargoyle invasions of 3 P.A. that the NGR decided to launch a full military campaign against the inhuman hordes.

Like the humans' ancient barbarian ancestors, tribes and clans of gargoyles, brodkil and other intelligent monsters pillaged the countryside with increasing frequency and growing numbers. For the most part, the inhuman invaders were no match against the Triax war machines and were easily dispatched. Still, they were becoming a serious problem. In response to the cries of its people, the government expanded its military campaign against the monsters. The plan was to deliver such a show of force that the enemy would flee and never return. The less technologically advanced and more frequently beleaguered Poles welcomed the action and invited the NGR troops to purge their country of the monsters as well. Recognizing their close proximity to monster ridden Poland and with brazen confidence, the NGR agreed.

To the humans and their robot legions, the so-called demons were not recognized as valid life forms, but as evil, hell-spawned abominations bent on the destruction of humankind. The soldiers saw only demonic predators that needed to be destroyed. The next five years was one of the worst campaigns of destruction since the Great Cataclysm. The bloodiest of these battles were waged in the Polish wilderness. Hundreds of thousands of gar-

goyles, monsters and monstrous D-bees were erased from the face of the planet. Entire tribes were slaughtered without mercy.

The campaign was a complete success. The enemy was soundly defeated and pushed beyond the Alps and far to the south. The NGR and Triax was confident that no inhuman force would ever dare to threaten them again. Indeed, peace reigned for the next 30 years. Only tiny bands of demons, lone hunters, thieves, and friendly D-bees encroached on German soil.

In 14 P.A. there was a brief outbreak of violence at the claws of vampires. The undead had made a push from Romania into neighboring Poland and among some of the German border villages, but it was put to a quick stop and the vampires were destroyed. There was intermittent trouble from the occasional menace that crawled out of the Black Forest or from monsters migrating from distant places that had never heard of Triax or the NGR, but always the enemy was easily rebuffed.

Around 20 P.A., the NGR began to hear rumors about a Gargoyle Empire, but as long as the beasts kept their activities restricted to the distant south (Italy, Yugoslavia and the Mediterranean regions), the NGR ignored them. Intelligence data suggested that this Empire was nothing more than a collection of many tribes and clans that constantly bickered amongst themselves. As usual, the monster hordes were said to be unorganized, undisciplined, and completely reliant on brute strength and superior numbers. The only areas of concern dealt with users of magic, dragons and the other powerful supernatural beings who occasionally associated with the lesser denizens of evil. The NGR smugly sat back, confident that the monsters would remember the Bloody Campaign and give the nation a wide berth. They were only partially correct.

One sleepy February morning in 38 P.A., the shrieking battle cry, "Remember the Bloody Campaign!" shook the snow from the rooftops. In an exercise of retribution, the gargoyles and their minions swept down upon the unsuspecting humans. The giant gargoyles filled the skies. Some reports insist that they were so numerous that the flocks of demons blocked out the

sun. On the ground, the wingless gurgoyles and other demonic minions washed over the land. Creatures of magic summoned terrible storms, brought mega-damage lightning crashing from the heavens, and conjured forth the fires of hell. Forests burned, cities toppled and people of evil joined the frenzied combat. Everywhere the battle cries of "For those who died before us," "Remember the Bloody Campaign," and "Death to all humans," echoed in the air like thunder.

The Gargoyle Empire trampled over the countries once known as Belgium, Switzerland, and Austria. Millions fled. Millions more perished. Over the next decade they would invade portions of Poland, Hungary and Czechoslovakia. Poland, where the bloodiest battles of the NGR occurred 30 years earlier, would again be party to the worst bloodshed; only this time it would be human and D-bee blood that washed over the countryside. Eventually, the brodkil would claim Poland as their domain and hold sway over it till this day (103 P.A.). Much of Hungary, Czechoslovakia, Romania and Yugoslavia would become a dangerous wilderness dominated by scattered tribes, kingdoms of monsters and men of evil nature.

The main objective of the Gargoyle Empire was the conquest of the New German Republic.

The Birth of Human Supremacy

Human cities were burnt to the ground and millions of humans and D-bees were slaughtered and enslaved (sold to dimensional slavers, the New Phoenix Empire and Atlantis). This campaign of destruction raged for seven years before the tide waned. Only the New German Republic stood unshaken, suffering fewer than 10,000 casualties and delivering unto the gargoyles 40 times that number.

The NGR became a symbol of human strength, perseverance, defiance and ingenuity. Nearly five million human refugees from the neighboring territories fled to them in droves. Poles, Austrians, Hungarians, Czechs, and others, sought salvation from the invincible German nation. For every one human there were three D-bees. It was the mass of all these people that taxed the NGR's resources to their limit and caused it to buckle under the weight. Refugee camps and shanty towns sprung up everywhere. As the number of refugees grew, the citizens of the NGR began to suffer from plagues, food and supply shortages, crime, enemy infiltration and sabotage. It soon became apparent that the NGR could not save everybody.

Pressed by the needs of so many, the NGR made a decision of historic consequence in favor of human supremacy. Human supremacists had spread their words of hate, fear and paranoia regarding non-humans for generations, but the government had allowed loyal D-bees to live in their cities and establish villages within the safety of the NGR's borders. Now, faced with the hardships of war, civil unrest, panic, and the plight of so many different people, the NGR turned its back on non-humans.

All non-human refugees were separated from the humans and forced out of the country. Those who resisted expulsion were beaten or killed. When the D-bee citizens of the NGR protested this brutal action, they became the next target. The D-bee populations of entire cities and villages were taken from their homes (forcibly if necessary), transported beyond the border of the NGR and left in the wilderness to fend for themselves. The evacuation and expulsion of non-human citizens was performed

as peacefully as possible under the circumstances. D-bees with the resources to do so, were given the opportunity to make arrangements for themselves. They could take most of their personal possessions and wealth other than land, homes, businesses, machinery, livestock, and surplus materials. The less financially capable majority were escorted out of town by the military with whatever they could carry. Looters, vandals, criminals and vigilantes, whether D-bee or human, were executed on the spot.

Approximately 3.4 million D-bees were displaced. Five million human refugees took their places, occupying ready-made homes and managing established businesses. Of course, new homes had to be built to accommodate the larger human population, but they got a big head start from the "reacquired" homes of the deported ex-citizens. A small percentage of loyal D-bee citizens (approximately 250,000) were allowed to establish new villages along the most remote and hostile areas along the borders. However, they were no longer "citizens," but identified simply as D-bees or "The Border People." None of the displaced D-bees were given any assistance whatsoever from the NGR. After their citizenship was revoked and they were sent away, the D-bees had to rely on their own resources, cunning and abilities to survive.

The NGR — 103 P.A.

The Battle Continues

Sixty years later, the New German Republic is still undaunted and prospers. It remains a Mecca for technology and a haven for humans. Many times the inhuman enemy has tried to invade the NGR and each time it has survived all attacks. Alternately, the NGR has successfully waged many campaigns that pushed the enemy far beyond its domain, but always the monsters return. Small conflicts and skirmishes within and beyond its borders are a daily event. This 60 year teeter-totter war has been a stalemate. Whatever the one gains, the other eventually wins back. However, in recent years, the NGR (currently strong and holding the upper hand) has begun to worry. The enemy continues to grow in numbers and ability. New forces, like the Gene-Splicers, Mindwerks/Angel of Death, and the New Phoenix Empire, have joined the battle. They conspire against the NGR and provide the gargoyles and brodkil with modern energy weapons, bots, bionics, and mind implants.

The demons who once relied entirely on brute strength and supernatural powers are beginning to recognize and use technology. The barbaric enemy grows sophisticated in the strategy of combat and the use of modern weapons and machines. Already half of the monsters have added energy weapons, explosives, sensors, cybernetics, and vehicles to their arsenal of magic and supernatural powers. There are persistent rumors that the gargoyles have developed (or more likely, been given) giant robots to counter Triax's mechanical marvels.

A Call to War

While the forces of the NGR currently remain undaunted and the advancements of Triax are unrivaled, the question still arises, "How long can the NGR expect to play this teeter-totter game before they finally fall before an increasingly versatile and pow-

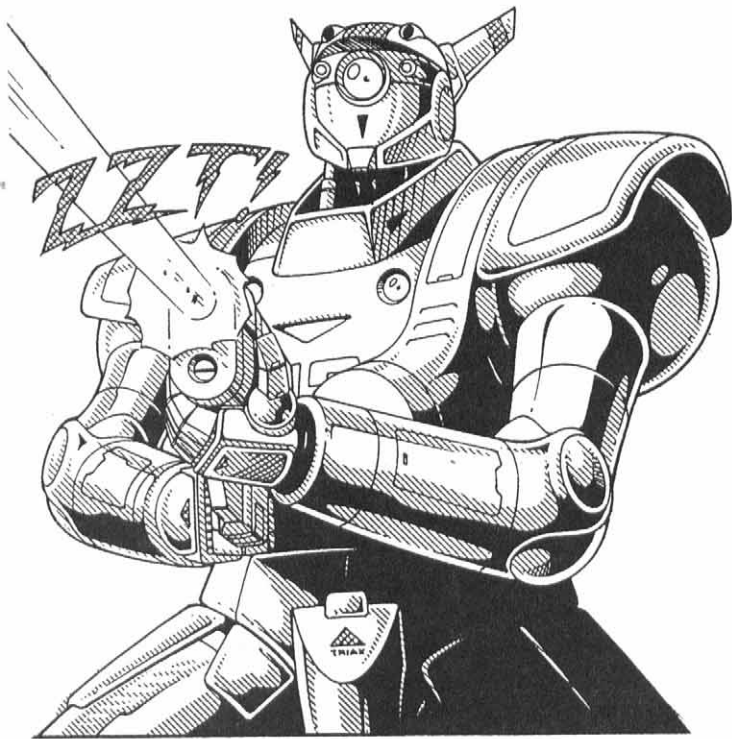

erful enemy?" As a result, the NGR and Triax have been preparing to launch another assault against their supernatural nemeses. A devastating and relentless assault that will make the Bloody Campaign of 3 P.A. pale by comparison.

To this end, the NGR has spent the last 15 years building on human fears and hatred of non-human monsters and aliens in general; and specifically gargoyles, brodkil and so-called demons. The NGR's human troops have been increased by 10 fold and any new refugee who is a healthy male or female of reasonable age, must pledge eight years of military duty to be allowed into the NGR. At the age of 17, all male citizens born in the NGR must serve five years in the military or six years as a laborer/technician at a Triax manufacturing facility. All such laborers are paid minimum wage during that six year period regardless of advancement. Females are strongly encouraged to join the military or a Triax facility as a minimum wage earner before pursuing a career or family, but are not currently required to do so. It is interesting to note that minimum wage earners at Triax and soldiers in the military do receive excellent training and experience. The best workers are encouraged to stay on as valued employees at normal pay. The most common areas of training include electrical and mechanical engineering, weapon systems, robotics, cybernetics, chemistry and chemical analysis, and computer sciences (operation, programming, hacking and repair).

The NGR's preparations to engage in a potentially lengthy and costly war has been one of their motivations in reaching out to the Coalition States. The NGR's war will severely strain their resources. Thus, if nothing else, they need a strong ally who can supply them with food and raw materials to get them through the lean years that are likely to come. This has been why the NGR has not pressed the Coalition States for military assistance as part of the proposed alliance. The Coalition's political, social and economic strength, combined with their own policies of human supremacy, has made them the only viable candidate as a significant ally. However, the NGR is at a point where it

cannot wait much longer for the CS to make up its mind. With or without the support of the Coalition States, Triax and the NGR will launch its military offensive within the next twelve months.

Note: Also see the section on the military, robots and war machines for details concerning specific weapons and equipment.

The Coalition States & The NGR

The Coalition States have sent politicians, diplomats, military specialists, and businessmen to the New German Republic. These welcomed emissaries have conducted formal investigations into the operations and stability of the NGR and to discuss proposals regarding trade and diplomatic relations. The ever cautious CS has also dispatched several spies to conduct secret explorations into the inner workings and motivations of the Republic. The following report is from one such espionage agent.

Summary Report

From Intelligence Operative G15

"My previous intelligence reports are an accurate representation and assessment of the situation within the New German Republic. The NGR has bots and borgs that far surpass anything the Coalition has in production. Some of the war machines tower over 30 feet tall and possess the firepower of an entire CS armored squadron. Their mastery of robotics is at least 10 years ahead of the CS. Furthermore, rumors suggest that Triax is successfully experimenting with an anti-gravity propulsion system pirated from a captured alien vessel.

"Triax Industries is a corporate power separate from the government that dominates German industry. I know that Emperor Prosek has expressed concern regarding Triax's influence over the government, but those concerns are unfounded. There can be no question that the power of this corporation rivals that of the President of the NGR. However, Triax Industries is completely loyal to the NGR and dedicated to the advancement of human supremacy. Triax and the German government are virtually one and the same and share the same goals. Both work as one. The autonomy and strength of Triax should not be a concern.

"I am aware that the technological superiority of Triax and the NGR is also of considerable concern to the military leaders of the CS. There is no doubt that Triax is an industrial and technological giant without equal. The bots and technology released to the Coalition States and other kingdoms are only a minuscule fraction of their true level of advancement. Using a basic scale of one to ten, with ten being the highest level of achievement and one the lowest, Triax is a ten. By comparison, the Coalition States and Atlantis are a seven, while Northern Gun and the Manistique Imperium a mere four or five.

"I do not see a hidden agenda behind the New German Republic's proposal for a diplomatic alliance. I am convinced that they have no desire to usurp the power of the Coalition States, but seek to empower, protect and advance all of humankind. To those dissenters who point out that Triax has refused to provide the CS with their most advanced creations under our current, limited trade agreement, I ask you, would we not do the same?"

The Quest for an Alliance

As a military officer, I see their hesitation to share their most coveted advancements as a strategy to entice the CS into a more comprehensive and favorable alliance. If they did not hold back, they would lose their leverage in these negotiations. Furthermore, in the absence of a formal alliance, the Coalition States represent a potential hostile force as both a military and manufacturing power.

"The people of Germany are locked in a war against an unyielding enemy of overwhelming number and unnatural strength. It has been the NGR's technological superiority that has enabled them to withstand the invading monsters. It is a testament to their human ingenuity and courage that they not only survive amidst incredible adversity, but have managed to build a thriving empire. They are not likely to give away the secrets of their strength so cheaply.

"It is this operative's opinion that the Coalition States seriously consider a strong diplomatic alliance with the NGR. I am confident that the German leaders will live true to the covenants set forth in such an agreement. The advantages of this alliance will far outweigh the potential for danger. Even ignoring the tremendous scientific and technological advancements that this alliance will make possible, it is imperative that humans around the world work together.

"I further suggest the terms of the alliance should be strengthened to include the full military support of the NGR. In my opinion, if the NGR should ever fall to the Gargoyle Empire, Brodkil or Splugorth, it will mark the beginning of the end of human life on Earth. If the supernatural demons conquer a power such as the NGR, it can only make the inhuman hordes bolder and more bloodthirsty, as well as vastly more powerful. With the NGR and Triax gone, they will most certainly turn their attention toward the Coalition States.

"I have witnessed these monsters' hatred. They are dedicated to the eradication of human life from the face of the planet. I have witnessed, firsthand, their use of modern, man-made weapons and devices. The conquering horde will use the technology captured from Triax to make themselves all the more powerful. Do not underestimate the demon legions of Europe. Unlike those in the States, they turn to alien forces to build their war machines equal to the bots and armor of Northern Gun. They have begun to learn the ways of human science and how to use it against us. This is a new breed of monster that must be destroyed before they destroy us with our own weapons. The NGR recognizes this danger but cannot crush the enemies of humankind by themselves. Consequently, I again advise full diplomatic and military support of the New German Republic.

"Phase two of my mission is the infiltration of a subversive organization within the NGR. I make this summary report before I enter into deep undercover. It is my present assessment that these subversive forces have little influence on the government or stability of the NGR. Furthermore, these malcontents should have no effect on any treaties the NGR and the CS may enter into. I will be able to provide a more accurate appraisal after I penetrate one of these organizations. My primary target is **The Unmutuals**, one of the most talked about (though least militant) groups of subversive deviants and free thinkers. The notorious Victor Lazlo is also loosely affiliated with this organization and it may provide me with the opportunity to infiltrate his underground organization."

Intel. Op. G15

Transmission Priority A-3 SCRAM; December 9, 103 PA

The New German Republic and the Coalition States have known about each other's existence for decades, but it has only been in the last ten years that any measure of trade and diplomatic relations have been established. It was the **New German Republic** (NGR) who made the first overtures for diplomacy. It was the NGR who has proposed a formal alliance between the two technological superpowers and patiently waits for the Coalition States to accept its hand in friendship. Not surprisingly, it has been the influence of **Triax Industries** that has nudged the Coalition closer to entering into a formal alliance with the NGR. Triax has engaged in the trade of robots, cybernetics and supplies with the five Coalition States, the Manistique Imperium and Northern Gun. Triax has also engaged in the (albeit, very limited) exchange of science and technology exclusively with the Coalition States. This friendly gift of data has accelerated the Coalition's efforts in the area of advanced cybernetics, robotics and weapon systems.

On the other hand, Triax has also unwittingly or indirectly sold weapons, bots and power armor to independent kingdoms and anti-Coalition forces. A regrettable situation that has sent mixed signals to Emperor Prosek and has given cause for the CS to question the New German Republic's and/or Triax's motives and reliability. The Coalition also views the independence and power of Triax Industries with a certain amount of apprehension.

As a result, the Coalition States have politely declined all offers for a formal, diplomatic alliance with the New German Republic while maintaining lines of communication and limited trade. The Coalition has three primary concerns in entering into any type of diplomatic commitment with the NGR.

One: Fear of being drawn into a war overseas. The NGR has agreed to assurances that the alliance would NOT include direct military support by the CS. Still the Coalition hesitates. Some advisors insist that even a trade and information alliance will almost certainly make the Coalition States a target for assassins and terrorists from the Gargoyle Empire, local sympathizers or Atlantis. It is no secret that Atlantis discretely supplies and supports the Gargoyle Empire, raising the question of whether or not an alliance between the CS and the NGR would provoke Atlantis to make a similar alliance with the Gargoyle Empire. Such an alliance would dramatically escalate the war in Europe and very likely bring it to the Americas. A war the Coalition States believe they can ill afford at this point in time.

Two: Escalation of hostilities. Would the alliance provoke acts of aggression by gargoyles and other monsters in the Americas? Wouldn't the monsters rise up against the enemies of their European brothers? It has also been suggested that such an alliance might make other, unallied, and presently peaceful kingdoms unite against the CS and NGR for fear that these two superpowers would strike them down in a bid for global conquest. On the other hand, many of the smaller independent kingdoms might see the alliance as a positive event and draw them to become part of the two larger nations.

Third: The Coalition States are suspicious of everybody. They question the motives of their European counterpart. Some political leaders have suggested that full diplomatic ties is the first step in an NGR plot to conquer the CS by means of subversion and infiltration from within. A ploy to learn the strengths and

weaknesses of the CS and exploit them in their favor. However, it has been the Coalition States, not the NGR, who has a long history of expansion through military conquest.

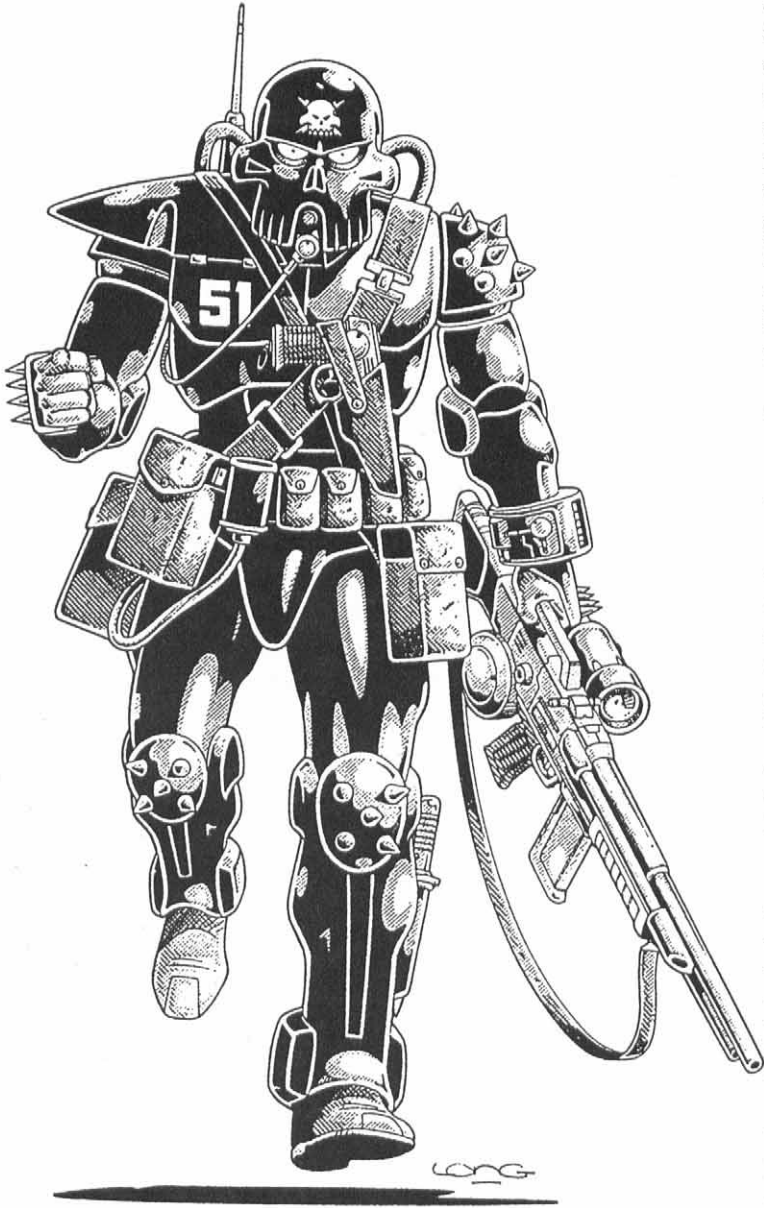

Another Perspective

It is interesting to note that the Coalition States view themselves as being terribly vulnerable to attack by supernatural and mystical forces. This view comes, in part, from the Coalition's general feeling of extreme paranoia toward non-humans, the supernatural and magic. In reality, the Coalition is far more stable and secure than the New German Republic. They are firmly entrenched in the parts of the old American and Canadian Empires that they control. Hostile forces in North America are relatively small and impotent when compared to the unrivaled level of technological superiority possessed by the CS in that part of the world! Furthermore, should the continent ever be invaded by enemy forces, independent kingdoms such as Northern Gun/Ishpeming, the Manistique Imperium, and even Lazlo and Tolkeen, would join in the fight to save their domain. Compared to the constant turbulence that threatens the New German Republic, the Coalition States are as strong as a mountain.

As for **Atlantis**, it is unlikely that Lord Splynncryth would ever declare war on any other major power. For one thing, it's just not how Lord Splynncryth operates — deception, corruption and treachery are more his style. It must be remembered that the Splugorth are completely self-serving. Declaring war against either the NGR or the Coalition States is simply not in the best interests of Atlantis. From Lord Splynncryth's perception, the war between the Gargoyles and the NGR has created a viable market for the sale of weapons and equipment and the acquisition of slaves and salvage. Secondly, the conflict has provided years of delightful entertainment, betting, and intrigue. Consequently, the Lord of Atlantis will fan the flames of war and discontent, but will never send Atlantis into the fray itself (he'll back down if it comes to that). The only thing that is likely to change Splynncryth's position is if Atlantis is attacked.

The Motives of the NGR

The New German Republic would like to establish an alliance with the Coalition States for three main reasons.

One: To send a very loud and clear message that they do not stand alone. Even a trade agreement with the Coalition States should give their enemies pause. The CS is famous for their military superiority and hatred of non-humans. To have such a technologically advanced military powerhouse at their side would make the NGR seem even more dangerous and undefeatable. They hope such an alliance would shake the confidence of their enemies to such a degree that some might give up the fight and direct their attention to more vulnerable targets elsewhere in Europe.

Two: Establish a supply and support line with a powerful and reliable ally. A lengthy campaign against the enemy will deplete the available resources of the NGR and Triax. An alliance with the Coalition States would replenish dwindling supplies and keep the morale of the people high. The CS would be especially helpful in providing food, cybernetic and robot components, raw materials and medical aid.

Three: To unite the two human superpowers in their struggle to reclaim the Earth for humankind. Although the New German Republic has not exhibited the Coalition's penchant for expansion through conquest (mainly because of powerful enemy forces and constant turmoil), they are firm believers in human superiority. They wholeheartedly embrace the Coalition's efforts to eradicate supernatural beings and monstrous life forms from the planet. Once the NGR has crushed their enemies they will support the Coalition's campaigns of conquest and genocide in North America. As a matter of fact, the NGR sees the xiticix in the same light as the gargoyles: a growing empire of monsters that threatens humankind and which must be destroyed.

The Terms of the Alliance

The main elements of the proposed alliance guarantees the following:

1. A non-aggression agreement between the two superpowers that also establishes the limitations and formalities for joint trade.
2. Limited Triax exportation of robots, cybernetic components, body armor, power armor and weapons exclusively to the CS, Northern Gun and the Manistique Imperium; all of which must be acceptable to the Emperor of the CS.

3. An exchange of technology and science exclusively with the Coalition States and coordinated through Chi-Town.

4. Virtually unrestricted exportation of food, raw materials, and component parts from the CS to the NGR.

5. Mutual access to CS and NGR secured trade routes.

6. Military escorts and protection once convoys have reached a trade zone controlled by each respective party.

7. Specific commercial services, limits and regulations.

8. The time period of the initial agreement: 8 years, with six year renewals and options to expand the time period, terms, conditions and trade limitations, subject to the mutual consent of both parties.

Note: The NGR had originally asked for a 20 year agreement with 15 year renewals. The NGR would also like to see expanded trade and a mutual military allegiance.

This is just the beginning of a *possibly* extensive and long lasting alliance between the two nations. Non-humans and small independent kingdoms fear such an alliance will lead to an aggressive and unified campaign of military invasion and conquest on both continents. Some have gone so far as to state that the ultimate purpose of the alliance is the establishment of joint global domination by the Coalition States and the New German Republic. However, it would seem that any significant steps toward uniting the Coalition States and the New German Republic are at least a year or two away. Considering how paranoid the CS leaders are, it may never happen, but the first few steps have been made.

Embassy for the Coalition States

The NGR has established a diplomatic base of operations for dignitaries from the Coalition States. This is a lavish and splendid facility deep within the protective confines of the capital city. Each of the Coalition States have their own area within the facility.

Currently, the average State has a dozen ambassadors and observers stationed at the embassy in the New German Republic. The States also send other notable visitors, such as manufacturers and scientist, to visit and explore the wonders offered by the NGR. However, few visitors seldom stay for more than a month before returning home. The only exceptions are **Chi-Town**, which has its own embassy, 24 diplomatic ambassadors and 60 troops (including 12 sky cyclists, 24 SAMAS pilots, 12 dog boys and 12 military specialists), and the **Coalition State of Free Quebec**. Quebec has a diplomatic team of 36 ambassadors, 24 scientists, 48 observers/advisors and a defense force of 24 Glitter Boys (provided by and manufactured in the NGR) as its permanent contingent.

Free Quebec & The NGR

Of the five Coalition States, Free Quebec is the strongest advocate for an alliance with the NGR. They have gone so far as to establish a special technologies trade agreement independent of the other Coalition States. Under this agreement, Free Quebec has given Triax the manufacturing secrets to build the laser resistant power armor used by the Glitter Boys. A military secret Quebec has not seen fit to share with its fellow States! In return, the NGR has increased the trade of advanced cybernetics,

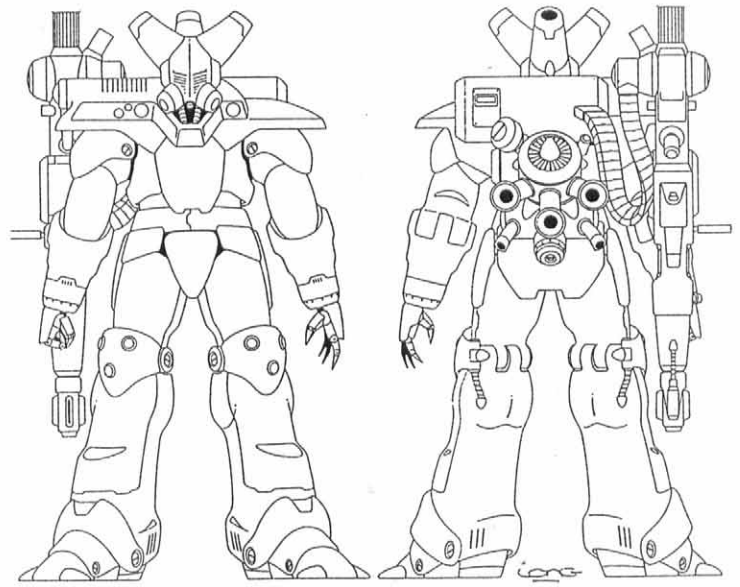

cybernetic technology and has agreed to deliver 144 USA-G10 type Glitter Boys by the Spring of 104 PA. In addition, Triax has promised to deliver 60 of its *new*, streamlined version of the Glitter Boy, the **Triax T-550 Glitter Boy** (a creation made possible only from the exchange of technologies with Free Quebec) by the Fall of the same year.

Although this trade arrangement may sound fair and equitable for Free Quebec, it has caused Chi-Town and the other remaining States to question the NGR's motives and trade policies, as well as Free Quebec's plans for the future. The Coalition State of Free Quebec has been at odds with the policies and edicts of Emperor Prosek for years. There is growing concern regarding their apparent disharmony with the rest of the Coalition and its views of autonomy. Free Quebec's agreement with Triax and the NGR only punctuates the mutual dissatisfaction between it and Chi-town. For example: Free Quebec had refused to disband its army of approximately 240 Glitter Boys. They have kept the GBs instead of switching over to the use of the standard CS combat units, such as the SAMAS and UAR-1. It was finally agreed that they could keep their Glitter Boys under the condition that they did not manufacture new units. The technologies exchange in which Triax is to build a total of 204 new Glitter Boys violates the spirit of that agreement.

Both Free Quebec and the NGR argue that the preexisting agreements with the CS have not been violated. They point out that the language of the covenant with Free Quebec did not expressly prevent the State from trading technologies and services with a friendly nation in exchange for goods, such as the additional Glitter Boys. Furthermore, the trade agreement with the NGR, a potential ally, does not in any way jeopardize the security of the Coalition States. Politics and rhetoric aside, Emperor Prosek feels betrayed by Quebec and is increasingly unhappy with their defiant and manipulative behavior.

Free Quebec's favorable agreement (and possible positioning for secession from the CS) has made the representatives from all the other States nervous, envious, or both. This has led to a sudden reconsideration of their position regarding an alliance with the New German Republic. As a result, political leaders are pressuring Emperor Prosek to sign the alliance. The other States want a piece of the high-tech pie and are afraid that Free Quebec or other world powers may cut them out of the equation. This is exactly the response Triax hoped their arrangement with Quebec would elicit.

Triax Industries

Manufacturing & Technology

There are a tiny handful of other manufacturers and developers of cybernetics and robotics, but without any doubt, Triax Industries is “The” manufacturing giant in the New German Republic. It is a mega-corporation that completely dominates 90% of the market in the areas of robotics, cybernetics (for both medical and military use), power armor, weapons, weapon systems, combat vehicles, aircraft, and energy systems. It is also a major force in communications, computers, electronics and commercial manufacturing, representing approximately 55% of those markets. Not surprisingly, the corporation holds the exclusive military contract with the NGR.

Triax is so powerful that its CEO serves as Vice President of the Republic and many of its corporate officers and stockholders have influential positions within the NGR government, including the Head of Defense. Many outsiders would contend that Triax is the government. However, the people of the New German Republic and its government servants are content with the organization and performance of their government. Triax officials have a long and illustrious history as benevolent leaders and visionaries dedicated to the people and who have made the NGR strong and prosperous. One must remember that the New German Republic grew out of the Triax corporate cities that survived the Great Cataclysm.

The corporation’s vast wealth, military and manufacturing power and direct connections to the government gives it an insurmountable advantage against all competitors. Ninety percent of the other, comparatively tiny cybernetics, robotics and weapon manufacturers are subsidiaries of or subcontractors to Triax Industries. In fact, most citizens refuse to purchase or endorse anything NOT made by Triax Industries.

Over the last 20 years, Triax has become increasingly aggressive in their marketing and sales of robots, power armor, cybernetics, weapons and electronic equipment to other predominately human communities. This includes selling to many of the small, independent kingdoms and wilderness communities scattered around them, as well as the humans in England, Greece, and most recently, the Coalition States and a few others in North America.

Trade to the Americas is difficult and dangerous because of its geographical location, dimensional anomalies and the supernatural.

In Europe, Triax Industries has an irrefutable reputation for manufacturing the best robots, power armor and weapons in the world. However, in the Americas, Triax Industries has not yet earned much of a reputation. Most people think of them as the producer of superior robotics systems and not weapons, cybernetics or commercial items such as vehicles jets packs, etc. Consequently, most natives of the North American continent will choose the comparatively inferior weapons and equipment of Northern Gun or the Manistique Imperium. Wilk’s is considered the premier weapon maker and is roughly equal in the area of laser technology. Most consider the weapons and equipment created for the military of the Coalition States to be state of the art technology.

Elements of Society

Cities & Technology in General

The New German Republic is an advanced society brimming with high-tech electronics, cybernetics, robots, vehicles and machines. The typical city is a megalopolis with an industrial and/or technology center. Most cities in the NGR and much of Europe are different than cities in the Americas. In America, Pre-Rifts population centers like New York, Chicago and Los Angeles were filled with skyscrapers 30 to 60 stories high — man-made mountains of steel and concrete inhabited by millions of people. Even with the advent of super technology, most of Europe stayed with what might be described to Americans as a sprawling “industrial suburb” or “high-tech village.”

These high-tech communities have sprawling factories, countless office buildings, high-rise apartments ultra-modern theaters, sports arenas, subways, monorails (electromagnetic trains), highways and even a few dozen 30+ story skyscrapers. However, most tall buildings seldom stand higher than 12 stories. The average office building stands about eight stories tall, factories four to ten, and even most of the Triax super-tech industrial complexes (which cover several city blocks — a few encompass several miles!) seldom exceed eight stories in height. This has been done for several reasons.

One, the lower buildings seem safer. They are a smaller target and more structurally solid. Two, being spread out means that the population is less concentrated in any one area and, therefore, less vulnerable to enemy assaults.

Three, there is an abundance of space. Much of Germany and Europe has been reduced to uninhabited wilderness.

Four, many of the Post-Rifts communities have expansive communities underground — like a three to six floor, underground subway station that just keeps going with its myriad shops, businesses and apartments.

Five, a deliberate intention to keep the stylistic look and feel of the traditional Germany — a village and chalet kind of look. Along these lines, there was a conscious effort to blend into the rustic beauty of the land. The builders didn’t want to obscure mountains or forest in the horizon with walls of concrete.

In the smaller communities, the architectural styles of 16th to 19th Century Earth have been carefully imitated, creating picturesque looking villages. From the outside, except for the occasional bot, hover vehicle or magnetic rail system, a visitor might feel transported back hundreds of years, to a time before the Great Cataclysm. However, one step indoors and that illusion is shattered. Even the small, pretty little cities, towns and villages have every modern amenity one can imagine, from computers and high-tech electronics to advanced communications and robots.

Personal computers are commonplace and computers of all kinds are visible everywhere. Electronic networks combine computers and telecommunications to provide the “communication super highway” heralded in the 20th Century. This communications network provides audio-visual communication, electronic mail, electronic news (TV style reports and newspaper style

written reports/books and graphics), data reports, stock information, bank data, train schedules, shopping, games, television (live and recorded entertainment), new and old films, music, library files with books, history, and just about every other feature one might expect from a modern computerized society.

Education

Ninety percent of the human population is educated, literate and skilled. The average citizen has the equivalent of a high school education, while those in the areas of education, medicine, science, communications, computers, and technology have the equivalent of college degrees. This is a striking contrast to most of the Coalition States where illiteracy among the masses is promoted and rogue scholars are hunted criminals. It is this level of education and the degree of personal freedom which concerns the Coalition States.

This means the average citizen has the following skills:

Language: Euro (+25%)

Language: Pre-Rifts German (+10%)

Literacy: Euro (+20%)

Basic Math (+15%)

Computer Operation (+10%)

Citizens without military experience have two attacks/actions per melee and can select three skills from one skill category reflecting a profession (all +10%), two other skills (+5%) and four secondary skills. The only skill categories not available include espionage, military, rogue, wilderness and weapon proficiencies. Additionally, they cannot select the skills of acrobatics, wrestling, pilot tank, and robot combat: elite.

Those with military experience, about 55% of the average males and 26% of the females, have the additional skills of:

Radio: Basic (+5%)

Running

Climbing

Hand to Hand: Basic

W.P. Energy Rifle

The Calendar

Although the NGR recognizes the Post Apocalypse calendar, it still uses the Pre-Rifts A.D. calendar. According to the NGR, the Great Cataclysm began on December 22, in the year A.D. 2098. Exactly 291 years have passed since the ley lines exploded and shook the planet. This means it is the year A.D. 2389. Generally speaking, the Post Apocalyptic Dark Ages lasted about 188 years. The new P.A. calendar starts with the end of the Dark Ages.

Note: Both calendars keep the same measurement of time, 24 hours in a day and 365 days in a year. They also use the same Pre-Rifts names of the months (January, February, March, etc.) and days (Sunday, Monday, Tuesday, etc.). In a game context it is late in the year 103 P.A.; probably October, November, or December.

Cybernetic Augmentation

Cybernetic augmentation is common and legal. Only weapon systems and concealed weapons are illegal. Even then, an individual can petition the courts for a permit to carry a concealed weapon (bionic or otherwise). Cybernetic implants and augmentation are common among people from all walks of life.

An estimated 65% of the NGR's population has some form of cybernetics. The most common are minor cybernetic implants for reasons other than combat; i.e., cosmetic or medical. Often these implants cannot be seen by the human eye and are used for information gathering and access or minor augmentation. Such implants are most common among city rats, wealthy students, the wealthy in general, business executives, merchants, and soldiers. In most cases, the person will have one to six items such as the cybernetic clock calendar, gyro-compass, radiation detector, bio-comp monitor system, internal comp-calculator, translator, universal jack, hearing aid, and similar.

Approximately 40% of the population has one or more bio-system or cybernetic prosthetic, eye, or organ (the price of war). 10% of the population are partial reconstruction borgs and another 15% are full conversion borgs; most are ex-soldiers, mercenaries or adventurers. This is in addition to the cyborg soldiers currently under active service in the NGR military (approximately 33% of the armored division of the military is composed of full or partial cyborgs).

M.O.M Conversions are Illegal

The old science of Mind Over Matter via brain implants and neural stimulus is illegal in the NGR. This is the process that creates the character commonly known as a "Crazy." Operating an underground MOM Shop is a capital offense and a war crime. First time offenders are imprisoned for 3D4 years. Repeat offenders are executed.

The military is constantly tracking down and destroying MOM Shops and often shoots to kill. This is not only acceptable conduct but applauded, because MOM installers are considered to be inhumane war criminals. Characters with MOM implants are considered dangerous human time bombs and are not allowed into the NGR without government clearance. Such approval is difficult to acquire and is provided to only known and trusted mercenaries, allies and foreign dignitaries working with the NGR or Triax. Crazies who sneak into the nation are captured and deported. Alternately, their MOM implants may be forcibly removed. This is a terrifying and dangerous alternative because removal of the implants frequently results in additional and permanent insanity (01-30; roll for 1D4 additional), permanent brain damage and memory loss (31-60), paralysis (61-90; one limb is paralyzed), or death (91-00)!

There are several reasons MOM implants are illegal. For one, the procedure causes severe antisocial behavior, hyper-activity and a large number of serious mental and emotional conditions. In 70% of the cases, the mental condition of MOM recipients continues to get worse with the passage of time, becoming a danger to himself and those around him. Furthermore, the brodkil and other monsters have been subjecting themselves to MOM conversion to better prey on humans or to better fight the NGR. The monsters see sideeffects that increase aggression, paranoia, psychosis, and other insanities as a good thing, making the warrior even more ruthless and unpredictable in combat. They see insanity as an asset and the savage beasts are antisocial to begin with. It must be pointed out that most supernatural creatures cannot use MOM implants or bionics because of their superhuman nature. Regenerative abilities and magic powers reject and/or negate mechanical augmentation. In other cases, cybernetics, of which the MOM process is a derivative, prevents a character

from summoning and using magic energy and is thus avoided. It is the lesser beings and the so-called sub-demons, like the brodkil, gurgoyles, gargoyles, and monstrous D-bees, who are most inclined to try MOM conversion and bionic experimentation. The brodkil, in particular, love bionic and MOM enhancements.

Reconnaissance and rumors indicate the existence of a manufacturer or kingdom known as **Mindwerks** that is supplying the enemies of humankind with the MOM implants and bionics. Before the Great Cataclysm, there was a company known as Mindwerks and it was a pioneer in Mind Over Matter (M.O.M) systems and cybernetic technology. Until 2071 it was larger than Triax. However, it fell into ruin when sued by thousands of MOM recipients, their families and even governments when it was proven that severe mental and emotional damage were the inevitable and usually irreversible side-effects of MOM augmentation. The last floundering remnants of Mindwerks is believed to have perished during the Great Cataclysm. The Pre-Rifts MOM technology has been lost in Europe and Triax Industries will have nothing to do with this debilitating area of mental enhancement (even the Coalition has banned it, although the technology still exists in the Americas).

At this point, the NGR military and independent Triax investigators have been unable to locate this “new” Mindwerks. Considering 40% of the brodkil, who dominate southern Poland, have MOM implants and an additional 20% have partial bionics, most officials believe Mindwerks will be found in Poland. Some believe it is in or near the old city of Krakow. Rumors also suggest that the power behind the Mindwerks operation is a beautiful woman whom the brodkil call, “The Angel of Death.”

Juicer Technology

Chemical augmentation is not illegal in the NGR, but is not used by the military or Triax (both rely heavily on bionics and robotics) nor encouraged by the government. The average citizen has been taught the hazards of chemical augmentation and the vast majority (88%) avoid it. However, **Juicer Technology** flourishes in and around the NGR. It is especially popular among mercenaries, warriors, city rats, bandits, foreign armies and adventurers. **Note:** Also see the Euro-Juicer O.C.C. description in this book.

Law Enforcement

The military soldiers serve as the police force in the New German Republic. War crimes and criminals, including subversives, terrorists, secret agents, and refugees, are under the jurisdiction of the military and dealt with entirely (and harshly) by the military.

Criminal and civil disputes, disturbances and crimes are ultimately under the jurisdiction of the local or federal court system. The military soldiers assigned to police duty investigate reports of trouble, make arrests and enforce the law. The suspects or perpetrators are delivered to the local judiciary where they plead their case, go to trial, get sentenced (fines, probation, prison, etc.) and find justice. Crimes and punishment are very similar to those of the 20th Century.

Justice in the cities and villages within the territory claimed by the NGR is usually quick and fair, unless one is a D-bee. However, in the villages and kingdoms outside the NGR, justice

can be hard and brutal, if it exists at all. Often times, wilderness justice belongs to the individual or group who gets there first or who is the strongest or meanest. Likewise, justice and fairness will vary greatly depending on who is dispensing it. Even the NGR military will play fast and loose with morality, justice and mercy in the wilderness, depending on the stress of the circumstances. Most humans are particularly cruel and intolerant of bandits, gypsies, D-bees, and supernatural monsters.

D-Bees of the NGR

The D-Bee Population of the NGR Today

Over the years, an estimated 1.5 million D-bee refugees and squatters have snuck back into the wilderness areas of the NGR. Here they eke out a modest existence as farmers, hunters, woodsmen and gypsies. Except for troublemakers and suspected enemy conspirators, the NGR turns a blind eye to their presence (perhaps indicating some modicum of compassion toward other life forms after all).

The D-bee population along the NGR’s war torn borders has escalated to approximately 700,000 — a number that alarms some people; particularly the human supremacists.

An additional 200,000 D-bees can be found scattered throughout the cities and the occasional villages of Germany. They are considered Foreign Nationals and employed as a cheap, expendable labor force. Only the largest or richest industrial communities employ non-human workers. All D-bees living and working within the NGR must register with the government and make monthly appearances at their local Office of D-Bee Affairs. Failure to report without an exceptional excuse will result in a lengthy interrogation and investigation. Any conviction for crimes or collusion with the enemy will lead to imprisonment, permanent expulsion or execution. Deported/expelled D-bees who illegally return risk imprisonment and/or execution.

Employers of D-bees are expected to keep a close watch over their inhuman employees. Furthermore, employers of suspected spies are interrogated, their business placed on six month probation, monitored by the intelligence agency of the military, fined with stiff penalties for reckless endangerment, and all the other workers are watched closely by the military. Convictions of conspiracy or organized crime bring long prison terms or execution.

Note: No D-bee can ever become a citizen of the NGR. Although a tiny number are allowed to live and work within its borders, they are never allowed to become citizens.

- All D-bees must register with and report monthly to the Office of D-Bee Affairs. They are photographed, fingerprinted, retina scanned and placed “on file.” They can NEVER become citizens.
- D-bees are paid a quarter of what their human counterparts receive, regardless of the character’s level of skill and ability.
- D-bees are treated with indifference, suspicion and cruelty by the majority of humans. Police and soldiers tend to regard them as the enemy and they are the first to be suspected of local crimes.

- Most human citizens avoid having anything to do with D-bees. The odds of an average citizen coming to the assistance of a D-bee is one in forty.

The Outskirts of the NGR

As one moves away from the cities and human population centers, the atmosphere becomes darker and more glum. There is a palpable tension and fear in the air. The outlying communities are small to medium sized villages. Some are factory towns guarded by the Army of the NGR, or an independent militia, but most are small villages: communities of farmers, trappers, woodsmen and fishermen.

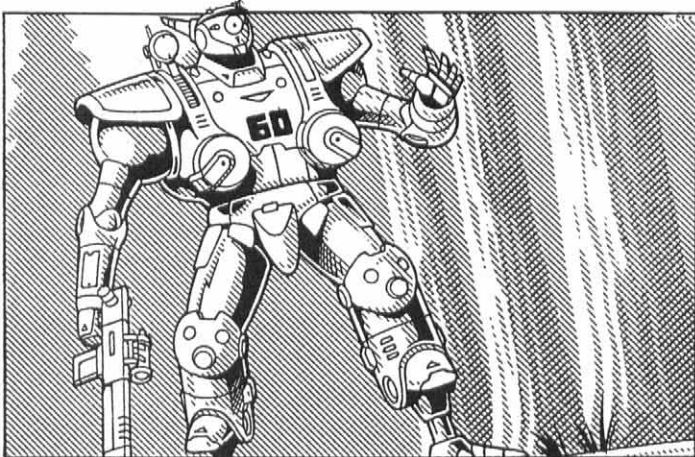

The military sends weekly or bi-weekly patrols to visit and secure the outlying areas, stopping to inspect, protect and assist communities occupied entirely by humans. The soldiers are quick to investigate calls for assistance, reports of suspicious activity or trouble by non-humans, and reports of enemy attack. The Army boasts that it can deploy a full, armored division to any location within its borders within 5 to 20 minutes. Note that a powerful supernatural attacker can destroy half a village in that time, and slip into the night before help arrives. However, to do so, the attacker must penetrate the well patrolled perimeters of the NGR's borders; an impossible task for any large number of troops.

All human villages have a communications center. This may be an official arm of the NGR government, military, or a village militia. It can be located in a government building, radio tower, or left in the hands of a civilian volunteer with a shortwave radio in his basement.

The neighboring D-bee communities are not so fortunate. Generations of war, pain, and fear have made many of the humans bitter, angry or indifferent toward non-humans. Too many humans treat D-bees like worthless animals to be used and abandoned when they have outlasted their usefulness. The plight of the D-bees who suffer at the hands of the Gargoyle Empire and other forces of evil fall upon deaf ears and frozen hearts. Innocent and helpless D-Bees are forced to live in the so-called "Monster Zones."

The NGR military treats all non-humans as "hostiles." They may send fly-by patrols or ground reconnaissance teams to keep an eye on D-bee communities, but the military seldom intercedes on their behalf. Even frantic cries for help on the radio fall on deaf ears. The most the Army will do is send a strike force to investigate and contain the enemy. If the D-bee village is lucky,

they will be under attack by hordes of demons or terrible monsters. Under this situation, the NGR military is likely to engage the enemy troops, not to save the village, but to push the enemy away from the borders of human habitation. The innocent are frequently beaten, punished and executed with the guilty.

Thankfully, small communities, especially farmers and fishermen, offer little resources that monsters want and are often ignored by them. Likewise, bandits usually look for richer targets. Still, the tiny villages are plagued by all sorts of dangers. Entities, werewolves and other supernatural predators may stalk the residents or make a hunting circuit or habitat within a 50 or 100 mile radius. Wild animals such as wolves or mountain lions may attack livestock, children or lone travelers. Mischievous faerie folk may cause trouble by playing pranks or stealing goodies or small objects. Criminals may seek temporary refuge in the community. Mercenaries or bandits may visit, loot and terrorize the community — the reign of terror may last a few short hours or days. Furthermore, a tiny village may get caught in a larger battle. Angry NGR soldiers and monstrous warriors bent on destruction or with a need to vent their anger, have been known to blast a village and its people into dust.

Surprisingly, a large percentage (at least 40%) understand why the NGR treats them so badly and they forgive them. These gentle sentients believe the circumstances of the terrible war has made the humans act out of desperation and fear. They have seen just as many non-humans do the same or worse, so they hold no grudge against humankind and simply pray for better days to come. These admirable beings will work with and fight for the NGR if given the opportunity.

The NGR's expulsion of D-bee citizens in around 45 P.A., its continuing campaign of human supremacy, and detestable treatment of D-bees, has caused tremendous animosity and bitterness among many non-humans in and around the NGR. This has driven some to a life of crime or to join forces with the enemy. Other D-bees are not active subversives, but despise humans and treat them with the same generosity as they have been shown. The NGR's cruel indifference and abandonment has made the majority of the non-humans, particularly the least human-looking, to view humans as just another enemy as loathsome as the gargoyles or brodkil. This sentiment has created hundreds of outlaw gangs who feel justified in plundering human travelers, merchant caravans, small villages, military supply lines, and troop encampments.

The boldest of these rogues will sneak into cities or onto military bases to steal whatever they can or to vandalize buildings and equipment. Some of these gang members are as evil as the monsters they hate, while others are mercenaries, thieves, scavengers and gypsies doing whatever is reasonable to insure their survival. However, that does not include working with the NGR, the Gargoyle Empire, Brodkil or demonic forces. **Note:** These D-bees are not necessarily selfish or evil, they simply see humans and NGR soldiers in particular, as the enemy.

True bandits on the other hand, are typically cutthroats, murderers and thieves of an evil or selfish alignment. Consequently, evil bandits, including humans, may affiliate with or work for the Gargoyle Empire, Brodkil, or other supernatural beings. It's interesting to note that gypsies seldom plunder these poor communities and frequently even come to their aid.

FIRST-TIMER

FIRST TIME
OUT, KID?

YES, ERR...YES SIR.
MY FIRST TIME
OUT.





WELL KID, YOU STICK WITH ME AND ETHEL AND YOU'LL BE JUST FINE.

WHO'S ETHEL?

ETHEL? SHE'S MY BEST GIRL AND SHE'S ONE TOUGH MOTHER IN A FIGHT!

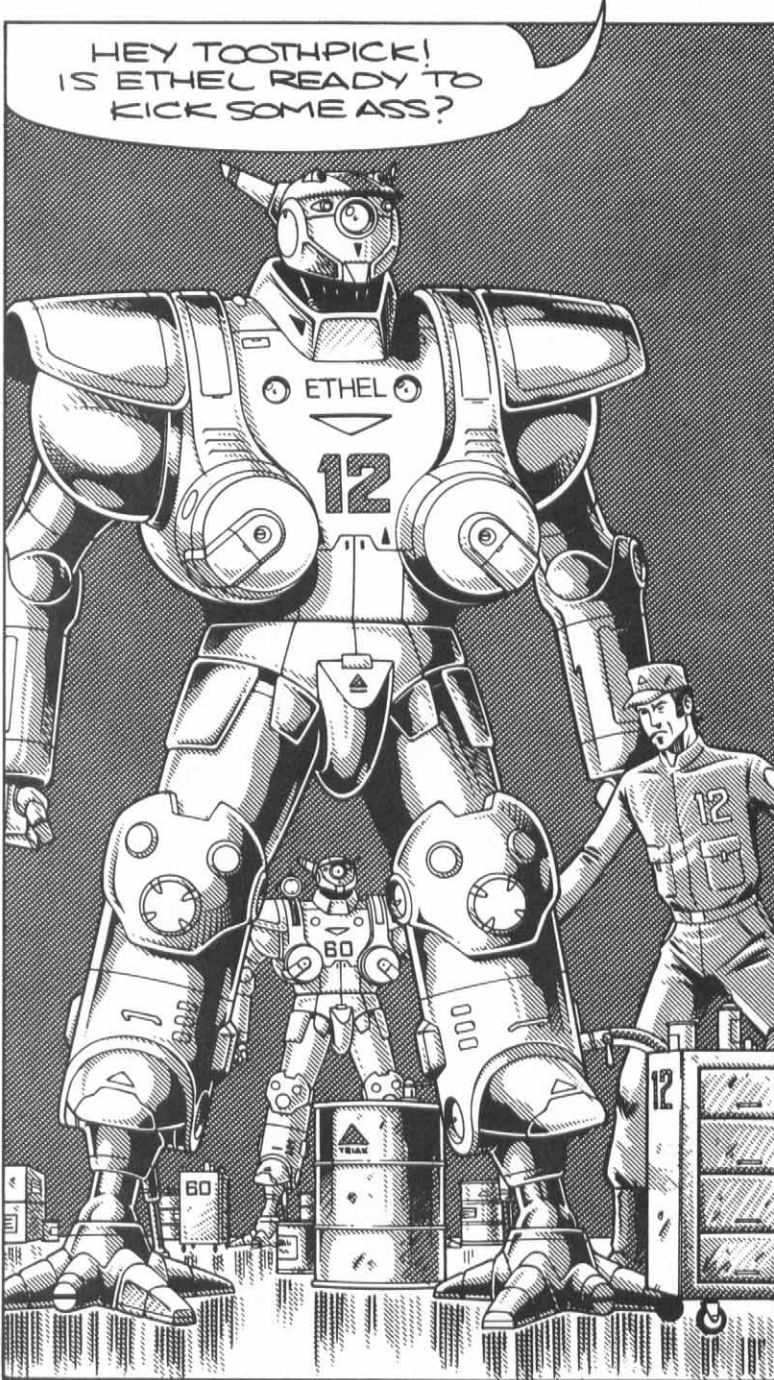

HEY TOOTHPICK! IS ETHEL READY TO KICK SOME ASS?



YEAH, SHE'S READY LIEUTENANT. WE REPAIRED THE DAMAGE FROM YOUR LAST OUTING AND ALSO UPGRADED HER MAIN GUN PER YOUR REQUEST!



GREAT! I'VE WANTED ONE OF THOSE NEW VARIABLE FREQUENCY LASERS FOR QUITE AWHILE NOW.



YEAH, YOU'RE GONNA NEED IT WITH "FIRST TIMER" HERE!

WINK!

2

SOMEWHERE OVER
THE BLACK FOREST IN
SOUTHERN GERMANY.

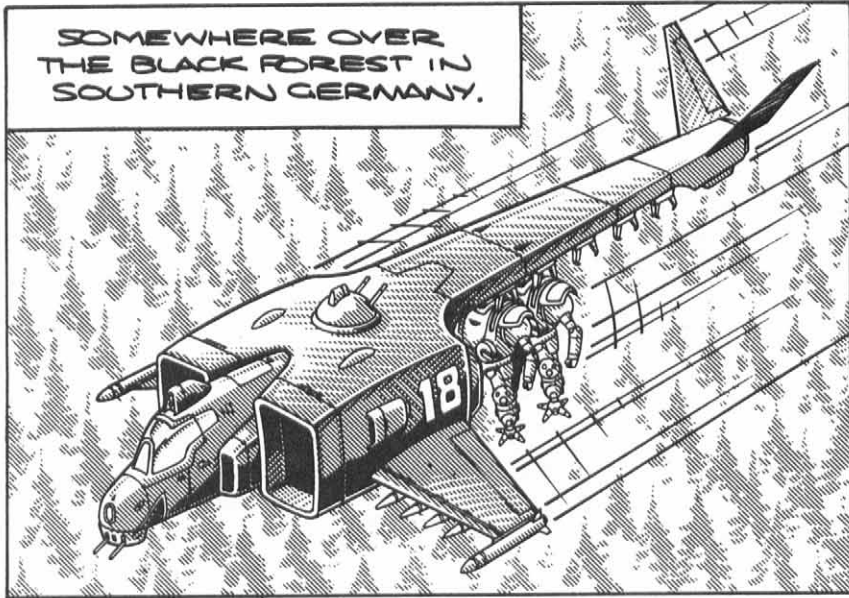

WE'RE NEARING
THE
DROP ZONE,
LIEUTENANT!



ROGER,
FLY-BOY!!

FIVE SECONDS TO
RELEASE...



5

4

3

2

1

DROP!

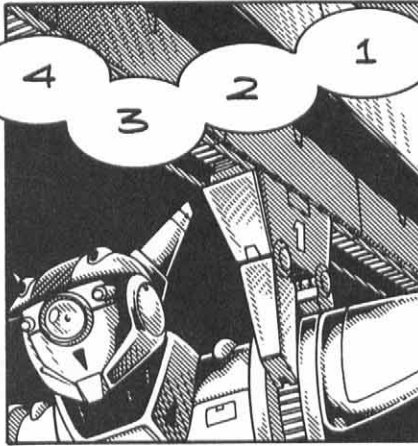

KTANG!

YEE-HAA!



GULP!

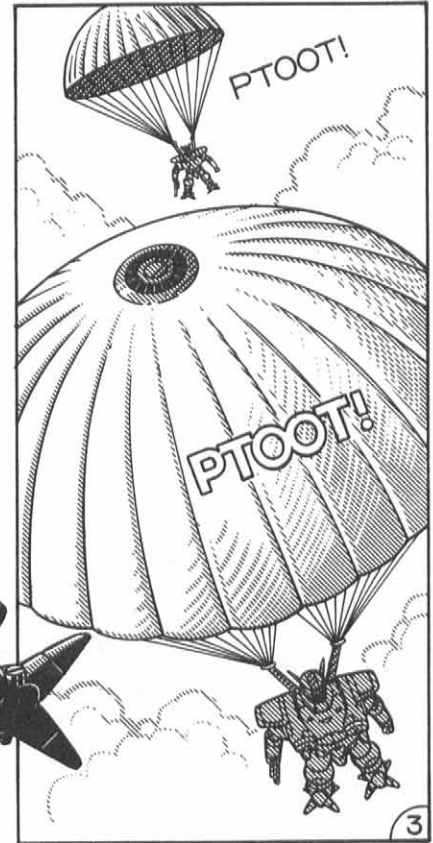

PTOOT!

PTOOT!

3

ON PATROL...



SIR... MY SENSORS ARE PICKING UP TWO READINGS FIVE KLIKS SOUTH OF OUR POSITION.

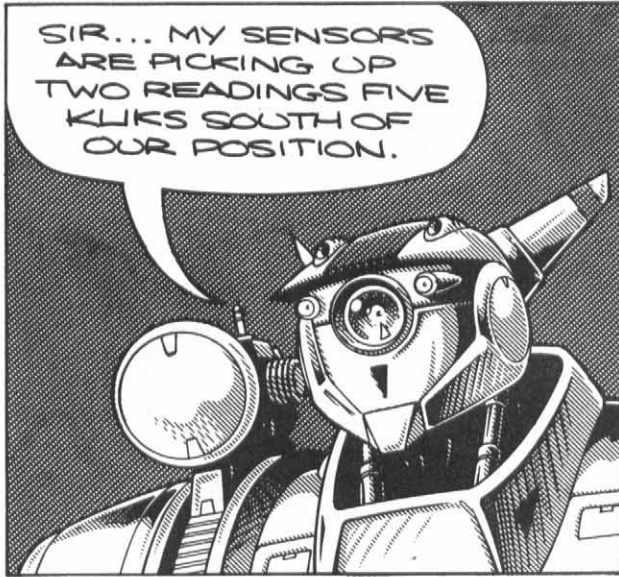

LOOKS LIKE WE GOT US SOME BOGEY'S, KID! LET'S GO!

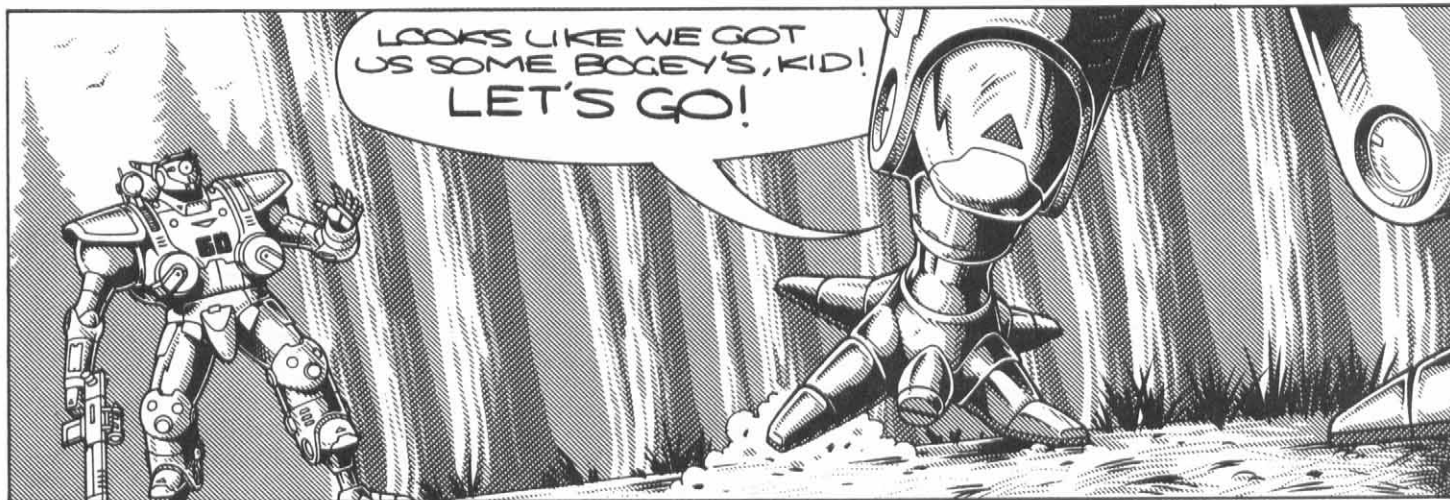

LATER...

ONE OF OUR BOGEY'S IS DIRECTLY AHEAD, SIR! THE OTHER IS ABOUT HALF A KLIK BEHIND THE FIRST!

I'M SWITCHING OVER TO INFRARED MODE, NOW!!



Δ INFRARED MODE

Δ 271118

Δ TARGET ACQUIRED

Δ 212881

Δ 116759

I'VE GOT AN INFRA-READING! COMPUTER IS UNABLE TO IDENTIFY OUR BOGEY'S SIGNATURE.

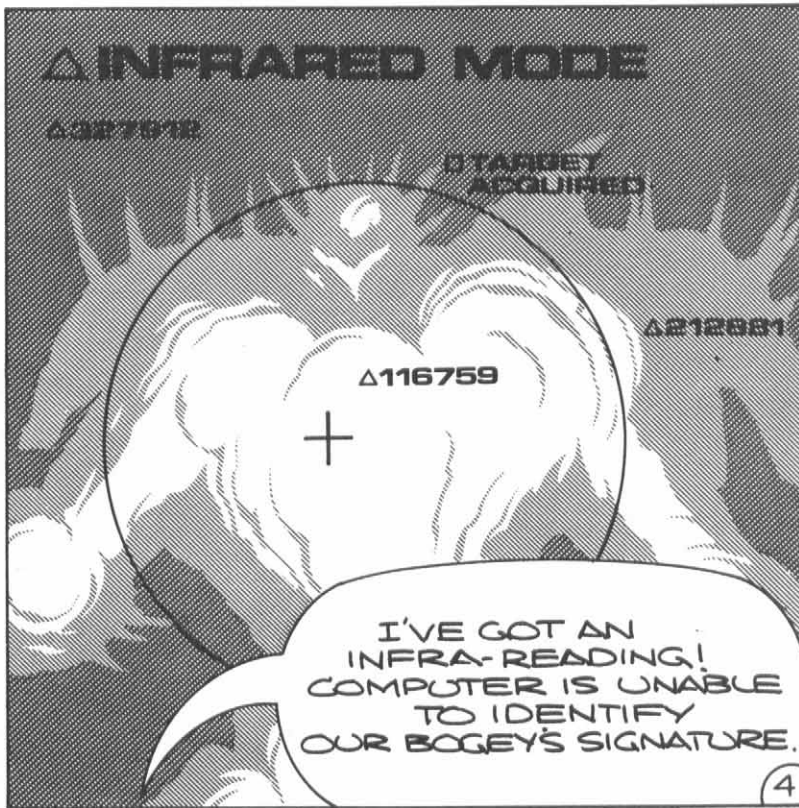

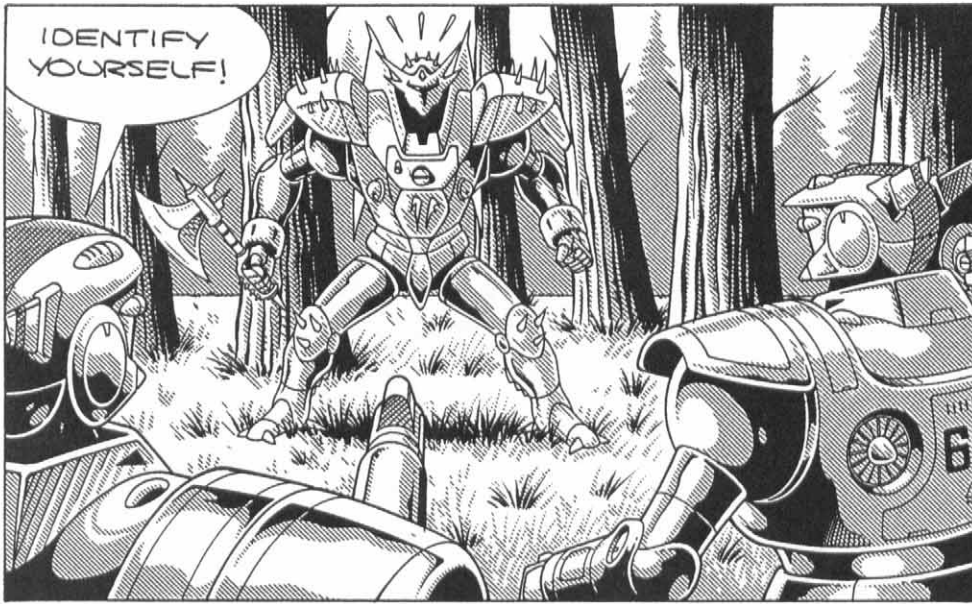

IDENTIFY YOURSELF!

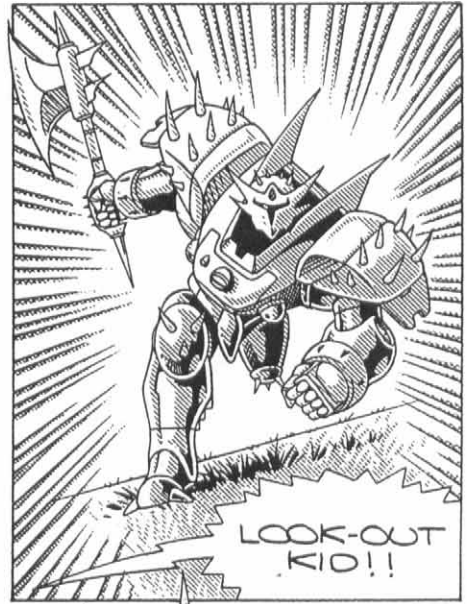

LOOK-OUT KID!!

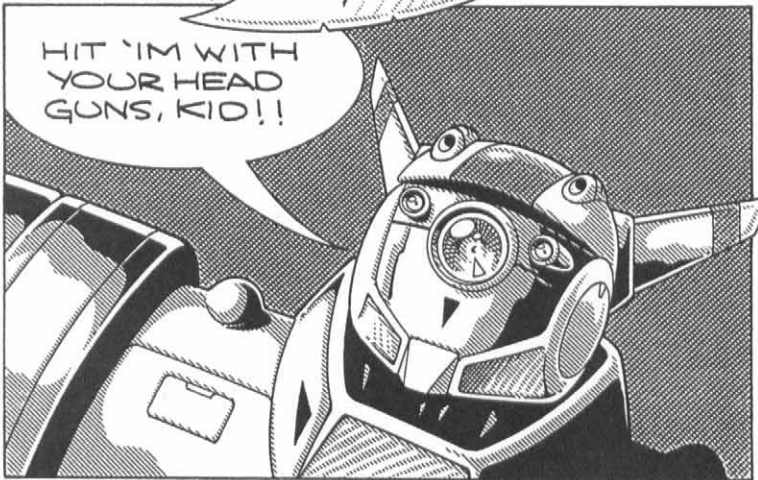
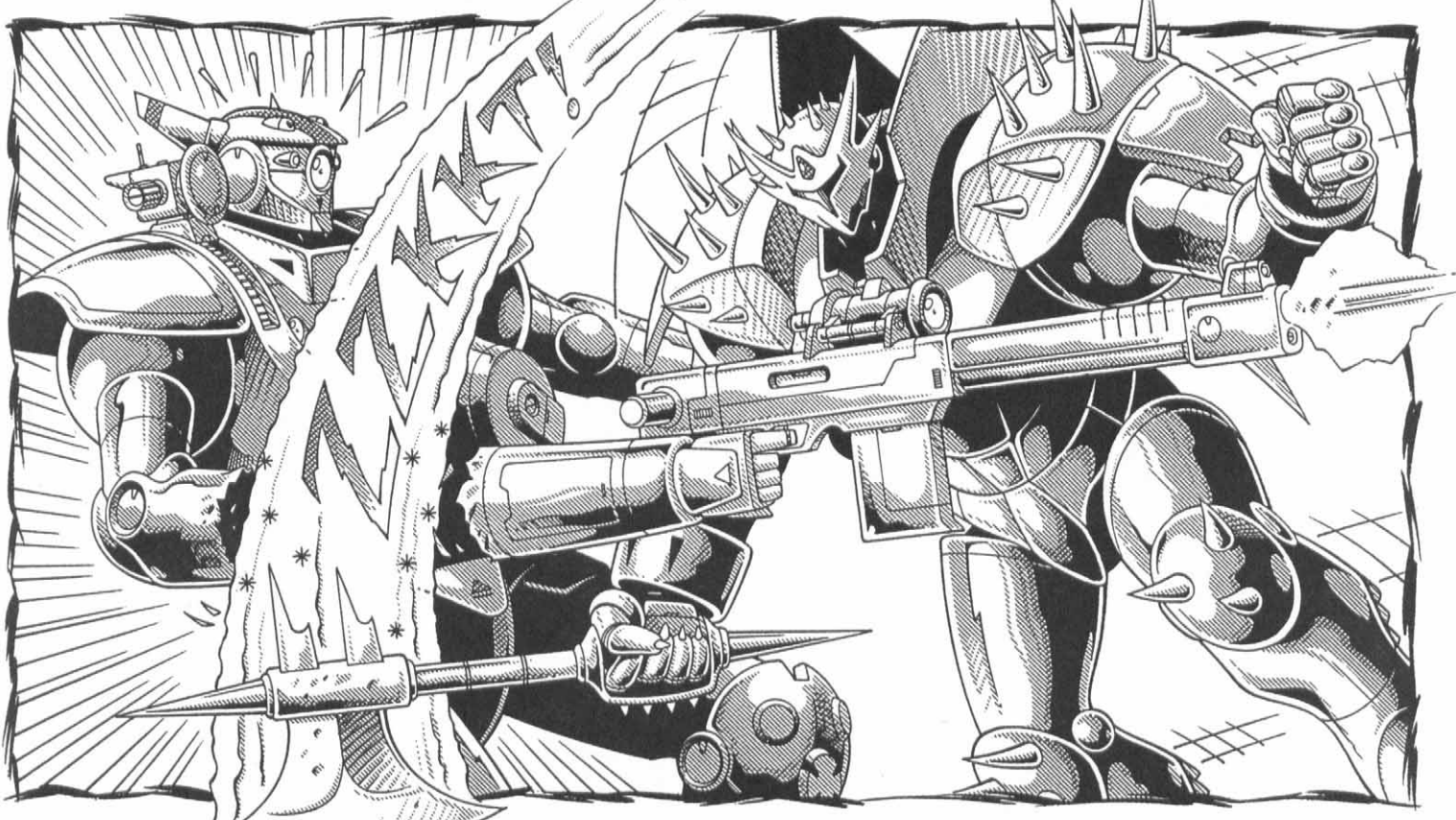

HIT 'IM WITH YOUR HEAD GUNS, KID!!

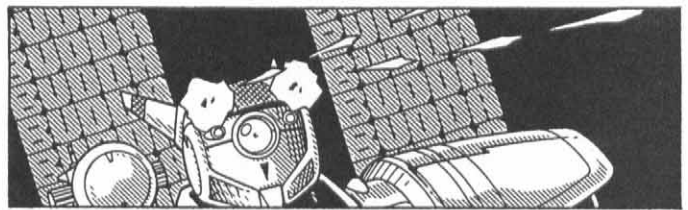

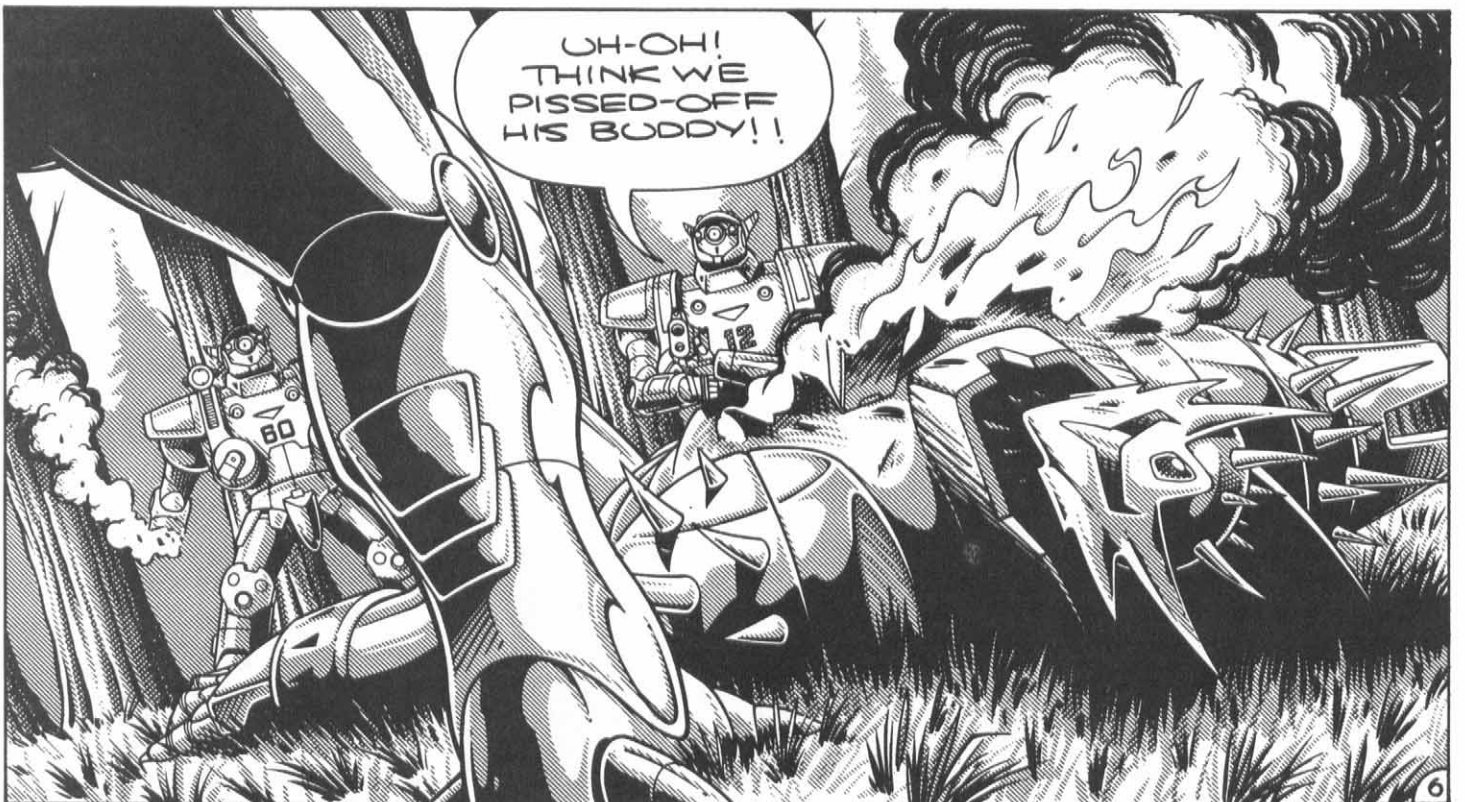
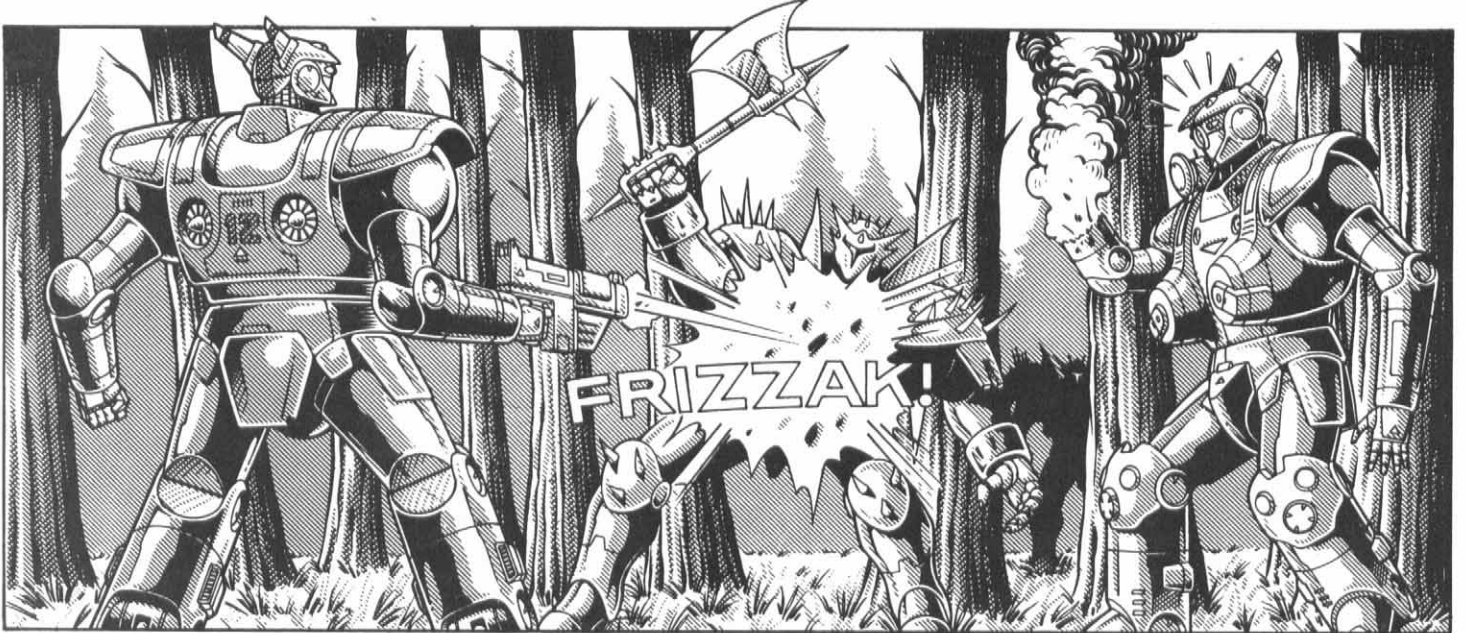
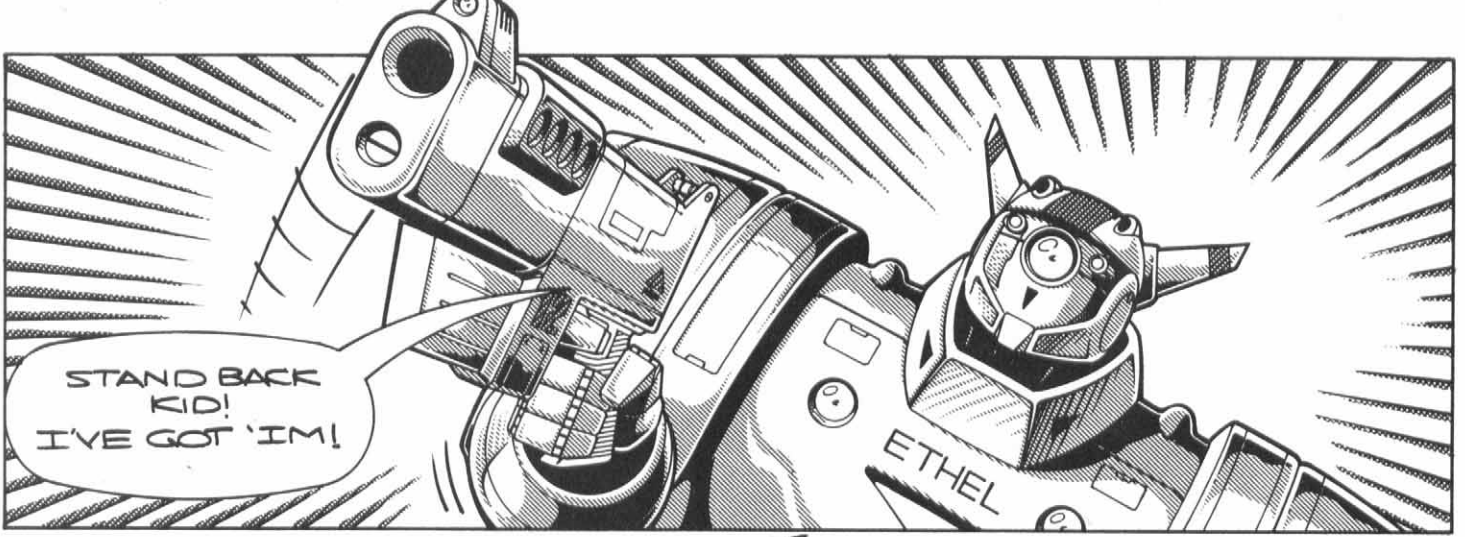

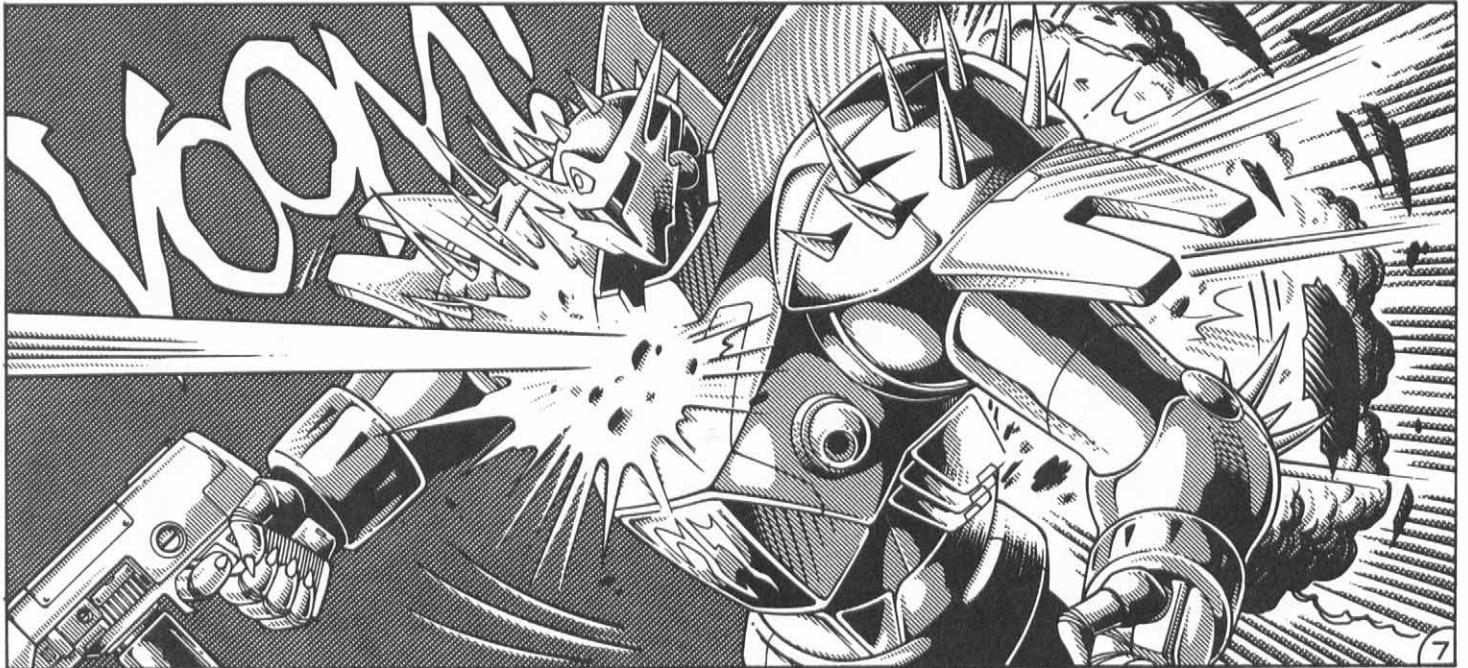
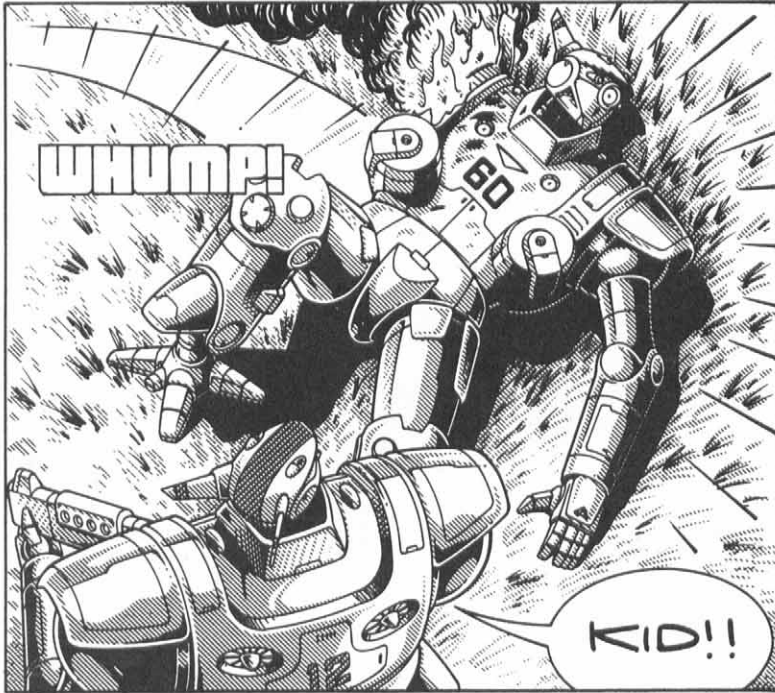
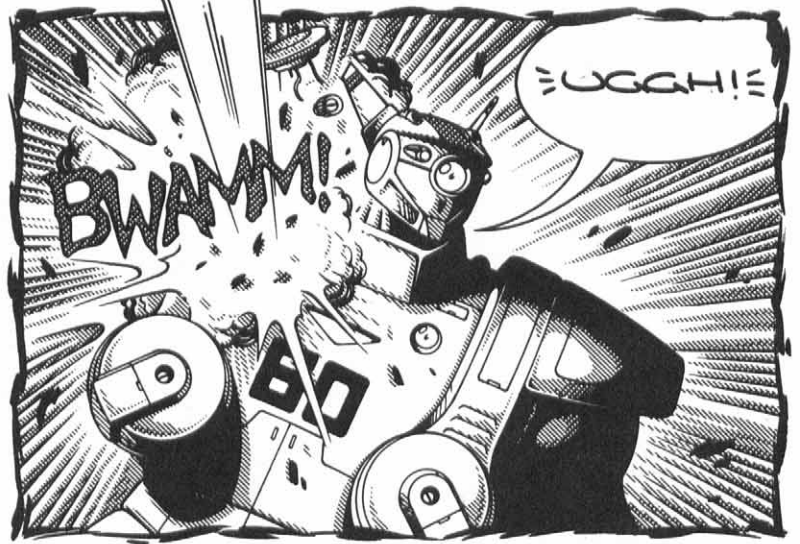
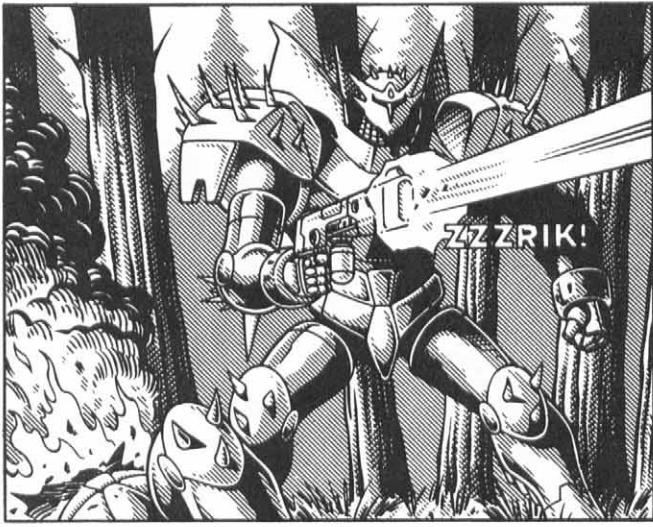

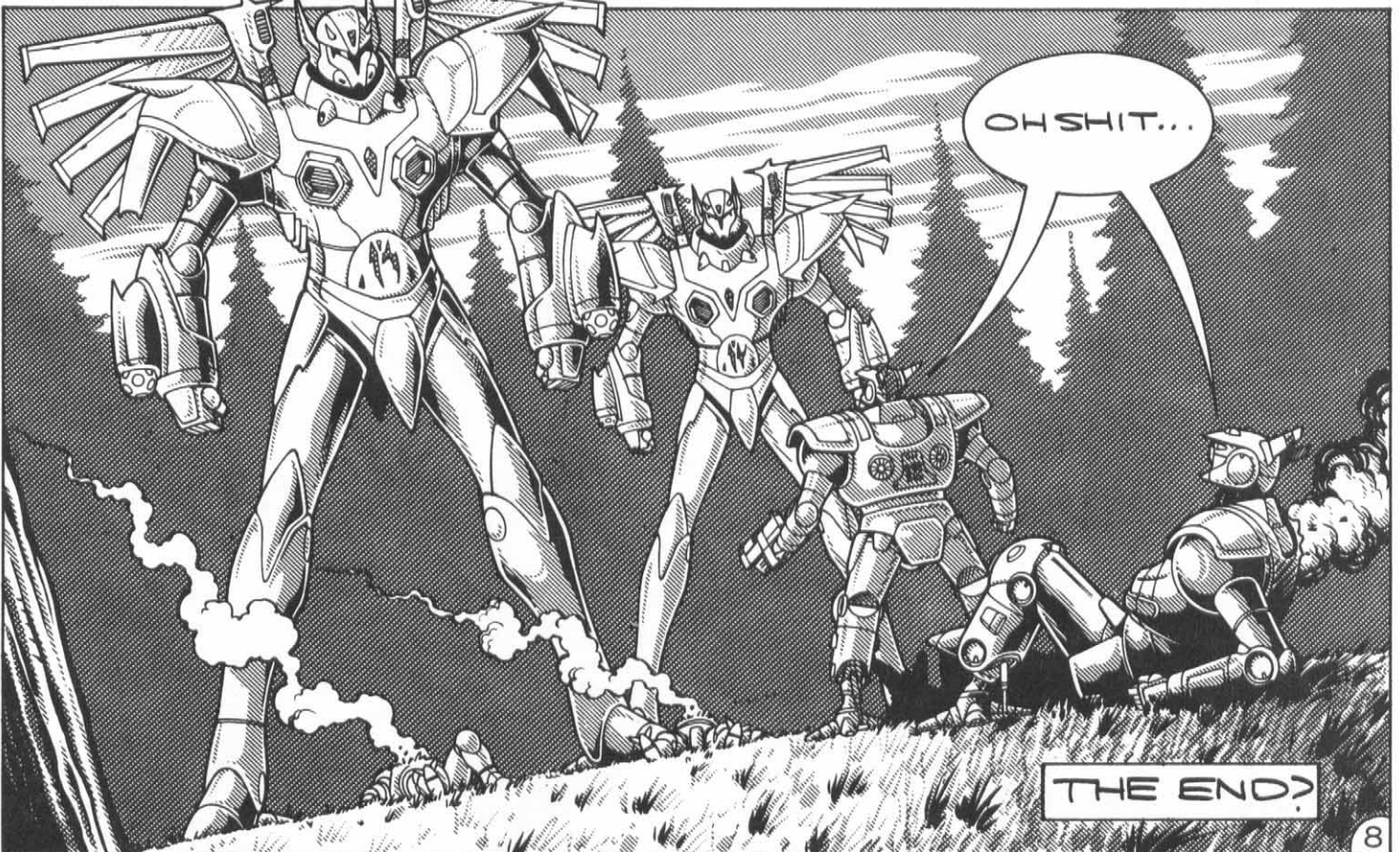
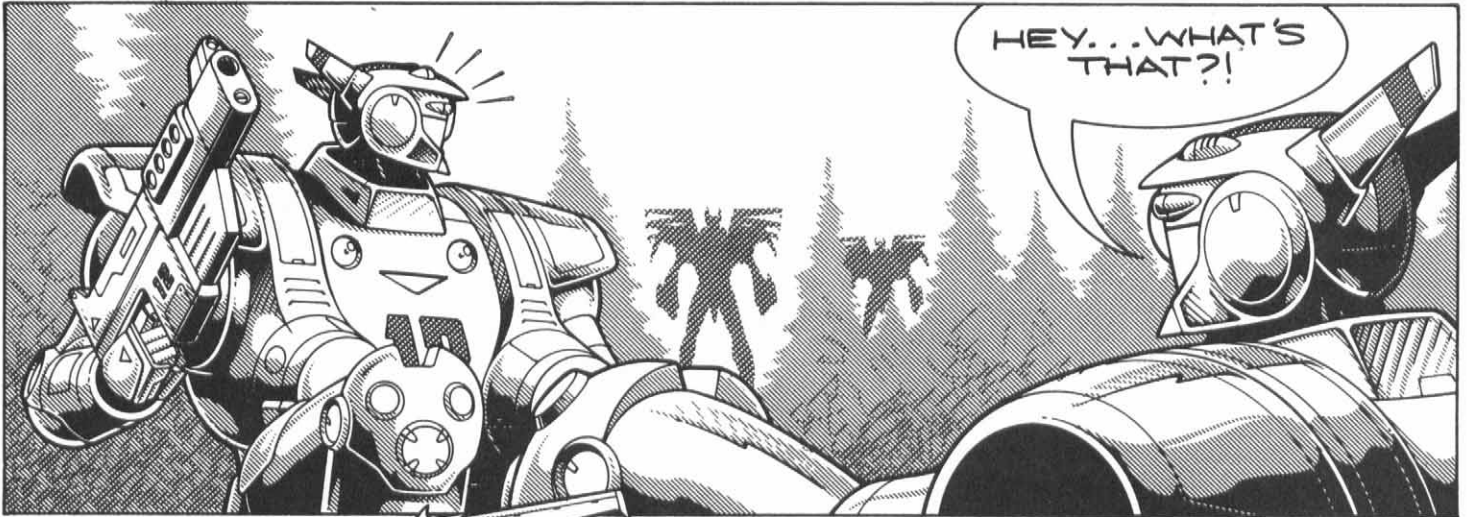

The Monster Zones

Beyond the Borders of the NGR

Beyond the borders of the New German Republic is the dominion of monsters. Areas known to be inhabited by large concentrations of monsters are designated as **Monster Zones**. Human and D-Bee communities located in the Monster Zones are left to the mercies of the god. The NGR seldom has any presence at these enemy strongholds and avoids them unless waging a major offensive to “clear” an area of hostiles.

“Clearing” an area of hostiles is just as likely to displace, injure and kill innocent D-bees as it is likely to eliminate enemy troops. However, since even humans living in these areas are looked upon with suspicion, D-bees are considered to be “The”

enemy, the military has little compassion for their plight. Whatever mercy is shown rests entirely on the shoulders of the military commander and the men assigned to the task. Some are abundantly merciful and try to avoid hurting women and children and provide at least enough protection to give the innocent population a chance to flee the area. Others shoot everything that moves and take great pleasure in ridding the world of one more “monster.”

The Monster Zones are frightening even when there are no apparent monsters within a hundred miles. These lands are plagued by the likes of gargoyles, gurgoyles, brodkil, gene-splicers, vampires and monsters and D-bees too numerous to list. A traveler never knows who or what he may encounter, or whether or not that encounter will lead to violence.

TriaxTM Armor, Bots & Borgs

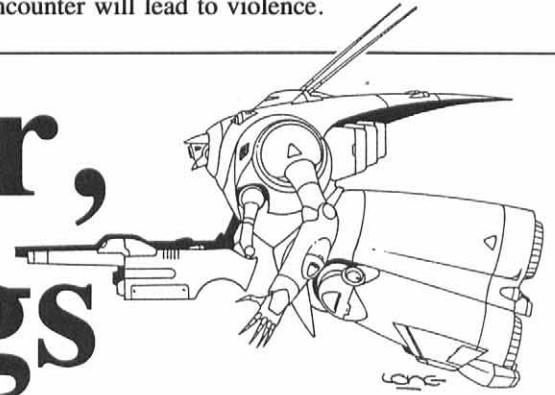

Concepts & Art by Kevin Long

Additional Art & Designs by Newton Ewell

Written & Developed by Kevin Siembieda

Triax Industries builds some of the most technologically advanced robots, cyborgs, power armor, body armor and weapons on Earth. What follows is a list and description of Triax creations currently in use by the NGR.

Triax Designation Letters

T — All body armor and man-size power armor.

TX — Most man-size, hand-held weapons, including pistols, rifles, and rail guns. The TX designation is also frequently applied to giant robot and power armor weapons.

X — This designation applies to all giant robots and some robot-like power armor suits larger than 10 feet (3 m) tall.

XM — Most military vehicles.

VX — All borgs and the occasional special power armor item such as the VX-180 and VX-160 Ulti-Max weapon systems.

DV — Most self-sufficient robots (no human pilot), such as the Dyna-bot.

T-Series Body Armor

T-10 Standard NGR Military Body Armor (“Cyclops”)

T-11 Enhanced

T-12 Field Medic Armor

T-13 Field Mechanic Armor

T-40 Urban “Plain Clothes” Armor

T-41 Riot Suit

T-42 Commando Scout

T-43 Explorer

Non-Triax Suits (like the G-10 soldier) are also available.

T-Series Power Armor

T-21 Terrain Hopper

T-C20 Terrain Hopper

T-31 Super Trooper

T-550 Glitter Boy (new)

X-Series Power Armor & Robot Vehicles

X-10 Predator (mass market power armor)

X-10A Predator (NGR combat version power armor)

X-60 Flanker (power armor)

X-500 Forager

X-535 Jager/Hunter

X-545 Jager-Armored

X-622 Bug

X-821 Landcrab

X-1000 Ulti-Max (power armor)

X-2000 Dyna-Max

X-2700 Dragonwing

X-2500 Black Knight

X-5000 Devastator

Robot Drones

DV-12 Dyna-bot

DV-15 Sentry Bot

DV-40 Hunter/Killer Drone

EIR-10 Gargoyle Drone

EIR-15 Gargoyle (manned)

EIR-20 Gurgoyles Drone

EIR-30 Gargoylite

EIR-50 Gurgoyles Android

Cyborgs

EIC-100 Gargoyle Borg

VX-300 Striker (human-size)

VX-320 Cyclops (human-size)

VX-340 Slasher/Gold Type

VX-370 Stopper/Blue Type

VX-500 Manhunter/Red Type

VX-635 Prowler (human-size)

VX-2010 Marauder

VX-2020 Monster

Triax Body Armor

Triax and other manufacturers make a variety of different types and styles of body armor, including those found on pages 209 to 211 of the **Rifts RPG**. However, the armor used by New German Republic soldiers is made exclusively by Triax for the military and *never* sold to mercenaries, adventurers or other kingdoms.

NGR "Cyclops" Body Armor

The military body armor is a combination of lightweight, mega-damage fabric, ceramic, metal and plastic plates and padding, all bonded on a molecular level, making it stronger than steel. Each suit of mega-damage armor is a self-contained unit, making it a complete environmental system like a spacesuit. Air filters, circulation, cooling, and an independent oxygen supply (which engages as needed) prevents toxic fumes, gases, smoke and irritants from affecting the soldier inside; unless the armor is breached. All of the NGR military body armors have the same basic design although some of the features and levels of protection may vary.

Cyclops Helmet & Sensors

One of the armor's most unique features is the helmet. It has no visor or slot from which the wearer can look out. Instead, it has a voice activated sensor response system. Video images, graphs, charts, and data are displayed on a split Heads-Up Display (HUD). The round nozzles on the top of the helmet and the large cyclops-like lens in the center are all part of the optics and sensor system.

The following capabilities can be accessed via the cyclops helmet:

1. **Normal Optics and Split View Screen/Projection:** A video projection simulates normal color vision. Video images are displayed on the HUD. The HUD is aligned perfectly with the eyes and the images are so crisp and clear that the wearer will find it difficult to tell the difference between the projected image and his own sight. When additional data, charts or transmissions are called up, the HUD image can split into two or three different viewing sections. For example: The largest image simulates human vision and what the character sees in front of his face. A second area shows a radar screen and tracks the movement of several blips moving rapidly closer (radar is available via a headjack-link). A third screen can show a map, mathematical computations, or printed data about any number of things.
2. **Computer & Video Link:** The helmet can be patched into computers, televisions, cameras, monitors and sensory equipment. This means video transmissions and encoded audio-video signals can be displayed directly on the HUD. This requires "plugging in." Located in the ear section of the helmet is a universal headjack. The jack is cordless and has a maximum transmission/receiving range of 20 feet (6 m).
3. **Standard Optical Enhancements:** Passive nightvision (2000 foot/610 m range), telescopic (5× magnification, 6000 foot/1830 m range), and light filters.

4. **A miniature multi-purpose computer** that will indicate system errors within the armor, damage levels, and oxygen supply, and that also functions as a calculator and clock indicating time (can be used a stop watch and alarm clock too), date, and direction (compass).
5. **Laser distancer:** Indicates distance of a target or item. Effective range: 1000 feet (305 m). Maximum range: 2000 feet (610 m)
6. **Laser Targeting:** Adds a +1 strike bonus. Effective range: 1000 feet (305 m). Maximum range: 2000 feet (610 m)

All NGR "Cyclops" military body armor (and most types of environmental suit) have the following properties:

- A minimum of 70 M.D.C.
- Complete environmental battle armor suitable for use in all hostile environments, including underwater and outer space.
- Computer controlled life support system.
- Internal cooling and temperature control.
- Artificial air circulation systems, gas filtration, and humidifier.
- Computer controlled, independent oxygen supply and purge system that automatically engages in low oxygen or contaminated air environments. Five hour oxygen supply.
- Insulated, high temperature resistant shielding for up to 300 degrees centigrade. Normal fires do no damage. Nuclear, plasma, and magic fires do full damage.
- Radiation shielded.
- Built-in loudspeaker; 80 decibels.
- Directional, short range radio built into the helmet. Range is 5 miles (8 km).
- The armor is also designed for quick and easy attachment of a jet pack, or other backpacks, directly to the suit.
- Ammo and supply waist belt. Officers get a shoulder belt, holster and sidearm. Grenades and additional pouches can be attached to both the waist and shoulder belts.
- Suit-up time: A trained soldier or mercenary can suit-up in environmental armor in one minute! The untrained will take 1D4+1 minutes.

Note: Standard issue of weapons to the infantry is the TX-42 variable frequency, pulse laser rifle. The TX-50 rail gun, TX-16 pump rifle, TX-30 ion rifle, or TX-11 sniper laser rifle and explosives may also be made available depending on the soldier's O.C.C./M.O.S. and the assignment. Energy pistols are typically reserved as sidearms for officers.

T-100 Eagle Jet Pack accessory for NGR body armor

The T-100 Eagle is the jet pack designed for military use by Triax and it fits all NGR military armor and the new T-42 Commando Scout armor. The T-100 Eagle has an improved propulsion system and super-cooling system that makes it faster and gives it more flight time than its older mainstream cousin, the Falcon 300. However, the Falcon 300 or the Wilk's jet pack can be substituted in a pinch.

- Maximum Speed: 200 mph (321.8 km)
- Maximum Range: Effectively unlimited, but 600 miles (1000 km) when considering the cooling and maintenance of the jet pack. The range is effectively unlimited, but the jet pack begins to overheat if used continuously for more than three hours. Overheating will burn out the internal systems, de-

stroying the jet pack. The T-100 should be allowed to cool for 20 minutes after every three hours of continuous flight/use. Pushing the system for four hours of use creates a 1-40% chance of overheating and burnout.

- Weight: 35 lbs (15.75 kg)
- Length: 3 ft (0.9 m)
- Weapons: None
- M.D.C.: 30
- Engine Type: Nuclear, with a 10 year life.
- Market Cost: 600,000 credits
- Available upon assignment.
- Colors: Light grey or camouflage.

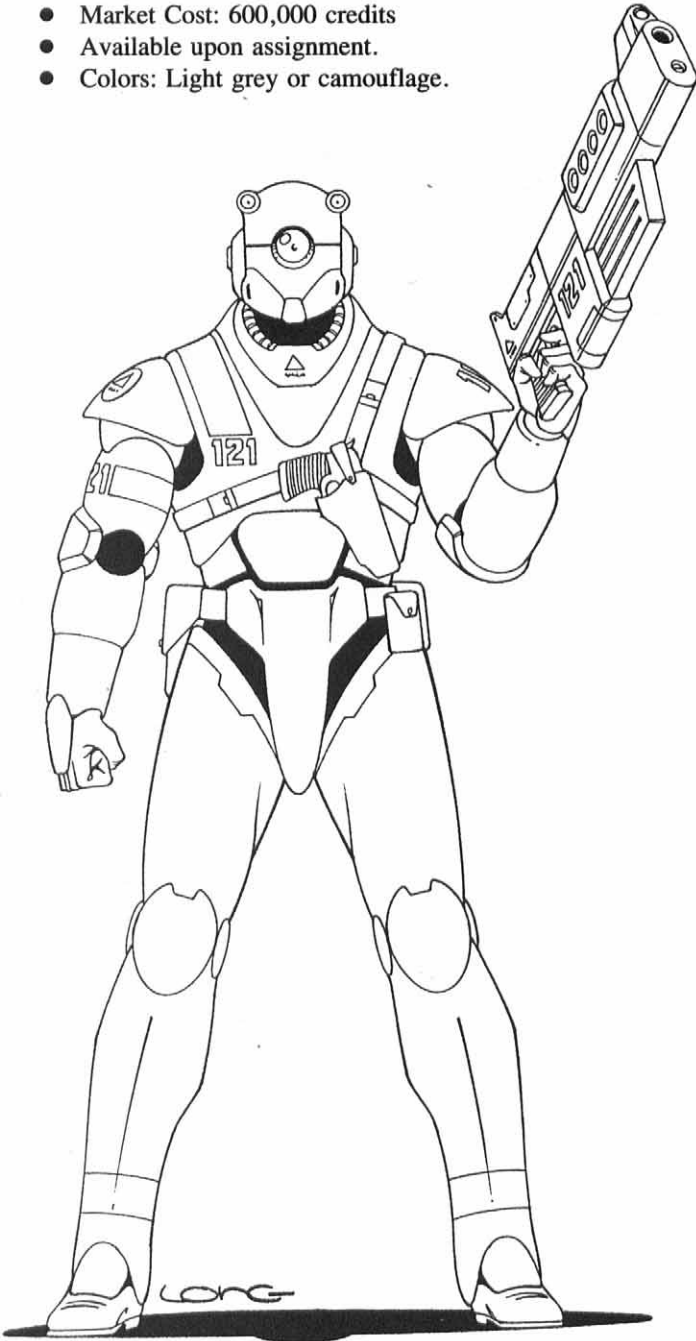

T-10 Infantry "Cyclops" Body Armor

Exclusive to the NGR Military

Worn by the infantry. This suit can be used by any of the NGR Military O.C.C.s as needed or desired. The T-10 affords the maximum amount of mega-damage protection.

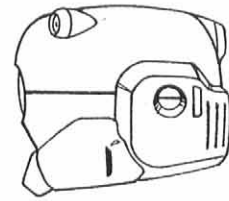
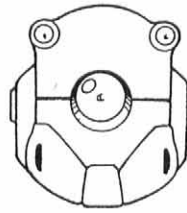

- M.D.C.: 100
- Weight: 25 lbs (11.34 kg)
- Fair mobility, -15% prwl penalty.
- Black market cost: 60,000 credits; poor availability.
- Colors: Light grey or camouflage. Officer armor is a darker shade of grey (or camouflage for special assignments).

T-11 Enhanced Body Armor

Exclusive to the NGR Military

The T-11 looks like a bulkier version of the T-10 body armor. The only difference is that the T-11 Enhanced armor is supplemented by a robot exo-skeleton built into the armor. The exo-skeleton is less powerful than power armor, but does add to the brute strength and speed of the soldier wearing it. It also reduces fatigue and mobility penalties.

The T-11 Enhanced body armor can be assigned to any of the NGR Military O.C.C.s. It is typically assigned to soldiers who have an impressive natural strength or speed, platoon sergeants, rail gunners, special operatives, and those assigned to heavy weapons/equipment, and construction.

- M.D.C.: 100
- Weight: 40 lbs (18 kg)
- Good mobility, -5% prwl penalty.
- The exo-skeleton adds the following bonuses to the attributes of the soldier as long as he's wearing the enhanced armor: +6 to P.S., +10 to spd, +10 feet (3 m) to leaps, +10% to climb skill, and reduce the rate of fatigue by 50%.
- Penalty: Takes two times longer to suit up.
- Black market cost: 100,000 credits; poor availability.
- Colors: Light grey or camouflage. Officer armor is a darker shade of grey (or camouflage).

T-12 Field Medic

Exclusive to the NGR Military

This armor is worn by the field medics and doctors. It is lighter in weight to allow greater mobility. It also comes equipped with a **medical harness** made of many large pouches to carry medical supplies. Two smoke grenades and a signal flare are also standard. Additional belts with smaller pouches are often attached to the legs. A medical and surgical kit are attached to the waist belt. Additional medical equipment is carried in a backpack and/or in hand-held carrying cases or sacks.

The **medical cyclops helmet** has a pair of directional lights located on the sides of the helmet about halfway down the head. The lights can be angled 45 degrees in all directions and have a range of six feet/1.8 m. The helmet also has the additional optical enhancements of a macro lens with 10× magnification and thermo-imaging; both have a range of four feet (1.2 m).

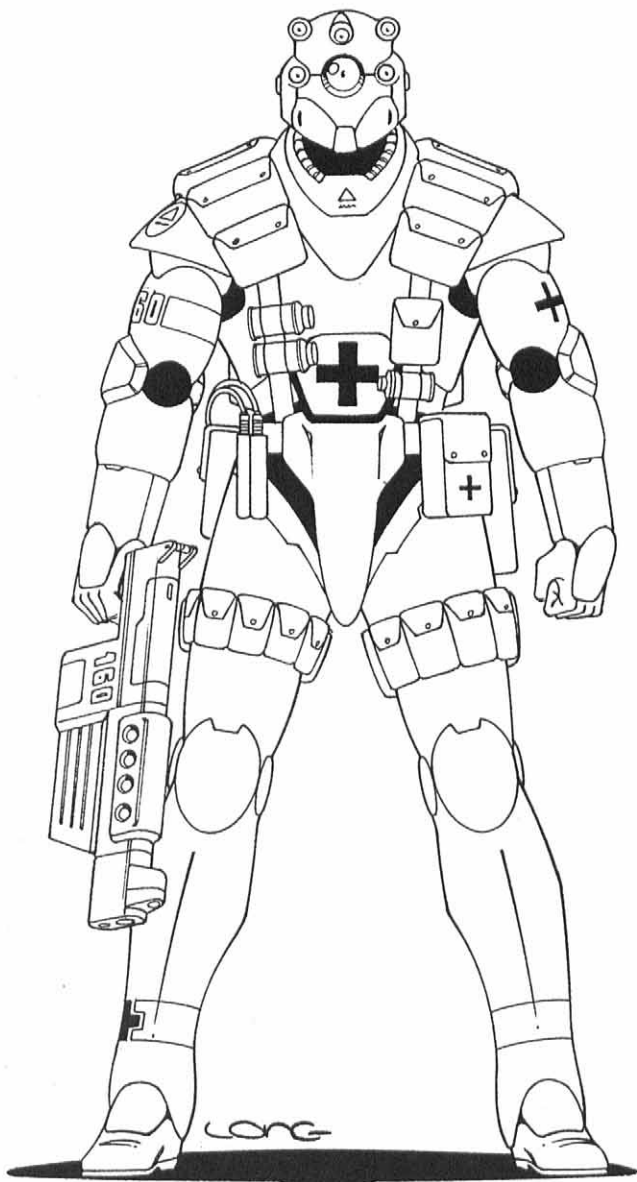

- M.D.C.: 70
- Weight: 17 lbs (7.7 kg)
- Good mobility, -5% proul penalty.
- Black market cost: 65,000 credits; poor availability.
- Colors: White or light grey with a red cross symbol on the belly, left arm, ankles, back and/or backpack.

Note: A light grey, black and camouflage version of this light armor, without the medical symbols and equipment, but including all the features of the medical "cyclops" helmet, is available to military specialists for espionage and intelligence missions.

T-13 Field Mechanic

Exclusive to the NGR Military

The T-13 armor is worn by field mechanics. Like the medic's suit, it is lighter in weight for greater mobility. It also comes equipped with a sidearm shoulder holster and belts. Additional equipment pouches can be attached to the holster belts and/or smaller pouches can be attached to the legs. A portable tool kit is attached to the waist belt, while larger equipment and tool kits are transported in a backpack and/or carrying cases by hand.

A **laser torch** is built into the right or left arm depending on the mechanic's preference. It is primarily used for soldering and cutting metal. The torch can be calibrated to inflict as little as 1D6 M.D. to 6D6 M.D. or any increment of 1D6 in between. However, the range is limited to 100 feet (30.5 m). The basic energy clip provides enough power for 20 1D6 blasts or two 6D6 M.D. blasts. The number of laser blasts can be increased by 10 times when connected to an optional *energy pack*. The energy pack can be worn on the hip or carried on the back. The laser beam can be made narrower to increase its range to 1000 feet (305 m) when used as a weapon, but inflicts a maximum damage of 3D6 M.D.

An **extendable robot arm with a laser finger** is located on the arm opposite the laser. It is used to access small areas and places out of normal reach. The arm is fully articulated and can pick up objects, use basic tools, turn knobs, press buttons, and so on. The arm is very lightweight (one pound/0.45 kg), adds 3 feet (0.9 m) to the mechanic's reach, has a P.S. of 9 and can lift as much as 90 pounds (40.8 kg). The **laser finger** has a range of two feet (0.6 m) and damage is limited to 1D6 S.D.C. to 2D6 × 10 S.D.C., or one mega-damage point.

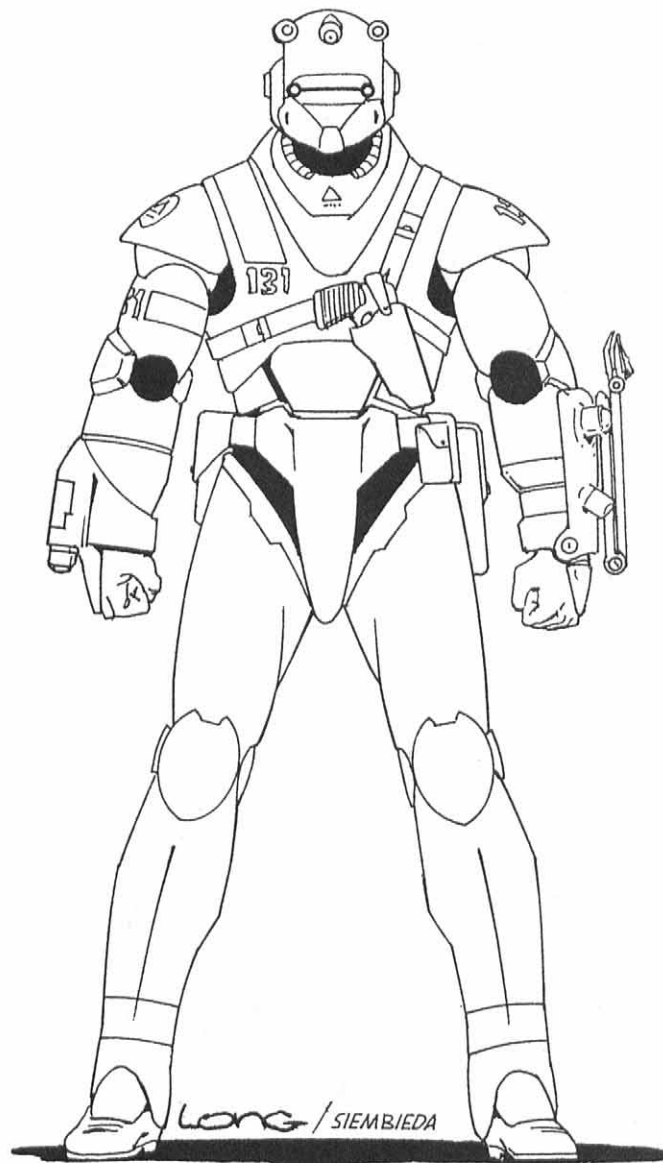

The **mechanic's cyclops helmet** has the addition of a pair of directional lights located on the sides of the helmet. The lights can be angled 45 degrees in all directions and have a range of six feet/1.8 m. It also has the additional optical enhancements of a macro lens with 2× to 10× magnification, infrared sight, thermo-imaging and a spectrographic scanner (used to locate damage, microscopic cracks and weakness in metal); all have a range of four feet (1.2 m).

- M.D.C.: 80
- Weight: 18 lbs (8.2 kg)
- Good mobility, -6% prowl penalty.
- Black market cost: 75,000 credits; poor availability.
- Colors: Light grey or camouflage. Officers wear a dark grey or a darker camouflage.

T-40 Urban "Plain Clothes" Armor

Military & Mass Market Body Armor

German Name: das Panzer Kleidung

A truly unique breakthrough in body armor technology has been Triax's development of a mega-damage fiber that can be made into ordinary suits of clothing! This is ideal for government officials, ambassadors, businessmen and adventurers who seek mega-damage protection in ordinary walks of life. The most popular versions of the inconspicuous "plain clothes" armor is the businessman's suit, jump suit, trench coat and outdoorsman's pants and jacket. However, jackets and vests are also available.

The more area of the body that's covered, the greater the protection. All types utilize mega-damage polycarbonate fiber, thin, concealed, lightweight plates (strategically located) and padding. All "plain clothes" armor are fireproof, impervious to damage from ordinary weapons, washable and hypoallergenic.

The "plain clothes" armor provides some degree of mega-damage protection in ordinary social situations, but they are far from the best armor available. They are not advised for use in combat situations.

Armor Rating (A.R.): The "plain clothes" armor does not protect the entire body, so it is given an *armor rating (A.R.)*. The higher the A.R. the better.

During combat an opponent's strikes are likely to hit the armor. The damage from all rolls that match or fall below the A.R. number is subtracted from the armor. Any roll above the armor rating will *penetrate* the armor and hit the character's body. Mega-damage weapons will kill most humans instantly or destroy a limb and send that character into shock. When all the M.D.C. of the armor has been depleted, the attacks will strike the character's vulnerable, human body. For example: A suit providing an A.R. of 19 will absorb all damage from attackers whose strike rolls are 19 or lower. A natural 20, or a 20, 21 or higher when strike bonuses are included, will hit a part of the body not protected/covered by the armor, such as the head (an automatic kill if a human or a non-mega-damage creature), hands or feet. When all the M.D.C. of the armor has been depleted, the cloth armor is shredded and future strikes will hit the character's unprotected body (time to find cover).

If the garment has an A.R. 20, it is superior protection, covering the entire body or 96% of it, including the feet, hands,

and the top of the head. To penetrate this armor the attacker must have a roll, with possible bonuses, of over 20.

Note: Striking a small moving target like the head, hands, and feet requires the attacker to make a "called shot" and even then the attacker is -4 to strike. Aiming for an arm, the character is -3 to strike, and -2 to strike a leg. To strike a tiny unprotected area of an otherwise covered head/face (armor with an A.R. 20), the attacker is -8 to strike.

Available Types of "Plain Clothes" Armor

The high cost is indicative of the special concealed features, style, craftsmanship and the cost of the special manufacturing process.

Standard Businessman Suit or Tuxedo: A.R. 19, M.D.C. 12, and weighs 12 pounds (5.9 kg). Excellent mobility: -2% prowl penalty. Cost: 50,000 credits.

Ultra-Businessman Suit or Tuxedo with Hat, Gloves and Boots: A.R. 20, M.D.C. 20, and weighs 20 pounds (9 kg). Good mobility: -5% prowl penalty. Cost: 75,000 to 100,000 credits depending on the style and quality.

Jump-suit with Hood: A.R. 19 with hood down, 20 with hood up. M.D.C. 12, and weighs 12 pounds (5.9 kg). Excellent mobility: -2% prowl penalty. Cost: 50,000 credits.

Outdoorsman's Pants & Jacket: A.R. 19, M.D.C. 15, and weighs 15 pounds (6.8 kg). An upturned collar helps protect the face. Good mobility: -5% prowl penalty. Cost: 45,000 credits.

Long Coat/Trench Coat Style: A.R. 18 (covers the arms, chest, waist, and upper legs), M.D.C. 15, and weighs 15 pounds (6.8 kg). An upturned collar helps protect the face. Good mobility: -5% prowl penalty. Cost: 50,000 credits.

Standard Jacket: A.R. 12 (covers the arms, chest and waist), M.D.C. 10, and weighs 10 pounds (4.5 kg). Excellent mobility: No prowl penalty. Cost: 25,000 credits.

Standard Vest: A.R. 10 (covers the chest and waist only), M.D.C. 10, and weighs 10 pounds (4.5 kg). Excellent mobility: No prowl penalty. Cost: 20,000 credits.

Note: A variety of colors, including camouflage, are available for all "plain clothes" armor, except tuxedos and business suits.

T-41 Riot Suit

Mass Market Full Composite Body Armor

German Name: der Aufstandanzug

The riot suit is used by corporate security forces other than Triax (Triax uses the T-10 to T-13 armor in blue colors with grey or gold trim and highlights). The T-41 Riot suit is a complete environmental body armor with all of the same features as the NGR armor other than the "cyclops" sensors and optics. They also have less M.D.C. for greater mobility.

The basic riot suit comes with a large, rectangular, impact resistant shield. The top portion of the shield is clear so the shield user can see through it. The shield is used as a means of additional protection, especially from thrown rocks, bottles and S.D.C. weapons. The user will typically squat or kneel behind it when debris or weapons are fired at him, harmlessly bouncing off the shield. It is light enough to carry with one hand, but bulky enough to make it a bit unwieldy to swing around (-1 to parry).

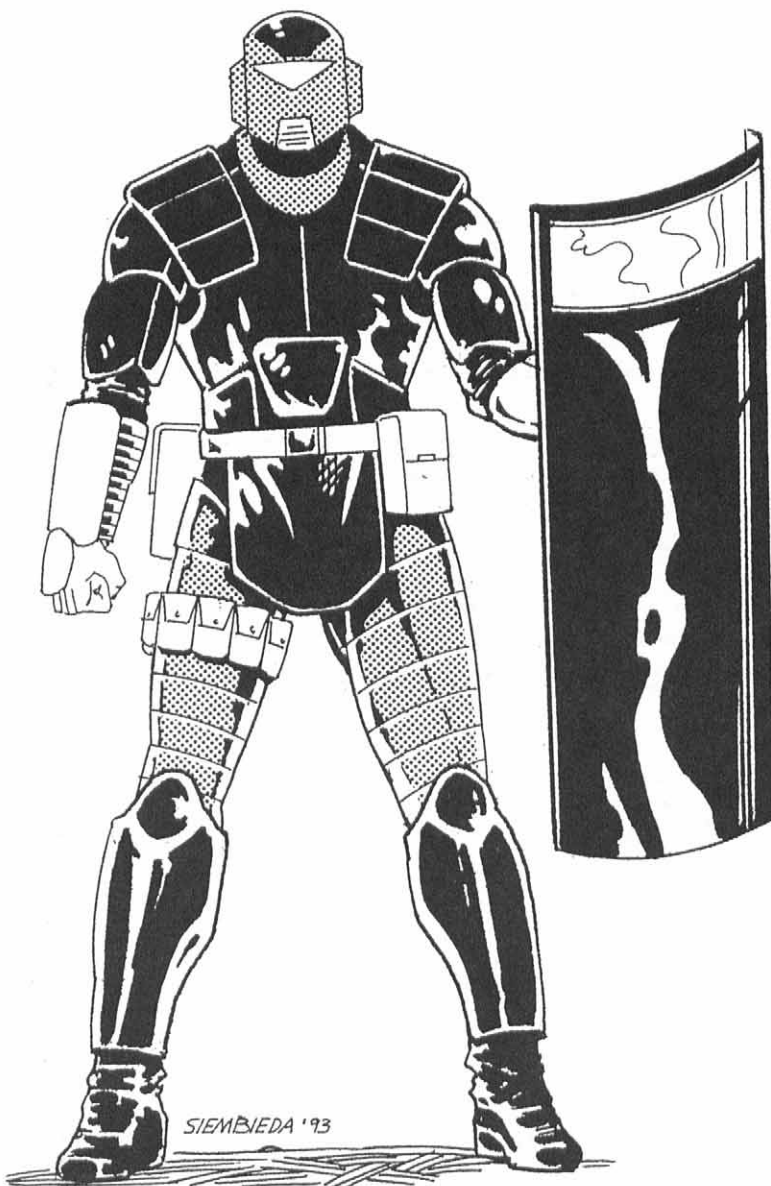

- M.D.C. 50 for the T-41 riot suit.
- M.D.C. 23 for the impact resistant shield (6 lbs/2.7 kg weight).
- Weight of the armor: 13 lbs (5.8 kg)
- Excellent mobility! No prowl penalty.
- Market cost: 25,000 credits; good availability.
- Colors: Black, white, dark brown or tan only.

T-42 Commando Scout

Mass Market Full Composite Body Armor

German Name: der Kommandotruppekundschafter

The T-42 is Triax Industries' latest innovation in body armor. It departs from what has become the traditional styling of the NGR military armor and incorporates a revolutionary, new, hybrid, super lightweight armor that offers maximum mega-damage protection without sacrificing mobility.

The T-42 helmet provides a mainstream version of the HUD optical system featured in the "cyclops" military helmet. The optics, laser and sensors are built into the small rectangular box on the right side of the helmet. Although very similar to the military system, some of the features are more limited in range and the computer/video link is not one of the available features.

The solid plate visor can be flipped up to reveal the wearer's face, but is locked into place during combat or when the environmental systems are engaged.

1. Normal Optics and Split View Screen/Projection: A video projection simulates normal color vision. Video images are displayed on the HUD same as "cyclops" helmet.
 2. Standard Optical Enhancements: Passive night vision (2000 foot/610 m range), telescopic (5× magnification, 6000 foot/1830 m range), and light filters.
 3. A miniature multi-purpose computer shows system errors within the armor, damage levels, and oxygen supply, and that also functions as a calculator and clock indicating time (can be used a stopwatch and alarm clock too), date, direction (compass).
 4. Laser distancer indicating distance of a target or item. Maximum effective range: 1000 feet (305 m).
 5. Laser Targeting: Adds a +1 strike bonus. Maximum effective range: 1000 feet (305 m).
- M.D.C.: 70
 - Weight: 12 lbs (5.4 kg)
 - Excellent mobility! No prowl penalty.
 - Market Cost: 50,000 credits. New; currently poor availability due to high demand and low production. Should reach relatively good availability levels by 106 P.A.
 - Colors: Light green, dark green, light grey, medium grey, tan, black, white or camouflage.

T-43 Explorer

Mass Market Full Composite Body Armor

German Name: der Forscher

The Explorer is an all-purpose, heavy padded, kelvar, and plate composite armor. It is designed for quick and easy attachment of a jet pack, or other backpacks, directly to the armor. The Falcon 300 Jet pack is the standard attachment, although the military jet pack and the Wilk's jet pack can also be used.

- M.D.C. 70
- Weight 20 lbs (9 kg)
- Fair/poor mobility, -20% prowl penalty.
- Market cost: 45,000 credits
- Colors: Light green, dark green, light grey, medium grey, tan, black, white or camouflage.

Falcon 300 Jet Pack accessory for the T-43

The Falcon 300 is the jet pack specifically designed for use with the T-43 Explorer. It is popular among mercenaries, messengers and wilderness folk.

- Maximum Speed: 120 mph (192 km)
- Maximum Range: 600 miles to 900 miles (960 to 1440 km)
- Weight: 35 lbs (15.75 kg)
- Length: 3 ft (0.9 m)
- Weapons: None.
- M.D.C.: 18
- Cost by Engine Type: 30,000 credits Gasoline. Range: 600 miles (960 km; 200 miles/321.8 km to the gallon — three gallon/11.4 liter tank).
46,000 credits for an electric/rechargeable battery type. Range: 800 miles (1280 km maximum, about 200 miles an hour — four hours of energy).

400,000 credits for nuclear engine with a 10 year life. The range is effectively unlimited, but the jet pack begins to overheat if used continuously for more than four hours. Overheating will burn out the internal systems, destroying the jet pack. It should be allowed to cool two hours after every two or three hours of continuous use; four hours max! After four hours of use, there is a 1-40% chance of overheating every 20 minutes after the four hour limit.

The Explorer

Full Composite Body Armor

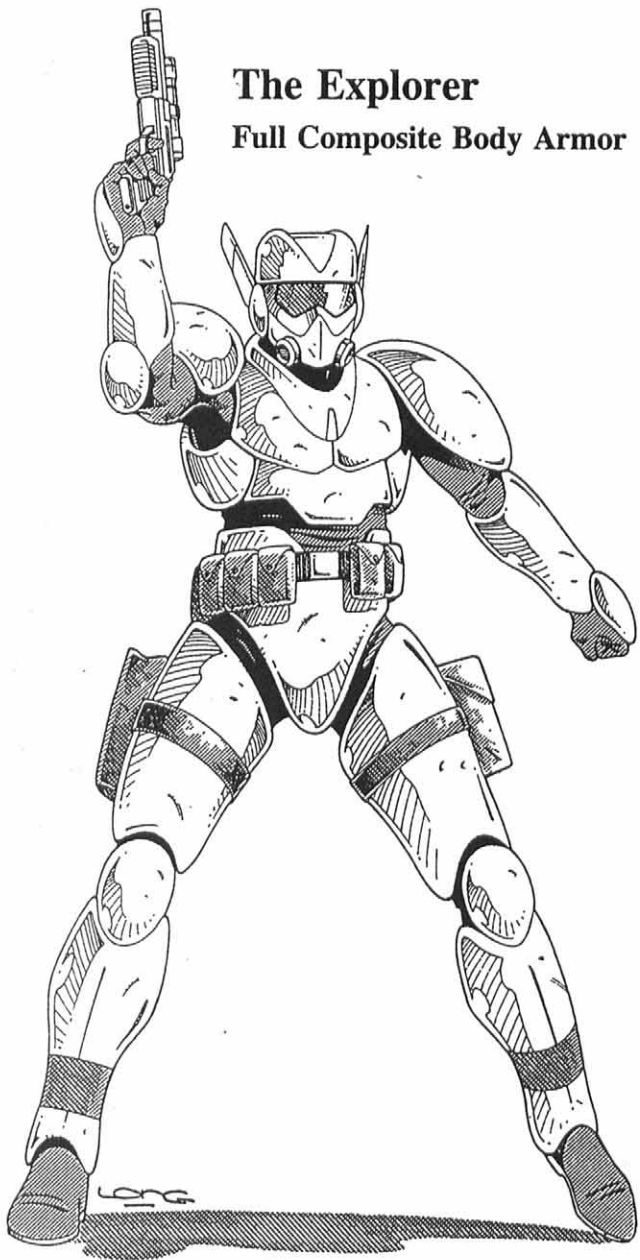

Other Styles of Armor

Mass Market Body Armor

Gladiator, Crusader, Juicer and Urban Warrior types and styles of armor are also available to the mass market in and around the New German Republic. Most of these are produced by manufacturers other than Triax Industries. See the **Rifts RPG**, pages 209 and 210, for descriptions. These environmental suits are typically 15% less in Europe than the Americas.

G-10 Soldier

The G-10 Soldier is a cheap “knock-off” of the NGR military body armor. The most noticeable difference is the absence of the “cyclops” helmet and its unique optics, sensors and HUD capabilities. The helmet more resembles that of the T-41 Riot suit. Otherwise the body styling is the same. However, this armor is heavy, bulky, and provides less mega-damage protection than the NGR combat armor. Triax and the NGR have decided not to take action against the manufacturer as long as it does not make the armor in military colors, including camouflage.

- M.D.C.: 60
- Weight: 20 lbs (9 kg)
- Fair mobility, -10% prawl penalty.
- Market cost: 25,000 credits; good availability.
- Colors: Light green, dark green, light red, deep red, black, chrome silver and tan.

T-Series Triax Power Armor

Triax T-21 Terrain Hopper Power Armor

The Terrain Hopper is a lightweight suit of environmental power armor designed for comfort and extreme mobility while providing maximum protection. It is fast and maneuverable, making it ideal for reconnaissance, rescue, and exploration. It is especially popular among women, D-Bees of slight build, and wilderness messenger services. It is also popular among businessmen and adventurers in and around the NGR. The T-21 is one of the few mass market styles of power armor exported by Triax to the Americas and Europe. It can also be purchased by the civilians living in the NGR.

The Terrain Hopper is fitted with a detachable jet pack that provides limited, low altitude flight. The jet pack is not designed for prolonged flight. The ideal method of travel by this armor is via jet-assisted leaps. In fact, the name *Terrain Hopper* is derived from the suit’s ability to hop rather than run or fly. The jet pack is tied directly into the power armor and the boosters will automatically engage every time its operator runs and leaps. Motion detectors and sensors in the feet indicate velocity and the moment when both feet have left the ground. At that instant, the booster jets kick in, hurling the character in a power leap 20 to 50 feet (6 to 15 m) into the air and that carries the wearer approximately 300 feet (91.5 m) lengthwise/forward or backwards. The jet assisted leaps can be done indefinitely without fear of overheating and gives the wearer great ground speed and all-terrain capabilities.

Note: The standard, mass market Terrain Hopper does not come equipped with any weapon systems. The pilot must arm himself with a hand-held weapon or the armor must be modified by an underground or independent armorer. Modified T-21 Terrain Hoppers are not allowed into the cities without government or military authorization.

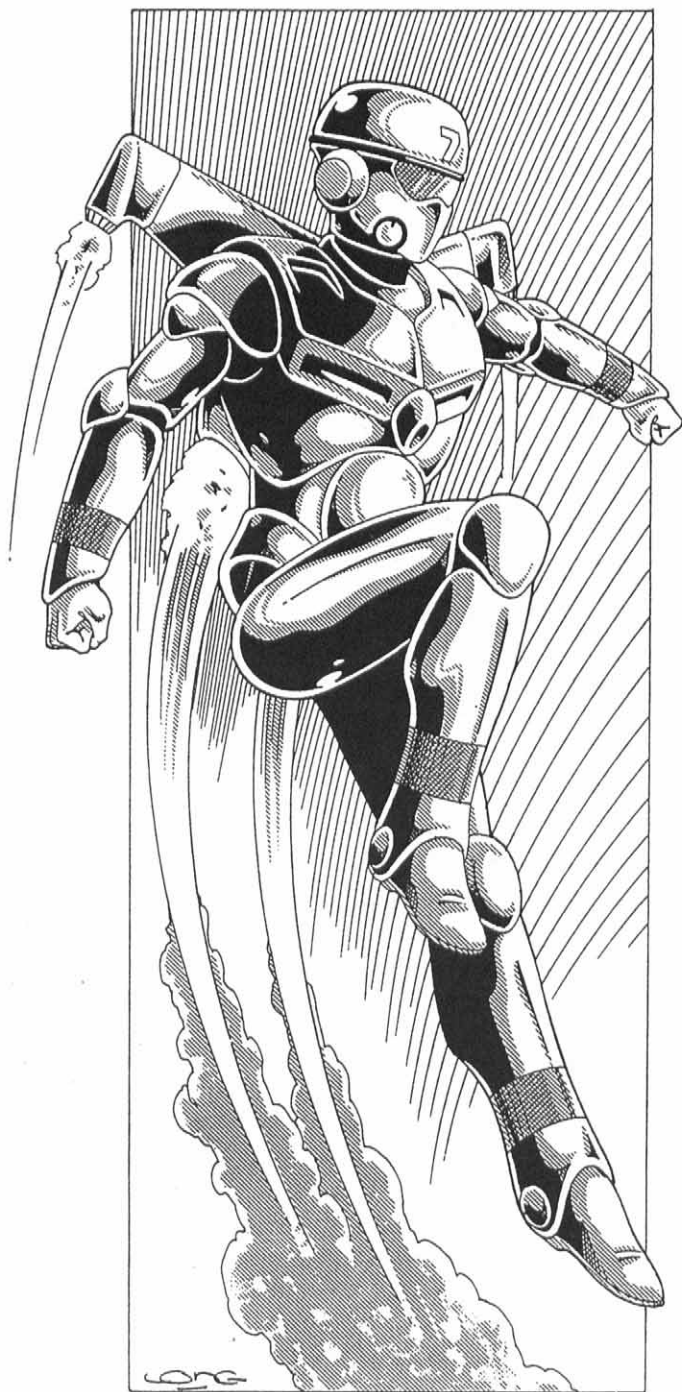

T-21 Terrain Hopper Power Armor

German Name: der Gelaendehuepfender
(pronounced: ga lane de hoop fen dare)

Model Type: T-21 Power Armor

Class: Strategic Armor Military Exo-Skeleton

Crew: One

M.D.C. by Location:

Rear Jet Pack (1) — 50

Chest Headlight (1) — 2

*Head — 60

**Main Body — 170

*Destroying the head/helmet has a 1-70% chance of knocking the pilot unconscious. If conscious, the pilot has two problems. One, no power armor combat bonuses to strike, parry, and dodge. Two, the human head is now vulnerable to attack. **Note:** The head is a small and difficult target to

hit (shielded by exhaust tubes). Thus, it can only be hit when an attacker makes a *called shot* and even then the character is -3 to strike.

Depleting the M.D.C. of the main body will shut the armor down completely, making it useless. **Note: Destroying the jet pack will make power jumps impossible.

Speed

Running: 40 mph (64 km) maximum. The act of running does tire its operator, but at a fatigue rate of 20% of normal, thanks to the robot exo-skeleton.

Leaping: A height of approximately 15 feet (4.6 m) straight up or lengthwise is possible, unassisted by the thrusters. A *jet thruster assisted leap from a stationary position* can propel the unit up to 200 feet (61 m) high and across without actually attaining flight or requiring a running start.

Power Jumping and travel: The integrated jet pack enables the power armor to leap great heights and distances. Getting a running start will enable the individual to leap up to 300 feet (91.5 m) lengthwise. The height of the leap is controlled by the pilot and generally ranges between 20 to 50 feet (6 to 15 m); with 20 or 30 feet of height being the norm. By leaping, landing, continuing to run a few dozen yards/meters, and power leaping again, the T-21 pilot can attain and maintain an impressive ground speed of 170 mph (272 km), even through light forests. Speed should be reduced to 40% when travelling through dense vegetation or hazardous terrain. Failure to do so will result in jarring and potentially damaging collisions and accidents.

Directional control by the pilot is excellent. The capabilities of the jet pack allows the pilot to stop in mid-air, change direction/trajectory and hover. However, having to suddenly engage the jet pack in mid-flight to avoid a collision or bad landing may slow one's speed and make the character an easier target for attack. Likewise, crashing through the underbrush makes a lot of noise, alerting predators and the enemy to one's presence, and reduces the pilot's vision and awareness (-3 on initiative, -1 to strike, parry, and dodge due to obscured vision and rate of travel).

Limited Flight: The rocket propulsion system enables the T-21 to hover stationary up to 200 feet (61 m) or fly. Maximum flying speed is 100 mph (160 km), but cruising speed is considered to be around 60 mph (96.5 km). Maximum altitude is limited to about 200 feet (61 m).

Flying Range: The nuclear power supply of the armor gives it a decade of life, but the jet rockets get hot and need to cool after a maximum of two hours of continuous flight. In many cases, the jets will start to sputter and speed will fluctuate after one hour. This is especially true if the jets have been damaged. Remember, traveling by power jumps can be maintained for an unlimited number of hours at a greater speed of 170 mph (272 km).

Statistical Data

Height: 7 feet (2.1 m)

Width: 3 feet (0.9 m)

Length: About 2.5 feet (0.63 m)

Weight: 100 lbs (45 kg) with jet pack.

Physical Strength: Equal to P.S. 20.

Cargo: None

Power System: Nuclear, average life is 10 years.

NGR Cost: 500,000 credits for a new, undamaged, fully powered

suit, complete with jet pack. Excellent availability at the NGR, fair to good availability in other European and Coalition cities; scarce everywhere else.

Weapon Systems: None. The wearer must use a hand-held weapon.

Special Sensors and Optics: The helmet is equipped with full optical systems, including laser targeting, telescopic sight, passive nightvision (light amplification), thermo-imaging, infrared, ultraviolet, and polarization. Plus all other features common to all power armor.

Sensor Bonuses: +1 to strike is applicable to long range weapon combat only. Hand to hand: +1 to parry and dodge, automatically +2 to dodge while traveling by means of power jumps. See *Power Armor Combat Training* in the Robot Combat section of the **Rifts RPG**, page 45, for other bonuses.

Triax T-C20 Terrain Hopper Power Armor

The T-C20 is the combat version Terrain Hopper. It is used by the military and Triax Industry investigators. Except for built-in weapon systems and heavier armor, the T-C20 is virtually identical to the non-combat version. Unlike the T-21, the combat hopper is not currently sold to other kingdoms. However, since it is a light infantry and reconnaissance armor easily overpowered by Triax's more advanced and heavy weapon bots and power armor, it is being considered for mass marketing.

T-C20 Terrain Hopper Power Armor

Model Type: T-C20 Power Armor

Class: Strategic Armor Military Exo-Skeleton

Crew: One

M.D.C. by Location:

Rear Jet Pack (1) — 50

Rear Mini-Missile Launcher (1) — 50

Chest Headlight (1) — 2

Forearm Laser (2, one each arm) — 10

*Head — 70

**Main Body — 200

*Destroying the head/helmet has a 1-70% chance of knocking the pilot unconscious. If conscious, the pilot has two problems. One, no power armor combat bonuses to strike, parry, and dodge. Two, the human head is now vulnerable to attack. **Note:** The head is a small and difficult target to hit (shielded by exhaust tubes). Thus, it can only be hit when an attacker makes a *called shot* and even then the character is -3 to strike.

Depleting the M.D.C. of the main body will shut the armor down completely, making it useless. **Note: Destroying the jet pack will make power jumps impossible.

Speed

Running: 40 mph (64 km) maximum. The act of running does tire its operator, but at a fatigue rate of 20% of normal, thanks to the robot exo-skeleton.

Leaping: A height of approximately 15 feet (4.6 m) straight up or lengthwise is possible unassisted by the thrusters. A *jet thruster assisted leap from a stationary position* can propel the unit up to 200 feet (61 m) high and across without actually attaining flight or requiring a running start.

Power Jumping and travel: Same as the T-21: Up to 300 feet (91.5 m) lengthwise, average height of a controlled power jump generally ranges between 20 to 50 feet (6 to 15 m); with 20 or 30 feet (6 to 9 m) being the norm. Maximum ground speed via power leaps is 170 mph (272 km). Range is effectively unlimited. Directional control by the pilot is excellent.

Limited Flight: Same as the T-21: Hover stationary up to 200 feet (61 m). Maximum flying speed is 100 mph (160 km), but cruising speed is considered to be around 60 mph (96.5 km). Maximum altitude is limited to about 200 feet (61 m).

Flying Range: The nuclear power supply of the armor gives it a decade of life, but the jet rockets get hot and need to cool after a maximum of two hours of continuous flight. In many cases, the jets will start to sputter and speed will fluctuate after one hour. This is especially true if the jets have been damaged. Remember, traveling by power jumps can be maintained for an unlimited number of hours at a greater speed of 170 mph (272 km).

Statistical Data

Height: 7 feet (2.1 m)

Width: 3 feet (0.9 m)

Length: About 2.5 feet (0.76 m)

Weight: 150 lbs (68 kg) with jet pack, missiles and additional armor.

Physical Strength: Equal to P.S. 23.

Cargo: None

Power System: Nuclear, average life is 10 years.

NGR & Black Market Cost: 750,000 credits for a new, undamaged, fully equipped suit complete with jet pack and weapon systems. Good availability at the NGR. Poor availability in other European locations; scarce everywhere else.

Special Sensors and Optics: The helmet is equipped with full optical systems, including laser targeting, telescopic sight, passive nightvision (light amplification), thermo-imaging, infrared, ultraviolet, and polarization. Plus all other features common to all power armor.

Sensor Bonuses: +1 to strike is applicable to long range weapon combat only. Hand to hand: +1 to parry and dodge, automatically +2 to dodge while traveling by means of power jumps. See *Power Armor Combat Training* in the Robot Combat section of the **Rifts RPG**, page 45, for other bonuses.

T-C20 Weapon Systems

1. Forearm Lasers (2): A lightweight laser is built into each of the forearms. The suit's operator need only point and shoot.

Primary Purpose: Assault

Secondary Purpose: Defense

Weight: Built into the power armor.

Mega-Damage: Two damage settings: 1D6 or 3D6 M.D. per single blast.

Rate of Fire: Equal to the number of combined hand to hand attacks of the person in the suit (usually 4-6).

Maximum Effective Range: 2000 feet (610 m)

Payload: Effectively unlimited.

2. Back mounted Mini-Missile Launcher: A small mini-missile launcher is hooked onto the back of the jet pack.

Primary Purpose: Anti-Aircraft/Anti-Gargoyle

Secondary Purpose: Defense

Missile Type: Any mini-missile can be used, but standard issue is armor piercing (1D4 × 10 M.D.) or plasma (1D6 × 10 M.D.).

Fragmentation will be used for anti-personnel operations.

Mega-Damage: Varies with missile type.

Range: Usually about a mile.

Rate of Fire: One at a time or volleys of two.

Payload: Six

3. **Energy Rifle, Light Rail Gun**, and other man-size weapons can be carried into combat. Sidearm (pistol), knife, sword, hand grenades, etc., can be carried on a belt at the waist or across the chest. The T-C20 pilot is - 3 to strike when leaping or flying.

Triax T-31 Super Trooper Robot Destroyer Power Armor

The T-31 Super Trooper is a man-size power armor designed as an anti-tank/armor assault unit. The T-31 provides its wearer with heavy, close-range firepower for the specific purpose of *penetrating* armor, whether it be giant robots, tanks or APCs. Tactically, the Super Trooper is most frequently used in seek and destroy missions, advanced assaults, and to punch through enemy defenses. The T-31 is heavier and slower than most infantry power armor, but makes up for what it loses in speed and mobility with firepower and a versatility of weapon systems.

When combating giant robots or large armored vehicles, a squad of Super Troopers rush toward the enemy. As small, man-size targets, they are more difficult to hit and, in the confusion of combat, may be mistaken for ordinary soldiers. When the target has been reached, the T-31 makes a jet powered leap and adheres itself to its giant, armored objective, like a tick on a hound dog. In many instances, giant bots and armored vehicles have little or no defense against a man-size enemy clinging to its body. In other instances, there are blind spots where the super trooper can cling out of sight, penetrate the armor, or launch some other type of attack. Once attached, the power armor earns its nickname "The Can-Opener." Using its vibro-blade, lasers, explosives or missiles, the pilot "carves up" the armored enemy unit. Vital areas, joints, weapon barrels, turrets and sensor housings are usually the primary targets — the plan being to blind and cripple the enemy rather than completely destroy it. Then, move on to the next.

T-31 Super Trooper Power Armor

Exclusive to the NGR Military

German Name: der Ueberkavallerist
(pronounced: oo bare kava lare ist)

Model Type: T-31

Class: Strategic Armor Military Assault Suit

Crew: One

M.D.C. by Location:

Shoulders/Upper arm (2) — 90 each

Forearms (2) — 70 each

Legs (2) — 120 each

Leg Mini-Missile Launchers (2, lower leg) — 30 each

Fusion Launchers (2, above each shoulder) — 50 each

Maneuvering Jets (8, small) — 15 each

*Head — 75

**Main Body — 250

*Destroying the head of the power armor will eliminate all forms of optical enhancement and sensory systems. The pilot must rely on his own human vision and senses. Any power

armor combat bonuses to strike, parry, and dodge are lost!
Note: The head is a small and difficult target to hit (shielded by the armored neck collar and fusion launchers). Thus, it can only be hit when a character makes a *called shot*, but even then the attacker is - 4 to strike.

**Depleting the M.D.C. of the main body will shut the armor down completely, rendering it useless.

Speed

Running: 40 mph (64 km) maximum. Note that the act of running does tire its operator, but at 10% of the usual fatigue rate thanks to the robot exo-skeleton.

Leaping: The powerful robot legs can leap up to 12 feet (3.6 m) high or lengthwise unassisted by the thrusters. A *jet thruster assisted leap* propels the unit up to 60 feet (18.3 m) high and 100 feet (30.5 m) lengthwise.

Flying: Flight is not possible. Nor are high speed, continuous leaps like the Terrain Hopper. The rocket propulsion system is designed to enable the T-31 to leap up onto (and down from) giant bots and armored vehicles and to better roll with impact/falls.

Statistical Data

Height: 7 to 8 feet (2.1 to 2.4 m) from head to toe; the shoulder mounted missile launchers add another foot to the overall height: 8 to 9 feet (2.4 to 2.7 m).

Width: Wings 4 feet (1.2 m)

Length: 3 feet (0.9 m)

Weight: 450 lbs (202.5 kg)

Physical Strength: Equal to a P.S. 30

Cargo: None

Power System: Nuclear, average energy life is 11 years.

Black Market Cost: 1.8 million credits for a new, undamaged, fully powered suit with complete weapon systems. Poor availability. This power armor suit is exclusive to the NGR military; it has never been made available to the mass market.

Note: The T-31 has a self destruct mechanism to prevent the armor and its technology from falling into enemy hands.

T-31 Weapon Systems

1. **F4-Dual Fusion Shoulder Launchers (2):** A pair of special mini-missile launchers are mounted on the shoulders of the Super Trooper. Unlike the fast and far flying conventional mini-missile, as found used in the leg launchers, the F4 launchers fire fusion block missiles! The term "missile" is probably not the best description for these explosives. The F4 explosives are powerful fusion blocks contained in squat, barrel shaped canisters that more resemble small depth charges than sleek and slender missiles. Each F4 missile has an electromagnetic nose that releases an additional adhesive goo upon impact to help hold it in place, especially on non-metallic surfaces.

Typically, the Super Trooper uses the F4 explosives as a precision, tactical assault weapon to punch large holes into the hull of giant robots or vehicles (allowing the trooper entrance into the vehicle/bot), to blow off an arm, leg or other appendage (usually at a joint), to knock out sensor arrays (blind the enemy), and to destroy weapon turrets (impair the enemy). As a result, the F4 launcher is a short range weapon (300 feet/91.5 m). Each explosive can be set independently via voice command, or by hand, to explode on impact or time delay. The time delay can be set for 3 to 30 seconds.

The delay feature enables the power armor pilot to place the charge exactly where he wants, and get out of harm's way. The delay and magnetic/adhesion features also gives the Super Trooper the opportunity to detach the F4 canister and reposition it by hand, if necessary or desired.

The two launchers can tilt 90 degrees forward/down and backward/up.

Note: Fusion blocks are much more sensitive than the conventional explosive missile. Sometimes the trigger mechanism is jarred loose, preventing detonation. Consequently, the player must roll percentile dice each time his character uses an F4 missile. A roll of 01-65 means everything goes according to plan. 66-85 means the timer is faulty and it explodes 2D6 seconds sooner or later than it is suppose to (G.M.'s discretion). 86-00 means it's a dud. Duds are abandoned, destroyed, or retrieved and returned for reconditioning. The NGR prefers that the F4 missile be destroyed or retrieved to keep Triax technology out of the hands of the enemy. An F4 missile can be destroyed by inflicting 8 M.D. — it does NOT detonate when destroyed, but is blown into dozens of unrecognizable peices.

Further note that the F4 explosion is very concentrated and does not have a large blast radius. Nor does it cause fragmentation damage. Again, this is because the weapon is designed as a *precision* assault weapon meant to penetrate enemy armor or to disable a weapon or appendage in one shot.

Primary Purpose: Tactical Anti-Armor Weapon; penetrate and destroy.

Missile Type: Special short-range fusion missiles only. Conventional mini-missiles can not be used in these launchers.

Mega-Damage: 2D6 × 10 M.D.; blast area is 10 feet (3 m).

Range: 300 feet (91.5 m)

Rate of Fire: One or two.

Payload: A total of four; two per each launcher.

2. MAE-3 Hand Charges (also known as: Maysies): Located in the chest of the T-31 Super Trooper are a pair of round disks. These are also explosives. A third, larger disk is located in the belly of the armor. All three Maysies are explosive charges used for damaging and penetrating enemy armor. The outside of the disk is made of the same mega-damage armor as the rest of the suit, protecting the internal detonator and explosives. The explosives are "plastique," which means it cannot be detonated by jarring, heat, energy blasts or another explosion. The only thing that can cause detonation is the detonating device or an *electrical charge*. The Maysies and the T-31 armor have electrical dampening and grounding to prevent accidental detonation, but there is a chance of them exploding when struck by lightning or other powerful electrical discharges (roll for each MAE-3; 01-20 means detonation, 21-00 means no damage). Fortunately, the enemy is not aware of this weakness or any of the unique features of the Super Trooper power armor.

To use a Maysie, the power armor pilot removes the disk with a voice command and a twist of his hand. The timer is then set and the explosive can be "placed" at the desired location. The hard armor side always faces toward the trooper, focusing the explosive force into the enemy target. The time delay offers a range of three seconds to five minutes.

Although never intended to be thrown, the MAE-3 disk is also reasonably aerodynamic which means it can be activated

and thrown like a Frisbee or discus. However, the explosive disk weighs 15 pounds (6.8 kg) and cannot be tossed more than 1D6 feet (1D6 × 0.3 meters) by the average person. Only characters with a strength of 20 to 30 (or supernatural strength) can toss a Maysie with any accuracy or distance: 1D4 × 10 yards/meters, but is -4 to strike.

The MAE-3 uses a revolutionary form of molecular adhesion that was being developed before the Time of the Rifts. Triax has only recently recreated that technology. The use of the molecular adhesion system means the explosives can be attached to virtually any surface! The Molecular Adhesion Explosives (MAE) system is a closely guarded secret. Super Trooper pilots are expected to destroy the Maysies or themselves when under the threat of capture. Note that most enemy forces and even the soldiers in other branches of the military are not aware of how the MAE-3 works.

Primary Purpose: Tactical Anti-Armor Weapon; penetrate and destroy.

Missile Type: Special high explosive; hand placed charge.

Mega-Damage: 1D6 × 10 M.D. with a blast area of 5 feet (1.5 m) for the two small disks and 2D4 × 10 M.D. with a blast area of 10 feet (3 m) for the one large disk.

Range: The T-31 Super Trooper, with its P.S. of 30, can toss a MAE-3 disk approximately 1D4 × 10 + 30 yards (a maximum of 210 feet or 64 m, 120 ft/36.5 meters minimum), but has no bonuses to strike; natural dice rolls only. The disks are designed to be "placed" or tossed only a few feet not actually thrown long distances like a grenade or a frisbee.

Rate of Fire: One per melee action.

Payload: Three total; two small and one large.

3. Leg Mini-Missile Launchers (2): A small mini-missile launcher, holding seven (7) mini-missiles, is mounted on the calf of each leg.

Primary Purpose: Anti-Aircraft

Secondary Purpose: Defense

Missile Type: Any mini-missile can be used, but standard issue is armor piercing (1D4 × 10 M.D.) or plasma (1D6 × 10 M.D.). Fragmentation is seldom used by these anti-armor units.

Mega-Damage: Varies with missile type.

Range: Usually about a mile.

Rate of Fire: One at a time or volleys of two, three or four.

Payload: 14 total; seven missiles in each leg.

4. RVB-31 Vibro-Blade: A standard vibro-blade short sword is concealed in a housing in the right arm. The blade is used to cut or stab through thin armor and to sever cords and hoses. Its inclusion in the T-31's armaments has helped to contribute to the power armor's nickname of "The Can-Opener."

Mega-damage: 2D4 M.D.

Range: Hand to hand combat.

5. LGL-31 Grapnel & Launcher: On the left arm is a housing that looks identical to the RVB-31, but it is really a launcher that fires a grappling hook and line. The grappling hook is used to scale non-metallic surfaces or as an alternate means to secure oneself to giant bots and vehicles.

Mega-Damage: None

Range: 100 feet (30.5 m) of lightweight cord (retractable).

6. PL-31 Palm Laser Torch (2): What would the "Can-Opener" be without a laser torch to cut through armor, locks, and hoses? Thus, located at the base of the palm and wrist of each hand is a very short range, but very high intensity laser torch.

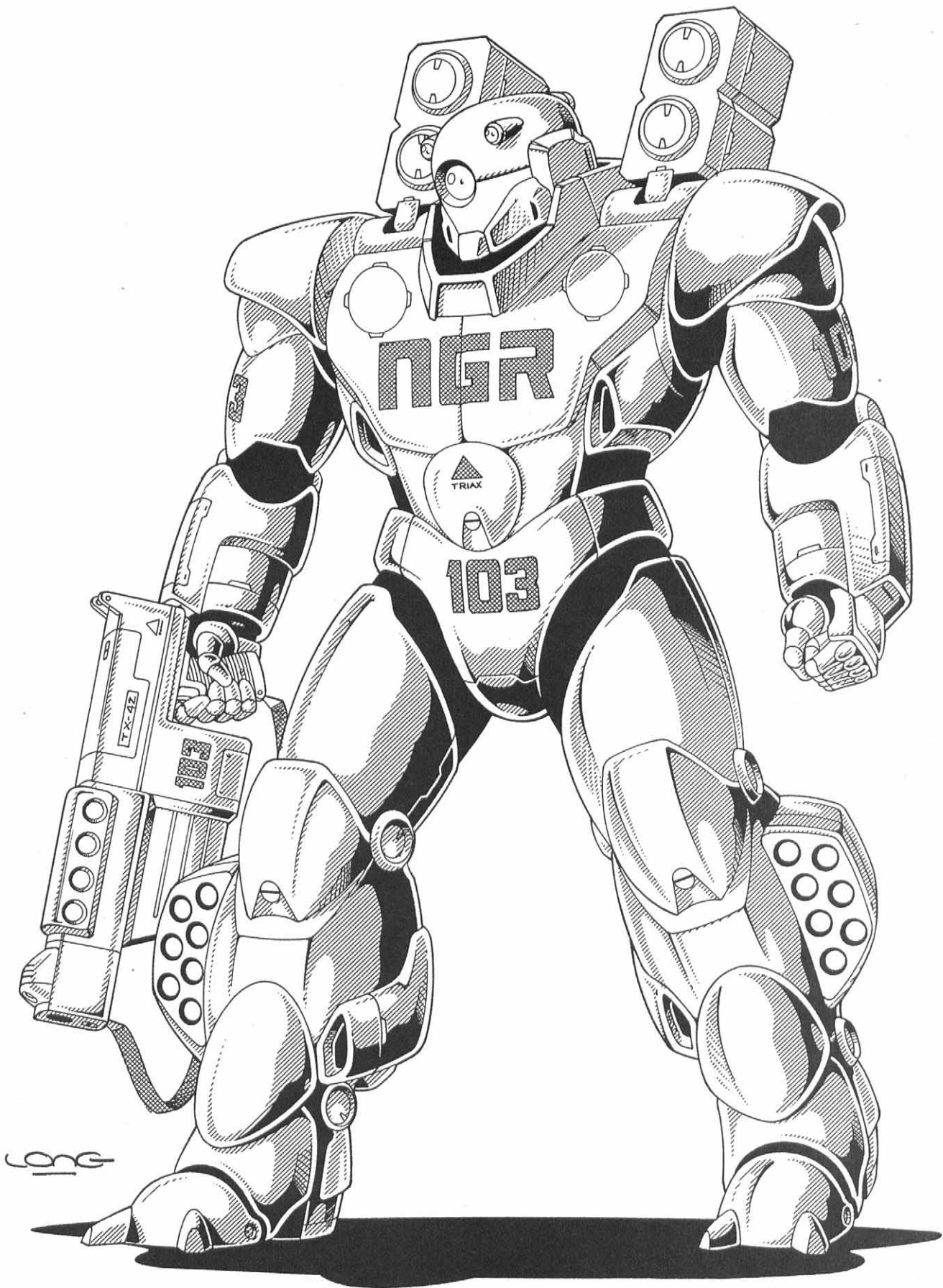

Primary Purpose: Tactical Anti-Armor tool.
Mega-Damage: 3D6 per single blast or 6D6 per double blast (both hands combined). Blast area is 10 feet (3 m).
Range: One foot (0.3 m)

Rate of Fire: Equal to the number of hand to hand melee actions of the pilot (plus power armor bonuses).
Payload: Effectively unlimited.

7. **Energy Rifles, Light Rail Guns** and other weapons can be carried and used by the roughly man-sized Super Trooper. The TX-42 variable pulse laser is standard issue, but the TX-50 or other weapons can be substituted. Officers may also wear a waist belt and a sidearm (energy pistol) or carry an additional vibro-blade.

8. **Hand to Hand Combat:** Rather than use a weapon, the pilot can engage in mega-damage hand to hand combat. See *Basic and Elite Power Armor Combat Training* in the Robot Combat section of **Rifts**, page 45. All abilities are the same except as follows:

Normal Punch or Kick — 1D6 M.D.

Power Punch — 2D6 M.D., but counts as two melee attacks.

Jet Assisted Leap Kick — 2D6+2 M.D., but counts as two melee attacks.

Jet Assisted Body Slam/Ram — 1D6+2 M.D.

9. **Sensors & Systems of Note:**

1. The T-31 Super Trooper has full optical systems, including laser targeting, telescopic, passive nightvision (light amplification), thermo-imaging, infrared, ultraviolet, and polarization. It also has all the other features common to most power armor. Sensor Bonuses: +2 to strike is applicable to the use of all weapon systems except the MAE-3. See *Power Armor Combat Training* in the **Rifts RPG** for other power armor bonuses.

2. The feet and toes have the same molecular adhesion systems as the MAE-3. A special self-destruct system is also part of the feet, enabling the power armor pilot to destroy the adhesion system with minimal damage to his armor. This technology cannot fall into the hands of the enemy. The toes provide footholds for climbing and balance.

3. Distress Homing Beacon. All T-31s are equipped with a radio, scrambled, homing signal for location and extraction from combat zones. Before the gargoyles, brodkil and other monsters began to use modern equipment, the homing signal was completely undetectable by the enemy. Now, as the enemy learns to use high tech equipment and sensors, they can detect and track radio signals. Still, the beacon is reasonably safe, with a 01-30% chance of detection by the enemy.

Triax T-550 Glitter Boy

The Triax Glitter Boy is the newest addition to the New German Republic's military. Currently there are only 64 T-550s active in the NGR, but that number should increase six times by the end of 104 PA and 20 times by the end of 105 PA. This new Glitter Boy is a sleeker, somewhat smaller version of the North American-G10 Glitter Boy used by the Coalition State of Free Quebec. In addition to the changes in size and physical styling, the Triax Glitter Boy has several additional support weapons built into its overall armaments. These include mini-missiles, a laser and a vibro-sword. The basic operation, mechanics and functions for the "Boom Gun," recoil suppression system, feet pylons, and laser reflective armor remain unchanged.

The creation of the Triax Glitter Boy has been made possible only from a technologies trade agreement between the NGR and Free Quebec. The original Glitter Boy technology was developed by an American corporation before the Great Cataclysm. After-

wards, the secrets of the infamous Glitter Boy, its boom gun and its unique laser resistant armor had been lost. Only Free Quebec was able to unearth the old GB technology, a secret they have never shared until now. This turn of events has not made Emperor Prosek a happy man and may cause Free Quebec some trouble in the future. Meanwhile, this technology agreement will provide Free Quebec with over two hundred Glitter Boys, including several dozen of the new Triax version. This development has also sparked interest by other Coalition factions to pursue the alliance proposed by the NGR.

Note: Unknown to Emperor Prosek and the other Coalition States, Triax and the NGR have also agreed to share the complete manufacturing information and techniques behind the T-550 with Free Quebec. This information will enable the State to build its own T-550 manufacturing facility, although that will take three or four years to accomplish. Furthermore, such a manufacturing plant is in direct conflict with Quebec's current agreement with the rest of the CS. Still, Free Quebec likes to have this option available to them.

T-550 Glitter Boy Power Armor

Exclusive to the NGR Military and CS Free Quebec

German Name: der Glizernjunge

(pronounced: glitz airn yung eh)

Model Type: T-550

Class: Laser Resistant Strategic Armor Military Assault Suit

Crew: One

M.D.C. by Location:

*Head — 200

Hands — 75 each

Arms — 200 each

Legs — 400 each

Leg Stabilizer Units (2) — 60 each

Boom Gun (1, right shoulder) — 150

Rear Ammo Drum (1) — 150

Vibro-Sword (1) — 30

Chest Spotlight (1) — 3

**Main Body — 650

*Destroying the head of the power armor will eliminate all forms of optical enhancement and sensory systems. The pilot is forced to rely on his own human vision and senses. Furthermore, all power armor combat bonuses to strike, parry, and dodge are lost! **Note:** The head is a small and difficult target to hit. Consequently, it can only be hit when a character makes a *called shot* and even then the attacker is -3 to strike. The two nozzles at the top of the head are part of the sensor system.

Depleting the M.D.C. of the main body will shut the armor down completely, rendering it useless. **Note: Laser weapons do half damage!

Speed

Running: 60 mph (96 km) maximum. Note that the act of running does tire out its operator, but at 20% of the usual fatigue rate thanks to the robot exo-skeleton.

Leaping: The powerful robot legs can leap up to 10 feet (3 m) high or 15 feet lengthwise (4.6 m) from a short running start.

Flying: Flight is not a capability of the T-550.

Statistical Data

Height: 9 feet (2.7 m) from head to toe, or 10 feet (3 m) with boom gun in firing position.

Width: 3 feet, 9 inches (1.1 m)

Length: 4 feet (1.2 m), including ammo drum and recoil suppression system. 8 feet (2.4 m) from the nose of the gun to the back when the weapon is in firing position.

Weight: 2 tons

Physical Strength: Equal to a P.S. 30

Cargo: A tiny storage space provides a place for a rifle, handgun, survival knife, two signal flares and food rations.

Power System: Nuclear, average energy life is 11 years.

Black Market Cost: 60+ million credits for a completely equipped T-550 Glitter Boy. The black market has yet to acquire one of these suits. No availability.

Note: The T-550 has a self destruct mechanism to prevent the armor and its technology from falling into enemy hands.

Weapon Systems

1. TX-550 Boom Gun/Rail Gun (1): This Triax version of the Boom Gun, like its predecessor, fires flechette style rounds at a speed of Mach 1.5 (slightly slower than the Mach 2 of the original) and actually creates a sonic boom when fired. The weapon is the first successful *duplication* of this Pre-Rifts weapon, but the Triax design departs significantly from the original, combining laser targeting, an independent computer radar tracking system and precision automated targeting calibration. When the gun is activated, the computer tracking and targeting system take over, instantly seeking out the nearest target, or a specific target designated by the pilot. It then tracks that target, automatically adjusting the angle of the gun. The Boom Gun can be set to fire automatically the instant the enemy is targeted, or to target and wait for the pilot's signal. Or the GB pilot can personally control and direct movement of the gun, targeting and shooting via voice command. Either way, the pilot never needs to physically touch the Boom Gun. This leaves both hands free to operate other weapons and equipment.

The Boom Gun can angle itself forward and upward in a straight line, 60 degree arc of fire, but cannot pivot from side to side. To strike a target off to the side, the entire power armor must be turned to face that direction. Again, the radar-targeting computer will help direct the pilot to achieve the proper alignment. When not in use, the gun barrel rotates to an upward position and locks into place. Yes, it can fire in the upward position.

The blast from the big gun is so powerful that without the automatic stabilization and recoil suppression system, the T-550 Glitter Boy would be thrown backwards and to the ground. Like its American predecessor, retractable reinforced pylons in the rear of the legs shoot into the ground to help hold the T-550 in place. Synchronized jet thrusters also engage to hold the power armor steady. The pylons automatically retract and the small thrusters disengage when the T-550 needs to move or reposition itself.

Primary Purpose: Anti-Armor and Anti-Gargoyle/Aircraft

Secondary Purpose: Defense

Weight: 700 lbs (315 kg), but built into the power armor.

Mega-Damage: One Boom Gun flechette round holds 200 slugs that inflict 3D6 × 10 M.D.

Effects of the Sonic Boom: The T-550 Glitter Boy armor is specially insulated from the shock waves of the Boom Gun. However, everybody within 200 feet (61 m) will be temporarily

deafened. Characters without any type of head/ear protection will be temporarily deaf for 2D4 minutes and are -8 on initiative, -3 to parry and dodge. Characters clad in environmental body armor will be deafened for half the time, 1D4 minutes, and suffer the same penalties. They will also have a terrible headache. Characters with a cybernetic sound filtration system or in power armor or bot vehicle will not be adversely affected other than by a ringing in the ears.

The sonic boom will also shatter most conventional glass and shake buildings and vehicles within a 300 foot (91.5 m) radius!

Rate of Fire: Equal to the number of combined hand to hand attacks of the pilot and his power armor (usually 4-6).

Maximum Effective Range: 11,000 feet (about two miles/3.2 km)

Payload: 100 rounds. Unlike some power armor suits, the T-550 can be reloaded by hand, one round at a time, by the pilot (takes about 15 minutes). Alternately, the empty ammo drum can be removed and a new drum canister replaced by a field mechanic in a high-low or directing a bot or borg (takes about 3 minutes).

2. TX-550 Anti-Personnel Laser (1): Located above the left shoulder is a short-range laser nozzle. The weapon can rotate 45 degrees in all directions.

Primary Purpose: Anti-Personnel

Secondary Purpose: Defense

Weight: A part of the power armor.

Mega-Damage: 3D6 M.D. per blast.

Rate of Fire: Equal to the number of combined hand to hand attacks of the pilot and his power armor (usually 4-6).

Maximum Effective Range: 1000 feet (305 m).

Payload: Effectively unlimited.

3. TX-550 Mini-Missile Launchers (4): Near the knee of each leg are a pair of mini-missile launchers. Each launcher contains three mini-missiles.

Primary Purpose: Anti-Aircraft

Secondary Purpose: Defense

Missile Type: Any type of mini-missile can be used, but standard issue is armor piercing (1D4 × 10 M.D.) or plasma (1D6 × 10 M.D.). Fragmentation may be used for anti-personnel operations.

Mega-Damage: Varies with missile type.

Range: Usually about a mile.

Rate of Fire: One at a time or volleys of two, three or four.

Payload: A total of 12; three mini-missiles in each of the four launch compartments.

4. Vibro-Sword (1; right arm): A large, retractable vibro-sword is built into the right forearm.

Primary Purpose: Defense

Mega-Damage: 5D6 M.D.

Bonuses: +1 to strike and +1 to parry when engaged in hand to hand combat.

5. Energy Rifle, Light Rail Gun or other hand-held weapons can be used by this power armor. The TX-500 is standard issue but the TX-50 or VX Maxi-Rail Gun can be substituted (the latter only for special missions; it reduces speed and maneuverability by 25%).

6. Hand to Hand Combat: Rather than use a weapon, the pilot can engage in mega-damage hand to hand combat. The

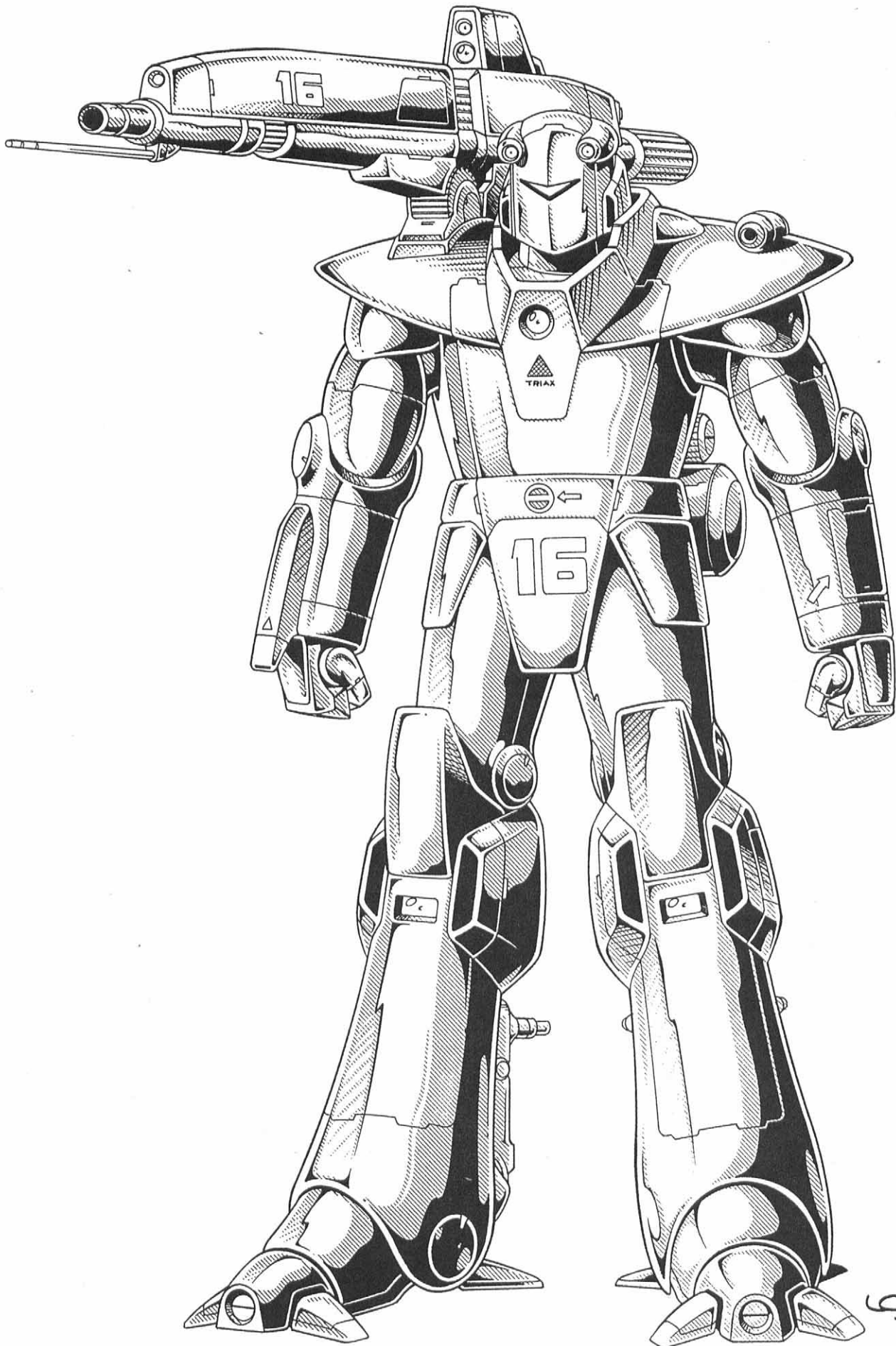

16

following bonuses are in addition to those from *Power Armor Combat Training* found in the Robot Combat section of the *Rifts RPG*, page 45.

+2 to strike with Boom Gun

+1 on initiative

+2 to roll with impact

-1 dodge penalty (-3 when pylons are engaged).

7. Sensors & Features of Note:

1. The T-550 Glitter Boy has full optical systems, including laser targeting, telescopic, passive nightvision (light amplification), thermo-imaging, infrared, ultraviolet, and polarization. It also has all the other features common to most power armor.

2. Boom Gun tracking and targeting system described previously.

3. Distress Homing Beacon (same as the T-31). All T-550s are equipped with a radio, scrambled, homing signal for location and extraction from combat zones. There is a 30% chance of detection by the enemy.

4. A combat storage space is located in the left forearm. Standard equipment includes four fragmentation hand grenades, two smoke grenades, two signal flares and a first-aid kit.

Robot Vehicles, Tanks & Power Armor

All Robots and Armored Vehicles have the following features.

1. **Nuclear Powered:** Which means they have an effectively unlimited fuel capacity and power source. Average life is 10 to 20 years.
2. **Radio Link:** The robot vehicle can tie into a sensor station, surveillance or relays satellite to access its data and sensors. Thus it can effectively increase its sensor/radar range, targeting and identification abilities and communication range.
Note that not all relays have this feature and others, especially defense and many surveillance, will allow only pre-programmed units near it and will require an access code. Failure to provide proper access requirements will result in the relay non-compliance to the link or, more likely, cause the relay to consider the robot an enemy and attack.
3. **Radar (standard):** Can identify and track up to 48 targets simultaneously at a range of 30 miles (48 km).
4. **Combat Computer:** Calculates, stores, and transmits data onto the heads-up display (H.U.D.) of the pilot's helmet. It is tied to the targeting computer.
5. **Targeting Computer:** Assists in tracking and identification of enemy targets. 30 mile range (48 km); can be extended by relays link.
6. **Laser Targeting System:** Assists in the selection and focusing of specific targets and adds a bonus of +1 to strike when using long range weapons. Does not apply to hand to hand combat.
7. **Thermo-Imaging and Infrared Optics:** Optic systems that can see heat images and the infrared spectrum of light. 2000 feet (610 m).

8. **Telescopic Zoom:** 2× to 20× magnification HUD and video-screen display. Most bots also have video recording capabilities. Range: 6000 feet (1830 m).
9. **Radio communication:** Long range, directional communication system with an effective range of about 500 miles (800 km). As well as a directional, short range radio. Range is 5 miles (8 km). Plus a built-in loudspeaker; 80 decibels.
10. **External Audio Pick-up & Loudspeaker:** A sound amplification listening system enables the bot pilot to pick up, amplify and hear a whisper 300 feet (91.5 m) away. The loudspeaker allows the pilot or crew to communicate directly with people outside the bot. Range is roughly 4000 feet (1219 m), depending on ambient noise.
11. **Internal Language Translator:** Most NGR/Triax bots have a language translator built into its communication system. The translated words can be displayed on monitors and the HUD and/or made audible via computer voice synthesizer. The computer knows the nine major languages including Euro, American, Dragonese/Elf and Gobbly. Traditional, Pre-Rifts German, Polish and Latin/Greek are also part of the program. The level of accuracy is 98.7% when translating the words of one speaker. That accuracy drops to 78% when three or more people are speaking at the same time. There is a 3 second delay from the spoken word to the translation.

Some of the major monster languages are also included in the translation program. These include: Brodkil, a dialect similar to troll (translating troll is -10% accuracy), Gargoyle, Simvan, Kittani, and Demongogian (a common tongue spoken by many of the so-called demons as well as the denizens of Wormwood). The level of accuracy is 82.5% when translating the words of one speaker, but drops to 62% when three or more creatures are speaking at the same time. There is a 3 second delay from the spoken word to the translation.

12. **Distress Homing Beacon:** All X-Series robots, tanks and APCs are equipped with a scrambled, radio homing signal used for extraction from combat zones. Before the gargoyles, brodkil and other monsters began to use modern equipment, the homing signal was completely undetectable by them. As they become increasingly familiar with high-tech equipment the enemy has a 30% chance of tracing the signal.
13. **Spotlights/Searchlights:** Most bots have at least one or two normal small spotlights. They may also have headlights or several smaller identification lights. Typical range is 600 feet (182 m).
14. **Ejector seat:** In case of an emergency, the pilot and crew can be instantly ejected (about 1000 feet) and parachute to safety. Ejection is typically done only when the bot is in imminent danger of being destroyed and the self-destruct mechanism has been activated.
15. **Self-Destruct:** A last resort measure to prevent one's robot from being captured by the enemy is the detonation of explosives inside the bot. The explosive damage is fairly self contained, destroying most of the internal systems, all computer and film data, with 2D6 × 10 M.D. However, it is very likely, 1-89% chance, that the nuclear power system will spew forth deadly levels of radiation.

16. **Voice Actuated Locking System:** The robot's access hatch(s) is sealed by an automatic locking system. A six digit spoken code programmed to a specific voice(s) pattern (six voice memory) is standard operating procedure. A manual key pad is provided in case of system failure/over-ride.
17. **Complete environmental pilot and crew compartment:** The compartment in robot power armor holds one pilot, while robot vehicles and tanks usually seat two to six people. APCs and other armored vehicles usually have a crew of 2 to 4 and accommodate a dozen to several dozen troops. In all instances, the pilot compartment is reinforced to protect the people from mega-damage that may penetrate the outer armor. It is airtight, pressurized and suitable for use in all hostile environments, including underwater (500 foot max. depth) and outer space. The following features are included.
- Computer controlled life support system.
 - Internal cooling and temperature control.
 - Air purification and circulation systems, gas filtration, humidifier/dehumidifier automatically engages when needed. Can recirculate breathable air for up to ten weeks before getting to stale too breathe.
 - Computer controlled, independent oxygen supply and purge system that automatically engages in low oxygen or contaminated air environments. Twelve hour oxygen supply in power armor, 72 hour in robot vehicles.
 - Insulated, high temperature resistant shielding for up to 400 degrees centigrade. Normal fires do no damage. Nuclear, plasma, and magic fires do full damage.
 - Radiation shielded.
 - Polarized and light sensitive/adjusting tinted observation windows (when applicable).

X-Series Power Armor & Robot Combat Vehicles

The X-series of power armor includes all power armor suits considered to be larger than man-sized. These are usually heavily armored and high-powered units above 10 feet (3 m) tall.

The distinction between power armor and armored robot vehicles starts to become blurred when trying to categorize all of the formidable creations of Triax Industries. Generally, traditional power armor is comparatively small, man-size, lightweight, and worn like a suit of armor by only one operator/pilot. Robot vehicles are typically large, 15 to 50 feet (4.6 to 15.2 m) tall, weigh tons, and are bristling with heavy weapons. Many of the larger units typically accommodate a pilot, co-pilot and/or gunner, as well as two to six passengers. Triax creations such as the X-10A Predator and Ulti-Max blur the distinction because they are smaller than the average robot vehicle, larger than the traditional power armor, and carry a large range of powerful weapons. Furthermore, these machines are not so much a suit of enhanced body armor or exo-skeleton worn over the human body, as they are a full robot operated by a single human pilot.

Although the classification arguments rage on between designers, generally, small, one-man, mobile armored units 10 feet (3 m) and smaller are considered traditional "T-series" power armor. One-man machines 11 to 20 feet (3.3 to 6 m) are considered to be X-series power armor. They are included in the "X-series" of manned robots to make the distinction from the "T-series" power armor. Large robots with a crew of two or more are categorized as X-series robot vehicles.

X-Series Power Armor & Robot Vehicles

X-10 Predator (mass market power armor)
 X-10A Predator (NGR combat version power armor)
 X-60 Flanker (power armor)
 X-500 Forager
 X-535 Jager/Hunter
 X-545 Jager-Armored (Uberjager/Super Hunter)
 X-622 Bug
 X-821 Landcrab
 X-1000 Ulti-Max (power armor)
 X-2000 Dyna-Max
 X-2700 Dragonwing
 X-2500 Black Knight
 X-5000 Devastator

The percentage composition of the NGR's X-Series combat robots:

10% X-10A Predator
 16% X-60 Flanker
 5% X-500 Forager
 25% X-535 Jager/Hunter
 9% X-545 Super Hunter
 5% X-622 Bug
 5% X-821 Landcrab
 5% X-1000 Ulti-Max
 10% X-2000 Dyna-Max
 3% X-2500 Black Knight
 6% X-2700 Dragonwing
 1% X-5000 Devastator

Triax X-10A Predator Power Armor

The X-10A Predator was developed by Triax Industries as a one-man aerial fighter to combat gargoyles and other winged enemies. This heavily armored, environmental exo-skeleton offers good mobility, speed and firepower. Although slightly slower and heavier than the Coalition's SAMAS, the X-10A Predator makes up for speed in mega-damage armor, weapon systems, and physical strength. It is ideal for fighting gargoyles and operating in extremely hostile environments.

Note: A slightly scaled down version of the X-10A, the X-10 Predator, has been marketed abroad in the Americas (but not in Europe). The main differences are found in performance rather than appearance. Both look the same but the X-10A has increased armor protection, speed, strength and a better propulsion system. The X-10A has been in service with the NGR military for over 20 years and is a favorite among power armor pilots.

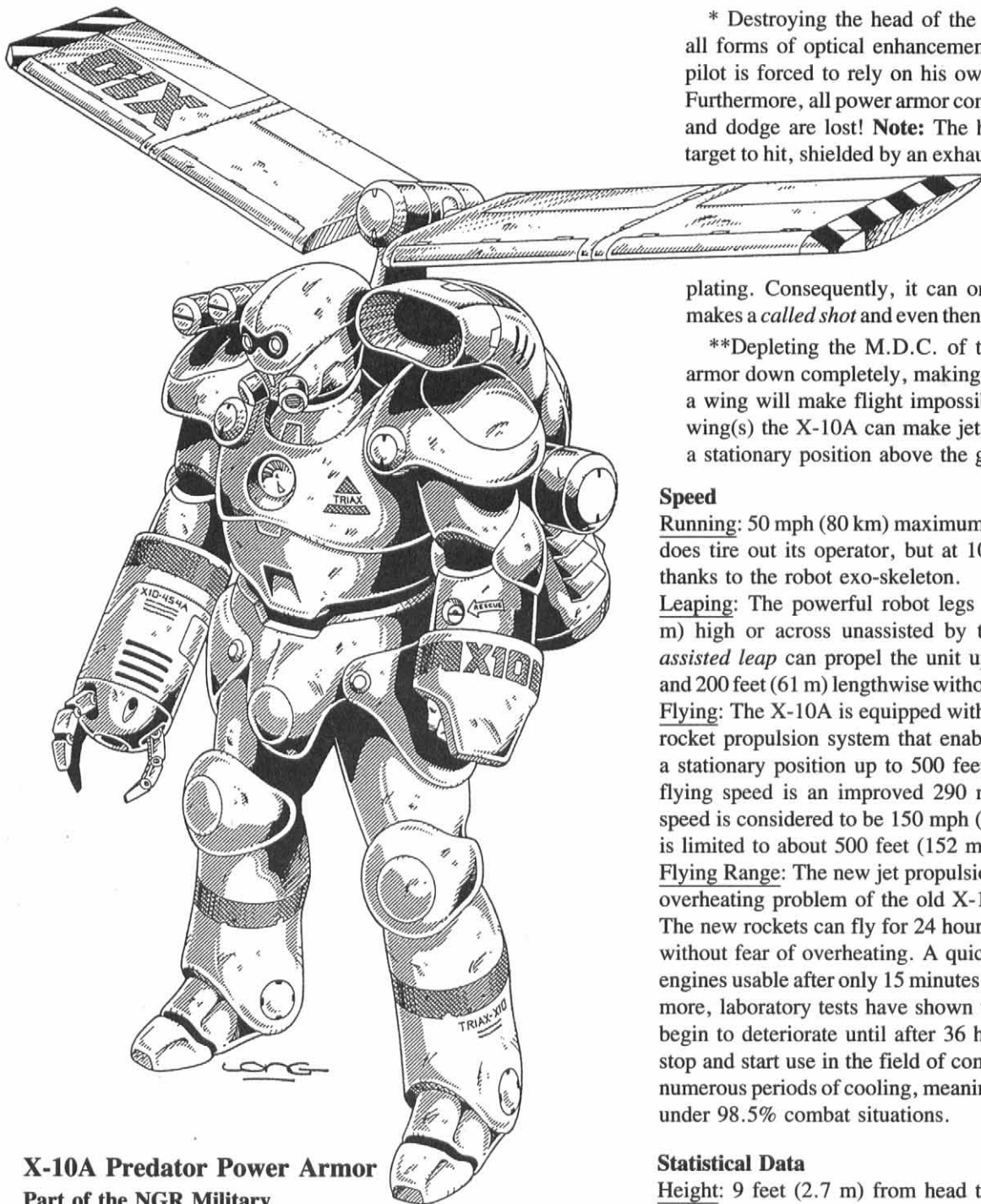

X-10A Predator Power Armor

Part of the NGR Military

German Name: der Raubtier (pronounced rowb teer)

Model Type: X-10A

Class: Strategic Armor Military Assault Suit

Crew: One

M.D.C. by Location:

- Shoulder Wings (2) — 50 each
- Main Rear Jets (2) — 80 each
- Lower Maneuvering Jets (2) — 30 each
- Right Hand & Forearm Pulse Cannon (1) — 100
- Mini-Missile Launcher (1, right shoulder) — 20
- Chest Headlight (1) — 2
- Left Forearm (1) — 80
- Shoulders & Upper Arm (2) — 150 each
- Legs (2) — 130 each
- *Head — 90
- **Main Body — 380

* Destroying the head of the power armor will eliminate all forms of optical enhancement and sensory systems. The pilot is forced to rely on his own human vision and senses. Furthermore, all power armor combat bonuses to strike, parry, and dodge are lost! **Note:** The head is a small and difficult target to hit, shielded by an exhaust tube, wings, and shoulder

plating. Consequently, it can only be hit when a character makes a *called shot* and even then the attacker is -4 to strike.

Depleting the M.D.C. of the main body will shut the armor down completely, making it useless. **Note: Destroying a wing will make flight impossible. However, even with no wing(s) the X-10A can make jet powered leaps and hover in a stationary position above the ground.

Speed

Running: 50 mph (80 km) maximum. Note that the act of running does tire out its operator, but at 10% of the usual fatigue rate thanks to the robot exo-skeleton.

Leaping: The powerful robot legs can leap up to 15 feet (4.6 m) high or across unassisted by the thrusters. A *jet thruster assisted leap* can propel the unit up to 100 feet (30.5 m) high and 200 feet (61 m) lengthwise without actually attaining flight.

Flying: The X-10A is equipped with a newer and more powerful rocket propulsion system that enables the Predator to hover in a stationary position up to 500 feet (152 m) or fly. Maximum flying speed is an improved 290 mph (464 km), but cruising speed is considered to be 150 mph (240 km). Maximum altitude is limited to about 500 feet (152 m).

Flying Range: The new jet propulsion system has eliminated the overheating problem of the old X-10 armor still sold overseas. The new rockets can fly for 24 hours, non-stop and at full speed without fear of overheating. A quick cooling system makes the engines usable after only 15 minutes of being shut down. Furthermore, laboratory tests have shown that the engines do not even begin to deteriorate until after 36 hours of constant flight. The stop and start use in the field of combat means the engines have numerous periods of cooling, meaning it can function indefinitely under 98.5% combat situations.

Statistical Data

Height: 9 feet (2.7 m) from head to toe, but 11 feet (3.35 m) with wings extended.

Width: Wings down: 5 feet (1.5 m)
Wings extended: 13 feet (4 m)

Length: 4 feet, 6 inches (1.4 m)

Weight: 1000 lbs (450 kg)

Physical Strength: Equal to a P.S. 40

Cargo: None

Power System: Nuclear, average energy life is 11 years.

Black Market Cost: The slightly weaker and slower X-10 Predator sells in the Americas for around 1.9 million credits in perfect condition. The X-10A is not available for mass market sale and is the exclusive property of the NGR military. The black market sells these rare acquisitions for 2.4 million in perfect condition. Rare; very poor availability.

Note: See **Rifts Sourcebook (One)** for full details regarding the X-10 Predator, the Coalition, and A.R.C.H.I.E.-3.

Weapon Systems

1. X-10-453A Pulse Cannon (1, right arm): This is a high-powered laser pulse cannon with unparalleled power. The weapon is hooked directly to the armor's nuclear power supply, eliminating the need for an external power pack.

Primary Purpose: Assault

Secondary Purpose: Defense

Weight: Built into the power armor.

Mega-Damage: 1D4 × 10 M.D. per multiple blast volley of four simultaneous energy pulses (counts as one melee attack/action) or can fire a single pulse inflicting 2D4 M.D.

Rate of Fire: Equal to number of combined hand to hand attacks (usually 4-6).

Maximum Effective Range: 4000 feet (1200 m)

Payload: Effectively unlimited.

2. Dual Shoulder Mini-Missile Launcher: A small mini-missile launcher holding two (2) mini-missiles is mounted above the right shoulder.

Primary Purpose: Anti-Aircraft

Secondary Purpose: Defense

Missile Type: Any mini-missile can be used, but standard issue is armor piercing (1D4 × 10 M.D.) or plasma (1D6 × 10). Fragmentation will be used for anti-personnel operations.

Mega-Damage: Varies with missile type.

Range: Usually about a mile.

Rate of Fire: One or two.

Payload: Two

3. Energy Rifles or Light Rail Gun and other hand-held weapons can be substituted in an emergency or used as a back-up weapon. Space limitations and the bulk of the armor limits additional weapons to one. The weapon can only be fired by the left hand, thus all right-handed pilots are -2 to strike.

4. Hand to Hand Combat: Rather than use a weapon, the pilot can engage in mega-damage hand to hand combat. See *Basic and Elite Power Armor Combat Training* in the Robot Combat section of **Rifts**, page 45. All abilities are the same except as follows:

- 1 to dodge penalty.

Normal Punch — 1D6 + 1 M.D.

Claw Punch — 2D4 M.D.

Claw Power Punch — 3D6 M.D.

Claw Crush or Tear — 1D6 + 1 M.D.

5. Sensor System Note:

1. The X-10A Predator has full optical systems, including laser targeting, telescopic, passive night vision (light amplification), thermo-imaging, infrared, ultraviolet, and polarization. It also has all the other features common to most power armor. Sensor Bonuses: +2 to strike is applicable to long-range weapon combat only, not hand to hand. See *Power Armor Combat Training* in the **Rifts RPG**, page 45, for other bonuses and details.

2. Distress Homing Beacon. All X-10A are equipped with a scrambled, radio homing signal used for extraction from combat zones. Before the gargoyles, brodkil and other monsters began to use modern equipment, the homing signal was completely undetectable by them. As they become increasingly familiar with high-tech equipment, the enemy has a 30% chance of tracing the signal.

X-60 Flanker Urban Defender

Police and Riot Control

The X-60 Flanker is specifically designed for riot control and urban combat. As such, it is the mainstay of NGR police forces and civil defense. The Flanker is a hybrid power armor suit that is, on one hand, clearly a giant exoskeleton and, on the other, a one-man robot. The Flanker is unique in many respects. First and foremost, a pilot can be suited up and activate the power armor in less than 15 seconds (one melee round)! Most other types of power armor requires one to three minutes to suit up and "get mobile." This also means the Flanker's operator can exit and reenter the armor with equal ease. This can be very useful during investigations and arrests. Second, the Flanker is extremely easy to operate. Third, it is faster and more agile than it looks (always an advantage on the field of battle). Lastly, it has an array of concealed weapons. The hidden weapons make the machine more formidable than it appears and offers a nice range of urban combat tactics. Additionally, many of the urban combat features meant to disperse crowds, control situations, counter terrorists, and capture criminals, can be easily substituted with front-line infantry weapons. For example, tear gas and smoke missiles can be substituted for explosive missiles.

The X-60 Flanker has performed admirably as an effective crime fighting, anti-terrorist and riot control tool. A pair of Flankers may be assigned to patrol trouble areas and city streets, disperse gangs, break up angry crowds, hunt invading monsters, capture criminals, and to protect and help the citizens of the New German Republic. They break up illegal MOM shops, body chop-shops, round up illegal aliens and escort D-bee refugees beyond the NGR's border. Flankers may be assigned to escort prisoners or visiting dignitaries, and to guard security zones such as police headquarters, prisons, civil defense shelters, hospitals, Triax compounds and other industrial, military and civilian locations of strategic or humanitarian importance. On military bases, the Flanker is used in a similar capacity as well as a cargo hauler. Infantry field units assist in defense, rescue/retrieval of downed robots and personnel, repairs of bots and vehicles and are assigned to guard duty and military police. Military Flankers are usually armed with anti-armor and/or anti-personnel missiles and carry a TX-41 laser pulse rifle or rail gun for additional firepower.

X-60 Flanker Power Armor

Part of the NGR Military & Police Force

German Name: der Flankierer (pronounced Flon keer er)

Model Type: PA-X-60

Class: Strategic Armor Urban & Military Assault Suit

Crew: One

M.D.C. by Location:

Shoulder (2) — 50 each

Rear Cooling Tube (2) — 80 each

Hydraulic Hand Extensions (2) — 35 each

Hands (2) — 40 each

Lower Arms with Plate (2) — 100 each

Legs (2) — 120 each

Feet (2) — 50 each

Mini-Missile Launchers (2, lower leg) — 30 each

Chest Viewing Portal (1) — 15

Spotlight (1, top of head) — 3

Shoulder Lights (2) — 2 each

Leg Lights (2) — 2 each **Main Body — 380
*Sensor Head — 90

* Destroying the head of the power armor will eliminate all forms of optical enhancement and sensory systems. The pilot is forced to rely on his own human vision and senses. Furthermore, all power armor combat bonuses to strike, parry, and dodge are lost! **Note:** The head is a small and difficult target to hit. Consequently, it can only be hit when a character makes a *called shot* and even then the attacker is -3 to strike. The same is true of trying to shoot the mini-missile launchers, lights, and hands.

**Depleting the M.D.C. of the main body will shut the armor down completely, making it useless.

Note: The Flanker has three vulnerable areas where portions of the pilot's body are exposed. This is why the power armor operator should ALWAYS wear mega-damage body armor.

1. The arms: An attacker must make a called shot and even then is -4 to strike.
2. The upper legs: An attacker must make a called shot and even then is -5 to strike.
3. The Viewing Portal: An attacker must make a called shot and even then is -6 to strike; it is a tiny target.

Speed

Running: 50 mph (80 km) maximum. Note that the act of running does tire out its operator, but at 20% of the usual fatigue rate thanks to the robot exo-skeleton.

Leaping: The robot legs can leap up to 10 feet (3 m) high or 15 feet across (4.6 m) from a running start.

Flying: None

Statistical Data

Height: 11 feet (3.3 m) from head to toe.

Width: 5 feet (1.5 m)

Length: 4 feet (1.2 m), including the cooling pylon.

Weight: 1000 lbs (450 kg)

Physical Strength: Equal to a P.S. 30

Cargo: None

Power System: Nuclear, average energy life is 11 years.

Black Market Cost: 500,000 credits in perfect condition and fully loaded. Very poor availability. Not offered by Triax in the mass market.

Weapon Systems

1. **Extendable Hydraulic Hands/Arms:** The hands are connected to a hydraulic system similar to those once used by remote control robots and medical bots. The simple hand controlled levers operated by the pilot can extend the robot's reach by six feet (1.2 m; for a total reach of 13 feet/3.63 m), giving new meaning to the phrase, "the long arm of the law." Many a troublemaker about to leap over a high fence or from a rooftop has been surprised by the whistle of hydraulics in his ears and the feel a large mechanical hand grabbing him by his leg or shirt collar. The extendable hands/arms also enables the X-60 operator to reach into narrow places like storm drains, ventilator shafts, tunnels, cavities, holes, into crates or even under a bed. All places that a man or bot may not be able to reach, or able to reach without exposing himself to attack.
2. **Riot Baton Launchers (2):** Beneath the large identification number plates on each of the forearms is a concealed, rapid-

fire riot control baton launcher. The device fires rubber batons or bullets about six inches long (.15 m) that hurt, knock down or stun human targets. The idea behind such a stinging assault is to jar the person and hopefully stop what he/she was doing and surrender or run away without further violent incident.

Primary Purpose: Assault

Mega-Damage: 1D4 S.D.C. plus the impact of the baton has a 50% chance of knocking a character off his feet. Roll percentile dice. A roll of 01-50 means the target is knocked off his feet, loses initiative and one melee attack/action. A "called shot" and a successful roll to strike can be used to knock a weapon out of a character's hand (not applicable against robots, cyborgs or supernaturally strong characters). The same striking blow has a 01-25% chance of stunning the character for 1D4 melee rounds (15 to 60 seconds).

Rate of Fire: One equal to the number of combined hand to hand attacks of the X-60's pilot (usually 4-6). Or a short volley of two to eight shots at the same target. **Note:** Each additional baton fired in a volley adds 10% to the likelihood of knocking a character off his feet and stunning him.

Maximum Effective Range: 400 feet (120 m)

Payload: 64 total; 32 in each arm.

3. **Flip-Top Shoulder Canister Launchers (2):** The armored plates above the shoulders flip up to launch smoke and/or stun/flash grenades.

Primary Purpose: Close range anti-personnel and riot control.

Grenade Type: Canister style grenades — no mega-damage.

Stun/flash grenades are designed to disorient and confuse terrorists or criminals who are holding hostages in confined places. The grenade makes a loud exploding boom and emits a bright flash followed by a shower of white-hot sparklets and some white smoke. The flash, burning sparks and smoke should blind and startle any character without environmental armor and shielded visor. Victims of the stun/flash grenade are -8 to strike, parry and dodge, -1 on initiative and lose one melee attack/action for the next 1D4 melee rounds (15 to 60 seconds). Even those in armor should be momentarily distracted for 1D4 seconds and lose initiative.

Smoke grenades release a thick cloud of smoke that covers a 20 foot (6 m) radius. The smoke obscures vision in and through the cloud from those on the outside of it. Infrared cannot penetrate a smoke cloud or be used inside a smoke cloud. Those inside the cloud will be blinded and have trouble breathing while inside it. Those who are not protected by environmental suits or gas mask and goggles will be -5 to strike, parry and dodge and -1 on initiative. Attackers firing into/through the cloud are shooting wild. Note that passive nightscopes will work in a smoke cloud.

Fragmentation grenades can be substituted (2D6 M.D. with a 20 foot blast radius).

Mega-Damage: Varies with grenade type.

Range: 25 to 150 feet (7.6 to 46 m).

Rate of Fire: One at a time or a volley of two or four.

Payload: A total of 16; eight in each shoulder.

4. **Dual Leg Mini-Missile Launchers (2):** The compartments on the lower legs flip open to release tear gas mini-missiles.

Primary Purpose: Anti-Personnel and anti-riot

Missile Type: Tear gas: The gas will instantly affect all characters without gas masks or environmental body armor. The eyes burn, sting and water profusely, causing great discomfort and makes

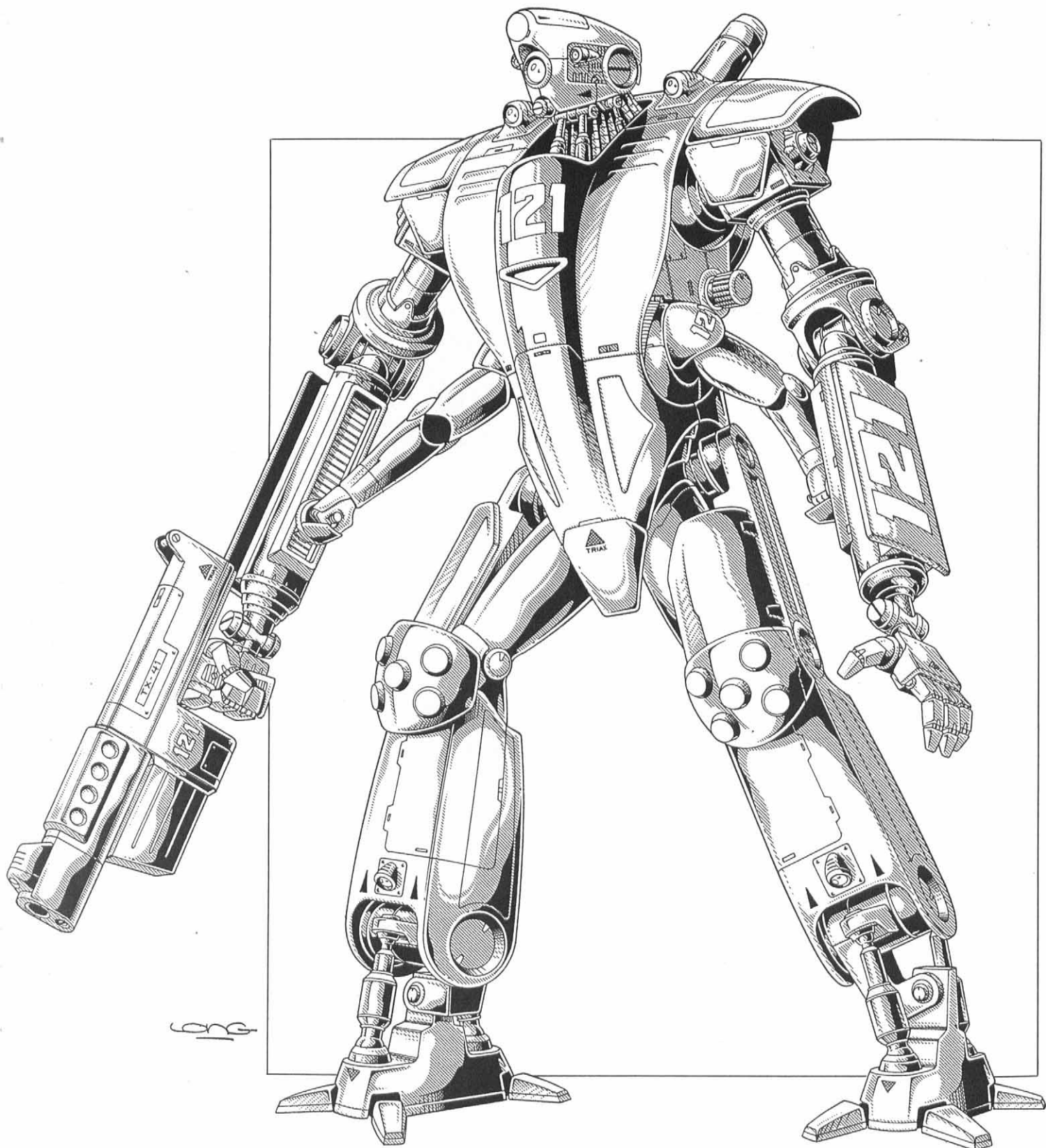

seeing clearly impossible. The gas also makes breathing difficult and irritates exposed skin. The effects last for 3D4 minutes. The 25 foot (7.6 m) cloud dissipates in about five minutes unless blown away by wind in 1D4 minutes. Victims of tear gas are -10 to strike, parry and dodge, -3 on initiative and lose one melee attack/action for each of the next 1D6 + 1 melee rounds. Those in environmental armor are completely unaffected.

Smoke missiles can be used instead or as part of the payload.

Any of the explosive mini-missiles can be substituted for infantry combat.

Mega-Damage: Varies with missile type.

Range: Tear gas missiles: 4000 feet (1200 m) maximum.

Rate of Fire: One at a time or a volley of two or four.

Payload: Total of 16; eight in each leg.

5. Energy Rifle, Light Rail Gun or other hand-held weapons can be also be carried and used by the X-60 Flanker. The TX-41 is standard issue for infantry units.

6. Hand to Hand Combat: Rather than use a weapon, the pilot can engage in mega-damage hand to hand combat. See *Basic and Elite Power Armor Combat Training* in the Robot Combat section of *Rifts*, page 45. All abilities are the same except as follows:

Restrained Punch — 4D6 + 15 S.D.C.

Full Strength Punch — 1D6 M.D.

Power Punch is not available

Crush or Tear — 1D4 M.D.

Body Flip — 1D4 M.D.

7. Sensor System Note: 1. The Flanker has full optical systems including laser targeting, telescopic, passive night vision (light amplification), thermo-imaging, infrared, ultraviolet, and polarization. It also has all the other features common to most power armor. **Sensor Bonuses:** +1 to strike, +1 to dodge, +2 to parry in close range and hand to hand combat. It is also a capable climber with an equivalent climb skill of 70%/60%. See *Power Armor Combat Training* in the *Rifts RPG*, page 45, for other bonuses and details.

2. Long- and short-range radio broadcasting and scanning capabilities as well as a distress/homing beacon.

Triax X-500 Forager Battlebot

The Forager is an old style assault robot known for its dependability and firepower. It has been in service for 50 years and is only now being phased out of service (replaced by the DynaMax and Jager series of bots). It is excellent for travel over all types of land terrain from swamps or forests to low mountains. It is suitable for reconnaissance, defense and combat. The X-500 can also be used in construction and mining operations. It is currently being marketed overseas and the NGR has just authorized its sale to the mass market in Europe as well. Wilderness scouts and adventurers find the Forager very attractive.

X-500 Forager Battlebot

Part of the NGR Military

German Name: der Furagierer (pronounced: foo rog ear er)

Model Type: X-500

Class: Ground Infantry Assault Robot with multiple capabilities.

Crew: Two, a pilot and co-pilot. It can also accommodate two passengers.

M.D.C. by Location:

Medium Range Missile Launchers (2) — 130 each

Belly Gun Turret (1) — 100

Hands (2) — 60 each

Forearms (2) — 100 each

Upper arms (2) — 140 each

Legs (2) — 200 each

Spotlight (1, head area) — 10

Small Headlights (2, shoulder area) — 5 each

*Head Sensors (1; small circle) — 70

**Main Body — 350

Reinforced Pilot's Compartment — 100

* Destroying the sensor head of the bot will eliminate all forms of optical enhancement and sensory systems. The pilot must then rely on his own human vision and senses without

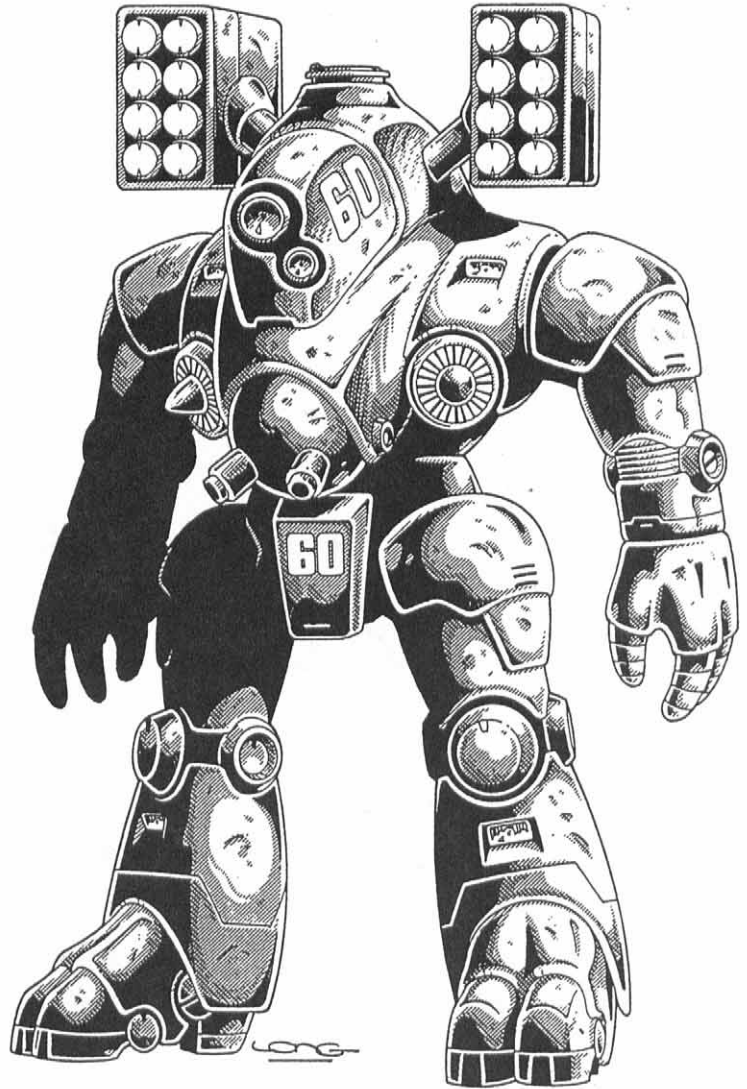

bonuses to strike, parry, and dodge from the bot. **Note:** The sensors are located in the small, flat disk on the top of the head. It is a difficult target to hit and can only be struck when a character makes a *called shot*, and even then the attacker is -4 to strike.

**Depleting the M.D.C. of the main body will shut the armor down completely, making it useless.

Speed

Running: 60 mph (96 km) maximum. Note that the act of running does NOT tire out its operator. Cruising speed is usually a cautious 35 mph (56 km). The bot is well suited for most terrains, including underwater. It is not as well suited for climbing rope/cables or steep mountains. It is excellent for mining (digging) and construction operations.

Leaping: 10 feet high or across from a stationary position; 20 feet (6 m) high or 30 feet (9 m) lengthwise from a running start.

Flying: Not possible.

Statistical Data

Height: 29 feet, 5 inches (9 m)

Width: 15 feet (4.6 m)

Length: 12 feet (3.7 m)

Weight: 28 tons fully loaded, 22 tons without missiles and launchers.

Physical Strength: Equal to a P.S. 40

Cargo: Small area for the pilot's personal items, as well as a weapon bin that has room for four rifles, four pistols, four suits of body armor, a dozen fragmentation grenades, four canteens and four containers of food rations (4 week supply). A small refrigeration unit and 100 gallon (378.5 liter) water cooler is built into the robot.

Power System: Nuclear, average energy life is 20 years.

Black Market Cost: 22 million credits for a new, undamaged, full combat unit, complete with missiles. Fair availability. 13 million for the labor and exploration models which do not have the missiles or missile launchers (has belly gun).

Weapon Systems

1. Dual Shoulder, Medium Range Missile Launchers (2):

Eight medium range missiles are housed in a launcher above each shoulder. Both launchers are capable of 180 degree upward rotation.

Primary Purpose: Anti-Armor

Secondary Purpose: Anti-Aircraft

Missile Type: Any medium range missile can be used, but standard military issue is armor piercing (2D4×10 M.D.; multi-warhead whenever possible) or plasma (2D6×10). Fragmentation may be used for anti-personnel operations.

Mega-Damage: Varies with missile type.

Range: Usually about 40+ miles (64+ km).

Rate of Fire: One at a time or in volleys of two or four.

Payload: 16 missiles; eight in each launcher.

2. Ion Belly Gun Turret: The double-barreled ion blaster is designed to counter ground troops and can rotate 90 degrees in all directions. The turret can fire one of its guns or both simultaneously. Also note that the entire upper torso section of the X-500 Forager can rotate 360 degrees, which means it can turn completely around without having to move its feet!

Primary Purpose: Assault

Secondary Purpose: Defense

Mega-Damage: 4D6 M.D. per single blast or 1D4×10 per dual simultaneous blast.

Rate of Fire: Equal to number of combined hand to hand attacks (usually 4-6).

Maximum Effective Range: 4000 feet (1200 m)

Payload: Effectively unlimited.

3. Hand to Hand Combat: Rather than use a weapon, the pilot can engage in mega-damage hand to hand combat. See *Basic and specific Robot Combat Training* in the **Rifts RPG**, pages 44 and 45. All abilities are the same as the UAR-1 Enforcer except as follows:

Crush, Pry or Tear: 2D4 M.D.

Dig: 2D6 M.D.

Stomp: 2D4 M.D.

4. Sensor System Note: The X-500 Forager has full optical systems, including laser targeting, telescopic, passive night vision (light amplification), thermo-imaging, infrared, ultraviolet, and polarization. Plus all other features common to most robots. Commercial versions do not have the thermo-imaging or ultraviolet systems.

Triax X-535 Hunter

More commonly known as the "Jager"

The Jager is one of the NGR infantry's favorite robot work-horses. The robot has been in service for the last nine years and has proven itself innumerable times under every conceivable field condition. The one-man bot is designed to be an incredibly fast and nimble, all-purpose infantry weapon. The basic model is armed only with its head machineguns and one or two hand-held rail guns. The rail gun can be fitted with a short clip or belt feed drum. An additional ammunition belt containing extra ammo-clips and hand grenades can be hung around the waist or slung over the chest. The Jager can leap, climb, tumble and roll at great speed and with surprising grace. The basic unit is superb for reconnaissance and infantry charges.

The Jager can also be turned into a walking artillery unit or anti-aircraft weapon. This is made possible by mounting any one of three different long range, heavy cannon on the robot's shoulder. Each shoulder has the Triax TX-481M Universal Mount. A giant robot or crane hoists one of the weapon systems onto the shoulders of the X-535 and the cannon snaps snugly and firmly in place. The big guns are more mobile on the Jager than most conventional vehicles. However, the TX-884I and the TX-862FC reduce the Jager's speed by 50% and combat bonuses to parry, dodge and roll by half. The powerful TX-843P is less bulky and only reduces the Jager's speed and bonuses by one quarter.

Note: The Hunter is a favorite among power armor commandos, intelligence operatives and robot combat pilots. Approximately 25% of the Army's combat robots are the X-535 Jager/Hunter!

X-535 Hunter

Exclusive to the NGR Military

German Name: der Jaeger (pronounced Yae ger)

Model Type: X-535

Class: Ground Infantry Assault Robot with multiple weapon systems.

Crew: One pilot

M.D.C. by Location:

Hands (2) — 50 each

Forearms (2) — 70 each

Upper arms (2) — 120 each

Legs (2) — 120 each

Feet (2) — 80 each

Headlights (2, chest) — 5 each

TX-250 Rail Gun (1 or 2) — 100

Pilot View Port (1) — 25

Optional: TX-843P Particle Beam Cannon — 170

Optional: TX-862FC Anti-Aircraft Cannon — 210

Optional: TX-871MM Missile Drum — 200

Optional: TX-884I Ion Cannon — 290

*Head & Sensors (1) — 75

**Main Body — 300

Reinforced Pilot's Compartment — 80

* Destroying the sensor head of the bot will eliminate all forms of optical enhancement and sensory systems. The pilot must then rely on his own human vision and senses without bonuses to strike, parry, and dodge from the bot. It is a difficult target to hit and can only be struck when a character

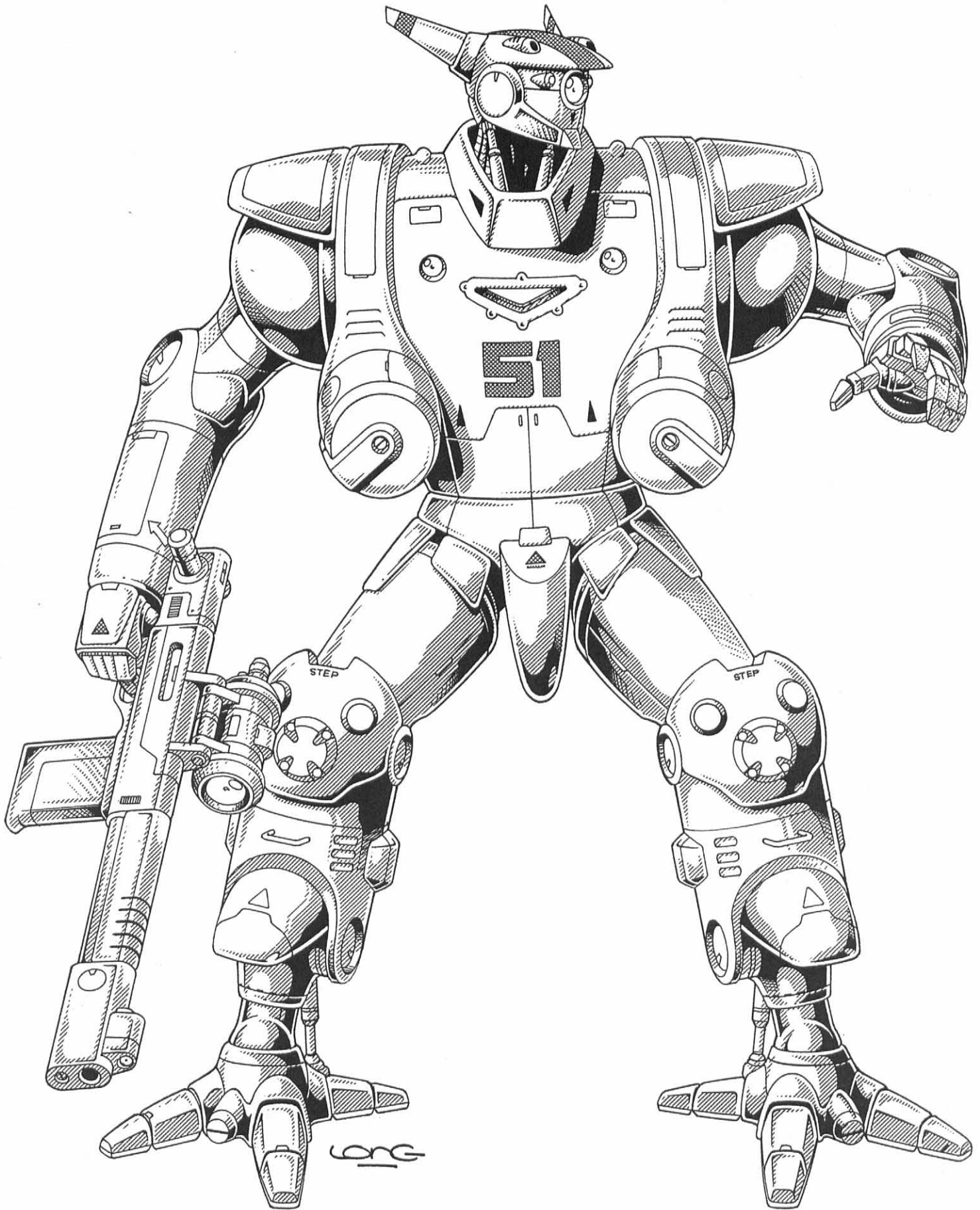

makes a *called shot*, and even then the attacker is -4 to strike. The same penalty applies to striking the hands and feet. The view port in the chest also requires an attacker to make a called shot and is -9 to strike.

**Depleting the M.D.C. of the main body will shut the armor down completely, making it useless.

Speed

Running: 140 mph (224 km) maximum. Note that the act of running does NOT tire out its operator. Cruising speed is usually around 60 mph (96 km). The bot is well suited for most terrains, including underwater. It is also superb at climbing rope/cables and the sheer side of mountain cliffs and buildings. The toes are semi-prehensile and can be bent to dig into and cling onto footholds. The Jager is also suitable for labor, mining and construction.

Leaping: 30 feet (9 m) high or lengthwise from a stationary position; 40 feet (12 m) high or 60 feet (18.3 m) lengthwise from a running start.

Flying: Not possible.

Statistical Data

Height: 12 feet (3.6 m) as a basic combat unit. Add five feet (1.5 m) from cannon attachments for a total height of 17 feet (5 m) when they are in use.

Width: 5 feet (1.5 m)

Length: 5 feet (1.5 m)

Weight: 3 tons as a basic unit. 6 to 9 tons fully loaded with cannons and launchers.

Physical Strength: Equal to a P.S. 40

Cargo: Small area for the pilot's personal items.

Power System: Nuclear, average energy life is 15 years.

Black Market Cost: 12 million credits for a new, undamaged basic unit with rail gun. Add 8 million for each of the heavy, long-range weapon systems.

Weapon Systems

1. TX-250 Maxi-Rail Gun (1 or 2): This is the standard weapon for the X-535 Hunter/Jager. The weapon is light enough that the 12 foot (3.6 m) robot can use one in both hands, although one is standard issue; two require authorization. The TX-250 rail gun can use what is called a short clip with 300 rounds (10 bursts) or a belt feed drum containing 3000 rounds (100 bursts). One of the unique features of the TX-250 is that it has three damage settings. It can fire one bullet, a 15 round short burst, or a maximum damage burst of 30 rounds. Few rail guns are as versatile. If two rail guns are used, one in each hand, only one can be connected to an ammo drum. Other rail guns can be substituted.

Primary Purpose: Assault

Secondary Purpose: Defense

Weight: Gun: 250 lbs (112.5 kg). One TX-250 Ammo-Drum is another 250 lbs (112 kg). The ammo-drum hooks to the back of the bot.

Mega-Damage: A full damage burst fires 30 rounds and inflicts 6D6 M.D. A short burst of 15 rounds does 3D6 M.D. and a single round does 1D4 M.D.

Rate of Fire: Equal to number of combined hand to hand attacks (usually 4-8).

Maximum Effective Range: 6000 feet (1828 m)

Payload: The short clip holds 300 rounds and is capable of firing 10 full damage bursts (30 rounds) or half damage short bursts (15 rounds).

The 3000 round drum is capable of firing 100 full damage bursts or 200 half damage bursts (15 rounds). Reloading a drum will take about three minutes for those not trained, but a mere one minute by somebody trained in the use of power armor. A strength of 28 or higher is required to handle the drum.

Special TX-250 Feature: 1) The rail gun has its own laser targeting and radar tracking system built into the weapon itself (the large round cylinder). This can be especially useful if the sensor head is destroyed. Range: 6000 feet (1828 m). Bonuses: +1 to strike, +1 to parry and dodge.

2. Head Guns (2): On the top of the Jager's head are two tiny ports that are rapid-fire guns. They are used primarily against D-bee refugees and non-mega-damage foes. The real bullets can be replaced with rubber ones for riot control.

Primary Purpose: Riot control

Weight: None; they are a part of the robot.

Mega-Damage: A full damage burst fires 30 rounds and inflicts 6D6 S.D.C., a short burst of 15 rounds does 3D6 S.D.C.; a single round cannot be fired.

Rate of Fire: Equal to number of combined hand to hand attacks (usually 4-8).

Maximum Effective Range: 2000 feet (610 m)

Payload: 2000 rounds capable of firing 66 full damage bursts or 133 half damage bursts (15 rounds). Reloading a drum will take about five minutes for those not trained or two minutes by field mechanics. A strength of 20 or higher is required to handle the replaceable ammo drum concealed inside the head.

3. Forearm Mini-Missile Launchers (2): Located in each forearm are concealed mini-missile launchers.

Primary Purpose: Anti-Aircraft

Secondary Purpose: Ant-Personnel

Missile Type: Any mini-missile can be used, but standard issue is armor piercing (1D4 x 10 M.D.) or plasma (1D6 x 10). Fragmentation and/or tear gas may be used for anti-personnel operations.

Mega-Damage: Varies with missile type.

Range: Usually about a mile.

Rate of Fire: One or two.

Payload: Six total; three in each arm.

4. TX-843P Interchangeable Particle Beam Cannon (1): This is a comparatively short range, anti-armor infantry weapon that can be mounted on the shoulders of the Jager to give it extra firepower. It is used primarily in troop assaults. The addition of the big gun reduces the X-535 Hunter's speed and combat bonuses by 25%. The cannon can be aimed up or down 80 degrees.

Primary Purpose: Anti-Armor

Secondary Purpose: Defense

Weight: Three tons, but comes with its own energy supply.

Mega-Damage: 2D4 x 10 M.D. per single blast!

Rate of Fire: Equal to number of combined hand to hand attacks (usually 4-8).

Maximum Effective Range: 3000 feet (914 m)

Payload: Effectively unlimited.

Special Feature: Independent power supply.

TX-843P PARTICLE BEAM CANNON

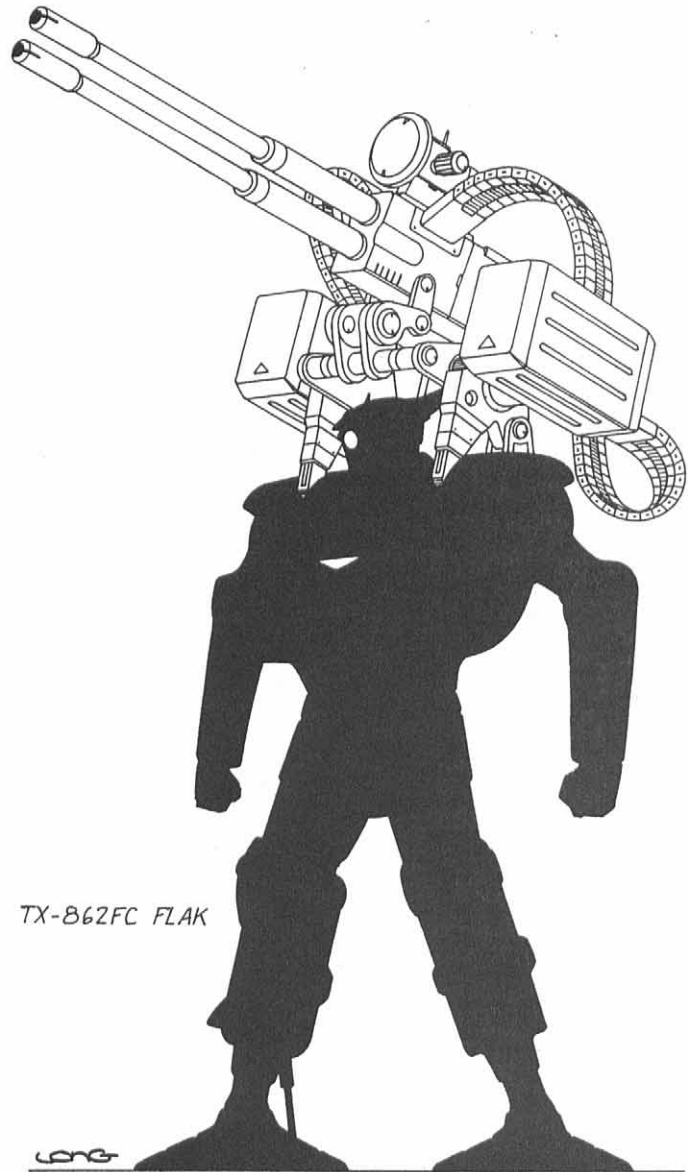
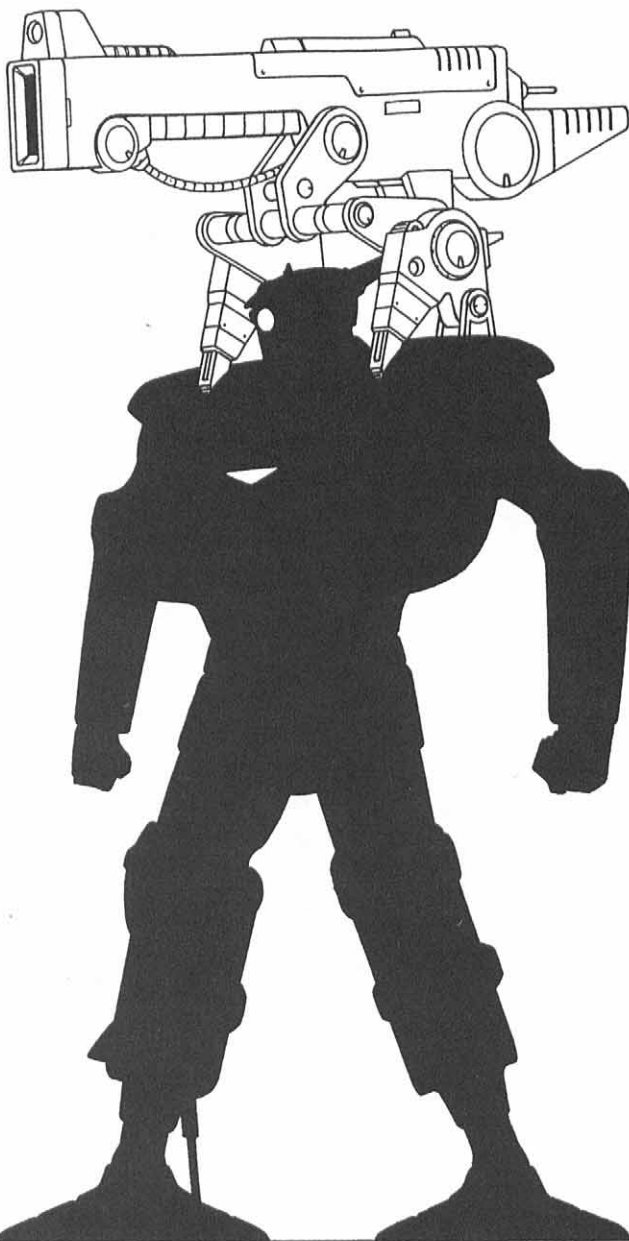

TX-862FC FLAK

5. TX-862FC Interchangeable, Recoilless, Anti-Aircraft Flak Gun (1):

This double-barreled, rapid-fire cannon shoots explosive rounds used against flying enemies. It is a long-range infantry support and defense weapon that can be mounted on the shoulders of the Jager to give it extra firepower. The addition of the big gun reduces the X-535 Hunter's speed and combat bonuses by 50%. The flak cannon can be aimed up or down 80 degrees.

Primary Purpose: Anti-Aircraft/Gargoyles

Secondary Purpose: Defense

Weight: 4.5 tons, but comes with its own energy supply.

Mega-Damage: Single round 4D6 M.D., two rounds 1D6 × 10 M.D., or a rapid fire volley of six rounds 3D6 × 10 M.D.

Rate of Fire: Equal to number of combined hand to hand attacks (usually 4-8).

Maximum Effective Range: 10,000 feet (3048 m)!

Payload: Total 800; 400 rounds in each giant ammo-drum. That's 133 rapid fire volleys of six rounds or 400 two round volleys.

Special Feature: The flak cannon has an independent power supply and its own laser targeting and radar tracking system (the large round cylinder on top). The secondary sensor system can be especially useful if the sensor head of the bot is destroyed. The secondary sensor array also enables the big gun to track and automatically fire two round volleys at aerial targets while the pilot concentrates on enemy ground troops. Sensor Range: 11,000 feet (3353 m). Bonus: + 1 to strike when set on automatic aerial attack, or + 2 to strike when fired by the pilot.

6. TX-884I Interchangeable Ion Cannon & Missile Launcher:

The big cannon fires devastating ion blasts. Six medium range missiles are housed in a launcher above each shoulder. Both launchers are capable of 180 degree upward rotation.

Primary Purpose: Anti-Armor

Secondary Purpose: Anti-Aircraft

Missile Type: Any medium range missile can be used, but standard military issue is armor piercing (2D4 × 10 M.D.; multi-warhead whenever possible) or plasma (2D6 × 10). Fragmentation may be used for anti-personnel operations.

Missile Rate of Fire: One at a time or in volleys of two or four.

Missile Payload: 12 missiles total; six in each launcher.

Missile Range: Usually about 40+ miles (64+ km).

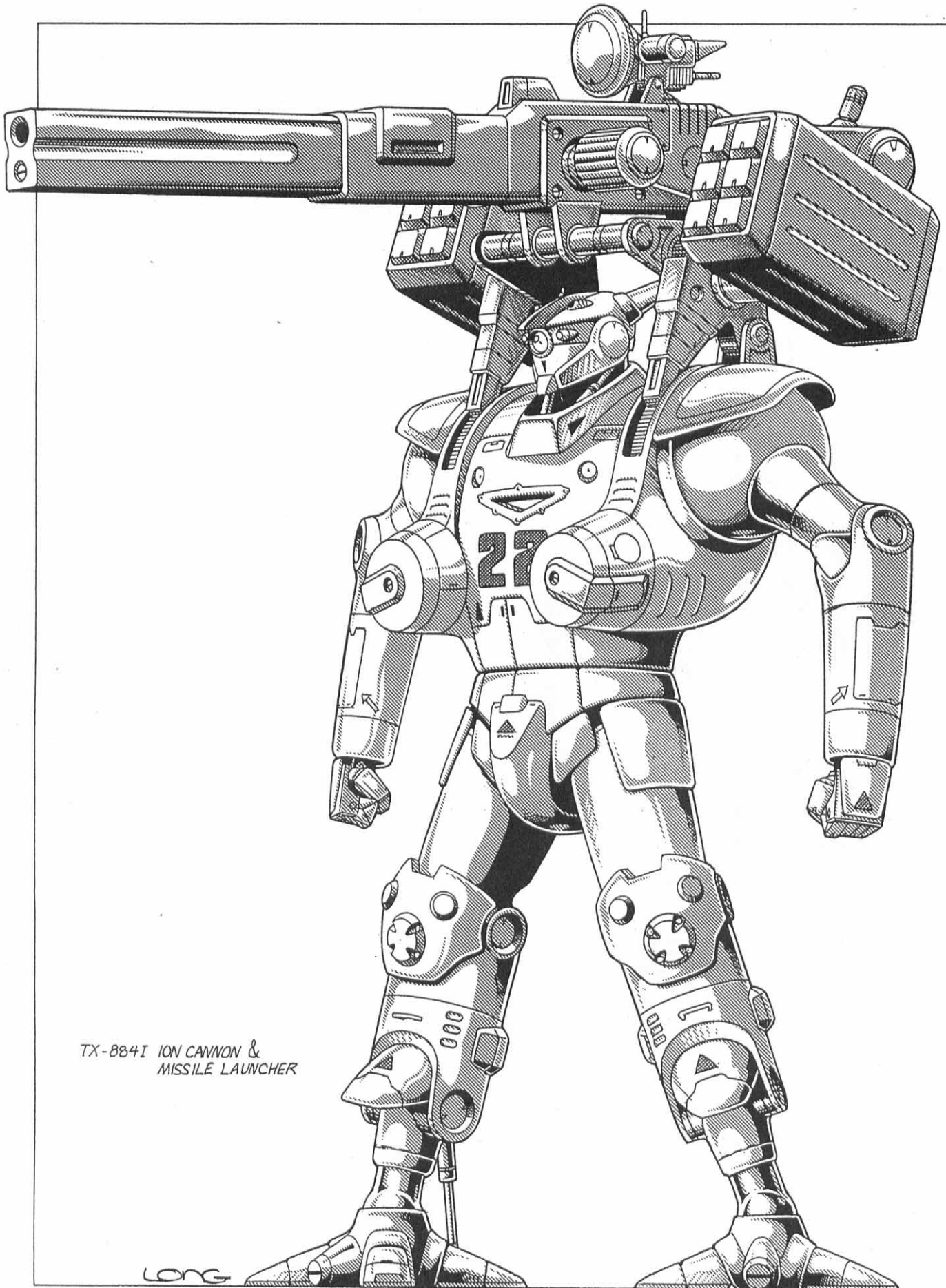

*TX-884I ION CANNON &
MISSILE LAUNCHER*

LONG

Mega-Damage of Ion Cannon: 1D6 × 10 per blast
Cannon Maximum Effective Range: 4000 feet (1200 m)
Cannon Rate of Fire: Equal to number of combined hand to hand attacks (usually 4-8).
Cannon Payload: Effectively unlimited.
Special Feature: The cannon has its own laser targeting and radar tracking system built into the weapon itself (the large round cylinder on top). This can be especially useful if the sensor head is destroyed or it can track targets independent of the Jager's sensor head. Range: 6000 feet (1828 m). Bonus: + 1 to strike.
Overall Weight: 6 tons

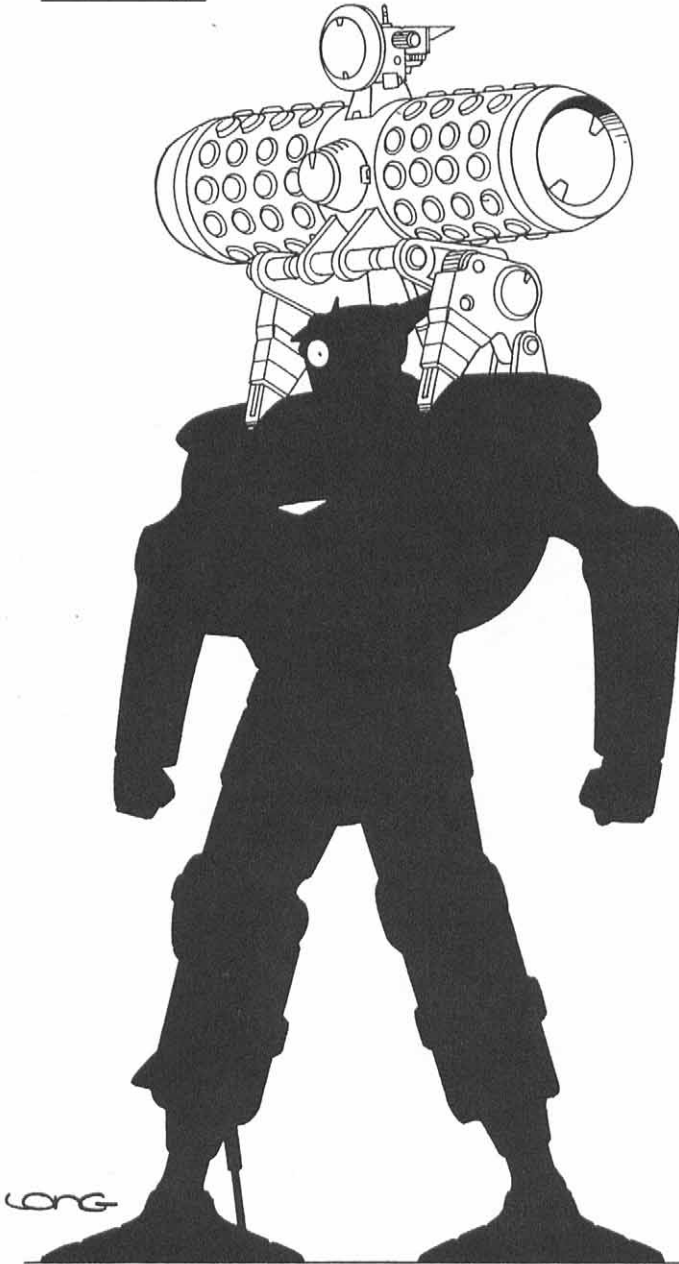

7. TX-871MM Interchangeable Rotary Missile Drum Launchers (2): Six medium range missiles are housed in a launcher above each shoulder. Both launchers are capable of 180 degree upward rotation.

Primary Purpose: Anti-Armor

Secondary Purpose: Anti-Aircraft

Missile Type: Any short range missile can be used, but standard military issue is armor piercing (1D6 × 10 M.D.) or plasma (1D6 × 10 M.D.). Fragmentation and others may be used for

anti-personnel operations. A typical combat mix is 48 armor piercing, 40 plasma, 4 fragmentation and 4 smoke.

Missile Rate of Fire: One at a time or in volleys of 2, 4, 8, 16, 32 or 48.

Missile Range: Armor Piercing: 5 miles (8 km), Plasma: 3 miles (4.8 km).

Missile Payload: 96 short-range missiles total! 48 in each launcher.

Overall Weight: 6 tons

Special Feature: The rotary missile drum has its own laser tracking, radar, targeting, communications and all the sensor systems standard to robots. This can be especially useful if the sensor head is destroyed or it can track targets independent of the Jager's sensor head. Range: 6000 feet (1828 m). Missile Bonus: + 2 to strike.

8. Hand to Hand Combat: Rather than use a weapon, the pilot can engage in mega-damage hand to hand combat. The speed of the X-535 Hunter gives it a different range of damage and bonuses than those listed in the **Rifts RPG**.

Bonuses & Damage from X-535 Hunter/Jager Combat Training

Restrained Punch — 1D6 × 10 S.D.C.

Full Strength Punch — 1D6 M.D.

Power Punch — 2D6 M.D. (counts as two attacks)

Crush, Pry or Tear: 1D4 M.D.

Kick — 1D6 M.D.

Leap Kick — 2D6 M.D. (counts as two attacks)

Power Leap Kick — 3D6 M.D. (running start, counts as 2 attacks)

Body Flip/Throw — 1D4 M.D.

+ 2 to strike

+ 4 to parry

+ 3 to dodge

+ 4 to roll with impact

+ 4 to pull punch

+ 10% to climb

+ 1 melee action/attack at levels 1, 2, 4, 7, 10 and 14!

9. Sensor System Note: The X-535 Jager has full optical systems, including laser targeting, telescopic, passive night vision (light amplification), thermo-imaging, infrared, ultraviolet, and polarization. Plus all other features common to most robots.

Triax X-545 Super Hunter

More commonly known as the "Armored Jager"

The Armored Jager or Super Hunter is a larger, much more heavily armored version of the Jager infantry robot. The robot has been in service for the last six years and has proven itself to be as reliable as its smaller, faster brother. The one-man bot is designed to be a quick and powerful infantry defense weapon. It is the Super Hunter that will stand its ground to fight advancing enemy troops while NGR troops retreat or reposition themselves. The Super Hunter has both anti-personnel and anti-armor weapon systems.

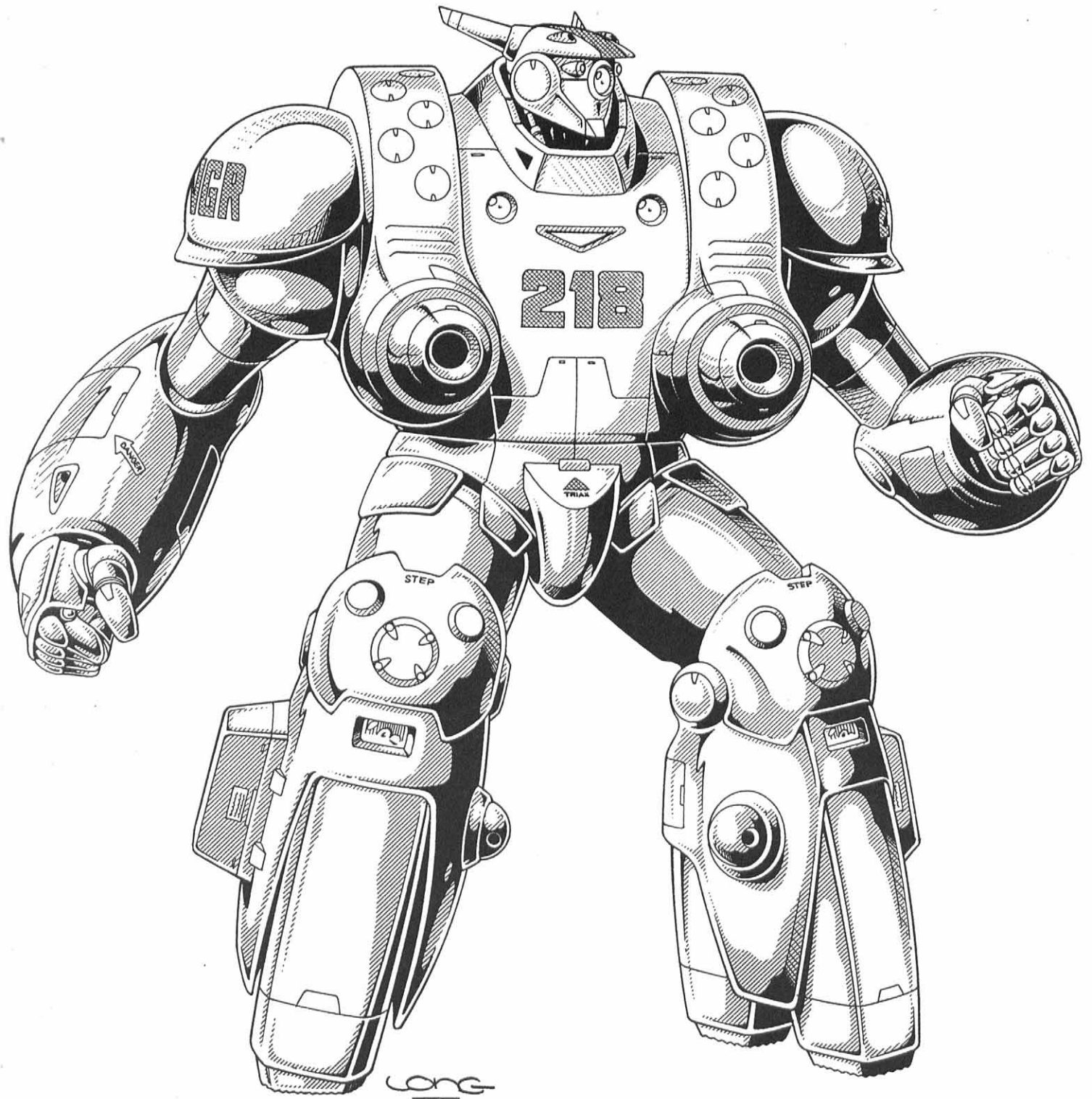

X-545 Super Hunter/Armored Jager

Exclusive to the NGR Military

German Name: der Ueberjaeger
(pronounced: oo burr yae ger)

Model Type: X-545

Class: Ground Infantry Assault Robot with multiple weapon systems.

Crew: One pilot

M.D.C. by Location:

Ion Cannon (2; chest) — 150 each

Hands (2) — 90 each

Forearms (2) — 150 each

Forearm Vibro-Swords (2) — 50 each

TX-250 Rail Gun (1) — 100

Upper arms (2) — 130 each

Shoulder Mini-Missile Launchers (2) — 100 each

Legs (2) — 200 each

Feet (2) — 150 each

Leg Missile Launchers (2) — 50 each

Leg Flamethrowers (2) — 20 each

Leg Spotlights (2; knees) — 5 each

Chest Spotlights (2) — 5 each

Pilot View Port (1) — 50
Pilot View Port Shield (slides into place as needed) — 50
*Head & Sensors (1) — 75
**Main Body — 500
Reinforced Pilot's Compartment — 150

* Destroying the sensor head of the bot will eliminate all forms of optical enhancement and sensory systems. The pilot must then rely on his own human vision and senses without bonuses to strike, parry, and dodge from the bot. It is a difficult target to hit and can only be struck when a character makes a *called shot*, and even then the attacker is -4 to strike. The same penalty applies to striking the hands and feet. The view port in the chest also requires an attacker to make a called shot and is -9 to strike.

**Depleting the M.D.C. of the main body will shut the armor down completely, making it useless.

Speed

Running: 70 mph (112.6 km) maximum. Note that the act of running does NOT tire out its operator. Cruising speed is usually around 40 mph (64 km). The bot is well suited for most terrains, including underwater. It is also reasonably good at climbing rope/cables and mountains, however it cannot climb sheer walls. The Super Hunter is also suitable for labor, mining and construction.

Leaping: 20 feet (6 m) high or lengthwise from a stationary position; 30 feet (9 m) high or 40 feet (13.7 m) lengthwise from a running start.

Flying: Not possible.

Statistical Data

Height: 18 feet (5.4 m)

Width: 9 feet (2.7 m)

Length: 6 feet (1.8 m)

Weight: 8 tons fully loaded.

Physical Strength: Equal to a P.S. 50

Cargo: Small area for the pilot's personal items.

Power System: Nuclear, average energy life is 15 years.

Black Market Cost: 16 million credits for a new, undamaged basic unit with rail gun and missiles.

Weapon Systems

1. TX-250 Rail Gun (1 or 2): This is the standard handgun for the X-545 Armored Jager. Only one is issued to this bot. Other rail guns can be substituted.

Primary Purpose: Assault

Secondary Purpose: Defense

Weight: Gun: 250 lbs (112.5 kg). One TX-250 Ammo-Drum is another 250 lbs (112 kg). The ammo-drum hooks to the back of the bot.

Mega-Damage: A full damage burst fires 30 rounds and inflicts 6D6 M.D. A short burst of 15 rounds does 3D6 M.D. and a single round does 1D4 M.D.

Rate of Fire: Equal to number of combined hand to hand attacks (usually 4-8).

Maximum Effective Range: 6000 feet (1828 m)

Payload: The short clip holds 300 rounds and is capable of firing 10 full damage bursts (30 rounds) or 20 half damage short bursts (15 rounds).

The 3000 round drum is capable of firing 100 full damage bursts or 200 half damage bursts (15 rounds). Reloading a drum

will take about three minutes for those not trained, but a mere one minute by somebody trained in the use of power armor. A strength of 28 or higher is required to handle the drum.

Special TX-250 Feature: 1) The rail gun has its own laser targeting and radar tracking system built into the weapon itself (the large round cylinder). This can be especially useful if the sensor head is destroyed. Range: 6000 feet (1828 m). Bonuses: +1 to strike, +1 to parry and dodge.

2. Head Guns (2): On the top of the Armored Jager's head are two tiny ports that are rapid-fire guns. They are used primarily against D-bee refugees and non-mega-damage foes. The real bullets can be replaced with rubber ones for riot control.

Primary Purpose: Riot control

Weight: None; they are a part of the robot.

Mega-Damage: A full damage burst fires 30 rounds and inflicts 6D6 S.D.C., a short burst of 15 rounds does 3D6 S.D.C.; a single round cannot be fired.

Rate of Fire: Equal to number of combined hand to hand attacks (usually 4-8).

Maximum Effective Range: 2000 feet (610 m)

Payload: 2000 rounds capable of firing 66 full damage bursts or 133 half damage bursts (15 rounds). Reloading a drum will take about five minutes for those not trained or two minutes by field mechanics. A strength of 20 or higher is required to handle the replaceable ammo drum concealed inside the head.

3. Ion Cannons (2): The two large protrusions from the lower chest area are ion cannons. Both can be angled 30 degree in all directions.

Primary Purpose: Anti-Gargoyle/Giant

Secondary Purpose: Anti-Personnel

Mega-Damage: 1D4 x 10 per single blast or 2D4 x 10 per simultaneous double blast.

Maximum Effective Range: 3000 feet (914 m)

Cannon Rate of Fire: Equal to number of combined hand to hand attacks (usually 4-8).

Cannon Payload: Effectively unlimited.

4. Shoulder Mini-Missile Launchers (2): Located in the shoulder area and down the back are concealed mini-missile launchers.

Primary Purpose: Anti-Aircraft

Secondary Purpose: Anti-Personnel

Missile Type: Any mini-missile can be used, but standard issue is armor piercing (1D4 x 10 M.D.) or plasma (1D6 x 10). Fragmentation and/or tear gas may be used for anti-personnel operations.

Mega-Damage: Varies with missile type.

Range: Usually about a mile.

Rate of Fire: One at a time or in volleys of 2, 4 or 6.

Payload: 24 total; 12 in each shoulder region.

5. Forearm Mini-Missile Launchers (2): Located in each forearm are concealed mini-missile launchers.

Primary Purpose: Anti-Aircraft

Secondary Purpose: Anti-Personnel

Missile Type: Any mini-missile can be used, but standard issue is armor piercing (1D4 x 10 M.D.) or plasma (1D6 x 10). Fragmentation and/or tear gas may be used for anti-personnel operations.

Mega-Damage: Varies with missile type.

Range: Usually about a mile.

Rate of Fire: One or two.

Payload: Six total; three in each arm.

6. Forearm Vibro-Sword (2): Located in each forearm is a concealed, extendable and retractable vibro-sword. The weapon is six feet long (1.8 m).

Primary Purpose: Defense

Mega-Damage: 4D6 M.D.

7. Lower Leg Mini-Missile Launchers (2): Located in the calf of each leg are mini-missile launchers.

Primary Purpose: Anti-Aircraft

Secondary Purpose: Ant-Personnel

Missile Type: Any mini-missile can be used, but standard issue is armor piercing (1D4 × 10 M.D.) or plasma (1D6 × 10). Fragmentation and/or tear gas may be used for anti-personnel operations.

Mega-Damage: Varies with missile type.

Range: Usually about a mile.

Rate of Fire: One or two.

Payload: 8 total; four in each leg.

8. Flamethrowers (2): A small flamethrower turret, capable of 360 degree rotation is located on the inside of each lower leg.

Primary Purpose: Anti-Personnel

Secondary Purpose: Vegetation removal

Mega-Damage: 1D4 M.D. per single blast or 2D4 per simultaneous double blast of napalm-like fire. Plus there is a 01-95% likelihood of setting all combustible material, including fuel, wood, dry grass, clothes and hair, on fire. Furthermore, the nature of the chemical fire and intense heat is such that there is a 01-60% likelihood of setting living plants and trees on fire. The fire does an additional 1D4 M.D. per melee round and burns for a minimum of 2D4 minutes.

Maximum Effective Range: 200 feet (61 m)

Rate of Fire: Equal to number of combined hand to hand attacks (usually 4-8).

Payload: 20 blasts total, 10 from each leg.

9. Hand to Hand Combat: Rather than use a weapon, the pilot can engage in mega-damage hand to hand combat. The speed of the X-545 Super Hunter gives it a different range of damage and bonuses than those listed in the **Rifts RPG**.

Bonuses & Damage from X-545 Super Hunter/Armored Jager Combat Training

Restrained Punch — 1D6 M.D.

Full Strength Punch — 2D6 M.D.

Power Punch — 3D6 M.D. (counts as two attacks)

Crush, Pry or Tear: 1D6 M.D.

Kick — 1D6 M.D.

Leap Kick — Not possible

Body Flip/Throw — 1D4 M.D.

Body Block/Ram — 2D4 M.D.

+2 to strike

+3 to parry

+2 to dodge

+2 to roll with impact

+2 to pull punch

+1 melee action/attack at levels 1, 3, 6, and 10.

10. Sensor Systems Note: The X-545 Armored Jager has full optical systems, including laser targeting, telescopic, passive night vision (light amplification), thermo-imaging, infrared, ultraviolet, and polarization. Plus all other features common to most robots.

Triax X-622 Bug

The Bug or Kaefer, is a robot vehicle that can hold as many as six people. It is designed to be a light assault infantry support vehicle and APC. It is an excellent all-terrain vehicle able to scurry among rocks and low mountains, across grasslands, through forests as well as on and under water. The Kaefer has been built with flotation/ballast mechanisms that enable it to float and skim along on the surface of the water like a beetle. This makes it a truly "all" terrain vehicle and ideal for bases, outposts and cities along the many rivers in the NGR and north-western Europe. It comes in light grey, medium green and camouflage (as do most of the bots and vehicles).

X-622 Bug

Exclusive to the NGR Military

German Name: der Kaefer (pronounced kay fur)

Model Type: X-622

Class: Ground Infantry Assault Robot

Crew: Two, a pilot and co-pilot/gunner. It can also accommodate four passengers comfortably.

M.D.C. by Location:

Forward Gun Turret (1) — 100

Ammo-Drum (1; belly) — 100

Rear Laser Turret (1, top) — 150

Rear Laser Turret Sensor/Optics (1) — 20

Arms/Legs (4) — 200 each

Claws (4) — 60 each

Rear Engine Section (for travelling on water) — 100

Flip-Top Missile Launcher (1; top) — 90

Main Hatch (1; side) — 90

Small Escape Hatch (2; rear side) — 45 each

Infrared Searchlight (1, large) — 15

Conventional Spotlights (2, forward) — 10 each

Forward Gun Turret Sensor/Targeting (1) — 25

*Forward Sensor Array (1 section) — 30

**Main Body — 400

Reinforced Pilot's Compartment — 100

* The forward sensor array encompasses the two smaller circular lenses clustered around the large infrared searchlight. Destroying this area will destroy the two sensors and eliminate all forms of *optics and optical enhancement and general sensor systems*. The vehicle is partially blinded and the pilot must rely entirely on instrument readings. All combat bonuses are reduced by half and travelling at more than half speed is dangerous (the vehicle may crash into something, fall into a pit or crevice, plow into the enemy, etc.). The optics section is a difficult target to hit and can only be struck when a character makes a *called shot*, and even then the attacker is -2 to strike.

Note One: The forward gun and rear laser turret both have independent targeting and short-range radar (5 mile/8 km radius). The rear laser turret gunner also has independent optics but the best angle of view is from behind the Bug or from the rear top. If the turret is pointed forward, the co-pilot/gunner can see things in front of the bot in the distance. He has several blind spots: Anything below the shoulder of the Bug up to about 20 feet (6 m) away from the side and a 50 foot (15.2 m) area directly in front of the vehicle. One alternative is to have a "lookout" sitting on the head (top front

section) of the vehicle providing verbal data or relaying images from a handheld video camera. Of course this is not practical during heavy combat.

Note Two: The sensors on the forward gun and rear turret are difficult targets to hit and the attacker must make a *called shot* and is -4 to strike. The two lower spotlights are equally difficult to hit.

**Depleting the M.D.C. of the main body will shut the robot down completely, making it useless.

Speed

Land Speed: 60 mph (96 km) crawling/scurrying in unobstructed environments like on a city street and open plains. Cruising speed is usually 40 mph (64 km). Reduce the speed by 20% when travelling through woodlands, swamps or very rough terrain. Reduce the speed by 50% when travelling through dense forests and extremely difficult (rocky, steep, obstacle filled) terrain. The bot is well suited for most terrains, including water.

Surface Water Travel: The Bug can travel at 30 mph (48 km) on the surface of water, including lakes, rivers and the ocean. Destroying the rear engine only disables the Bug's ability to move quickly on the surface of water. It can still push/swim with its arms at about 5 mph (8 km) or crawl along the bottom of riverbeds and shallow lakes.

Underwater Travel: The Bug can function like a mini-submarine. Safe maximum depth is 300 feet (91.5 m). However, the vehicle can go as deep as 600 feet (183 m), but the crew and passengers will have to surface slowly to avoid the "bends" (decompression sickness which can be lethal). The Bug can travel through the water like a submarine using its rear engine or crawl along the bottom. Engine speed is 30 mph (48 km). Crawling speed is a maximum of 20 mph (32 km). Swimming underwater with its claws/arms is about 3 mph (4.8 km).

Leaping: Not possible, but the Bug is a good climber as long as the incline is not over 60 degrees. It can also use its claws to grab rocks, trees and handholds to pull itself.

Flying: Not possible.

Statistical Data

Height: 13 feet (4 m) fully erect. The actual body section is roughly 7 feet (2.1 m) from belly to top.

Width: 6 feet (1.8 m)

Length: 17 feet (5.2 m)

Weight: 8 tons fully loaded.

Physical Strength: Equal to a P.S. 40

Cargo: There are three areas the size of a large glove compartment for the pilot and co-pilots personal items. There is also a small 3×3×3 foot (1 m) storage compartment toward the rear and 100 gallon (378.5 liter) water cooler.

Power System: Nuclear, average energy life is 20 years.

Black Market Cost: 9 million credits for a new, undamaged, full combat unit, complete with missiles and weapons. 6 million without weapons. Poor availability for either.

Weapon Systems

1. TX-150 "Man-Killer" Forward Rail Gun (1): The TX-150 can fire most types of rail gun ammunition, but standard issue is depleted uranium rounds. These special rounds are made from old nuclear material with only trace levels of radiation. However, the material is much heavier than normal slugs, giving it much greater armor piercing and damage capability.

Other rail guns can be substituted in an emergency or if so desired.

Primary Purpose: Assault

Secondary Purpose: Defense

Weight: Gun: 1250 lbs (562.5 kg); attached to the forward turret housing.

Mega-Damage: Depleted Uranium slugs inflict 1D6×10 M.D. from a standard burst of 30 rounds. This weapon can only fire bursts.

Rate of Fire: Equal to number of combined hand to hand attacks (usually 4-8).

Maximum Effective Range: 4000 feet (1200 m)

Payload: 3000 round drum is capable of firing 100 bursts. Reloading a drum will take about three minutes for those not trained, but a mere one minute by a field mechanic. A strength of 28 or higher is required to handle the drum.

Special Features: 1) The rail gun has its own laser targeting and short-range radar (5 mile/8 km) tracking system built into the weapon itself (the circular plate on the side). This can be especially useful if the main body sensors are destroyed. Laser targeting range is 6000 feet (1828 m). **Bonus:** +2 to strike.

2) The rail gun is attached to a turret that can rotate 360 degrees. The gun itself can move up and down at a 90 degree angle.

3) Low radiation Uranium Rounds (U-Rounds) can be substituted for more conventional bullets. These rounds have a low level of radiation so they must be used with caution. They are usually made available for campaigns outside the New German Republic.

The complete description of U-Rounds is found in the weapon section. Basically, the NGR has discovered that radioactive rounds inflict additional damage and prevents the incredible bio-regenerative powers of most supernatural beings and creatures of magic, such as dragons and werewolves. Wounds/damage caused by U-Rounds cannot be bio-regenerated until the rounds are removed and then the regeneration process is extremely slow. U-Rounds inflict 2D4×10 M.D. to such creatures. Depleted Uranium rounds do not inflict additional damage or prevent healing, but do hurt badly and seem to burn supernatural beings.

2. Rear Laser Turret: The laser turret is located on the top rear section of the robot vehicle. The turret can rotate 360 degrees and the barrel can be pointed up and down in a 90 degree arc of fire. The turret has independent targeting, radar (5 m/8 km), and optic systems. The gun is a rapid-fire pulse laser known for its reliability, range and precision. Typically the pilot drives and operates the forward gun while the co-pilot operates the laser turret.

Primary Purpose: Defense

Secondary Purpose: Anti-Personnel

Mega-Damage: 2D6 M.D. per single blast or 6D6 rapid-fire pulse of three nearly simultaneous blasts.

Rate of Fire: Equal to number of combined hand to hand attacks (usually 4-6).

Maximum Effective Range: 4000 feet (1200 m)

Payload: Effectively unlimited.

Special Features: 1) The laser turret has its own optical, laser targeting, short range radar (5 mile/8 km) and tracking system built into the weapon housing (the rectangular appendage on top). This can be especially useful if the main body sensors are

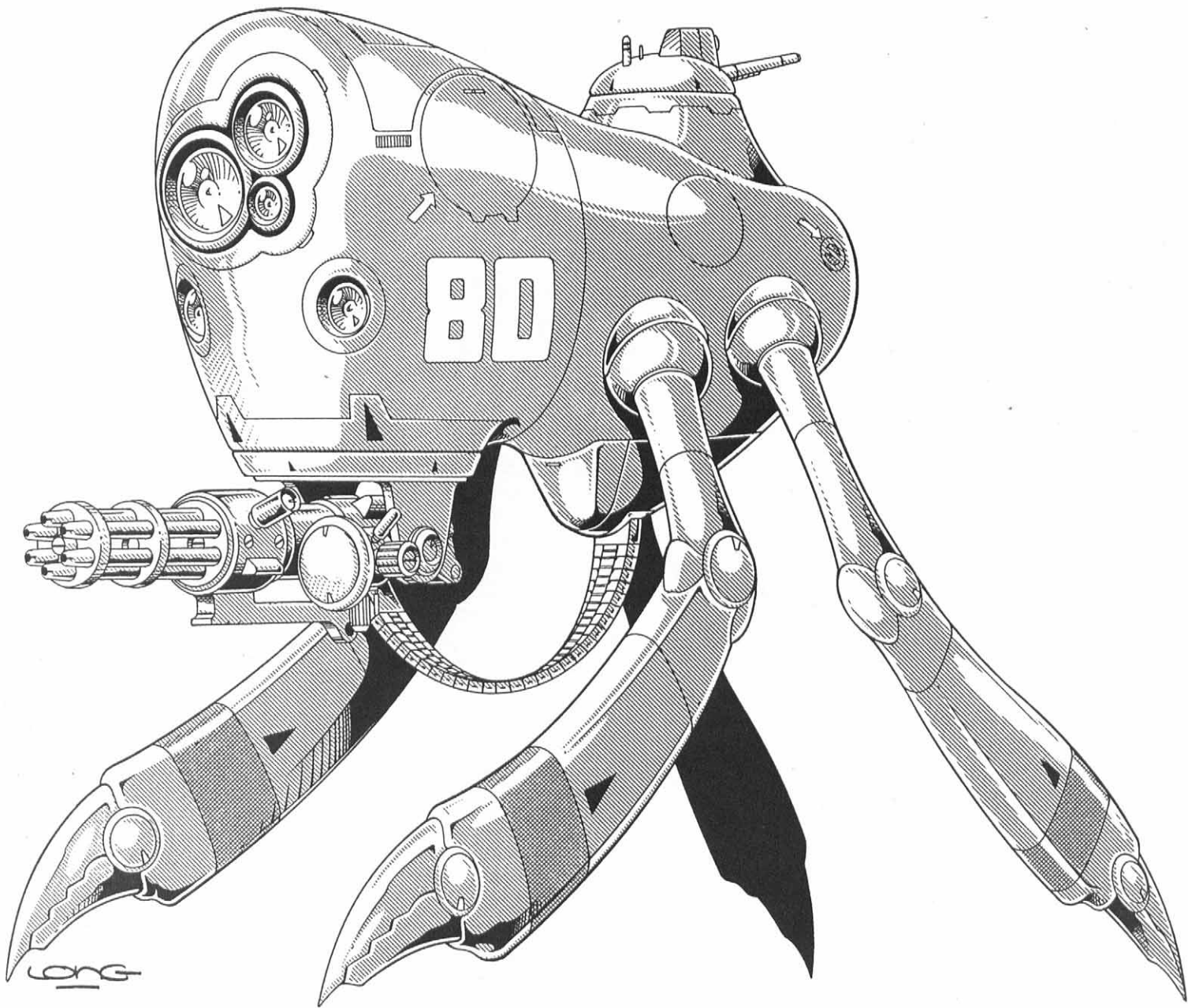

destroyed. Laser targeting range is 6000 feet (1828 m). Bonus: +2 to strike.

2) The turret can rotate 360 degrees. The gun itself can move up and down at a 90 degree angle.

3. Flip-Top Mini-Missile Launcher (1): Located on top of the front, head, section is a concealed mini-missile launcher. The top flips up and the missiles are launched.

Primary Purpose: Anti-Aircraft

Secondary Purpose: Ant-Personnel

Missile Type: Any mini-missile can be used, but standard issue is armor piercing (1D4 × 10 M.D.) or plasma (1D6 × 10). Fragmentation and/or tear gas may be used for anti-personnel operations.

Mega-Damage: Varies with missile type.

Range: Usually about a mile.

Rate of Fire: One at a time, or in a volley of two, three or four.

Payload: 8 total.

4. Hand to Hand Combat: Rather than use a weapon, the pilot can engage in mega-damage hand to hand combat. The crab-

like claws can strike closed, or open and close to cut, snap, crush or tear at enemy armor. The claws can also be used to grab onto trees, rocks, other robots or vehicles, and so on to immobilize the enemy or to grab a handhold and climb.

Bonuses & Damage from X-622 Bug Combat Training:

Restrained Claw strike — 1D6 M.D.

Full Strength Punch — 2D6 M.D.

Power Punch — 4D6 M.D. (counts as two attacks)

Crush or Pry with claws — 2D4 M.D.

Cut/Snap or Tear with claws — 2D6 M.D.

Kick — Not possible

Leap Kick — Not possible

Body Flip/Throw — 1D6 M.D.

Body Block/Ram — 2D6 M.D. (counts as two attacks)

+1 to strike

+2 to parry

+2 to dodge

+2 to roll with impact

+2 to pull punch

+1 melee action/attack at levels 1, 3, 7, and 11.

5. Sensor Systems Note: Standard robot features. The infrared searchlight has a range of 1000 feet (305 m) and is invisible to the human eye (and most D-bees and demons); visible only via another infrared optics system.

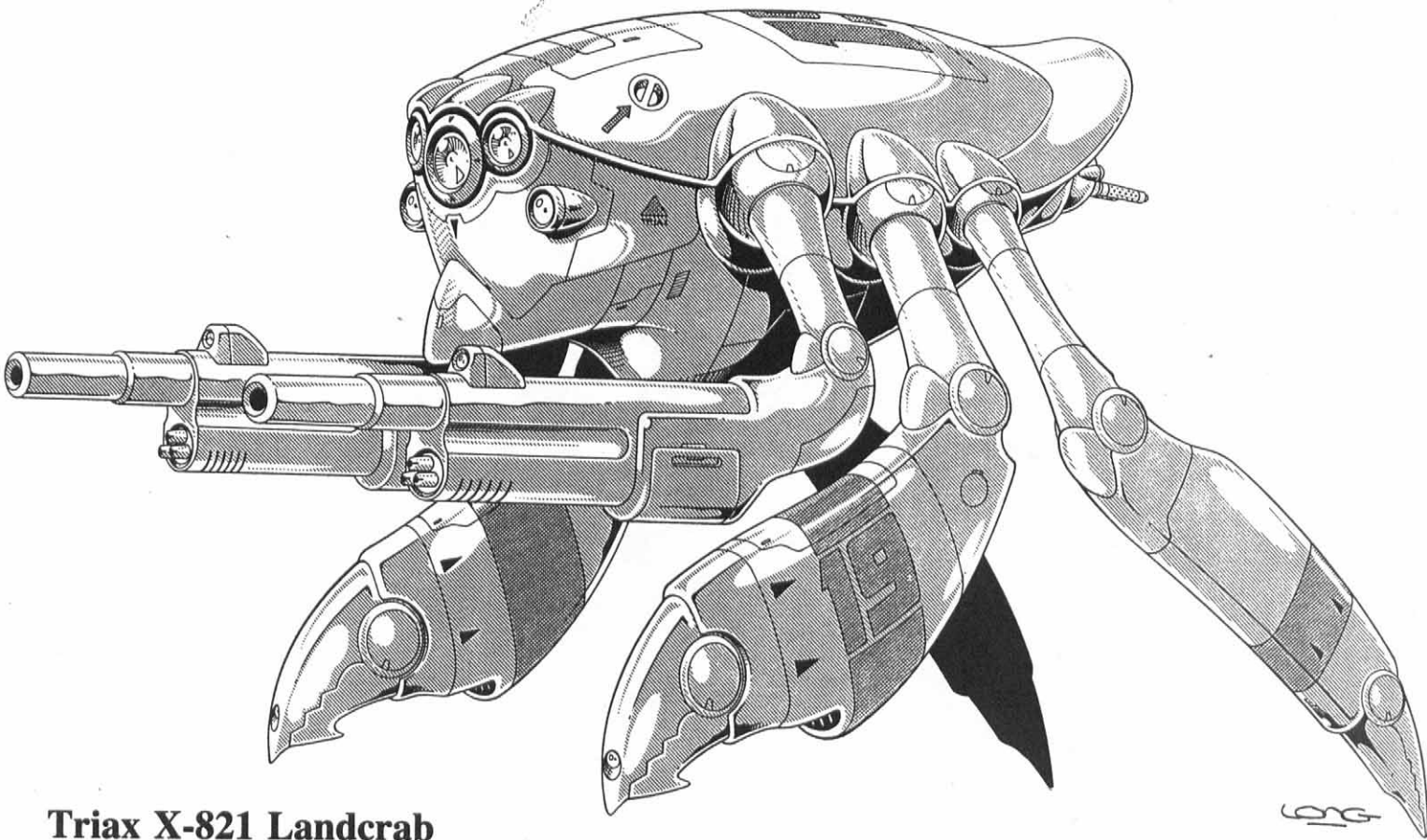

Triax X-821 Landcrab

The Landcrab is a larger, more heavily armed and armored version of the Bug. It is designed to be a heavy assault infantry support vehicle and APC. It is an excellent all-terrain vehicle able to scurry among rocks and low mountains, across grasslands, through forests as well as on and under water. The Landcrab has an extra pair of arms sporting a pair of particle beam cannons and rail guns. It comes in the colors light grey, medium green and camouflage.

X-821 Landcrab Robot APC

Exclusive to the NGR Military

German Name: der Landeskranne
(pronounced: Lan des krab bah)

Model Type: X-821

Class: Ground Infantry Assault Robot & Armored Personnel Carrier

Crew: Two, a pilot and co-pilot/gunner. It can also accommodate as many as 12 passengers comfortably.

M.D.C. by Location:

- Concealed Missile Launcher (1; top) — 100
- Forward Arm Guns (2) — 200 each
- Rear Laser Turrets (2) — 70 each
- Rear Optics (1) — 20
- Arms/Legs (4) — 300 each
- Large Claws (2; forward limbs) — 200 each
- Small Claws (2; rear limbs) — 100 each
- Rear Engine Section (for travelling on water) — 100

- Main Hatch (1; top) — 100
- Small Escape Hatch (1; rear, side) — 45
- Infrared Searchlight (1, large) — 15
- Conventional Spotlights (2, forward) — 10 each
- Forward Gun Turret Sensor/Targeting (1) — 25
- *Forward Sensor Array (1 section) — 40
- **Main Body — 650
- Reinforced Pilot's Compartment — 100

* The forward sensor array encompasses the two smaller circular lenses clustered around the large infrared searchlight. Destroying this area will destroy the two sensors and eliminate all forms of *optics and optical enhancement* and general sensor systems. The vehicle is partially blinded and the pilot must rely entirely on instrument readings. All combat bonuses are reduced by half and travelling at more than half speed is dangerous (the vehicle may crash into something, fall into a pit or crevice, plow into the enemy, etc.) The optics section is a difficult target to hit and can only be struck when a character makes a *called shot*, and even then the attacker is -2 to strike.

Note One: The forward gun and rear laser turret both have independent targeting and short-range radar (5 mile/8 km radius). The laser turret gunner also has independent optics but the best angle of view is from behind the Landcrab or from the rear top. If the turret is pointed forward the co-pilot/gunner can see things in front of the bot in the distance. He has several blind spots: Anything below the shoulder of the

Landcrab up to about 20 feet (6 m) away from the side and a 50 foot (15.2 m) area directly in front of the vehicle. One alternative is to have a "lookout" sitting on the head (top front section) of the vehicle providing verbal data or relaying images from a handheld video camera. Of course, this is not practical during heavy combat.

Note Two: The sensors on the forward gun and rear turret are difficult targets to hit and the attacker must make a *called shot* and is -4 to strike. The two lower spotlights are equally difficult to hit.

**Depleting the M.D.C. of the main body will shut the robot down completely, making it useless.

Speed

Land Speed: 60 mph (96 km) crawling/scurrying in unobstructed environments like on a city street or the open plains. Cruising speed is usually 40 mph (64 km). Reduce the speed by 20% when travelling through woodlands, swamps or very rough terrain. Reduce the speed by 50% when travelling through dense forests and extremely difficult (rocky, steep, obstacle filled) terrain. The bot is well suited for most terrains, including water.

Surface Water Travel: The Landcrab can travel 20 mph (32 km) on the surface of water, including the ocean, like a boat. Destroying the rear engine only disables the vehicle's ability to move quickly on the surface of water. It can still push/swim with its arms at about 5 mph (8 km) or crawl along the bottom of riverbeds and shallow lakes.

Underwater Travel: The Landcrab can function like a mini-submarine. Safe maximum depth is 300 feet (91.5 m). However, the vehicle can go as deep as 1000 feet (305 m), but the crew and passengers will have to surface slowly to avoid the "bends" (decompression sickness, which can be lethal). The robot vehicle can travel through the water like a submarine using its rear engine or crawl along the bottom. Engine speed is 20 mph (32 km). Crawling speed is a maximum of 15 mph (24 km). Swimming underwater with its claws/arms is about 3 mph (4.8 km).

Leaping: Not possible, but the Landcrab is a fair climber.

Flying: Not possible.

Statistical Data

Height: 18 feet (4.4 m) fully erect. The actual body section is roughly 10 feet (3 m) from belly to top.

Width: 10 feet (3 m)

Length: 24 feet (7.3 m)

Weight: 14 tons fully loaded.

Physical Strength: Equal to a P.S. 60

Cargo: There are three areas the size of a large glove compartment for the pilot's and co-pilot's personal items. There is also a small 4x4x4 foot (1.2 m) storage compartment toward the rear and a 100 gallon (378.5 liter) water cooler.

Power System: Nuclear, average energy life is 20 years.

Black Market Cost: 14 million credits for a new, undamaged, full combat unit, complete with missiles and weapons. 10 million without weapons. Poor availability for either.

Weapon Systems

1. Forward Weapon Arms (2): The front arms of the Landcrab are two identical multi-weapon appendages. The big gun is a particle beam cannon. Below it is a rapid-fire rail gun. The rail gun can fire most types of rail gun ammunition, but standard issue is depleted uranium rounds. These special rounds are made from old nuclear material with only trace

levels of radiation. However, the material is much heavier than normal slugs, giving it much greater armor piercing and damage capability.

The arms have the same basic range of movement as a human arm. They can swing side to side and up and down in a 180 degree arc of movement.

Particle Beam Cannon

Primary Purpose: Anti-Armor

Secondary Purpose: Defense

Mega-Damage: 2D4 x 10 M.D. per single blast!

Rate of Fire: Equal to number of combined hand to hand attacks (usually 4-8).

Maximum Effective Range: 2000 feet (610 m)

Payload: Effectively unlimited.

Special Feature: Independent power supply.

Rail Gun

Primary Purpose: Anti-Personnel

Secondary Purpose: Defense & Assault

Mega-Damage: Depleted uranium slugs inflict 1D4 x 10 M.D. from a standard burst of 20 rounds. This weapon can only fire bursts.

Rate of Fire: Equal to number of combined hand to hand attacks (usually 4-8).

Maximum Effective Range: 4000 feet (1200 m)

Payload: 2000 round drum is capable of firing 100 bursts. Reloading a drum will take about three minutes for those not trained, but a mere one minute by a field mechanic. A strength of 28 or higher is required to handle the drum.

Special Features: 1) The weapon has infrared targeting beams mounted on top of each barrel. Light beam range is 4000 feet (1200 m). Bonus: +1 to strike.

2) Low radiation Uranium Rounds (U-Rounds) can be substituted for more conventional bullets. These rounds have a low level of radiation so they must be used with caution. They are usually made available for campaigns outside the New German Republic. U-Rounds inflict 1D6 x 10 M.D. to supernatural creatures. Depleted uranium rounds do not inflict additional damage or prevent healing, but do hurt badly and seem to burn supernatural beings.

2. Rear Laser Turrets (2): Two small laser turrets are located in the rear section of the robot vehicle. Each turret can fire in a 60 degree angle in all directions and can fire in unison at the same target or at two different targets.

In between the turrets is a secondary optical and sensory system to prevent enemy attacks from behind. The sensor package offers all the standard robot features. Typically the pilot drives and operates the forward guns while the co-pilot operates the laser turrets.

Primary Purpose: Defense

Secondary Purpose: Anti-Personnel

Mega-Damage: 3D6 M.D. per single blast or 6D6 per dual, simultaneous blasts from both lasers aimed at the same target.

Rate of Fire: Equal to number of combined hand to hand attacks (usually 4-6).

Maximum Effective Range: 4000 feet (1200 m)

Payload: Effectively unlimited.

3. Concealed Mini-Missile Launcher (1): The rear panel with the identification number on the back of the robot vehicle conceals a mini-missile launcher. The front section of the

plate raises up to fire missiles and then snaps shut to prevent damage from retaliatory attacks.

Primary Purpose: Anti-Aircraft

Secondary Purpose: Ant-Personnel

Missile Type: Any mini-missile can be used, but standard issue is armor piercing (1D4 × 10 M.D.) or plasma (1D6 × 10). Fragmentation and/or tear gas may be used for anti-personnel operations.

Mega-Damage: Varies with missile type.

Range: Usually about a mile.

Rate of Fire: One at a time, or in a volley of two, three or four.

Payload: 16 total.

4. Hand to Hand Combat: Rather than use a weapon, the pilot can engage in mega-damage hand to hand combat. The crab-like claws can strike closed, or open and close to cut, snap, crush or tear at enemy armor. The claws can also be used to grab onto trees, rocks, other robots or vehicles, and so on to immobilize the enemy or to grab a handhold and climb.

Bonuses & Damage from X-821 Landcrab Combat Training:

Restrained Claw strike — 1D6 M.D.

Full Strength Punch — 3D6 M.D.

Power Punch — 5D6 M.D. (counts as two attacks)

Crush or Pry with claws — 2D6 M.D.

Cut/Snap or Tear with claws — 3D6 M.D.

Kick — Not possible

Leap Kick — Not possible

Body Flip/Throw — 1D6 M.D.

Body Block/Ram — 3D6 M.D.

+1 to strike

+3 to parry

+2 to dodge

+1 to roll with impact

+1 to pull punch

+1 melee action/attack at levels 1, 3, 7, and 11.

5. Sensor Systems Note: Standard robot features.

an excellent support and defense weapon as well as a heavy assault unit. However, the Jager, Predator, and other bots are much faster and more versatile, making them ideal for a wider range of military use and tactics.

X-1000 Ulti-Max Power Armor

Part of the Army of the NGR

German Name: das Ulti-Max

Model Type: X-1000

Class: Strategic Armor Military Assault Suit

Crew: One

M.D.C. by Location:

Rear Exhaust Tubes (2) — 50 each

Rear Booster Jet (1) — 50 each

VX-180 Maxi-Rail Gun (1) — 100

VX-180 Laser (1) — 15

VX-180 Targeting System (1) — 20

Mini-Missile Shoulder Launchers (2) — 150 each

Forearms (2) — 120 each

Upper arms (2) — 100 each

Legs (2) — 200 each

Head Spotlight (1) — 10

Communications Cluster (1, top, rear) — 30

*Head Sensors (top) — 70

**Main Body — 400

Force field — 100

Reinforced Pilot's Compartment — 80

* Destroying the sensor head of the power armor will eliminate all forms of optical enhancement and sensory systems. The pilot must now rely on his own human vision and senses (and the VX-180 rail gun targeting system). No power armor combat bonuses to strike, parry, and dodge (rail gun bonuses are still applicable if intact). **Note:** The sensor head is a small and difficult target to hit (shielded by exhaust tubes and shoulder plating). Thus, it can only be hit when a character makes a *called shot* and even then the attacker is -4 to strike.

Depleting the M.D.C. of the main body will shut the armor down completely, making it useless. **Note: Destroying the booster jet will not significantly impair the X-1000's movement; reduce maximum speed to 40 mph (64 km) and it suffers a penalty of -1 to dodge.

Speed

Running: 44 mph (70 km) maximum. Note that the act of running does NOT tire out its operator. Cruising speed is a more cautious 35 mph (56 km). Well suited for most terrains, including underwater, but not so well suited for climbing or mountain terrain. The rear booster jet is helpful though in maintaining stability on uneven ground and against concussion from enemy bombardment.

Leaping: Not possible!

Flying: Not possible! The rear rocket system is provided to add stability and balance, nothing more.

Statistical Data

Height: 16 feet (4.9 m) from head to toe, but the large exhaust tube extends to about 20 feet (6 m).

Width: 9 feet (2.7 m)

Length: 7 feet, 6 inches (1.9 m)

Weight: 2.5 tons

Physical Strength: Equal to a P.S. 40

Triax X-1000 Ulti-Max Power Armor

The X-1000 Ulti-Max may be one of the most powerful types of power armor ever developed by post-rifts technology. Some feel that it rivals the famous Glitter Boys in sheer firepower and protection. Many argue that the Ulti-Max is not power armor at all, but a super sophisticated, miniaturized robot. Most consider it to be power armor because it is a one-man robot and is super light (2.5 tons) when compared to most robot vehicles. However, the pilot does sit at a control console and the armor is completely automated. Regardless of whether it is a robot or power armor, the Ulti-Max is a fabulous war machine offering all-terrain capabilities, heavy armor, and vast firepower.

Despite the Ulti-Max's tremendous potential and power, Triax considers most of its weapon and defense systems to be experimental. Consequently, it was first "test marketed" overseas in the Coalition States before being put into production for the NGR military. The Ulti-Max has performed admirably in the field of combat and is becoming a pivotal infantry unit in the army of the New German Republic. The main advantage to the X-1000 is the amount of damage it can endure. This makes it

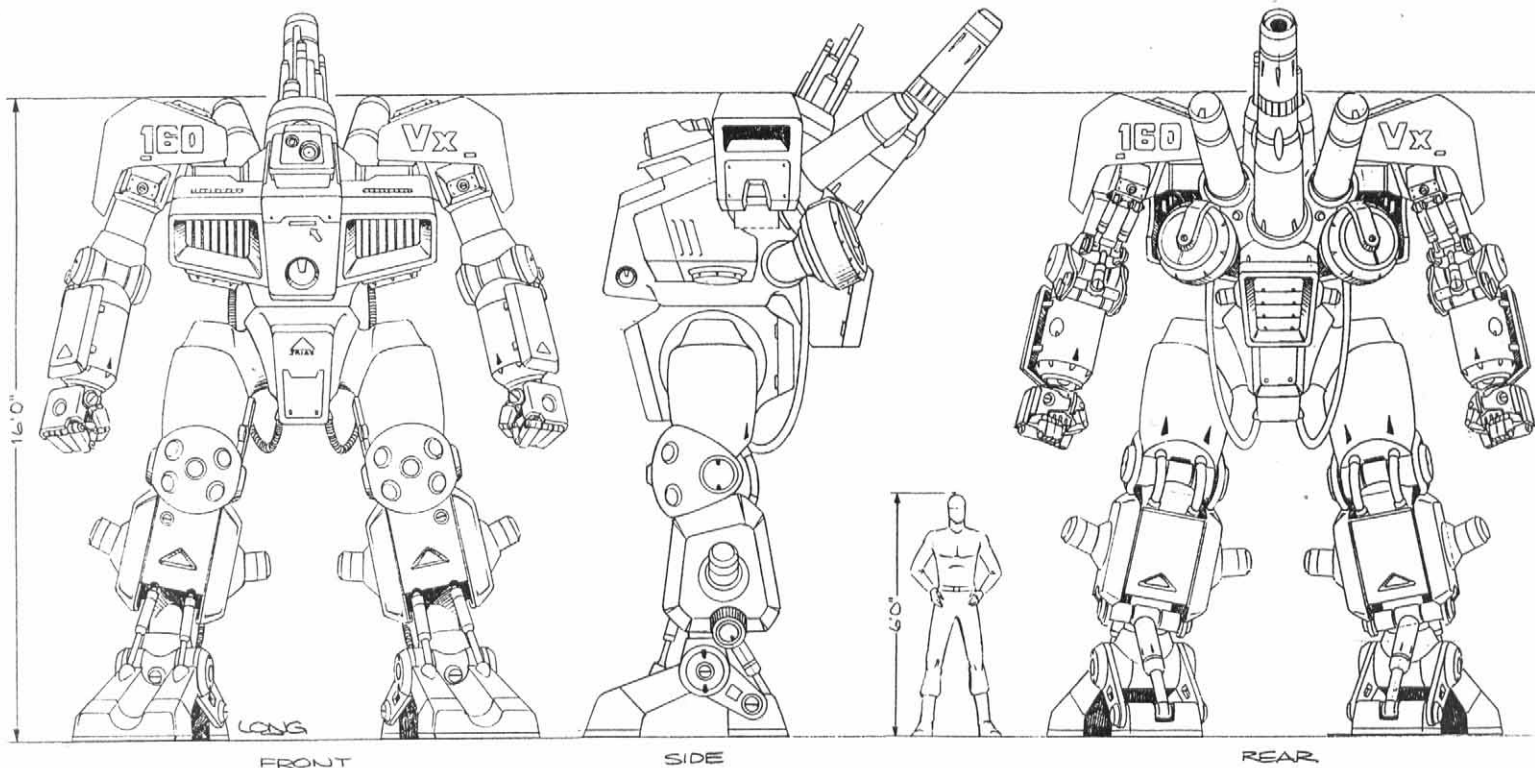

Cargo: Small area for the pilot's personal items, as well as a weapon bin that has room for one rifle, one pistol, light body armor, canteen and food rations (4 week supply). A two gallon (7.6 l) water cooler is built into the unit.

Power System: Nuclear, average energy life is 20 years.

Black Market Cost: 22 million credits average, but has been known to sell for twice as much from time to time, for a new, undamaged, fully powered suit complete with the VX-180 Maxi-rail gun and mini-missiles. Poor availability.

Weapon Systems

1. VX-180 Maxi-Rail Gun (1): This is the standard weapon for the X-1000 Ulti-Max and is one of the most powerful, long-range rail guns in the world. The weapon is hooked directly to the armor's nuclear power supply eliminating the need for an external power pack. Other rail guns can be substituted in an emergency.

Primary Purpose: Assault

Secondary Purpose: Defense

Weight: Gun: 350 lbs (157 kg). One VX-180 Ammo-Drum: 200 lbs (90 kg); two ammo-drums are standard.

Mega-Damage: A burst is 40 rounds and inflicts $1D6 \times 10$ M.D.

This weapon can only fire bursts.

Rate of Fire: Equal to number of combined hand to hand attacks (usually 4-6).

Maximum Effective Range: 6000 feet (1828 m)

Payload: 4000 round drum, that's 100 bursts. The second drum feeds immediately after the first drum is exhausted. Reloading a drum will take about 5 minutes for those not trained, but a mere one minute by somebody trained in the use of power armor; a strength of 26 or higher is required.

Special VX-180 Features: 1) The rail gun has its own laser targeting and radar tracking system built into the weapon itself (the large round cylinder). Range: 6000 feet (1828 m). Bonuses: +2 to strike, +1 to parry and dodge.

2) A small, variable light frequency laser (the smaller cylinder) is also part of the VX-180's weapon system. The laser draws its power from the power armor itself, but also has an auxiliary energy-clip in case of an emergency. E-Clip Payload: 40 shots. Mega-damage: $2D6$ M.D. Range: 4000 feet (1200 m)

3) The VX-180 can also fire "man-killer" depleted uranium rounds, adding +10 M.D. to the normal rail gun damage per 40 round burst, as well as U-rounds which also provide +10 M.D. (+20 against supernatural beings). Both types of special rounds are only provided for special assignments.

2. VX-160 Mini-Missile Launchers (2): A letter box style mini-missile launcher is mounted above both shoulders and offers additional protection to the sensor head, as well as greater fire-power.

Primary Purpose: Anti-Aircraft

Secondary Purpose: Anti-Armor

Missile Type: Any mini-missile can be used, but standard issue is an equal number of armor piercing ($1D4 \times 10$ M.D.) and plasma ($1D6 \times 10$) missiles. Fragmentation or riot control types may be used for anti-personnel operations.

Mega-Damage: Varies with missile type.

Range: Usually about one mile (1.6 km).

Rate of Fire: One, or in volleys of two, four, or six.

Payload: 30 total; 15 in each box.

3. Hand to Hand Combat: Rather than use a weapon, the pilot can engage in mega-damage hand to hand combat. See *Basic and Elite Power Armor Combat Training* in the Robot Combat section of **Rifts**, page 45. All abilities are the same except as follows:

Restrained Punch — $1D4$ M.D.

Full Strength Punch — $2D4$ M.D.

Power Punch — $3D6$ M.D.

Leaps and Kicks are not possible.

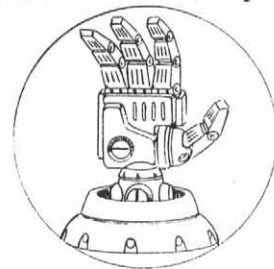

4. Sensor System Note: The X-1000 Ulti-Max has full optical systems including laser targeting, telescopic, passive night vision (light amplification), thermo-imaging, infrared, ultraviolet, and polarization. Plus all other features common to all power armor.

Sensor Bonuses: +2 to strike applicable to long-range weapon combat only, not hand to hand. +1 to dodge. Does not include VX-180 rail gun bonuses. See *Power Armor Combat Training* in the Robot Combat section of **Rifts** for other bonuses and pages 211 and 212 for standard power armor systems.

5. Rechargeable Force Field: One of the most impressive “new” developments is the mega-damage capacity force field generator that has been integrated into the overall system. The forcefield can be engaged at any time, usually at the beginning of heavy combat, thus letting the rechargeable field take the brunt of the initial attack. The two drawbacks with the force-field are that the laser cannot be fired when the field is engaged and the recharge period for an M.D.C. depleted field is 24 hours.

Depleting the 100 M.D.C. of the force field will automatically shut the field generating system down and all subsequent damage is subtracted from the body of the X-1000. A depleted force field requires a full 24 hours to regenerate to full capacity. Even minor damage (25 M.D.C. or less) will require eight (8) hours to be restored.

Triax X-2000 Dyna-Max

The Dyna-Max is the latest robot dreadnought to come from the minds at Triax Industries. The bot is a giant, towering 25 feet tall from the top of the Slammer missile launchers to the bottom of its feet. The X-2000 is specifically designed to go toe to toe with dragons, elementals, gargoyles, gurgoyles, and other giant monsters. It is quick, agile, and brimming with an incredible array of weapons for virtually every combat contingency.

The pilot usually controls the bot’s movement and weapons housed in the main arms. The co-pilot/gunner usually commands all the missiles, flamethrowers and the two rail gun appendages. The Dyna-Max comes in the colors light grey, black, crimson, medium green and camouflage.

X-2000 Dyna-Max

Exclusive to the NGR Military

German Name: das Dyna-Max, but its nickname is “der Verwuestungschoepfer (pronounced fare voost ung shoop fare). Roughly translated it means “havoc creator” or “havoc maker.”

Model Type: X-2000

Class: Ground Infantry Assault Robot with multiple weapon systems.

Crew: Two: One pilot and a co-pilot/gunner. One human-size passenger can squeeze into the storage space behind the seats.

M.D.C. by Location:

Slammer Missile Launchers (2; shoulders) — 150 each

*Shoulder Slammer Launch Tubes (4) — 50 each

*Rail Gun Arms (2, small) — 50 each

*Forearm Lasers (2) — 50 each

*Forearm Vibro-Swords (2) — 50 each

Arms (2) — 150 each

*Hands (2) — 90 each

TX-250 or VX-180 Rail Gun (1, hand-held) — 100

Legs (2) — 300 each

Feet (2) — 200 each

Leg Missile Launchers (2) — 100 each

*Leg Flamethrowers (2) — 20 each

*Leg Spotlights (2; below knees) — 5 each

Chest Searchlight (1) — 5

*Head & Sensors (1) — 75

**Main Body — 550

Reinforced Pilot’s Compartment — 150

* A single asterisk indicates small or difficult targets to hit. They can only be struck when an attacker makes a *called shot*, and even then the character is -3 to strike.

Destroying the sensor head of the bot will eliminate all forms of optical enhancement and sensory systems. The pilot must then rely on his own human vision and senses without bonuses to strike, parry, and dodge from the bot.

**Depleting the M.D.C. of the main body will shut the armor down completely, making it useless.

Speed

Running: 70 mph (112.6 km) maximum. Cruising speed is usually around 40 mph (64 km). The bot is well suited for most terrains, including underwater. It is also reasonably good at climbing rope/cables and mountains, however it cannot climb sheer walls.

Leaping: 20 feet (6 m) high or lengthwise from a stationary position; 30 feet (9 m) high or 40 feet (13.7 m) lengthwise from a running start.

Flying: Not possible.

Statistical Data

Height: 25 feet (7.6 m) overall with the Slammer launchers up; 21 feet (6.3 m) to the top of the shoulder missile launcher or 18 feet (5.4 m) to the top of the sensor head.

Width: 12 feet (3.6 m) from shoulder to shoulder

Length: 6 feet (1.8 m)

Weight: 12 tons; 14 tons fully loaded.

Physical Strength: Equal to a P.S. 50

Cargo: Small area for the pilot’s personal items.

Power System: Nuclear, average energy life is 15 years.

Black Market Cost: 40 million credits for a new, undamaged unit with all weapon systems intact.

Weapon Systems

1. Slammer Missile Launchers (2): Between the two shoulders are a pair of special missile launchers. When not in use the launchers fold down to rest on the robot’s chest. In the upright position the launchers fire a short-range concussion missile known as “Slammers.” The concussion missile is designed to knock a giant opponent or robot off of its feet and stun it for a few melees.

Primary Purpose: Anti-Gargoyles/Giants

Secondary Purpose: Ant-Personnel

Missile Type: “Slammer” concussion missiles.

Mega-Damage: 2D4 × 10 M.D. from a direct hit by the missile. More importantly, the concussion effect has a blast area of 90 feet (27.4 m) in diameter. Those within the blast radius all suffer from 1D4 × 10 M.D. and are likely (01-88%) to be knocked off their feet and stunned (01-65%).

If only knocked down, the victim of this attack will have ringing ears and a headache, but only loses one melee action/at-

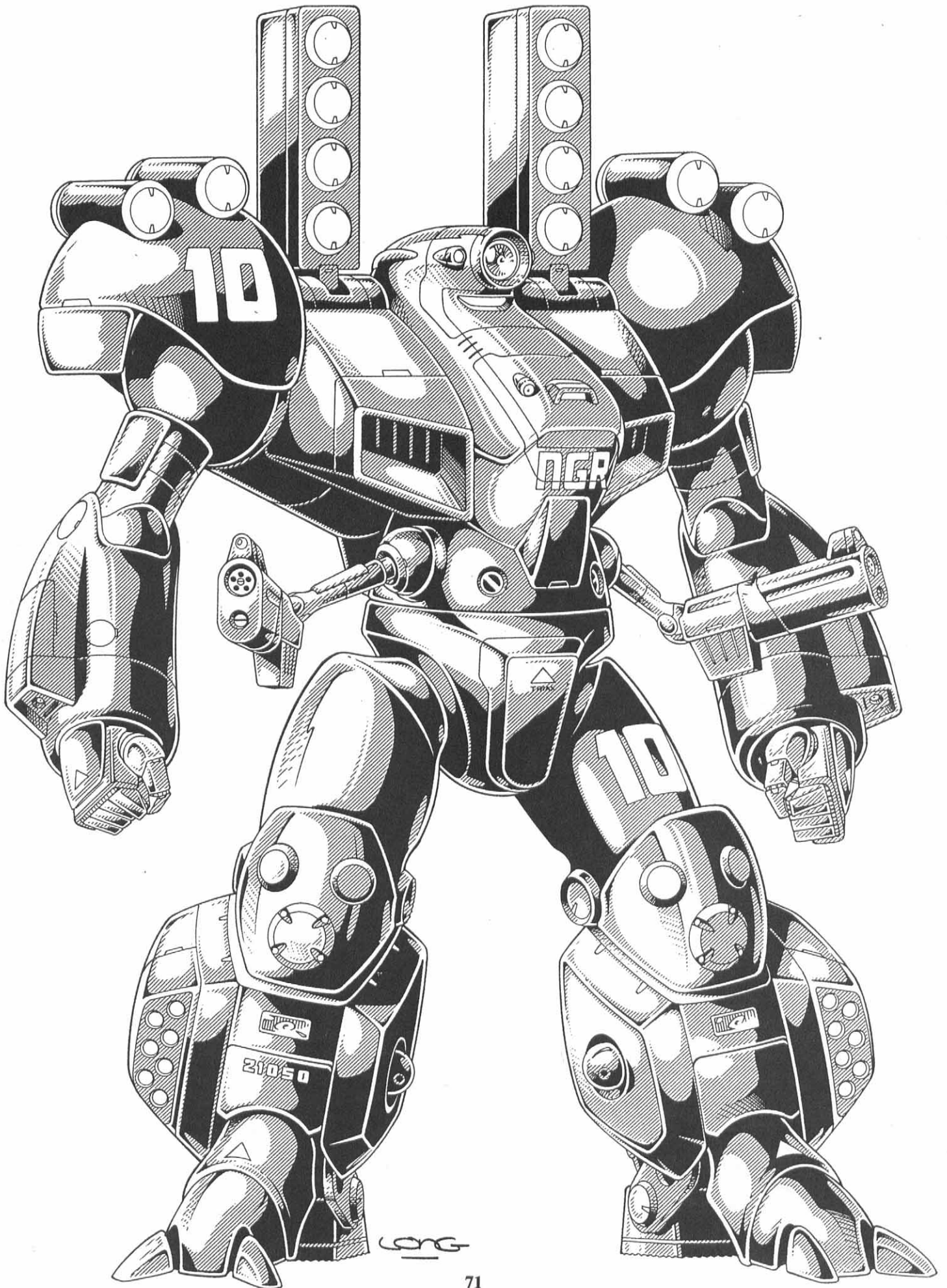

tack and initiative. A victim of a direct hit is always knocked off his feet.

If stunned, the victim is dazed, -10 to strike, parry, dodge, roll with impact or pull punch, is the last to attack (no initiative) and loses half his attacks/actions per melee round for 1D4 melee rounds! Speed is also reduced by half during this period.

Range: 6000 feet (1830 m; over a mile).

Rate of Fire: Typically, one at a time, but the missiles can be fired in volleys of two.

Payload: 8 total; 4 in each shoulder launcher.

2. Slammer Shoulder Missile Tubes (4): A pair of missile launch tubes are mounted on each shoulder. These also fire "Slammers" concussion missiles designed to knock a giant opponent off his feet and stun him for a few melees.

Primary Purpose: Anti-Gargoyles/Giants

Secondary Purpose: Ant-Personnel

Missile Type: "Slammer" concussion missiles.

Payload: 4 total; one in each launch tube.

Other Data: All other stats and information are the same as the missiles described in number one.

3. Forearm Lasers (2): Each of the forearm casings house a long-range, high-powered laser. The pilot points and shoots.

Primary Purpose: Anti-Gargoyles/Giants

Secondary Purpose: Anti-Personnel

Mega-Damage: 4D6 M.D. per single blast or 1D4 × 10 + 6 M.D. per simultaneous double blast — counts as one melee action/attack.

Maximum Effective Range: 6000 feet (1200 m)

Rate of Fire: Equal to number of combined hand to hand attacks (usually 4-8).

Payload: Effectively unlimited.

4. Forearm Vibro-Swords (2): Located in each forearm is a concealed, extendable and retractable vibro-sword. The weapon is five feet long (1.5 m).

Primary Purpose: Defense

Mega-Damage: 4D6 M.D.

Bonuses: +1 to strike and +2 to parry when engaged in hand to hand combat.

5. Rail Gun Appendages (2): A pair of tiny gun arms are located at the waist of the Dyna-Max. These are light rail guns designed for anti-personnel purposes.

Primary Purpose: Anti-Personnel

Secondary Purpose: Defense

Mega-Damage: A full damage burst fires 15 rounds and inflicts 3D6 M.D., or depleted uranium rounds can be used inflicting 4D6 M.D. per burst. Single rounds or larger bursts cannot be fired.

Rate of Fire: Equal to number of combined hand to hand attacks (usually 4-8).

Maximum Effective Range: 2000 feet (610 m)

Payload: Replaceable clip holds 300 rounds and is capable of firing 20 blasts per each arm. Additional ammunition magazines are stored in a compartment in the lower body (groin area). The larger, regular arms can easily reach down, retrieve a new magazine, pop out the old into the empty hand and slap in the new clip with the other. The spent magazine is snapped back into storage to be refilled at base. Reloading takes approximately four seconds. There are six additional magazines concealed in the storage area.

Special Feature: Independent laser targeting; +1 to strike.

6. Lower Leg Mini-Missile Launchers (2): Located on the outside of each lower leg is a mini-missile launcher.

Primary Purpose: Anti-Aircraft/Flying Monsters

Secondary Purpose: Ant-Personnel

Missile Type: Any mini-missile can be used, but standard issue is armor piercing (1D4 × 10 M.D.) or plasma (1D6 × 10). Fragmentation and/or tear gas may be used for anti-personnel operations.

Mega-Damage: Varies with missile type.

Range: Usually about a mile.

Rate of Fire: One at a time or in volleys of 2, 3 or 4.

Payload: 28 total; 14 in each leg (two rows of seven missiles are stacked in each firing compartment).

7. Flamethrowers (2): A small flamethrower turret, capable of 360 degree rotation, is located on the inside of each lower leg.

Primary Purpose: Anti-Personnel

Secondary Purpose: Vegetation removal

Mega-Damage: 1D4 M.D. per single blast or 2D4 per simultaneous double blast of napalm-like fire. Plus there is a 01-90% likelihood of setting all combustible material, including fuel, wood, dry grass, clothes and hair, on fire. The fire does an additional 1D4 M.D. per melee round and burns for a minimum of 2D4 minutes.

Maximum Effective Range: 200 feet (61 m)

Rate of Fire: Equal to number of combined hand to hand attacks (usually 4-8).

Payload: A total of 50 blasts, 25 from each leg.

8. Hand to Hand Combat: Rather than use a weapon, the pilot can engage in mega-damage hand to hand combat.

Bonuses & Damage from X-2000 Dyna-Max Combat Training:

Restrained Punch — 1D6 M.D.

Full Strength Punch — 2D6 M.D.

Power Punch — 4D6 M.D. (counts as two attacks)

Vibro-Blade — 4D6 M.D.

Crush, Pry or Tear — 1D6 M.D.

Kick — 2D6 M.D.

Leap Kick — 3D6 M.D. (counts as two attacks)

Body Flip/Throw — 1D6 M.D.

Body Block/Ram — 2D4 M.D.

Stomp — 1D6 M.D. against man-sized targets.

+2 to strike

+4 to parry

+3 to dodge

+4 to roll with impact

+4 to pull punch

+2 melee actions/attacks at level one

+1 additional melee action/attack at levels 4, 6, 9 and 12.

Note: Reduce combat bonuses by half if there is no co-pilot to serve as the gunner. Also reduce the number of attacks per melee by two.

9. Optional: TX-250 Rail Gun (1): In addition to the formidable array of weapons built into the Dyna-Max, it can also carry a TX-250 rail gun into combat. Other giant-size rail guns can be substituted.

Primary Purpose: Assault

Secondary Purpose: Defense

Weight: Gun: 250 lbs (112.5 kg). One TX-250 Ammo-Drum is another 250 lbs (112 kg). The ammo-drum hooks to the back of the bot.

Mega-Damage: A full damage burst fires 30 rounds and inflicts 6D6 M.D. A short burst of 15 rounds does 3D6 M.D. and a single round does 1D4 M.D.

Rate of Fire: Equal to number of combined hand to hand attacks (usually 4-8).

Maximum Effective Range: 6000 feet (1828 m)

Payload: The short clip holds 300 and is capable of firing 10 full damage bursts (30 rounds) or 20 half damage short bursts (15 rounds).

The 3000 round drum is capable of firing 100 full damage bursts or 200 half damage bursts (15 rounds). Reloading a drum will take about three minutes for those not trained, but a mere one minute by somebody trained in the use of power armor. A strength of 28 or higher is required to handle the drum.

Special TX-250 Feature: 1) The rail gun has its own laser targeting and radar tracking system built into the weapon itself (the large round cylinder). This can be especially useful if the sensor head is destroyed. Range: 6000 feet (1828 m). Bonuses: +1 to strike, +1 to parry and dodge.

10. Sensor Systems Note: The X-2000 has full optical systems, including laser targeting, telescopic, passive night vision (light amplification), thermo-imaging, infrared, ultraviolet, and polarization. Plus all other features common to most robots.

Triax X-2500 Black Knight

The Black Knight is one of the NGR's largest robot vehicles, towering 35 feet (10.7 m) tall. It is designed to take on the largest and most powerful monsters and enemy robots. It is used as both an infantry and defense support unit, often leading the charge into enemy lines or staying at the front to cover the strategic retreat of ground troops.

X-2500 Black Knight

Exclusive to the NGR Military

German Name: der Schwartzritter (shvarts-ritt-air)

Model Type: X-2500

Class: Ground Infantry Assault Robot with multiple weapon systems.

Crew: Two: One pilot and a co-pilot/gunner. Four human-size passengers can also be accommodated.

M.D.C. by Location:

Electro-Mace (1) — 300

*Ion Cannon (1; shoulder) — 150

Leg Missile Launchers (4) — 100 each

*Grenade Tubes (8; on feet) — 12 each

Lower Arms (2) — 200 each

Upper Arms (2) — 150 each

Shoulders (2) — 300 each

*Hands (2) — 120 each

Legs (2) — 350 each

Feet (2) — 200 each

*Ankle Searchlights (2) — 20 each

*Leg Spotlights (2; below knees) — 5 each

*Chest Searchlight (1) — 5

Head & Sensors (1) — 275

**Main Body — 750

Reinforced Pilot's Compartment (in chest) — 150

* A single asterisk indicates small or difficult targets to hit. They can only be struck when an attacker makes a *called shot*, and even then the character is -3 to strike (the sensor head is -2).

Destroying the sensor head of the bot will eliminate all forms of optical enhancement and sensory systems. The pilot must then rely on his own human vision and senses without bonuses to strike, parry, and dodge from the bot.

**Depleting the M.D.C. of the main body will shut the armor down completely, making it useless.

Speed

Running: 70 mph (112.6 km) maximum. Cruising speed is usually around 40 mph (64 km). The bot is well suited for most terrains, including underwater. It is also reasonably good at mountains, however it cannot climb sheer walls.

Leaping: 20 feet (6 m) high or lengthwise from a stationary position; 30 feet (9 m) high or 40 feet (13.7 m) lengthwise from a running start.

Flying: Not possible.

Statistical Data

Height: 35 feet (10.7 m) from the bottom of its feet to the top of the sensor head. The antenna adds another four feet (1.2 m).

Width: 23 feet (6.9 m) from shoulder to shoulder

Length: 9 feet (2.7 m)

Weight: 30 tons

Physical Strength: Equal to a P.S. 50

Cargo: Small area for the pilot's personal items.

Power System: Nuclear, average energy life is 20 years.

Black Market Cost: 45 million credits for an undamaged unit with all weapon systems intact.

Weapon Systems

1. Ion Cannon (1): Mounted next to the left shoulder is a powerful ion cannon.

Primary Purpose: Anti-Armor

Secondary Purpose: Ant-Personnel

Mega-Damage of Ion Cannon: 1D6 × 10 per blast

Cannon Maximum Effective Range: 4000 feet (1200 m)

Cannon Rate of Fire: Equal to number of combined hand to hand attacks (usually 4-8).

Cannon Payload: Effectively unlimited.

2. Forearm Lasers (2): Each of the bulky forearms have concealed lasers. The pilot points and fires.

Primary Purpose: Anti-Personnel

Mega-Damage: 3D6 M.D. per single blast or 6D6 M.D. per simultaneous double blast — counts as one melee action/attack.

Maximum Effective Range: 4000 feet (1200 m)

Rate of Fire: Equal to number of combined hand to hand attacks (usually 4-8).

Payload: Effectively unlimited.

3. Forearm Vibro-Sword (2): Located in each of the forearms is a concealed, extendable and retractable vibro-sword. The weapon is eight feet long (2.4 m).

Primary Purpose: Defense

Mega-Damage: 5D6 M.D.

Bonuses: +1 to strike and +1 to parry when engaged in hand to hand combat.

4. Electro-Mace (1): The electro-mace is a giant, hand-held weapon that can be used as a pounding blunt weapon or to fire bolts of energy. The weapon is designed with a sheathing

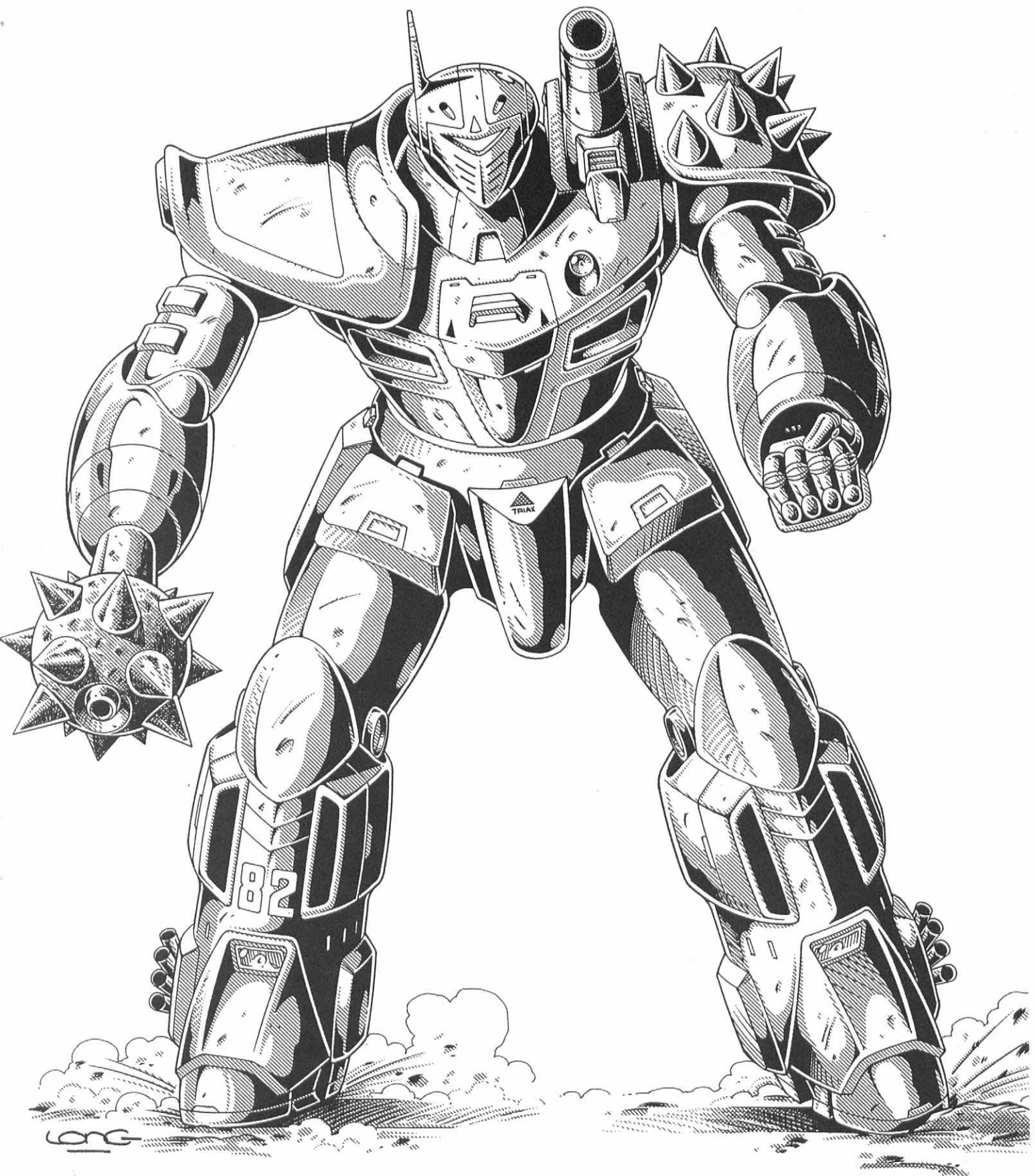

to protect the hand and forearm of the X-2500 robot and has its own power supply. Only one mace is carried into combat leaving the other hand free. This weapon is especially useful against monsters that are vulnerable to electricity.

Primary Purpose: Anti-Personnel

Mega-Damage: 1) As a blunt, pounding weapon in the hands of the Black Knight, it inflicts 4D6 M.D. per strike.

2) The mace can also be electrically charged so that one's opponent is shocked every time the mace strikes. Add 10 M.D. to blunt pounding attacks.

3) Alternatively, the mace can fire up to three powerful electrical blasts inflicting 1D4 × 10 M.D. each.

Maximum Effective Range: The electrical discharge has a maximum range of 1000 feet (305 m).

Rate of Fire: Equal to number of combined hand to hand attacks (usually 4-8). The electrical blast can only be fired three times per melee.

Payload: Effectively unlimited.

5. Lower Leg Mini-Missile Launchers (4): A pair of mini-missile launchers are located on each of the lower legs.

Primary Purpose: Anti-Aircraft/Flying Monsters

Secondary Purpose: Anti-Personnel

Missile Type: Any mini-missile can be used, but standard issue is armor piercing (1D4 × 10 M.D.) or plasma (1D6 × 10). Fragmentation and/or tear gas may be used for anti-personnel operations.

Mega-Damage: Varies with missile type.

Range: Usually about a mile.

Rate of Fire: One at a time or in volleys of 2, 3 or 4.

Payload: 56 total; 14 in each launcher (two rows of seven missiles are stacked in each firing compartment).

6. Grenade Tubes (8): On each of the feet are four rows of launch tubes. These typically fire smoke and riot control grenades/tear gas, but they can also fire explosive grenades if so desired.

Primary Purpose: Anti-Personnel

Secondary Purpose: Defensive Cover

Grenade Type: Smoke or riot control/tear gas/stun; see the Flanker for grenade descriptions. Fragmentation and/or tear gas may be used for anti-personnel operations.

Mega-Damage: Varies with type.

Maximum Range: 500 feet (152 m)

Rate of Fire: One at a time or in volleys of 2 or 4.

Payload: 32 total; 4 in each launch tube. Typically 10 smoke, 22 tear gas (or 10, 14 and 8 fragmentation).

7. Hand to Hand Combat: Rather than use a weapon, the pilot can engage in mega-damage hand to hand combat.

Bonuses & Damage from X-2500 Black Knight Combat Training:

Restrained Punch — 1D6 M.D.

Full Strength Punch — 3D6 M.D.

Power Punch — 6D6 M.D. (counts as two attacks)

Vibro-Blade — 5D6 M.D.

Electro-Mace — 4D6 M.D. (uncharged)

Electro-Mace — 4D6 + 10 M.D. (charged)

Crush, Pry or Tear — 2D6 M.D.

Kick — 3D6 M.D.

Leap Kick — 5D6 M.D. (counts as two attacks)

Body Flip/Throw — 1D6 M.D.

Body Block/Ram — 2D6 M.D.

Stomp — 2D4 M.D. against targets 10 feet (3 m) tall or smaller.

+ 2 to strike

+ 4 to parry

+ 3 to dodge

+ 2 to roll with impact

+ 2 to pull punch

+ 2 melee actions/attacks at level one

+ 1 additional melee action/attack at levels 3, 6, 10 and 14.

Note: Reduce combat bonuses by half if there is no co-pilot to serve as the gunner. Also reduce the number of attacks per melee by two.

8. Sensor Systems Note: The X-2500 has full optical systems, including laser targeting, telescopic, passive night vision (light amplification), thermo-imaging, infrared, ultraviolet, and polarization. Plus all other features common to most robots.

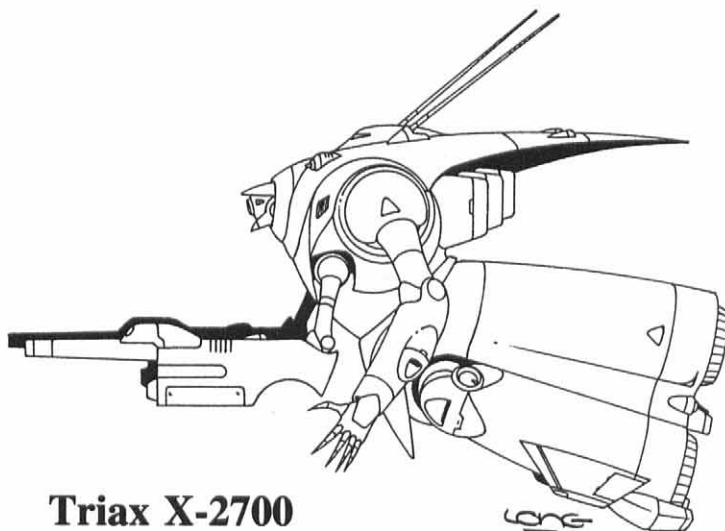

Triax X-2700 Dragonwing

The Dragonwing is the only giant infantry bot that can fly. To engage in flight, the robot leaps into the air, the legs flip back into the tail section, and the feet and rear thrusters are activated. The bot has excellent mobility. It can go from a stationary hover to a speed of Mach One in five seconds, Mach Two in eight, and can fly at tree top level or above the ground at supersonic speed, preventing radar detection and making visual identification difficult. The low flight capabilities also makes it easy for the Dragonwing to engage ground troops and to use "hide and seek" or "hit and run" tactics against them. It also has radar reflective paint and detection dampening systems that makes it invisible to most radar systems!

In the air, the Dragonwing engages gargoyles, dragons, enemy robots, aircraft, and flying terrors of all kinds. Again, its mobility is paramount to its excellence in combat. It can slow down or stop and hover to engage the enemy or to hide in a cloud bank, accelerate from a slow 20 mph (32 km) to supersonic in a few seconds, ascend or descend at a vertical angle (VTOL) and make sharp maneuvers. In addition, the Dragonwing can operate reasonably well underwater.

The impressive bot was designed specifically as a heavily armed and armored assault and defensive weapon against gargoyles and other flying menaces. They are often dispatched with X-10A Predators to engage aerial enemies. It is so versatile that

it can be used for just about any purpose. A pair of Dragonwings often escorts mobile medical stations and repair barges, assists in battlefield extraction of troops, damaged bots, and vehicles, and provides aerial troop support. Its ability to fly just above tree top or ground level combined with its invisibility on radar and VTOL features makes it perfect for reconnaissance deep behind enemy lines.

The pilot usually controls the bot's movements/flight, hand to hand combat with the big arms, chest missiles and forward machineguns. The co-pilot/gunner usually commands tail guns, and weapon arms. Common colors for the Dragonwings are light grey, sky blue, light green, medium green, camouflage, black, and crimson. Different colors can also be used to differentiate the various squadrons.

X-2700 Dragonwing

Exclusive to the NGR Military

German Name: der Drachenfluegel

(pronounced: drah ken flew gull)

Model Type: X-2700

Class: Ground & Air Infantry Assault Robot with multi-weapon systems.

Crew: One pilot and typically a co-pilot/gunner. Two human-size passengers can also be accommodated.

M.D.C. by Location:

*Tail Swivel Lasers (2; small) — 15 each

Weapon Arms (2) — 200 each

*Forward Machineguns (2; head) — 30 each

Forearm Directional Thrusters (4) — 20 each

Main Arms (2) — 200 each

*Hands (2) — 120 each

Legs (2) — 300 each

Feet Thrusters (2) — 200 each

Tail Thrusters (4) — 120 each

*Main Hatch (1; top) — 120

*Escape Hatch (1; rear) — 75

*Directional Thrusters (10, small) — 10 each

*Ankle Spotlights (2) — 10 each

*Chest Searchlights (2) — 30 each

*Head & Sensors (1) — 275

**Main Body — 525

Reinforced Pilot's Compartment (in chest) — 150

* A single asterisk indicates small or difficult targets to hit. They can only be struck when an attacker makes a *called shot*, and even then the character is -3 to strike.

Destroying the sensor head of the bot will eliminate all forms of optical enhancement and sensory systems. The pilot must then rely on his own human vision and senses without bonuses to strike, parry, and dodge from the bot.

**Depleting the M.D.C. of the main body will shut the armor down completely, making it useless.

Speed

Running: 40 mph (64 km) maximum. Cruising speed is usually around 25 mph (40 km). The bot is well suited for most terrains including outer space and underwater.

Leaping: 10 feet (3 m) high or lengthwise from a stationary position.

Jet Assisted Leaps: 100 feet (30.5 m) high or 100 feet (30.5 m) lengthwise without actually flying.

Flying: The Dragonwing has full hover and evasive flight

capabilities. It can hover in a stationary position, cruise anywhere from one to 300 mph (1.6 to 482.7 km) to Mach 2 (approximately 1340 mph/2144 km)!

Altitude: As high as 45,000 feet (13,716 m) and as low as five feet (1.5 m) above the ground.

Underwater: Maximum speed of 50 mph (80 km). Maximum depth of 600 feet (183 m).

Statistical Data

Height: 30 feet (9.1 m) from the bottom of its feet to the top of its back; the antenna adds another 10 feet (3 m).

Width: 16 feet (4.9 m) from shoulder to shoulder

Length: 27 feet (8.2 m)

Weight: 28 tons

Physical Strength: Equal to a P.S. 50

Cargo: Small area for the crew's personal items and a 5×4×4 foot storage bay (1.5×1.2×1.2 m).

Power System: Nuclear, average energy life is 20 years.

Black Market Cost: 45 million credits for an undamaged unit with all weapon systems intact.

Weapon Systems

1. Weapon Arms (2): In addition to a pair of proportionately sized arms and hands, the Dragonwing has a smaller pair of weapon arms located in the lower chest area. The long top barrel is a high-powered long-range laser. The snub-nosed port on the bottom is a short-range ion cannon.

One of the most unique elements of the weapon arms is a computer guided, synchronous firing program. This can only be performed when there is a gunner operating the weapon arms. The pilot cannot operate the arms and drive the bot at the same time. The synchronous program makes it so that both arms move identically and fire exactly at the same target at precisely the same instant. The result is a double-barrel blast that counts as one melee action/attack and inflicts double damage to the target. Of course one of the advantages of the two weapon arms is the ability to split attacks.

Laser Cannon:

Primary Purpose: Anti-Aircraft

Secondary Purpose: Anti-Personnel

Mega-Damage of the Laser Cannon: 1D4×10 per blast; double the damage if both weapon arms are synchronized to aim and fire at the same target simultaneously. Counts as one melee action/attack.

Maximum Effective Range: 6000 feet (1828 m)

Rate of Fire: Equal to the number of combined hand to hand attacks (usually 4-8).

Payload: Effectively unlimited.

Ion Cannon:

Primary Purpose: Anti-Armor

Secondary Purpose: Anti-Personnel

Mega-Damage of Ion Cannon: 1D4×10 M.D. per blast; double the damage if both weapon arms are synchronized to aim and fire at the same target simultaneously. Counts as one melee action/attack.

Damage Note: Quadruple the damage if both ion cannons and both laser cannons perform synchronous firing at close range (2000 ft/610 m). Counts as two melee actions/attacks.

Maximum Effective Range: 2000 feet (610 m)

Rate of Fire: Equal to the number of combined hand to hand attacks (usually 4-8).

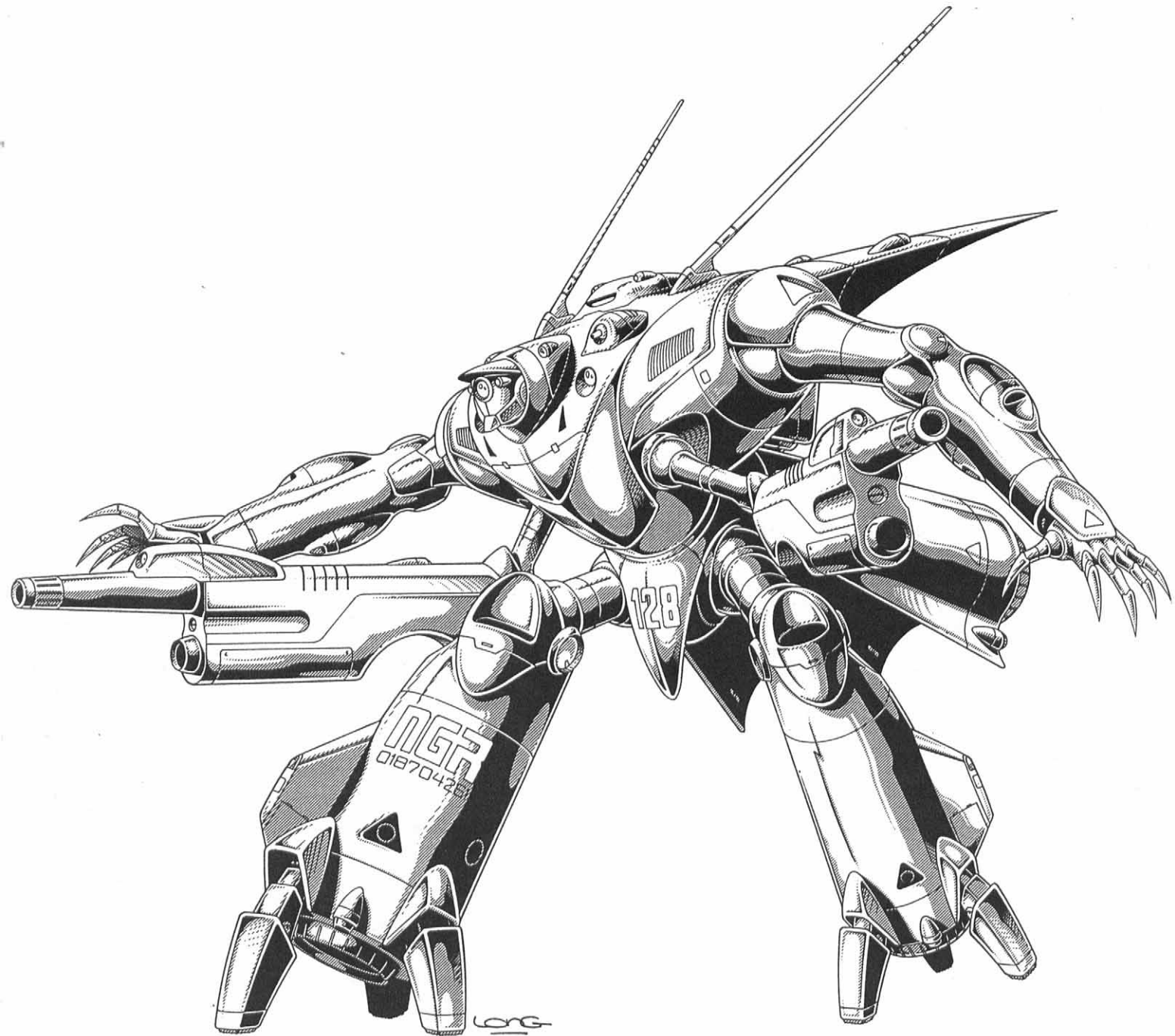

Payload: Effectively unlimited.

Special Feature: The weapon arms have their own laser targeting and short-range radar tracking system built into them (3 mile/4.8 km radar range). Laser targeting range: 6000 feet (1828 m). Bonuses: +1 to strike, +1 to parry and dodge.

2. Forward Rapid-Fire Machineguns (2): On each side between the head and the shoulders is an inconspicuous housing that contains a heavy-duty, rapid-fire machinegun. The guns typically fire depleted uranium rounds (DU-Rounds) or low radiation U-Rounds. Conventional machinegun rounds can also be used. The gun housings are fixed in a forward position, but the gun nozzles can move 60 degrees in any direction providing a comfortable strike range.

Primary Purpose: Anti-Personnel

Mega-Damage: 2D4 M.D. per burst of 20 rounds or 4D4 M.D. per simultaneous double bursts at the same target (40 rounds).

Both the single gun burst or double gun burst counts as one melee action/attack.

The damage from the low radiation U-Rounds is 2D6 M.D. or 4D6 M.D. (double burst) to supernatural monsters.

Maximum Effective Range: 4000 feet (1200 m)

Rate of Fire: Equal to the number of combined hand to hand attacks (usually 4-8).

Payload: A total of 6000 rounds; 3000 rounds per machinegun. That provides a total of 300 bursts (150 per gun).

3. Concealed Chest Missiles: A panel under the sensor head flips up to reveal 12 medium range missiles.

Primary Purpose: Anti-Aircraft

Secondary Purpose: Anti-Armor

Missile Type: Any medium range missile can be used, but standard military issue is armor piercing (2D4×10 M.D.; multi-warhead whenever possible) or plasma (2D6×10). Fragmentation may be used for anti-personnel operations.

Mega-Damage: Varies with missile type.

Range: Usually about 40+ miles (64+ km).

Rate of Fire: One at a time or in volleys of two or four.

Payload: 12 missiles

4. Tail Swivel Laser Mounts (2): A pair of small lasers are built into the top of the tail/thruster section of the bot. Each can swivel 180 degrees in all directions. They are intended as an anti-missile defense system.

Primary Purpose: Anti-Missile

Secondary Purpose: Anti-Aircraft

Mega-Damage of the Laser: 3D6 M.D. per single blast or 6D6 from a simultaneous blast from both lasers at the same target.

A double blast counts as one melee action/attack.

Maximum Effective Range: 6000 feet (1828 m)

Rate of Fire: Equal to the number of combined hand to hand attacks (usually 4-8).

Payload: Effectively unlimited.

5. Optional Electro-Mace (1): The Dragonwing can use an electro-mace identical to the one used by the Black Knight.

Primary Purpose: Anti-Personnel

Mega-Damage: 1) As a blunt, pounding weapon in the hands of the Dragonwing, it inflicts 4D6 M.D. per strike.

2) The mace can also be electrically charged so that one's opponent is shocked every time the mace strikes. Add 10 M.D. to blunt pounding attacks.

3) Alternatively, the mace can fire up to three powerful electrical blasts inflicting 1D4 × 10 M.D. each.

Maximum Effective Range: The electrical blast has a maximum range of 1000 feet (305 m).

Rate of Fire: Equal to the number of combined hand to hand attacks (usually 4-8). The electrical blast can only be fired three times per melee.

Payload: Effectively unlimited.

6. Optional: Slammer Concussion Bombs: 20 concussion bombs can be fitted onto the lower body and/or legs of the X-2700 Dragonwing. The bombs have the same effect as the Slammer missiles, except they are "dropped" from the air and explode on impact.

Primary Purpose: Anti-Gargoyles/Giants

Secondary Purpose: Anti-Personnel

Weapon Type: "Slammer" concussion bombs

Mega-Damage: 1D4 × 10 M.D. to the entire 90 feet (27.4 m) in diameter blast radius. Those within the blast area are also likely to be knocked off their feet (01-88%) and stunned (01-65%).

If only knocked down, the victim of this attack will have ringing ears and a headache, but only loses one melee action/attack and initiative. A victim of a direct hit is always knocked off his feet.

If stunned, the victim is dazed, - 10 to strike, parry, dodge, roll with impact or pull punch, is the last to attack (no initiative) and loses half his attacks/actions per melee round for 1D4 melee rounds! Speed is also reduced by half during this period.

Range: 6000 feet (1830 m; over a mile).

Rate of Fire: Typically, one at a time, but the bombs can be fired in clusters of two to ten.

Payload: 20 total.

7. Hand to Hand Combat: Rather than use a weapon, the pilot can engage in mega-damage hand to hand combat.

Bonuses & Damage from X-2700 Dragonwing Combat Training: Roughly the same as the Black Knight.

Restrained Punch — 1D6 M.D.

Full Strength Punch — 3D6 M.D.

Power Punch — 6D6 M.D. (counts as two attacks)

Crush, Pry or Tear — 2D6 M.D.

Kick — 3D6 M.D.

Leap Kick — 5D6 M.D. (counts as two attacks)

Thruster Blast from Feet — 2D6 M.D.

Body Flip/Throw — 1D6 M.D.

Body Block/Ram — 2D6 M.D. (running)

Flying Body Block/Ram — 5D6 at 100 mph (160 km), 1D6 × 10 at 200 mph (320 km), 2D4 × 10 at 300 mph (480 km), 4D4 × 10 at 500 mph (804 km), 4D6 × 10 at Mach One, 1D4 × 100 at Mach 2, but at Mach speed the Dragonwing also suffers half the amount of damage that it inflicts.

Electro-Mace — 4D6 M.D. (uncharged)

Electro-Mace — 4D6 + 10 M.D. (charged)

Stomp — 2D4 M.D. against targets 10 feet (3 m) tall or smaller.

+ 2 to strike

+ 4 to parry

+ 3 to dodge on the ground

or + 5 to dodge flying at Mach 1 +

+ 2 to roll with impact

+ 2 to pull punch

+ 2 melee actions/attacks at level one

+ 1 additional melee action/attack at levels 3, 6, 10 and 14.

Note: Reduce combat bonuses by half if there is no co-pilot to serve as the gunner. Also reduce the number of attacks per melee by two.

8. Sensor Systems & Features of Note: 1) The X-2700 has full optical systems, including laser targeting, telescopic, passive night vision (light amplification), thermo-imaging, infrared, ultraviolet, and polarization. Plus all other features common to most robots.

2) Radar reflective paint. This special paint makes the Dragonwing invisible to most radar systems. The most powerful and sophisticated radar detection systems may get an occasional "blip" or shadow, but only for a second and then it's gone. Similarly, battle damaged Dragonwings (30% to 60% of its main body M.D.C. is gone) are less radar proof and will fade in and out of radar monitors every few minutes. This may be enough for the enemy to project the robot's course and target/destination. When the bot has lost 65% or more of its main body (and paint) it is completely visible on radar! Flying low, under the radar is the only way to avoid radar detection, but it is then susceptible to visual tracking and ground attack.

3) Triax has a handful of "Glitter Wing" prototypes. These are designated as X-2710 Dragonwings. These experimental bots do not have the radar blocking paint but utilize laser reflective body armor the same as the T-550 Glitter Boy. Although an interesting modification, the Glitter Wing is not as versatile as the radar invisible X-2700 and is not likely to be produced in any large numbers.

Triax X-5000 Devastator

The Devastator is the largest infantry robot Triax has ever created. It stands 50 feet (15.2 m) tall and is brimming with heavy armaments. The robot is imposing and commands an incredible amount of firepower. It is a walking artillery unit with two long-range cannons and over a hundred missiles! As such, the X-5000 functions admirably well, with dozens or hundreds of smaller bots, borgs, power armor troops and foot soldiers rallying around it. As the troops press forward, the Devastator offers them support by dispersing the enemy with its arsenal of weapons, knocking out enemy artillery, armored units, and targeting flying gargoyles, dragons, and aircraft. In this capacity, the robot becomes the cornerstone of a mobile assault force with offensive and defensive capabilities. However, as a single assault unit, the X-5000 is vulnerable to enemies.

Like the Pre-Rifts movie monster, Godzilla, the massive robot can plod into an enemy stronghold, topple buildings, squash vehicles under its feet, and release incredibly devastating salvos of missiles or energy blasts. If the X-5000 Devastator has a serious weakness, it lies in its comparatively slow reflexes and speed. Smaller more maneuverable opponents, including helicopters, jet fighter planes, robots, borgs, gargoyles, dragons and others, can fly or run rings around it. Furthermore, small, fast assailants fighting close to the giant bot have little to fear from its most powerful, *long-range* weapons, and need only worry about the belly gun and mini-missiles. Hand to hand combat is really effective only against very large opponents and for smashing buildings. Unless the Devastator has armored troops to protect it from close combat, the robot is in danger of being overrun by the enemy.

During one recent battle behind enemy lines, the gargoyle legions broke through an infantry stronghold. Scores of gurgoyles swarmed over a Devastator like angry ants. With a sweep of its mighty arm, the bot would knock away four or five attackers, only to have three or four others take their place. The mini-missiles were a successful deterrent until they ran out. The belly gun cut down a dozen attackers before it was disabled. Still, the mechanical behemoth withstood incredible damage and held the enemy's main force back the 15 minutes the retreating humans needed to escape. During those long minutes, it was estimated that the Devastator destroyed or disabled three giant gargoyle bots, five baalrog demons, two dozen gargoyles and over 100 gurgoyles! The crew was rescued by two squadrons of Dragonwings and picked up by a Lightning VTOL combat jet. Moments after the crew was extracted, the self-destruct mechanism turned the bot and its weapons into scrap metal.

X-5000 Devastator

Exclusive to the NGR Military

German Name: die Verwuestung

(pronounced: fare-voost-ung)

Model Type: X-5000

Class: Ground Infantry Assault Robot with multiple weapon systems.

Crew: Two: One pilot and a co-pilot/gunner. A communications officer and/or intelligence officer is optional. The giant bot can accommodate as many as six additional human-size passengers comfortably and contains four man-size suits of body armor as part of its armaments; typically the T-31 Super Trooper or X-10A Predator, or basic X-535 Jager.

M.D.C. by Location:

Super Laser Cannon (1; handheld) — 250

Super Ion Cannon (1; back) — 250

Long-range Missile Launchers (4; lower legs) — 200 each

Medium Range Missile Launchers (2; forearm) — 100 each

*Mini-Missile Launchers (2; head fins) — 100 each

*Belly Gun (1) — 100

Cooling Pylons (4) — 150 each

Lower Arms (2) — 200 each

Upper Arms (2) — 200 each

Shoulders (2) — 350 each

Hands (2) — 150 each

Legs (2) — 500 each

Feet (2) — 250 each

*Leg Searchlights (2) — 25 each

*Leg Spotlights (2; below knees) — 5 each

*Head Searchlight (1; forehead) — 10

Main Hatch (1; near head) — 150

Emergency Escape Hatches (2) — 10 each

Head & Sensors (1) — 375

**Main Body — 1500

Reinforced Pilot's Compartment (in chest) — 150

* A single asterisk indicates small or difficult targets to hit. They can only be struck when an attacker makes a *called shot*, and even then the character is -3 to strike (the sensor head is -2).

Destroying the sensor head of the bot will eliminate all forms of optical enhancement and sensory systems. The pilot must then rely on his own human vision and senses without bonuses to strike, parry, and dodge from the bot.

**Depleting the M.D.C. of the main body will shut the armor down completely, making it useless.

Speed

Running: 40 mph (64 km) maximum. Cruising speed is usually around 20 mph (32 km). Suitable for most terrains including outer space and underwater.

Leaping: Not possible.

Flying: Not possible.

Statistical Data

Height: 50 feet (15.2 m) from the bottom of its feet to the top of the sensor head. When in the upward stowed position, the ion cannon adds another 20 feet (6 m).

Width: 30 feet (9 m) from shoulder to shoulder

Length: 25 feet (7.6 m)

Weight: 150 tons

Physical Strength: Equal to a P.S. 60

Cargo: Lockers for the crew, power armor storage bay and an 8 × 8 × 8 foot (2.4 m) storage bay.

Power System: Nuclear, average energy life is 20 years.

Black Market Cost: 150 million credits!

Weapon Systems

The strength of the X-5000 Devastator lies in its super-destructive armaments and thick protective armor.

1. TX-5000 Super Laser Cannon (1): The huge rifle-like weapon is a giant long-range laser cannon.

Primary Purpose: Anti-Armor

Secondary Purpose: Anti-Aircraft/Gargoyles

Mega-Damage: $1D6 \times 10$ M.D. per single full power blast. Or $4D6$ M.D. low power blasts.

Maximum Effective Range: 8000 feet (2438 m)

Rate of Fire: Equal to the number of combined hand to hand attacks (usually 4-8).

Payload: 50 full strength blasts. Low power blasts can be fired indefinitely.

Special Feature: Independent and coordinated targeting: +2 to strike.

2. TX-5001 Super Ion Cannon (1): Mounted on the back, this big gun swings down, and over the right shoulder to fire. It can fire in any position, including while locked in the stowed position.

Primary Purpose: Anti-Armor

Secondary Purpose: Anti-Personnel

Mega-Damage of Ion Cannon: $2D4 \times 10$ M.D. per blast

Cannon Maximum Effective Range: 4000 feet (1200 m)

Cannon Rate of Fire: Equal to the number of combined hand to hand attacks (usually 4-8).

Cannon Payload: Effectively unlimited.

Special Feature: Independent and coordinated targeting: +1 to strike.

3. Long-Range Missile Launchers (4): A pair of long-range missile launchers are located near the knees of each leg.

Primary Purpose: Anti-Armor

Secondary Purpose: Anti-Aircraft

Missile Type: Any long-range missile can be used, but standard military issue is proton torpedoes ($4D6 \times 10$ M.D.), nuclear multi-warhead ($4D6 \times 10$ M.D.) or heavy plasma ($3D6 \times 10$ M.D.). All are smart bombs and are +5 to strike. Other missiles may be used.

Mega-Damage: Varies with missile type.

Range: Usually about a 1000+ miles (1640+ km).

Rate of Fire: One at a time or in volleys of two or four.

Payload: 32 missiles total; eight in each launcher.



4. Medium Range Missile Launchers (2): Eight medium-range missiles are housed in a launcher on each forearm.

Primary Purpose: Anti-Armor

Secondary Purpose: Anti-Aircraft

Missile Type: Any medium range missile can be used, but standard military issue is armor piercing ($2D4 \times 10$ M.D.; multi-warhead whenever possible) or plasma ($2D6 \times 10$). All missiles are +3 to strike.

Mega-Damage: Varies with missile type.

Range: Usually about 40+ miles (64+ km).

Rate of Fire: One at a time or in volleys of two or four.

Payload: 16 missiles; eight in each launcher.

5. Mini-Missile Launchers (2): On each side of the head is a fin-like appendage. From the front of these appendages, mini-missile are launched.

Primary Purpose: Anti-Missile and Flying Monsters

Secondary Purpose: Anti-Personnel

Missile Type: Any mini-missile can be used, but standard issue is armor piercing ($1D4 \times 10$ M.D.) or plasma ($1D6 \times 10$). Fragmentation and/or tear gas may be used for anti-personnel operations.

Mega-Damage: Varies with missile type.

Range: Usually about a mile.

Rate of Fire: One at a time or in volleys of 2, 3 or 4.

Payload: 60 total; 30 in each launcher compartment.

6. Ion Belly Gun Turret: The double-barreled ion blaster is designed to counter ground troops and can rotate 90 degrees up and down. The turret can fire one of its guns or both simultaneously. Also note that the entire upper torso section of the X-5000 Devastator can rotate 360 degrees, which means it can turn completely around without having to move its feet!

Primary Purpose: Assault

Secondary Purpose: Defense

Mega-Damage: $4D6$ M.D. per single blast or $1D4 \times 10$ per dual simultaneous blast.

Rate of Fire: Equal to number of combined hand to hand attacks (usually 4-6).

Maximum Effective Range: 4000 feet (1200 m)

Payload: Effectively unlimited.

7. Hand to Hand Combat: Rather than use a weapon, the pilot can engage in mega-damage hand to hand combat.

Bonuses & Damage from the X-5000 Devastator Combat Training:

Restrained Punch — $2D6$ M.D.

Full Strength Punch — $1D6 \times 10$ M.D.

Power Punch — $2D6 \times 10$ M.D. (counts as two attacks)

Crush, Pry or Tear — $1D6 \times 10$ M.D.

Kick — $1D6 \times 10$ M.D.

Leap Kick — Not possible

Body Flip/Throw — $4D6$ M.D.

Body Block/Ram — $1D6 \times 10$ M.D.

Stomp — $6D6$ M.D. against targets 15 feet (4.5 m) tall or smaller.

+1 to strike (in addition to weapon bonuses)

+1 to parry

No dodge

No roll with impact

No pull punch

+1 additional melee action/attack at levels 2, 6, 10 and 14.

Note: Reduce combat bonuses by half if there is no co-pilot to serve as the gunner. Also reduce the number of attack per melee by two.

8. Sensor Systems Note: The X-5000 has ALL the most advanced optic, sensory and radio equipment, plus all other features common to most robots.

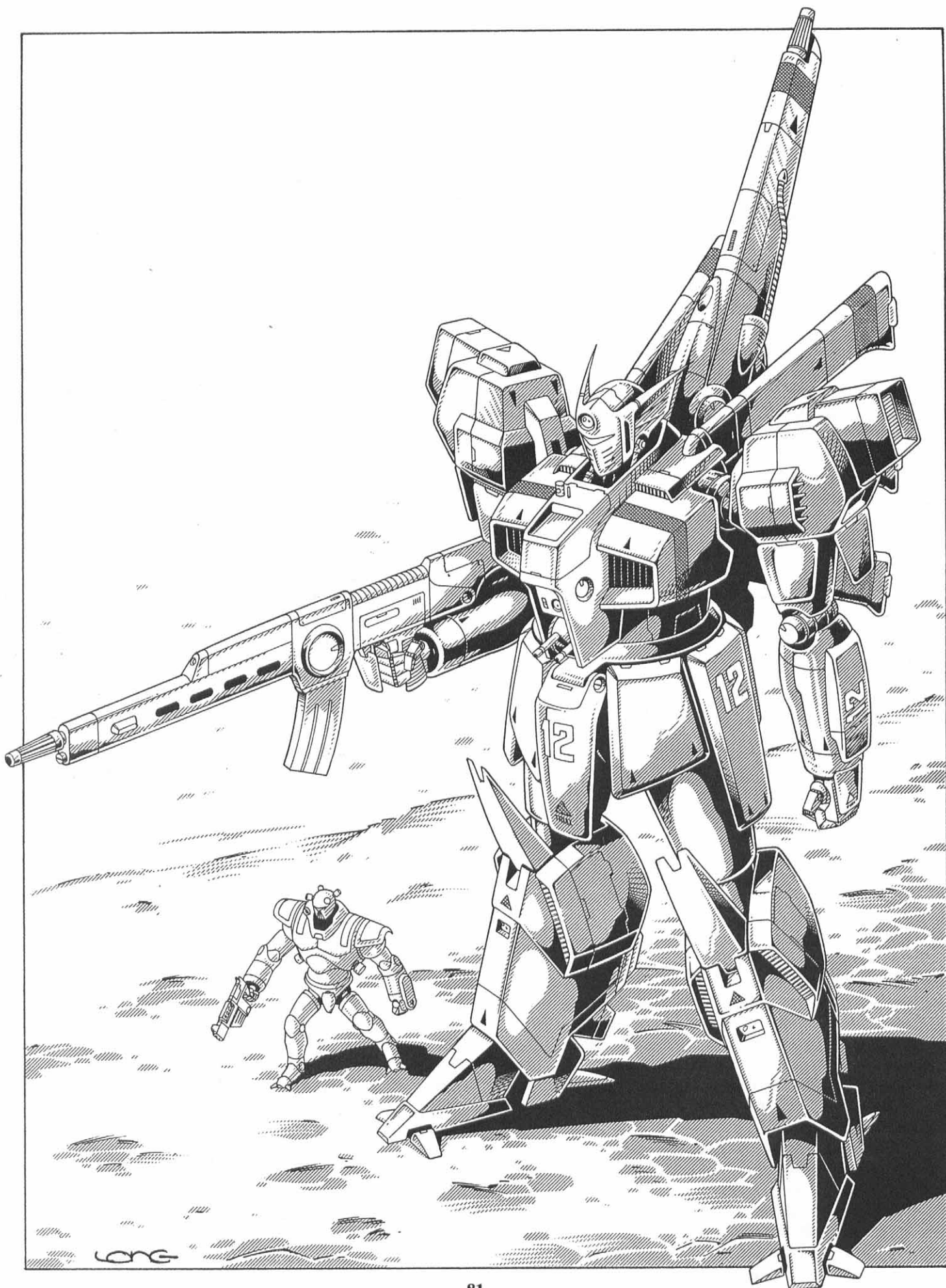

DV-Series Robot Drones

The DV-Series of robots are unmanned machines driven by an artificial intelligence. As a rule, these drones are used as front line assault troops, perimeter guards, laborers and defenders. As good as the programs for these bots are, they do not possess the faculties of the human mind. The bots follow direct orders well, but do not have human reasoning to make subjective decisions. For this reason, the technicians at Triax continue to develop better robot brains and programs, and are even engaging in mind transfer experiments to place a human mind inside a robot.

Unmanned robots give the NGR a quantum leap in their battle against the enemy. In addition to increasing the size of the armed forces, robots never tire, are not frightened or confused and never question orders. Against an inhuman enemy, robots are remorseless destroyers of considerable strength and endurance. They are especially useful for missions deep in enemy territory where it is too dangerous to send humans. DV-40 Hunter/Killers and DV-12 Dyna-bots are sent on reconnaissance and seek and destroy missions, while the DV-15 Sentry-bots help to protect the Army's defenses. Massive infantry assaults will have a front line of DV-40s and DV-12s to soften the enemy and reduce the number of human casualties.

Robot Drones

DV-12 Dyna-bot	EIR 15 Gargoyle (manned)
DV-15 Sentry Bot	EIR 20 Gurgoyl Drone
DV-40 Hunter/Killer Drone	EIR 30 Gargoylite
EIR 10 Gargoyle Drone	EIR 50 Gurgoyl Android

Triax DV-12 Dyna-Bot

Human life is a precious commodity that cannot be carelessly or callously discarded in war. The DV-12 Dyna-bot was created to function as an expendable substitute for human troops. The DV-12, the DV-15 and DV-40 are the most advanced in a long series of man-size robots and represent decades of technological development.

Dyna-bots are used by the New German Republic as laborers, defenders/guards, infantry troops, and exterminators. As automated hunter/killers, they are sent on long journeys throughout Europe for the express purpose of locating and terminating gargoyles, brodkil, simvan, gene-splicers, dragons and other enemy life forms. Literally millions of DV-12 Dyna-bots and DV-40 Hunter/Killers have been sent into the Monster Zones to purge the land. Some travel in small squads or platoons, while others roam the countryside alone or in pairs. They can also accompany human troops as front-line infantry troops, defenders and as a tireless work force.

The orientation of the DV-12 Dyna-bots are divided into either combat or labor. The distinction is simple, combat drones recognize and fight the enemy upon sight. Labor drones concentrate on work, have only rudimentary combat programming and engage the enemy only when ordered to do so. However, it is a very simple matter to convert a DV-12 labor bot into a combat

unit in less than one minute. It is simply a matter of switching a couple of computer boards.

Triax Dyna-Bot

A part of the NGR Military

Model Type: DV-12

Class: Fully Automated Self-Sufficient Assault Robot

Crew: None; artificial intelligence

M.D.C. by Location:

Hands (2) — 15 each

Arms (2) — 40 each

Laser Fingers (2; one on each hand) — 2 each

TX-50 Rail Gun (1) — 20

Legs (2) — 60 each

*Head — 40

**Main Body — 130

* Destroying the head of the robot will eliminate all optics and sensory systems. In most cases the robot shuts down as a safety feature. However, in some cases, about one in ten, the robot continues to fight, blasting blindly until its ammunition is expended, and even then it will continue to grope around, lashing out and hitting anything it touches. Under these conditions, the robot enjoys no combat bonuses to strike, parry, or dodge! **Note:** The head is a small and difficult target to hit, especially on a moving target. Thus, it can only be hit when a character makes a *called shot* and even then the attacker is -2 to strike.

Depleting the M.D.C. of the main body will effectively destroy the bot, shutting it down completely and making it useless. **Note: Additional body armor or power armor cannot be worn by dyna-bots.

Speed

Running: 120 mph (192 km) maximum. Note that the act of running does NOT tire the robot and speed can be maintained indefinitely.

Leaping: The robot legs, although strong, are not designed for leaping. Leaps are limited to approximately 12 feet (3.7 m) high or lengthwise. A running leap at speeds in excess of 60 mph (96 km) will enable the bot to leap an additional 2D6 + 6 yards/meters.

Flying: None, without the addition of a T-100 Eagle jet pack.

Range: The nuclear power pack gives the dyna-bot approximately five years of life even under the most strenuous conditions.

Statistical Data

Height: 7 feet, 4 inches (2.2 m)

Width: 3 feet (0.9 m)

Length: 3 feet (0.9 m)

Weight: 500 lbs (225 kg)

Physical Strength: Equal to a P.S. 40

Cargo: None

Power System: Nuclear, average dyna-bot energy life is five (5) years.

Black Market Cost: Although Triax Industries has been authorized to use DV-12 Dyna-bots in a civilian, work and defense capacity, the Dyna-bots are not available to the mass market. Only a limited number of bots have been sold overseas in the Americas.

The black market will sell the bots for three million credits new and undamaged, complete with the combat program, assault rifle and bot weapon systems. Very poor availability. The combat

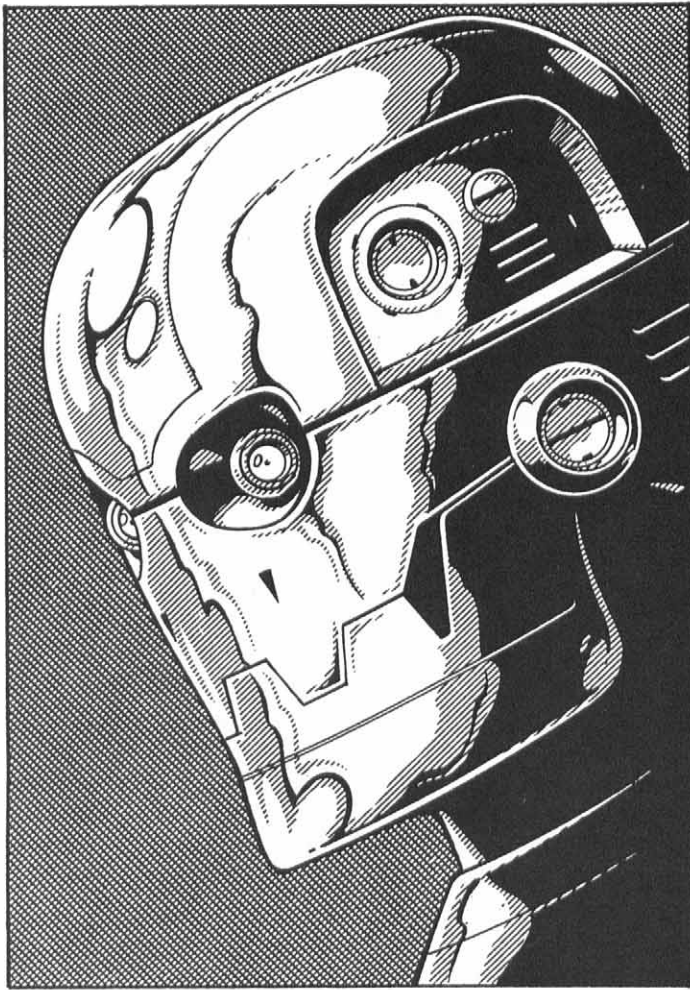

version without weapons and programming costs two and a half million credits. Note that the labor program makes the DV-12 slow and docile; reduce maximum speed, attacks/actions per melee, and all combat type bonuses by half. A bootleg DV-12 combat program costs 500,000 credits.

Weapon Systems

The specific weapons used by the DV-12 can vary. The following is the standard DV-12 commonly used in the NGR military (the North American bot comes standard with the TX-30 ion pulse rifle).

- 1. TX-50 Rail Gun (1 or 2):** This is the standard weapon for the DV-12 Dyna-bot. The weapon is a light, all-purpose weapon used by human-sized bots, borgs and power armor troops. If desired, the robot can use one in both hands, although only one is standard issue; two require authorization. The TX-50 rail gun can use what is called a short clip with 200 rounds (10 bursts), light drum with 600 rounds (30 bursts), or a heavy, belt feed drum containing 2000 rounds (100 bursts). The latter is typically reserved for robots and cyborgs. Other rail guns can be substituted.

Primary Purpose: Assault

Secondary Purpose: Defense

Weight: Gun: 60 lbs (27 kg), short clip: 10 pounds (4.5 kg), light ammo-drum: 30 pounds (13 kg) or a heavy ammo-drum: 100 lbs (45 kg). Ammo-drums are hooked to the back of body armor or a housing on the back of bots.

Mega-Damage: A full damage burst fires 20 rounds and inflicts 5D6 M.D.; a single round does 1D4 M.D.

Rate of Fire: Equal to the bot's hand to hand attacks (usually 6).

Maximum Effective Range: 4000 feet (1200 m)

Payload: The short clip holds 200 rounds and is capable of firing ten full damage bursts (20 rounds). The light drum holds 600 rounds and can fire 30 bursts. The 2000 round drum is capable of firing 100 full damage bursts (20 rounds each).

Reloading a drum will take about three minutes for those not trained, but a mere 30 seconds by a capable field mechanic. A strength of 24 or higher is required to handle the drum.

- 2. Laser finger guns (2):** One of the fingers on each hand is a small laser that can be used as a tool or as a weapon.

Primary Purpose: Assault

Mega-Damage: Three settings: 1D6 × 10 S.D.C., or 1D6 M.D., or 2D6 M.D. per finger. The two fingers can be fired simultaneously at the same target (double damage) but only on an aimed shot.

Rate of Fire: Equal to the total number of hand to hand attacks.

Effective Range: 2000 feet (610 m)

Payload: Effectively unlimited.

Bonus: +1 to strike.

- 3. Concealed Particle Beam Rod (light):** A particle beam weapon concealed in one of the legs and powered by the bot's nuclear battery.

Primary Purpose: Assault

Weight: 15 lbs (7 kg)

Mega-Damage: 5D6 + 6 M.D.

Range: 1600 feet (488 m)

Rate of Attack: Equal to the number of hand to hand melee attacks.

Payload: Effectively unlimited.

- 4. Chemical spray from the mouth:** Inside the mouth is a spray unit that can release a variety of toxic mists (same as bionics, **Rifts RPG** page 240). Combat models are usually equipped with tranquilizer/sleep spray or tear gas. Total of 60 doses.
- 5. Hand to Hand Combat:** Rather than use a weapon, the dyna-bot can engage in mega-damage hand to hand combat using its fists or vibro-blades. *Six (6) attacks per melee!* Equal to Hand to Hand: Martial Arts.

Damage:

Restrained Punch — 2D6 + 25 S.D.C.

Full Strength Punch — 2D6 M.D.

Power Punch — 4D6 + 4 M.D.

Head Butt — 1D6 M.D.

Kick — 1D8 M.D.

Jump Kick/Leap Attack — Double damage (2D8 M.D.)

Judo style throw/flip — 1D4 M.D.

Critical Strike on a natural roll of 19 or 20.

Combat Bonuses: Include all bonuses from combat programming, robot abilities and sensors. +4 on initiative, +1 to strike with a rail gun, +3 to strike with an automatic rifle, energy pistol, or energy rifle (see W.P. skills), +4 to strike on an aimed shot, +6 to strike in hand to hand combat (punch, kick, etc.), +7 to parry with fists/arms/foot, +8 to parry with handheld weapon (knife, sword, etc.), +8 to dodge, +6 to parry and dodge attacks from behind (motion and sound detectors), +4 to roll with impact or fall, +6 to pull punch. Impervious to poison, gas, and biological agents,

as well as psionic and magic mind control, charms, bio-manipulation, and S.D.C. attacks.

6. **Optional TX-30 Ion Pulse Rifle, TX-500 Borg Rail Gun**, or any type of assault rifle or light rail gun can be used in place of the standard issue weapons.

7. **Combat Skill Program:** W.P. sword, W.P. knife, W.P. automatic rifle, W.P. energy pistol, W.P. energy rifle, W.P. heavy weapons/rail gun, and W.P. paired weapons. The paired weapons skill means the bot can manipulate handheld tools or weapons with both hands and in simultaneous coordinated attack (double damage, counts as one attack/melee action, or attack with one and parry with the other). Hand to Hand: Martial Arts equal to 10th level skill (See number 5 for bonuses). The bots are programmed to recognize acts of aggression and to respond appropriately. It is interesting to note that deadly force is the response to most hostility.

Other skills from the combat program: Pilot hovercraft 96%, pilot jet pack 80%, pilot boat 80%, radio: basic 96%, intelligence 90%, land navigation 90%, track (humanoids) 80%, prowl 50% (includes penalties), gymnastics, and climb 96%/86% (can climb 5 × faster than the average humanoid). Languages include: Euro, American, Gobblely, and Techno-can, each at 96%; basic math 96%.

Programming and memory enables the bot to identify all known enemy forces of the New German Republic. Includes the identification of 5000 different enemy targets, including specific races, monsters, aliens, non-human features and powers, insignia, uniforms, enemy robots, vehicle designs, and notorious enemies of the Republic. Combat programming directs the actions and reactions to encounters and attacks. The dyna-bot is fast, deadly, often silent, and cunning.

Alternate Labor Program: Speed, the number of attacks/actions per melee round and all bonuses are all reduced by half! Common skills: Radio: basic 96%, cooking 90%, preserve food 90%, sewing 90%, first aid 90%, basic electronics 90%, automotive mechanics 50% (but make excellent assistants), demolition and disposal 90%, pilot hover craft 90%, and pilot truck 90%. Languages include: Euro, American, Euro, Techno-can, each at 96%; basic math 96%. NO hand to hand combat or weapon proficiencies. The bot can only use its fists or particle beam rod when under direct orders to engage the enemy and then will only attack obviously monstrous antagonists, not humans or human-like D-bees. **Note:** As a laborer, the bots never tire, can carry a ton and lift two tons!

8. Sensor Systems of Note

Optics: The Dyna-bots have full optical systems, including the visible light spectrum, infrared, ultraviolet, and polarization, passive night vision (light amplification), thermo-imaging, laser targeting, and telescopic. *Telescopic optics* function like built-in binoculars with a range of about two miles (3.2 km). All the other optic systems have a range of about 3000 feet (914 m).

Amplified Hearing: Can hear sounds as quiet as 10 decibels as far away as 500 feet (152 m). Can also hear in the ultrasonic range of high frequency sound. The computer is programmed to recognize 50,000 different sounds, from bird chirps to the sound of a car engine or hum of an energy rifle. Adds to bonuses to strike, parry and dodge (see bonuses).

Motion Detector: 200 foot radius (61 m), adds to ability to parry and dodge (see bonuses).

Radio Communication: Medium-range, wide-band directional radio. Range: 40 miles (64 km). The bot communicates in the languages of Techno-can, Euro and American via voice synthesizers or direct radio transmission. The bot can identify several other languages, including traditional German, Gobblely, Dragonese, Faerie Speak and Gargoyle, but cannot understand or communicate in them. It can also eavesdrop on enemy transmissions and track transmissions (60% success level) to their source. Range: 10 miles (16 km).

Speech: Full synthesized voice system and loudspeaker are standard. The bot can simulate questions and dialogue about as well as any basic computer and give a verbal response. However, the voice is extremely mechanical and inhuman sounding. This is deliberate to prevent soldiers from getting attached/fond of these machines. **Note:** The Dyna-bot is programmed not to verbally respond to the enemy in any way and will fight till it or the enemy is destroyed. Robots are never given strategic or tactical information.

Triax DV-15 Sentry-Bot

In many respects, the DV-15 Sentry-bot is nothing more than a modified DV-12 Dyna-bot. The main differences are that the DV-15 has heavier armor, is a bit slower and has a multi-sensor crown built into its head.

Sentry-bots are used by the military of the New German Republic as guards and defenders, occasionally for reconnaissance; rarely as infantry troops. The orientation of the DV-15 Sentry-bot is combat and defense. Like all the DV-Series robots, only Triax has the right to use the bot outside of the military.

A robot makes the perfect sentry. It is constantly alert, never tires, and cannot be bribed. In addition, the mechanical creation is not susceptible to gases, drugs, or physical discomfort. If the bot uses tear gas or smoke grenades it can walk right into the cloud of irritant to apprehend its attacker or escaping prisoners. The bots superhuman strength and speed makes them more than a match for normal humans or D-bees and tough enough to engage juicers, crazies, borgs or power armored assailants. The number of Sentry-bots assigned to a job will vary on the elements involved. They are used to guard prisoners and prisons, may be assigned to patrol/guard military grounds, barracks, supply stations, communication stations, encampments, vehicles, equipment and strategic locations. They may also be assigned to guard a particular individual and escort him wherever he goes.

Triax Sentry-Bot

A part of the NGR Military

Model Type: DV-15

Class: Fully Automated Self-Sufficient Assault Robot

Crew: None; artificial intelligence

M.D.C. by Location:

TX-30 Ion Pulse Rifle (1) — 5

Searchlight (1; neck area) — 5

Laser Fingers (2; one on each hand) — 2 each

Hands (2) — 15 each

Arms (2) — 45 each

Legs (2) — 70 each

*Head — 50

**Main Body — 160

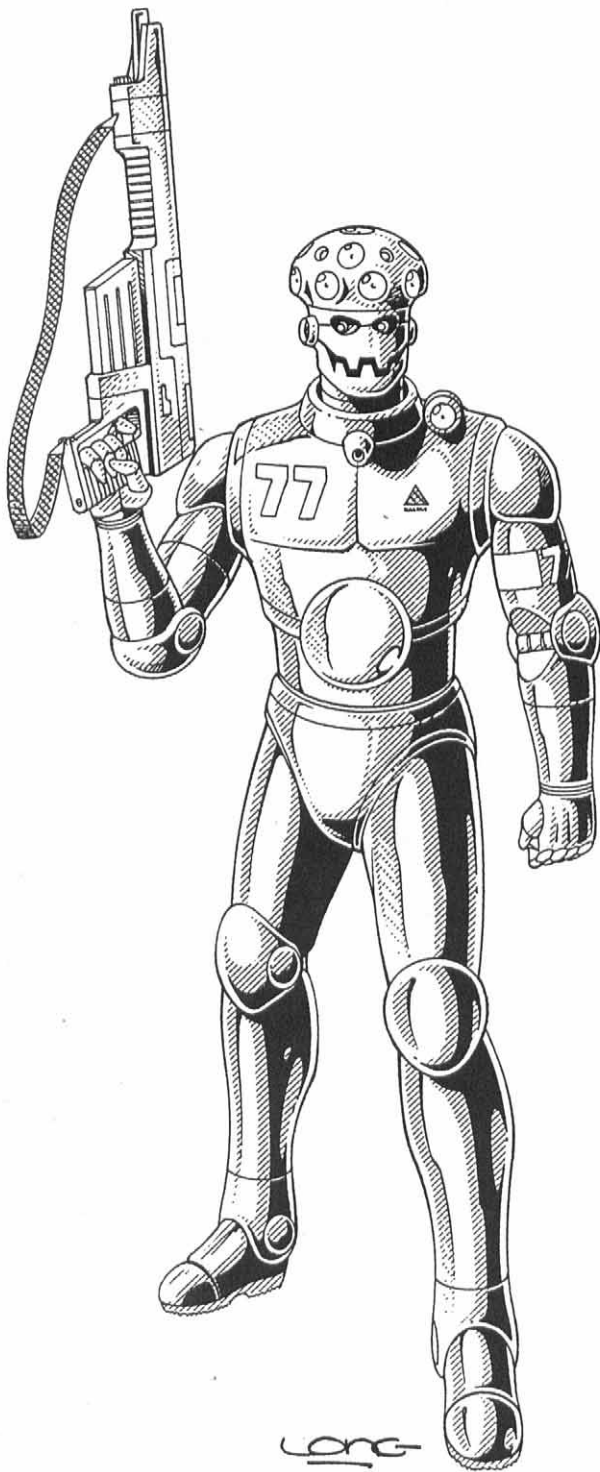

* Destroying the head of the robot will eliminate all optics and sensory systems. In most cases, the robot shuts down as a safety feature. However, in some cases, about one in ten, the robot continues to fight, blasting blindly until its ammunition is expended, and even then it will continue to grope around, lashing out and hitting anything it touches. Under these conditions, the robot enjoys no combat bonuses to strike, parry, or dodge! **Note:** The head is a small and difficult target to hit, especially on a moving target. Thus, it can only be hit when a character makes a *called shot* and even then the attacker is -2 to strike.

Depleting the M.D.C. of the main body will effectively destroy the bot, shutting it down completely and making it useless. **Note: Additional body armor or power armor cannot be worn by the robot.

Speed

Running: 100 mph (160 km) maximum. Note that the act of running does NOT tire the robot and speed can be maintained indefinitely.

Leaping: The robot legs, although strong, are not designed for leaping. Leaps are limited to approximately 12 feet (3.7 m) high or lengthwise. A running leap at speeds in excess of 60 mph (96 km) will enable the bot to leap an additional 2D6 + 6 yards/meters.

Flying: None, without the addition of a T-100 Eagle jet pack.

Range: The nuclear power pack gives the bot approximately five years of life even under the most strenuous conditions.

Statistical Data

Height: 8 feet (2.4 m)

Width: 3 feet (0.9 m)

Length: 3 feet (0.9 m)

Weight: 650 lbs (292.5 kg)

Physical Strength: Equal to a P.S. 40

Cargo: None

Power System: Nuclear, average energy life is five (5) years.

Black Market Cost: Although Triax Industries has been authorized to use DV-15 Dyna-bots for civilian, work and defense capacities, the Dyna-bots are not available to the mass market. Sentry bots have not been sold overseas in the Americas.

The black market will sell the bots for three million credits, new and undamaged.

Weapon Systems

The specific weapons used by the DV-15 can vary. The following is the standard DV-15 commonly used by the NGR military.

1. TX-30 Ion Pulse Rifle: The TX-30 is standard issue for the Sentry-bot. The ion rifle is used rather than the rail gun, because serving sentry duty, the bot does not need a long-range weapon that fires bursts. It needs a powerful short-range weapon to repel attackers in close combat. The TX-30 is the ideal choice: accurate and even more powerful than the light rail gun when it is fired in pulse mode, yet limited in range to 2000 feet (610 m). Of course, any handheld weapon can be used in its place.

Primary Purpose: Assault

Secondary Purpose: Defense

Weight: 7 pounds (3 kg)

Mega-Damage: 2D6 M.D. when a single shot is fired or 6D6 M.D. when turned on to pulse mode (3 simultaneous blasts at a single target).

Rate of Fire: Equal to the bot's hand to hand attacks (usually 6).

Maximum Effective Range: 2000 feet (610 m)

Payload: 40 shot short E-clip or a 50 shot long E-clip.

2. DV Laser finger guns (2): One of the fingers on each hand is a small laser that can be used as a tool or as a weapon.

Primary Purpose: Assault

Mega-Damage: Three settings: 1D6 × 10 S.D.C., or 1D6 M.D., or 2D6 M.D. per finger. The two fingers can be fired simultaneously at the same target (double damage) but only on an aimed shot.

Rate of Fire: Equal to the total number of hand to hand attacks.

Effective Range: 2000 feet (610 m)

Payload: Effectively unlimited.

Bonus: +1 to strike.

3. DV Concealed Particle Beam Rod (light): A particle beam weapon concealed in one of the legs and powered by the bot's nuclear battery.

Primary Purpose: Assault

Weight: 15 lbs (7 kg)

Mega-Damage: 5D6 + 6 M.D.

Range: 1600 feet (488 m)

Rate of Attack: Equal to the number of hand to hand melee attacks.

Payload: Effectively unlimited.

4. Chemical spray from the mouth: Inside the mouth is a spray unit that can release a variety of toxic mists (same as bionics, **Rifts RPG**, page 240). Sentry models are usually equipped with tranquilizer/sleep spray or tear gas. Total of 60 doses.

5. Hand to Hand Combat: Rather than use a weapon, the Sentry-bot can engage in mega-damage hand to hand combat using its fists or vibro-blades. *Six (6) attacks per melee!* Equal to Hand to Hand: Martial Arts.

Damage:

Restrained Punch — 2D6 + 25 S.D.C.

Full Strength Punch — 2D6 M.D.

Power punch — 4D6 + 4 M.D. (counts as two attacks)

Head butt — 1D6 M.D.

Kick — 1D8 M.D.

Jump Kick/Leap Attack — Double damage (2D8 M.D.)

Judo style throw/flip — 1D4 M.D.

Critical Strike on a natural roll of 19 or 20.

Combat Bonuses: Include all bonuses from combat programming, robot abilities and sensors. +6 on initiative, +2 to strike with a rail gun, +5 to strike with an automatic rifle, energy pistol, or energy rifle (see W.P. skills), +3 to strike with hand grenade or thrown object, +4 to strike on an aimed shot, +5 to strike with hand to hand attack (punch, kick, etc.), +7 to parry, +8 to dodge, +7 to parry and dodge attacks from behind (motion and sound detectors), +5 to roll with impact or fall, +8 to pull punch. Impervious to poison, gas, and biological agents, as well as psionic and magic mind control, charms, bio-manipulation, and S.D.C. attacks.

6. TX-50 Rail Gun (1): This is an optional accessory for the DV-15 Sentry-bot. See the DV-12 Dyna-bot description for complete details about this light, all-purpose weapon.

7. Optional TX-42 Laser Pulse Rifle, TX-500 Borg Rail Gun, or any type of assault rifle or light rail gun can be used in place of the standard issue weapons.

8. Hand Grenades: The Sentry-bot is sometimes provided with two to eight tear gas/stun grenades or smoke grenades to impair and confuse attackers or escaping prisoners. See the X-60 Flanker for a complete description of tear gas/stun and smoke grenades.

9. Combat Skill Program: W.P. sword, W.P. blunt, W.P. automatic rifle, W.P. energy pistol, W.P. energy rifle, W.P. heavy weapons/rail gun, and W.P. paired weapons. The paired weapons skill means the bot can use/fire two handheld tools, weapons or vibro-blades in one simultaneous attack, or attack with one and parry with the other. Hand to Hand: Martial Arts equal to 10th level skill (See number 5 for bonuses). The bots are programmed to recognize acts of aggression and to respond appropriately. It is interesting to note that deadly force is the response to most hostility.

Other skills from the combat program: Pilot hovercraft 96%, pilot jet pack 80%, pilot boat 80%, radio: basic 96%, intelligence 90%, land navigation 90%, track (humanoids) 80%, prowl 50% (includes penalties), gymnastics, and climb 96%/86% (can climb 5 × faster than the average humanoid). Languages include: Euro, American, Gobblely, and Techno-can, each at 96%; basic math 96%.

Programming and memory enables the bot to identify all known enemy forces of the New German Republic. Includes the identification of 5000 different enemy targets, including specific races, monsters, aliens, non-human features and powers, insignias, uniforms, enemy robots, vehicle designs, and notorious enemies of the Republic. Combat programming directs the actions and reactions to encounters and attacks.

10. Sensor Systems of Note

Optics: DV-15 Sentry-bots have full optical systems, including the visible light spectrum, infrared, ultraviolet, and polarization, passive night vision (light amplification), thermo-imaging, laser targeting, and telescopic. *Telescopic optics* function like built-in binoculars with a range of about two miles (3.2 km). All the other optic systems have a range of about 3000 feet (914 m).

Amplified Hearing: The Sentry-bot's sensor cap provides even greater range. It can hear sounds as quiet as 10 decibels as far away as 1000 feet (305 m). It can also hear in the ultrasonic range of high frequency sounds. The computer is programmed to recognize 50,000 different sounds, from crickets to the hum of an energy rifle. Adds to bonuses to strike, parry and dodge (see bonuses under combat).

Motion Detector: Increased range: 500 foot radius (153 m), adds to the ability to respond quickly, parry and dodge (see bonuses).

Radio Communication: Long-range, wide-band directional radio. Range: 500 miles (804 km). The bot communicates in the languages of Techno-can, Euro and American via voice synthesizers or direct radio transmission. The bot can identify several other languages, including traditional German, Gobblely, Dragonese, Faerie Speak and Gargoyle, but cannot understand or communicate in them. It can also eavesdrop on enemy transmissions and track them (60% success level) to their source. Range: 300 miles (482 km).

Speech: A synthesized voice system and loudspeaker are standard. The bot can simulate questions and dialogue about as well as any basic computer and give a verbal response. However, the voice is extremely mechanical and inhuman sounding. This is deliberate to prevent soldiers from getting attached/fond of these machines. **Note:** The Sentry-bot is programmed not to verbally respond to the enemy in any way and will fight till it or the enemy is destroyed. Robots are never given strategic or tactical information.

Infrared Searchlight: The light on the DV-15's shoulder/neck uses infrared light which is invisible to the human eye, but visible to the bot's infrared optics.

Molecular analyzer: Identical to the cybernetic lung implant.

Vibration Detectors are located in the feet and linked to the sensor cap on the head. Through these sensors, the bot can detect ground movement by troops and vehicles, and estimate their speed and direction.

DV-40 Hunter/Killer Drone

Like the Dyna-bot, the DV-40 Hunter/Killer drone was created to serve as an expendable substitute for human troops. The DV-40 is used to defoliate forests, destroy enemy strongholds and habitats, conduct Special Forces-like tactical assaults and to serve as front-line infantry troops and defenders. Millions of DV-12 Dyna-bots and DV-40 Hunter/Killers are part of the NGR Army. They may be sent into the wilderness on seek and destroy missions or fight side by side with human foot soldiers and armored troops. When dispatched on S&D missions, they are usually sent in groups of three and may be accompanied by 1D4 DV-12 Dyna-bots.

The orientation of the DV-40 is combat and destruction. Their programming is explicit: Find the enemy, eradicate the enemy and destroy their shelters, supplies, vehicles and equipment! And that is exactly what this robot does, with heartless efficiency!!

Triax Hunter/Killer Drone

Exclusive to the NGR Military

Model Type: DV-40

Class: Fully Automated Self-Sufficient Assault Robot

Crew: None; artificial intelligence

M.D.C. by Location:

TX-41 Laser Pulse Rifle (1, large) — 50

*Searchlight (1; visor in head) — 5

*Chainsaw (1; left hand) — 20

*Vibro-Sword (1; right arm) — 25

*Grenade Launcher (1; neck collar) — 15

*Flamethrowers (2) — 15 each

*Hands (2) — 40 each

Arms (2) — 100 each

Legs (2) — 120 each

*Head — 90

**Main Body — 300

* Areas marked with an asterisk are small or otherwise difficult targets to strike. An attacker must make a *called shot* to hit and even then is -3 to strike.

Destroying the head of the robot will eliminate all optics and sensory systems. In most cases, the robot shuts down as a safety feature. However, in some cases, about one in five, the robot continues to fight, blasting blindly until its ammunition is expended, and even then it will continue to grope around, lashing out and hitting anything it touches. Under these conditions, the robot enjoys no combat bonuses to strike, parry, or dodge! **Note:** The head is a small and difficult target to hit, especially on a moving target. Thus, it can only be hit when a character makes a *called shot* and even then the attacker is -2 to strike.

Depleting the M.D.C. of the main body will effectively destroy the bot, shutting it down completely and making it useless. **Note: Additional body armor or power armor cannot be worn by the robot.

Speed

Running: 70 mph (112 km) maximum. Note that the act of running does NOT tire the robot and speed can be maintained indefinitely.

Leaping: Approximately 25 feet (7.6 m) high or lengthwise. A running leap at speeds in excess of 50 mph (80 km) will enable the bot to leap an additional 2D6 + 6 yards/meters.

Flying: None, without the addition of a T-100 Eagle jet pack.

Range: The nuclear power pack gives the bot approximately five years of life even under the most strenuous conditions.

Statistical Data

Height: 13 feet (3.9 m)

Width: 7 feet (2.1 m)

Length: 4 feet, 5 inches (1.35 m)

Weight: One ton

Physical Strength: Equal to a P.S. 40

Cargo: None

Power System: Nuclear, average life is five (5) years.

Black Market Cost: The black market will sell the DV-40 for 10 million credits, new and undamaged. Poor availability.

Weapon Systems

1. TX-41 Laser Pulse Rifle (1): This is the giant-size version of the TX-42 infantry pulse rifle. The TX-41 is used by giant-sized robots and power armor that stand 10 to 20 feet tall (3 to 6 m).

The weapon is also a variable frequency laser with 12 different light frequencies. The operator can change frequencies with a touch or voice command. An internal computer makes the desired change. Number 7 counters the USA-10 Glitter Boy. The other settings are able to overcome other laser resistant armor.

Primary Purpose: Assault

Mega-Damage: 3D6 M.D. per single shot or 1D6 × 10 M.D. per rapid fire pulse of 3 shots (nearly simultaneous).

Rate of Fire: Equal to the total number of hand to hand attacks.

Effective Range: 4000 feet (1200 m)

Payload: 100. The giant, energy clip is located in the front of the gun. A special cable can connect the weapon to the bot's energy supply, giving it an effectively indefinite payload. The danger with the cable is that the weapon is rendered useless if the cable is cut. A second E-clip is concealed in a secret compartment in the left leg.

Note: A concealed storage compartment (1) is located in the left leg. It is typically used to hold an extra E-clip for the TX-41 pulse rifle, but can hold other odds and ends as well.

2. DV-40 Grenade Launcher (1): On the right side of the neck collar is a grenade launcher. This is a short-range, anti-personnel weapon that can fire explosive, plasma, smoke or riot control grenades.

Primary Purpose: Anti-Personnel

Secondary Purpose: Defensive Cover

Grenade Type & Mega-Damage: Varies; typically includes fragmentation (2D6 M.D. inflicted to a 20 foot/6 m radius), plasma (5D6 M.D. covering 12 foot/3.6 m diameter), smoke (no damage), or riot control/tear gas/stun (see the Flanker for grenade descriptions).

Maximum Range: 300 feet (91.5 m)

Rate of Fire: One at a time or in volleys of two or three fired in rapid succession.

Payload: 48 total. Typically 4 smoke, 4 tear gas, 20 plasma and 20 fragmentation.

3. DV-40 Concealed Particle Beam Rod (1): A particle beam weapon concealed in the right arm. It is powered by the bot's nuclear battery.



Primary Purpose: Assault

Weight: 15 lbs (7 kg)

Mega-Damage: 5D6 + 6 M.D.

Range: 1600 feet (488 m)

Rate of Attack: Equal to the number of hand to hand melee attacks.

Payload: Effectively unlimited.

4. DV-40 Laser finger guns (2): One of the fingers on each hand is a small laser that can be used as a tool or as a weapon.

Primary Purpose: Assault

Mega-Damage: Two settings: 2D6 M.D., or 3D6 M.D. per finger. The two fingers can be fired simultaneously at the same target (double damage) but only on an aimed shot.

Rate of Fire: Equal to the total number of hand to hand attacks.

Effective Range: 2000 feet (610 m)

Payload: Effectively unlimited.

5. Forearm Vibro-Sword (1): Located in the right forearm is a concealed, extendable and retractable vibro-sword. The weapon is three feet long (0.9 m).

Primary Purpose: Defense

Mega-Damage: 3D6 M.D.

Bonuses: +1 to strike and +1 to parry when engaged in hand to hand combat.

6. Diamond Tipped Chainsaw (1): Located on the left arm is a high-powered, diamond tipped chainsaw. This item is used primarily to cut down trees and slice-up debris. However, it can also make a formidable weapon.

Primary Purpose: Assault

Mega-Damage: 3D6 M.D. per melee attack or 3D6 × 6 M.D. per one full melee/15 seconds of cutting (no other attacks or actions during that time). This powerful tool can cut through mega-damage steel, concrete and rock like a hot knife through butter. The vibro-sword inflicts comparable damage but requires a stabbing or stab and sawing action to make choppy, uneven cuts. The chainsaw makes one long, even slice.

Rate of Fire: Equal to the total number of hand to hand attacks.

Effective Range: Touch

Payload: Effectively unlimited.

7. Flamethrowers (2): A pair of flamethrower turrets, capable of 360 degree rotation, are located on the rib cage area of the body.

Primary Purpose: Anti-Personnel

Secondary Purpose: Vegetation removal

Mega-Damage: 1D4 M.D. per single blast or 2D4 per simultaneous double blast of napalm-like fire. Plus there is a 01-90% likelihood of setting all combustible material, including fuel, wood, dry grass, clothes and hair, on fire. The fire does an additional 1D4 M.D. per melee round and burns for a minimum of 2D4 minutes.

Maximum Effective Range: 200 feet (61 m)

Rate of Fire: Equal to number of hand to hand attacks (usually 6).

Payload: A total of 50 blasts, 25 from each.

8. Optional TX-250 or TX-500 Rail Gun, or any type of giant-sized assault rifle or light rail gun can be used in place of the standard issue TX-41.

9. Optional TX-843P Interchangeable Particle Beam Cannon

(1): The DV-40 is equipped with TX-481 universal mounts just like the X-535 Jager. This weapon is an anti-armor infantry weapon that is mounted on the shoulders of the DV-40, just like the Jager, to give it extra firepower. It is used primar-

ily in troop assaults. The addition of the big gun reduces the robot's speed and combat bonuses by 25%. The cannon can be aimed up or down 80 degrees.

Primary Purpose: Anti-Armor

Secondary Purpose: Defense

Weight: Three tons, but comes with its own energy supply.

Mega-Damage: 2D4 × 10 M.D. per single blast!

Rate of Fire: Equal to number of hand to hand attacks (usually 6).

Maximum Effective Range: 3000 feet (914 m)

Payload: Effectively unlimited.

Special Feature: Independent power supply.

10. Optional TX-884I Interchangeable Ion Cannon & Missile

Launcher (1): The big cannon fires devastating ion blasts.

Six medium range missiles are housed in a launcher above each shoulder. Both launchers are capable of 180 degree upward rotation. This weapon reduces the robot's speed by 50%.

Primary Purpose: Anti-Armor

Secondary Purpose: Anti-Aircraft

Missile Type: Any medium range missile can be used, but standard military issue is armor piercing (2D4 × 10 M.D.; multi-warhead whenever possible) or plasma (2D6 × 10). Fragmentation may be used for anti-personnel operations.

Missile Rate of Fire: One at a time or in volleys of two or four.

Missile Payload: 12 missiles total; six in each launcher.

Missile Range: Usually about a 40+ miles (64+ km).

Mega-Damage of Ion Cannon: 1D6 × 10 per blast

Cannon Maximum Effective Range: 4000 feet (1200 m)

Cannon Rate of Fire: Equal to number of hand to hand attacks (usually 6).

Cannon Payload: Effectively unlimited.

Special Feature: The cannon has its own laser targeting and radar tracking system built into the weapon itself (the large round cylinder on top). This can be especially useful if the sensor head is destroyed or it can track targets independent of the DV-40's sensor head. Range: 6000 feet (1828 m). Bonus: +1 to strike.

Overall Weight: 6 tons

11. Hand to Hand Combat: Rather than use a weapon, the DV-40 can engage in mega-damage hand to hand combat using its fists or vibro-blades. *Six (6) attacks per melee!* Equal to Hand to Hand: Martial Arts.

Damage:

Restrained Punch — 1D6 M.D.C.

Full Strength Punch — 3D6 M.D.

Power Punch — 5D6 M.D. (counts as two attacks)

Chainsaw — 3D6 M.D.

Vibro-sword — 3D6

Head butt — 1D6 M.D.

Kick — 2D6 M.D.

Body Block — 2D6 M.D. (add 1D6 if running)

Jump Kick/Leap Attack — 4D6 M.D. (counts as two attacks)

Judo style throw/flip — 1D6 M.D.

Critical Strike on a natural roll of 19 or 20.

Combat Bonuses: Include all bonuses from combat programming, robot abilities and sensors. +5 on initiative, +2 to strike with a rail gun, +4 to strike with energy rifles, +3 to strike on an aimed shot, +6 to strike with hand to hand attack (punch, kick, etc.), +7 to parry, +5 to dodge, +5 to parry and dodge attacks from behind (motion and sound

detectors), +4 to roll with impact or fall, +4 to pull punch. Impervious to poison, gas, and biological agents, as well as psionic and magic mind control, charms, bio-manipulation, and S.D.C. attacks.

- 12. Combat Skill Program:** W.P. sword, W.P. blunt, W.P. automatic rifle, W.P. energy pistol, W.P. energy rifle, W.P. heavy weapons/rail gun, and W.P. paired weapons. The paired weapons skill means the bot can use/fire two handheld tools, weapons or vibro-blades in one simultaneous attack, or attack with one and parry with the other. Hand to Hand Martial Arts equal to 10th level skill (See number 11 for bonuses). The bots are programmed to recognize acts of aggression and to respond appropriately. It is interesting to note that deadly force is the response to most hostility.

Other skills from the combat program: Pilot hovercraft 96%, pilot boat 80%, radio: basic 96%, intelligence 90%, land navigation 90%, track (humanoids) 80%, prow1 30%, and climb 85%/75% (can climb 2× faster than the average humanoid). Languages include Euro, American, Gobblely, and Techno-can, each at 96%; basic math 96%.

Programming and memory enables the bot to identify all known enemy forces of the New German Republic. Includes the identification of 5000 different enemy targets, including specific races, monsters, aliens, non-human features and powers, insignias, uniforms, enemy robots, vehicle designs, and notorious enemies of the Republic. Combat programming directs the actions and reactions to encounters and attacks.

- 13. Sensor Systems of Note:** Identical to the DV-12.

Triax Enemy Infiltration Robots & Borgs

Robots Drones

Enemy Infiltration Robots or EIR — slang term “ears”

Note: Remember the general term “gargoyle” is an all encompassing racial description that includes the tiny gargoylite and the wingless gurgyle.

EIR-10 Gargoyle Drone
EIR-15 Gargoyle Manned
EIR-20 Gurgyle Drone
EIR-30 Gargoylite Drone
EIR-50 Gurgyle Android

Cyborgs

Enemy Infiltration Cyborgs or EIC — slang term “eeks”
EIC-100 Gurgyle

EIR Series Robots

Somebody among the military brass came up with the idea of developing unmanned, robot drones that could impersonate and infiltrate the enemy. It was virtually impossible for humans to disguise themselves as the eight to twelve foot (2.4 to 3.6 m) tall gurgyles, let alone the giant 10 to 20 foot (3 to 6 m) tall gargoyles, but a carefully designed robot with sculpted musculature, synthetic skin, and animated features could. When combined with the robot’s mechanical strength and seemingly supernatural endurance, the illusion would be complete.

Twenty years ago, Triax industries put into service the first Enemy Infiltration Robot (EIR or “ears”). Initially, the robot infiltration units were astonishingly effective against the Gargoyle Empire. The bots could penetrate enemy lines and mix among the real gargoyles and gurgyles without suspicion. Once among the enemy, the robots could transmit up to the minute information regarding enemy troop movements, strategies, and tactics. The EIRs were instrumental in identifying key gargoyle figures, commanders and allies as well as engaging in acts of sabotage, rescue and assassination.

Since the gargoyles and most supernatural beings relied entirely on magic, their superhuman powers and superior numbers, they never gave the idea of robot infiltrators a thought. At that point in time, the monsters had no use for human science. The

absence of technology and their lack of understanding of even low-tech equipment precluded even the simplest forms of detecting an EIR. The gargoyles couldn’t even conceive the idea of a robot, let alone a robot imposter. The infiltration robots could be standing in the middle of an army and transmit non-stop radio and/or audio-visual data without the gargoyles ever knowing it. Consequently, the NGR was able to deal the evil empire one devastating blow after another and push them far beyond their borders. Tens of thousands of gargoyles and their minions perished thanks to the information provided by the mechanical spies.

The Gargoyle Empire was on the verge of ruin. They began to turn their attention to other places with less powerful opponents. The Empire began to splinter from lack of confidence and frustration. Then, the first EIR was discovered. This was disastrous for two reasons. One, the gargoyles suddenly realized how the humans could be so prepared for their attacks and began to develop methods for ferreting out the robot spies. Two, it made the gargoyles realize the importance of at least understanding human technology. This was the worst thing that could have happened, because as they grew in understanding of technology, they also began to appreciate its value!

As a result, the gargoyles of Europe have made alliances with aliens and unscrupulous humans who have taught them to use simple radio wave signal scramblers to block radio signals and detection devices that can identify and track radio transmissions to their source. They have also learned ways to identify robot infiltrators and regularly use a variety of modern devices and energy weapons. Ironically, these gargoyles’ growing reliance on man’s technology has ostracized them from their demonic kin — never have demons, even gargoyle sub-demons, come to rely on technology like the Gargoyle Empire in Europe. That development intrigues Lord Splynncryth of Atlantis and concerns some demon lords. See the section on the **Gargoyle Empire for details.**

Undaunted, Triax and the NGR have found new ways to improve and disguise the Enemy Infiltration Robots.

Note: There is a 01-40% chance of the average gargoyle or one of their inhuman minions randomly detecting an EIR-10,

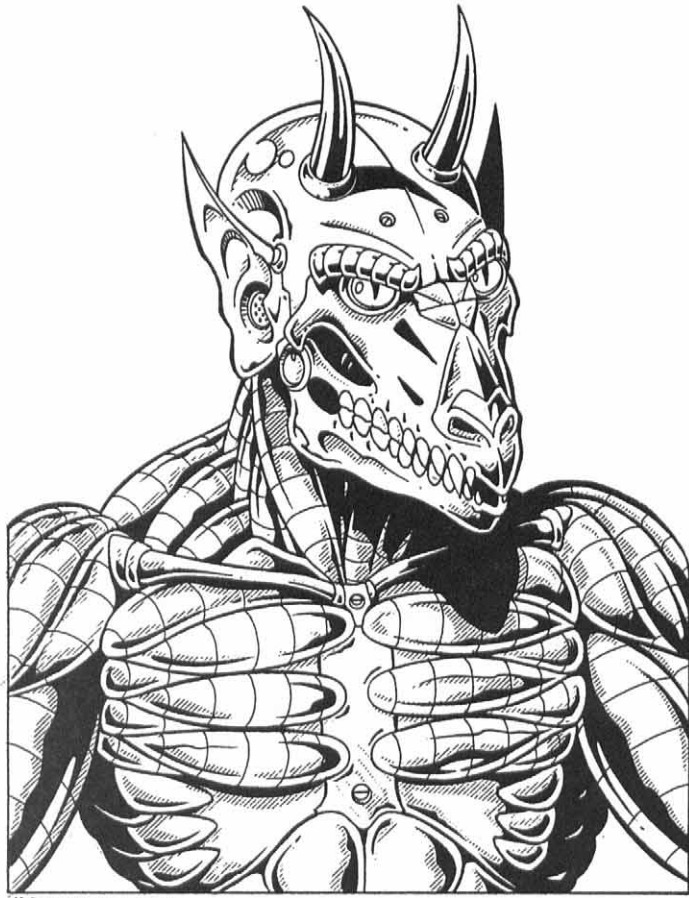

20 or 30 unit. The likelihood of discovery is increased to 01-60% if the enemy is actively trying locate EIRs or if the bot has infiltrated an elite group of warriors trained in the detection of EIRs. At locations where the gargoyles are working with technologically advanced allies, the likelihood of detection is dramatically higher (roll percentile dice): 01-55 for random detection and 01-80 as the result of a deliberate search. Detection of radio transmissions and tracing them to the source of transmission is 01-90. Reduce this number by 10 when trying to uncover an EIR-15 and by 40 when the subject of a search is an EIR-50 android or EIC cyborg.

Triax EIR-10 Gargoyle Drone

The EIR is a convincing imposter. The musculature and physiology is perfect. Mechanical joints and exhausts are carefully concealed. Tiny gears and bladders make facial expressions frighteningly realistic. The designers have even included vein-like hoses under the skin that contain fake blood to simulate bleeding from battle wounds. Bleeding wounds/hoses are sealed by tiny nano-bots that simulate the gargoyle's natural healing abilities. The skin covering is a tough, mega-damage resin the captures the look and feel of a real gargoyle.

If the gargoyle robot has a weakness, it is in regards to the wings and flight. Large thruster jets are too obvious so they can't be used. This means the wings must be capable of independent flight like the genuine article (boosted by concealed thrusters in the feet). Currently the gargoyle EIR is an excellent glider and capable of limited flight, but it is no where near as fast or maneuverable as the real beast. Consequently, it is best to keep

the bot in situations where it can stay on the ground and can get away with leaps and gliding. It is also wise to keep it away from other high flying gargoyles.

One gimmick sometimes used by the military is to have the wing(s) appear to be damaged, which might convince onlookers why the gargoyle is hesitant to fly, or when unavoidable, takes short, slow flights.

Enemy Infiltration Robots (EIRs) are used by the New German Republic mainly as spies and assassins on reconnaissance and seek and destroy missions. The programming for the EIR-10 is strictly combat and intelligence. They are also programmed to mimic the behavior and habits of gargoyles.

Note: The use of both the EIR-10 and EIR-15 is limited. The EIR-20 gargoyle is more able to pass unnoticed by the enemy because it is not expected to fly or stand out as a commanding officer. However, the gargoyle EIRs are often pivotal in penetrating enemy lines and misleading or even commanding enemy soldiers. One must remember that in the hierarchy of the gargoyles, the wingless gargoyles and tiny gargoylites are generally submissive to their larger winged brothers. Most gargoyles are effectively officers and elite troops, while gargoyles and other minions are the foot soldiers who obey and assist them.

Triax EIR-10 Gargoyle Drone

Exclusive to the NGR Military

Model Type: EIR-10

Class: Fully Automated Self-Sufficient Assault Robot

Crew: None; artificial intelligence

M.D.C. by Location:

Hands (2) — 25 each

Arms (2) — 60 each

Legs (2) — 130 each

Wings (2) — 110 each

Tail (1) — 100

Laser Fingers (2; one on each hand) — 8 each

Horns (2; head) — 10 each

*Head — 80

**Main Body — 250

* Destroying the head of the robot will eliminate all optics and sensory systems. In the case of Enemy Infiltration Robots, the bot continues to fight, blasting blindly until its ammunition is expended, and even then it will continue to grope around, lashing out and hitting anything it touches. Under these conditions, the robot enjoys no combat bonuses to strike, parry, or dodge! When the bot is finally destroyed or further incapacitated, an internal destruct mechanism explodes to prevent the device from falling into enemy hands. The internal workings of the bot are atomized and shrapnel flies everywhere, inflicting 1D6 × 10 M.D. to everything in a blast radius of 100 feet (30.5 m). Unlike other NGR bots, this explosion is not contained and is meant to damage the enemy.

Note: The head, hands and tail are small and/or difficult targets to hit. The attacker must make a *called shot* and even then the character is -2 to strike.

**Depleting the M.D.C. of the main body will effectively destroy the bot and activate the self-destruct mechanism.

Speed

Running: 40 mph (64 km) maximum, but faster than most real gargoyles whose running speed typically ranges between 15 to

35 mph (24 to 56 km). Note that the act of running does NOT tire the robot and speed can be maintained indefinitely.

Leaping: The robot legs are strong and designed for leaping. A normal leap is 20 feet (6 m) high or lengthwise. A running leap adds 1D6 + 6 additional yards/meters. Jet thruster assisted leaps (housed in the feet) are capable of reaching 80 feet (24.4 m) high or lengthwise.

Flying/Gliding: Limited. Maximum speed: 40 mph (64 km) and maximum height: 500 feet (153 m). Flight can be maintained for up to 15 minutes before the bot begins to lose altitude.

Range: The nuclear power pack gives the bot approximately five years of life even under the most strenuous conditions.

Statistical Data

Height: 15 feet (4.6 m)

Width: Body: 6 feet (1.8 m), wing span: 25 feet (7.6 m)

Length: Body: 4 feet (1.2 m). The tail is an additional 10 to 15 feet (3 to 4.6 m) long.

Weight: 2000 lbs (900 kg)

Physical Strength: Equal to a P.S. 40

Cargo: None

Power System: Nuclear, average life is five (5) years.

Black Market Cost: Not available; unknown to the black market.

Estimated value is 10 million credits.

Weapon Systems

1. Laser Eyes (2): Each of the robot's eyes can fire a powerful laser blast. 180 degree rotation/arc of fire — look and shoot.

Primary Purpose: Assault

Mega-Damage: 2D6 M.D. per single eye blast or 4D6 M.D. per double blast (both eyes fire simultaneously at the same target).

A double blast counts as one melee action.

Rate of Fire: Equal to the bot's total number of hand to hand attacks per melee.

Effective Range: 2000 feet (610 m)

Payload: Effectively unlimited.

Bonus: +1 to strike.

2. Laser Finger Guns (2): One of the fingers on each hand is a small laser that can be used as a tool or weapon.

Primary Purpose: Assault

Mega-Damage: Three settings: 1D6 × 10 S.D.C., or 1D6 M.D., or 2D6 M.D. per finger. The two fingers can be fired simultaneously at the same target (double damage) but only on an aimed shot.

Rate of Fire: Equal to the total number of hand to hand attacks.

Effective Range: 2000 feet (610 m)

Payload: Effectively unlimited.

Bonus: +1 to strike.

3. Concealed Vibro-blades in the Forearms (2): The blades are used only for assassination and when the bot is left with no other course of action to defend itself.

Primary Purpose: Assault

Mega-Damage: 4D6 M.D. each.

Range: Hand to hand.

Rate of Attack: Equal to the number of hand to hand melee attacks.

Payload: Not applicable.

4. Chemical spray from the mouth: Inside the mouth is a spray unit that can release a variety of toxic mists (same as bionics, **Rifts RPG**, page 240). Combat models are usually equipped with tranquilizer/sleep spray or tear gas. Total of 60 doses.

5. Hand to Hand Combat: Rather than use a weapon, the EIR can engage in mega-damage hand to hand combat using its fists, tail or vibro-blades. *Seven (7) attacks per melee!* Equal to Hand to Hand Martial Arts. Also note that the tail is prehensile and can be used to strike, or pick up and carry things.

Damage:

Restrained Punch — 3D6 + 25 S.D.C.

Full Strength Punch — 4D6 M.D.

Power Punch — 1D4 × 10 M.D.

Tail Strike — 2D6 M.D.

Bite — 2D4 M.D.

Head Butt — 1D6 M.D.

Kick — 4D6 M.D.

Jump Kick/Leap Attack — 1D4 × 10 M.D.

Judo style throw/flip — 1D6 M.D.

Critical Strike on a natural roll of 19 or 20.

Combat Bonuses: Include all bonuses from combat programming, robot abilities and sensors. +3 on initiative, +1 to strike with a rail gun, +3 to strike with an automatic rifle, energy pistol, or energy rifle (see W.P. skills), +4 to strike on an aimed shot, +6 to strike in hand to hand combat (punch, kick, etc.), +6 to parry with fists/arms/foot, +8 to parry with handheld weapon (knife, vibro-blade, etc.), +6 to dodge, +4 to parry and dodge attacks from behind (motion and sound detectors), +2 to roll with impact or fall, +4 to pull punch. Impervious to poison, gas, and biological agents, as well as psionic and magic mind control, charms, bio-manipulation, and S.D.C. attacks.

6. Optional handheld weapons, including giant-sized rail guns and energy cannons, magic weapons, swords, etc.

7. Combat Skill Program: W.P. sword, W.P. knife, W.P. energy pistol, W.P. energy rifle, W.P. heavy weapons/rail gun, and W.P. paired weapons. The paired weapons skill means the bot can manipulate handheld tools or weapons with both hands and in simultaneous coordinated attacks (double damage, counts as one attack/melee action, or attack with one and parry with the other). Hand to Hand: Martial Arts equal to 10th level skill (See number 5 for bonuses). The bots are programmed to recognize acts of aggression and to respond appropriately.

Other skills from the combat program: Pilot boat 80%, radio: basic 96%, basic electronics 90%, demolition and disposal 90%, anthropology: gargoyles 90% (customs & behavior), intelligence 90%, land navigation 90%, track (humanoids) 80%, prowl 50% (includes penalties), and climb 96%/86% (can climb 2 × faster than the average humanoid). Languages include: Euro, Techno-can, Gobblely, Gargoyle and Dragonese at 96%; basic math 96%.

Programming and memory enables the bot to identify all known enemy forces of the New German Republic. Includes the identification of 5000 different enemy targets, including specific races, monsters, aliens, non-human features and powers, insignias, uniforms, enemy robots, vehicle designs, and notorious enemies of the Republic. Combat programming directs the actions and reactions to encounters and attacks as a gargoyle would.

8. Sensor Systems of Note: Fundamentally the same as the Dyna-bot. Radio antennas, receivers and transmitters are built

into the ears, sound recording into the head, and concealed cameras are in the eyes under the lasers.

Optics: Full optical systems, including the visible light spectrum, infrared, ultraviolet, and polarization, passive nightvision (light amplification), thermo-imaging, laser targeting, and telescopic. *Telescopic optics* function like built-in binoculars with a range of about two miles (3.2 km). All the other optic systems have a range of about 3000 feet (914 m).

Amplified Hearing: Can hear sounds as quiet as 10 decibels as far away as 500 feet (152 m). Can also hear in the ultrasonic range of high frequency sound. The computer is programmed to recognize 50,000 different sounds, from bird chirps to the sound of a car engine or hum of an energy rifle. Adds to bonuses to strike, parry and dodge (see bonuses).

Motion Detector: 200 foot radius (61 m), adds to ability to parry and dodge (see bonuses).

Radio Communication: Long-range, wide-band directional radio. Range: 500 miles (804.5 km). The bot typically sends transmissions in the languages of Techno-can or Euro. The bot can identify several other languages, including traditional German and Faerie Speak, but can not understand or communicate in them. It can also eavesdrop on enemy transmissions and track transmissions (60% success level) to their source. Range: 50 miles (80 km).

Speech: Voice synthesizers give the robot a guttural, natural sounding voice. The bot can assimilate questions and respond with dialogue about as well and quickly as any basic computer. Verbal responses include gargoyle slang and expressions. The growls, snorts, stop and go, and gruff style of conversation used by the gargoyles suits the bots speech program well. **Note:** EIRs are never given strategic or tactical information regarding humans.

Triax EIR-15 Manned Gargoyle Bot

The living gargoyles range in size from 10 to 20 feet (3 to 6 m) with most averaging about 15 feet (4.6 m) tall. This makes the demons big enough to create an EIR that can be operated by a human pilot. The EIR-15 manned robot is virtually identical to the EIR-10 (unmanned) except that it is larger to accommodate a pilot. It is typically reserved for commandos and intelligence officers clad in T-11 enhanced body armor or super trooper power armor. There are only a couple thousand of these units available. **Note:** In addition to being used for infiltration, the EIR-15 is also used to explore other hostile territories designated as "Monster Zones." Gargoyle allies and other monsters are far less likely to antagonize, molest or question a pair of gargoyles (perhaps accompanied by EIR gargoyles) than they are humanoid adventurers.

The presence of a human pilot gives the bot a greater range of emotion, spontaneity and movement. Psionic probes will register a living presence, although the aura may look strangely non-gargoyle and a telepathic probe may pick-up on dangerously human thoughts. Psionic, electro-magnetic dampers have been installed to distort psychic probes just enough to fog the readings and to give the pilot some additional resistance to such probes (+1 to save vs psionic attack). All the better if the pilot is a psionic himself.

Triax EIR-15 Gargoyle Manned Robot

Exclusive to the NGR Military

Model Type: EIR-15

Class: Robot combat vehicle

Crew: One human pilot — typically commando or intelligence.

M.D.C. by Location:

Hands (2) — 30 each

Arms (2) — 80 each

Legs (2) — 150 each

Wings (2) — 110 each

Tail (1) — 100

Laser Fingers (2; one on each hand) — 10 each

Horns (2; head) — 10 each

*Head — 80

Pilot's Compartment — 50

**Main Body — 280

*Destroying the head of the robot will eliminate all optics and sensory systems, forcing the pilot to rely on his own senses. Reduce the bot's bonuses and attacks per melee round by half. The pilot can initiate an internal self-destruct mechanism to prevent the device from falling into enemy hands. The explosive can be detonated after the pilot exits the bot or while he is still inside. The explosion does 1D6 × 10 M.D. to everything in a blast radius of 100 feet (30.5 m) and 4D6 × 10 to the internal workings and pilot area. Unlike other NGR bots, this explosion is not contained and is meant to damage the enemy.

Note: The head, hands and tail are small and/or difficult targets to hit. The attacker must make a *called shot* and even then the character is -2 to strike.

**Depleting the M.D.C. of the main body will effectively destroy the bot and activate the self-destruct mechanism.

Speed

Running: 40 mph (64 km) maximum, but faster than most real gargoyles whose running speed typically ranges between 15 to 35 mph (24 to 56 km). Note that the act of running does NOT tire the robot or its pilot and speed can be maintained indefinitely.

Leaping: The robot legs are strong and designed for leaping. A normal leap is 20 feet (6 m) high or lengthwise. A running leap adds 1D6 + 6 additional yards/meters. Jet thruster assisted leaps (housed in the feet) are capable of reaching 80 foot (24.4 m) high or lengthwise.

Flying/Gliding: Limited. Maximum speed: 40 mph (64 km) and maximum height: 500 feet (153 m). Flight can be maintained for up to 15 minutes before the bot begins to lose altitude.

Range: The nuclear power pack gives the bot approximately five years of life even under the most strenuous conditions.

Statistical Data

Height: 20 feet (6 m)

Width: Body: 8 feet (2.4 m), wing span 30 feet (9 m)

Length: Body: 6 feet (1.8 m). The tail is an additional 10 to 15 feet (3 to 4.6 m) long.

Weight: 3000 lbs (1350 kg)

Physical Strength: Equal to a P.S. 40

Cargo: None

Power System: Nuclear, average life is five (5) years.

Black Market Cost: Not available; unknown to the black market. Estimated value is 10 million credits.

Weapon Systems

Note: Identical to the drone, only operated by the pilot. An internal computer and language translator enables the pilot to understand the words of monsters and reply in the appropriate language and voice.

Attacks Per Melee: The pilot's hand to hand plus one additional attack/action at levels one, three, five, eight and twelve of the pilot's experience.

Triax EIR-20 Gargoyle

The EIR-20 is the smaller, gargoyle version of the Enemy Infiltration Robot used by the NGR. It too is a convincing imposter with the musculature and physiology, concealed joints, and tiny gears and bladders to make facial expressions realistic. Like the EIR-10, this unit also has vein-like hoses under the skin that contain fake blood to simulate bleeding from battle wounds. The skin covering is a tough, mega-damage resin the captures the look and feel of a real gargoyle.

The EIR-20 gargoyle is used by the New German Republic mainly as spies and assassins, sent out to infiltrate enemy forces, and perform reconnaissance and seek and destroy missions. They may also be used against bandits and to ferret out gargoyle sympathizers. The programming for the EIR-20 is strictly combat and intelligence. They are also programmed to mimic the behavior and habits of gargoyle.

Triax EIR-20 Gargoyle Drone

Exclusive to the NGR Military

Model Type: EIR-20

Class: Fully Automated Self-Sufficient Assault Robot

Crew: None; artificial intelligence

M.D.C. by Location:

Hands (2) — 25 each

Arms (2) — 60 each

Legs (2) — 130 each

Tail (1) — 100

Laser Fingers (2; one on each hand) — 8 each

Horns (2; head) — 10 each

*Head — 80

**Main Body — 200

* Destroying the head of the robot will eliminate all optics and sensory systems. In the case of Enemy Infiltration Robots, the bot continues to fight, blasting blindly until its ammunition is expended, and even then it will continue to grope around, lashing out and hitting anything it touches. Under these conditions, the robot has no combat bonuses to strike, parry, or dodge! When the bot is finally destroyed or further incapacitated, an internal destruct mechanism explodes to prevent the device from falling into enemy hands. The internal workings of the bot are atomized and shrapnel flies, inflicting $1D6 \times 10$ M.D. to everything in a blast radius of 100 feet (30.5 m). Unlike other NGR bots, this explosion is not contained and is meant to damage the enemy.

Note: The head, hands and tail are small and/or difficult targets to hit. The attacker must make a *called shot* and even then the character is -2 to strike.

**Depleting the M.D.C. of the main body will effectively destroy the bot and activate the self-destruct mechanism.



K. SIEMBIEDA '94

Speed

Running: 50 mph (80 km) maximum, which is faster than most real gargoyle whose running speed typically ranges between 15 to 35 mph (24 to 56 km). Note that the act of running does NOT tire the robot and speed can be maintained indefinitely.

Leaping: The robot legs are strong and designed for leaping. A normal leap is 20 feet (6 m) high or lengthwise. A running leap adds $1D6 + 6$ additional yards/meters.

Flying: Not applicable.

Range: The nuclear power pack gives the bot approximately five years of life even under the most strenuous conditions.

Statistical Data

Height: 10 feet (3 m)

Width: 4 feet (1.2 m)

Length: 3 feet (0.9 m). The tail is an additional 8 feet (2.4 m) long.

Weight: 1000 lbs (450 kg)

Physical Strength: Equal to a P.S. 30

Cargo: None

Power System: Nuclear, average life is five (5) years.

Black Market Cost: Not available; unknown to the black market. Estimated value is 8 million credits.

Weapon Systems

1. Laser Eyes (2): Each of the robot's eyes can fire a powerful laser blast. 180 degree rotation/arc of fire — look and shoot.

Primary Purpose: Assault

Mega-Damage: $2D6$ M.D. per single eye blast or $4D6$ M.D. per double blast (both eyes fire simultaneously at the same target).

A double blast counts as one melee action.

Rate of Fire: Equal to the bot's total number of hand to hand attacks per melee.

Effective Range: 2000 feet (610 m)

Payload: Effectively unlimited.

Bonus: +1 to strike.

2. Laser Finger Guns (2): One of the fingers on each hand is a small laser that can be used as a tool or weapon.

Primary Purpose: Assault

Mega-Damage: Three settings: 1D6 × 10 S.D.C., or 1D6 M.D., or 2D6 M.D. per finger. The two fingers can be fired simultaneously at the same target (double damage) but only on an aimed shot.

Rate of Fire: Equal to the total number of hand to hand attacks.

Effective Range: 2000 feet (610 m)

Payload: Effectively unlimited.

Bonus: +1 to strike.

3. DV-40 Concealed Particle Beam Rod (1): A particle beam weapon is concealed in the right leg. It is powered by the bot's nuclear battery.

Primary Purpose: Assault

Weight: 15 lbs (7 kg)

Mega-Damage: 5D6 + 6 M.D.

Range: 1600 feet (488 m)

Rate of Attack: Equal to the number of hand to hand melee attacks.

Payload: Effectively unlimited.

4. Chemical spray from the mouth: Inside the mouth is a spray unit that can release a variety of toxic mists (same as bionics, **Rifts RPG**, page 240). Combat models are usually equipped with tranquilizer/sleep spray or tear gas. Total of 60 doses.

5. Hand to Hand Combat: Rather than use a weapon, the EIR can engage in mega-damage hand to hand combat using its fists, tail or vibro-blades. *Seven (7) attacks per melee!* Equal to Hand to Hand: Martial Arts. Also note that the tail is prehensile and can be used to strike, or pick up and carry things.

Damage:

Restrained Punch — 3D6 + 15 S.D.C.

Full Strength Punch — 3D6 M.D.

Power Punch — 1D4 × 10 M.D.

Tail Strike — 2D6 M.D.

Bite — 2D4 M.D.

Head Butt — 1D6 M.D.

Kick — 4D6 M.D.

Jump Kick/Leap Attack — 1D4 × 10 M.D.

Judo style throw/flip — 1D6 M.D.

Critical Strike on a natural roll of 19 or 20.

Combat Bonuses: Include all bonuses from combat programming, robot abilities and sensors. +3 on initiative, +1 to strike with a rail gun, +3 to strike with an automatic rifle, energy pistol, or energy rifle (see W.P. skills of the EIR-10), +4 to strike on an aimed shot, +6 to strike in hand to hand combat (punch, kick, etc.), +6 to parry with fists/arms/foot, +8 to parry with handheld weapon (knife, vibro-blade, etc.), +6 to dodge, +4 to parry and dodge attacks from behind (motion and sound detectors), +2 to roll with impact or fall, +4 to pull punch. Impervious to poison, gas, and biological agents, as well as psionic and magic mind control, charms, bio-manipulation, and S.D.C. attacks.

6. Optional handheld weapons, including rail guns, energy cannons, grenades, magic weapons, swords, etc.

7. Combat Skill Program: Same as the EIR-10.

8. Sensor Systems of Note: Same as the EIR-10.

EIR-30 Gargoylite

Reconnaissance and Surveillance Unit

The gargoylite EIR-30 is a small and inexpensive spy unit. It is designed with full audio/visual transmission and recording capabilities. The little robot can either transmit everything it sees and hears and/or record data for retrieval and viewing at a later date. The robot's small size and stealth capabilities enables it to prowl among gargoyles and gurgoyles without being too conspicuous. The EIR-30 is especially effective during conflicts when the enemy's attention is focused on other things. If suspected of being an EIR, the bot can zoom away by using concealed thrusters located beneath its wings and tail.

Like its living counterpart, the EIR-30 is also an excellent thief, sneaking into rooms or areas and stealing or sabotaging items of importance to the enemy. They can also be used to sneak out human prisoners, information, tools, weapons and food.

Unlike the larger EIR, the tiny spy bot has no fake blood or highly articulated facial expressions. It is simply a robot made to resemble the diminutive gargoylite long enough to slip into strategic places, gather data, place explosives, rescue prisoners, and get out.

Triax EIR-30 Gargoylite Drone

Exclusive to the NGR Military

Model Type: EIR-30

Class: Fully Automated Self-Sufficient Assault Robot

Crew: None; artificial intelligence

M.D.C. by Location:

Hands (2) — 5 each

Arms (2) — 15 each

Legs (2) — 30 each

Wings (2) — 10 each

Tail (1) — 10

Laser Fingers (2; one on each hand) — 2 each

*Head — 30

**Main Body — 50

*Destroying the head of the robot will initiate the self-destruct mechanism. The internal workings of the bot are atomized and shrapnel flies everywhere, inflicting 4D6 M.D. to everything in a blast radius of 50 feet (15.2 m). Unlike other NGR bots, this explosion is not contained and is meant to damage the enemy.

Note: The head, hands and tail are small and difficult targets to hit. The attacker must make a *called shot* and even then the character is -3 to strike.

**Depleting the M.D.C. of the main body will effectively destroy the bot and also activate the self-destruct mechanism.

Speed

Running: 10 mph (16 km) maximum

Leaping: Five feet (1.5 m) high or lengthwise. A running leap adds 1D6 additional feet. Jet thruster assisted leaps (housed in the back, tail and feet) are capable of reaching 80 feet (24.4 m) high or lengthwise.

Flying: The concealed thrusters give the tiny spy bot a maximum speed of 120 mph (192 km). Maximum height is 5000 feet (1530 m). Flight can be maintained indefinitely.

Range: The nuclear power pack gives the bot approximately five years of life even under the most strenuous conditions.

Statistical Data

Height: 3 feet (0.9 m)

Width: 1 foot, 5 inches (0.35 m)

Length: 1 foot, 5 inches (0.35 m). The stubby tail adds another one foot (0.3 m).

Weight: 100 lbs (45 kg)

Physical Strength: Equal to a P.S. 20

Cargo: None

Power System: Nuclear, average life is five (5) years.

Black Market Cost: Not available; unknown to the black market. Estimated value is 10 million credits.

Weapon Systems

1. Laser Finger Guns (2): One of the fingers on each hand is a small laser that can be used as a tool or weapon.

Primary Purpose: Assault

Mega-Damage: Three settings: 1D6 × 10 S.D.C., or 1D6 M.D., or 2D6 M.D. per finger. The two fingers can be fired simultaneously at the same target (double damage) but only on an aimed shot.

Rate of Fire: Equal to the total number of hand to hand attacks.

Effective Range: 2000 feet (610 m)

Payload: Effectively unlimited.

Bonus: +1 to strike.

2. Chemical spray from the mouth: Inside the mouth is a spray unit that can release a variety of toxic mists (same as bionics, **Rifts RPG**, page 240). Combat models are usually equipped with tranquilizer/sleep spray or tear gas. Total of 15 doses.

3. Hand to Hand Combat: Rather than use a weapon, the EIR can engage in mega-damage hand to hand combat using its fists or handheld weapons. Its small size makes it a poor combatant without a weapon of some kind, ideally a human-size energy handgun. *Five (5) attacks per melee!* Equal to Hand to Hand Expert. Also note that the tail is prehensile and can be used to pick-up and carry things.

Damage:

Restrained Punch — 1D6 + 5 S.D.C.

Full Strength Punch — 1D4 M.D.

Power Punch — 2D4 M.D.

Tail Strike — Not applicable; too small

Bite — One M.D.

Head Butt — 4D6 + 5 S.D.C.

Kick — 1D4 M.D.

Jump Kick/Leap Attack — 1D6 M.D.

Combat Bonuses: Include all bonuses from combat programming, robot abilities and sensors. +3 on initiative, +3 to strike with an automatic pistol, revolver or energy pistol (see W.P. skills), +2 to strike on an aimed shot, +2 to strike in hand to hand combat (punch, kick, etc.), +1 to parry with fists/arms/foot, +3 to parry with handheld weapon (knife, vibro-blade, etc.), +6 to dodge, +1 to parry and dodge attacks from behind (motion and sound detectors), +4 to roll with impact or fall, +4 to pull punch. Impervious to poison, gas, and biological agents, as well as psionic and magic mind control, charms, bio-manipulation, and S.D.C. attacks.

4. Optional handheld weapons including handguns, vibro-blades and explosives.

5. Combat Skill Program: W.P. knife, W.P. revolver, W.P. automatic pistol, W.P. energy pistol, and W.P. paired weapons. The paired weapons skill means the bot can use tools or weapons with both hands and in simultaneous coordinated attacks (double damage, counts as one attack/melee action, or attack with one and parry with the other). Hand to Hand: Expert is equal to a 10th level skill (See number 3 for all bonuses). The bots are programmed to recognize acts of aggression and to respond appropriately.

Other skills from the combat program: Pilot hover vehicles, horsemanship 80%, pilot boat 80%, radio: basic 96%, basic electronics 90%, demolition and disposal 90%, anthropology: gargoyles 90% (customs & behavior), intelligence 90%, land navigation 90%, track (humanoids) 80%, prowl 60% (includes penalties), and climb 96%/86% (can climb 3 × faster than the average humanoid). Languages include: Euro, Techno-can, Gobblely, Gargoyle and Dragonese at 96%; basic math 96%.

Programming and memory enables the bot to identify all known enemy forces of the New German Republic. Includes the identification of 5000 different enemy targets, including specific races, monsters, aliens, non-human features and powers, insignias, uniforms, enemy robots, vehicle designs, and notorious enemies of the Republic. Combat programming directs the actions and reactions to encounters and attacks as a gargoylite would.

6. Sensor Systems of Note: The same as the Dyna-bot. Radio antennas, receivers and transmitters are built into the ears, sound recording into the head. Cameras and recording faculties are located in the eyes and mouth.

EIR-50 Gurgyle Android

The EIR-50 is an experiment in the field of robotics and cybernetics. The geniuses at Triax have perfected a way to replace the living brain of a recently deceased gurgyle with a robot brain! Scores of cybernetic implants are placed inside the flesh and blood body giving the artificial brain control over it, the same way it controls and manipulates a mechanical body. It is the creature's superhuman, mega-damage body and remarkable recuperative powers that enables it to survive the complex operation and heal without serious damage to the body.

This incredible, living machine has the body of a real gurgyle that will pass virtually all gurgyle tests, but is controlled by the artificial brain. Additional cybernetic implants can provide concealed weapons, sensors and radio transmission features. Although a success on the most basic level, the android responds somewhat slower than bots or living gargoyles and the cybernetic systems needed to keep the body alive and functioning are tremendously expensive.

Only the highest officials at Triax Industries' robot and cybernetics divisions and the NGR military intelligence divisions know anything about this top secret project. The ghoulish idea of creating what is effectively a zombie, would not sit well with most civilians and NGR political leaders. The EIR-50 android has been designed with the intention of replacing the gurgyle cyborgs (EIC-100) which jeopardize human lives.

The EIR-50 android is used in exactly the same way as the other Enemy Infiltration Robots sent out to infiltrate enemy forces, perform reconnaissance and destroy the enemy. Unless an autopsy is performed, the gargoyles will never know they had an organic robot in their midst. Instead, they will think one of their troops has fallen victim to mind control or has been bought off by the enemy.

Triax EIR-50 Gargoyle Android

Exclusive to the NGR Military

Model Type: EIR-50

Class: Fully Automated, Organic Assault Robot

Crew: None; artificial intelligence

M.D.C. by Location: Same as the average living gargoyle.

Typically:

Hands (2) — 20 each

Arms (2) — 2D4 × 10 each

Legs (2) — 2D6 × 10 each

Tail (1) — 2D6 × 10

Cyber-Laser Fingers (2; one on each hand) — 8 each

Horns (2; head) — 10 each

*Head — 2D4 × 10

**Main Body — 1D4 × 100

*Destroying the head of the android will eliminate all optics and the artificial brain that controls and directs the body, effectively killing it. The head, hands and tail are small and/or difficult targets to hit. The attacker must make a *called shot* and even then the character is -2 to strike.

**Depleting the M.D.C. of the main body will effectively destroy/kill the android.

Note: The robot brain is designed to self destruct when the android perishes or when it is surgically removed. This damage is minimal and does not inflict explosive damage to an area.

Speed & Physical Attributes

Effectively the same as a living gargoyle.

Average Speed Running: 22.5 mph (36 km); a speed attribute of 33.

Statistical Data

Effectively the same as a living gargoyle.

Average Height: Typically 10 feet (3 m) tall, but can range from 8 to 12 feet (2.4 to 3.6 m).

Average Weight: 1300 lbs (585 kg)

Average Physical Strength: P.S. 30

Power System: Nuclear, average life is five (5) years.

Black Market Cost: Not available; unknown to the black market. Estimated value unknown.

Weapon Systems

1. Laser Finger Guns (2): One of the fingers on each hand is artificial and contains a small laser that can be used as a tool or weapon.

Primary Purpose: Assault

Mega-Damage: Three settings: 1D6 × 10 S.D.C., or 1D6 M.D., or 2D6 M.D. per finger. The two fingers can be fired simultaneously at the same target (double damage) but only on an aimed shot.

Rate of Fire: Equal to the total number of hand to hand attacks.

Effective Range: 2000 feet (610 m)

Payload: Effectively unlimited.

Bonus: +1 to strike.

2. Garrote Wrist Wire (1): A thin, strong wire hidden inside a cybernetic housing (in this case the wire is giant-sized and quite thick). The wire can be extended to strangle an opponent, usually from behind. It is then retracted to hide the evidence of the murder weapon.

Primary Purpose: Assassination

Mega-Damage: Equal to a power punch: 6D6 M.D. per melee action (every time it is pulled tighter).

3. Hand to Hand Combat: Rather than use a weapon, the EIR can engage in mega-damage hand to hand combat using its fists, tail or feet. *Seven (7) attacks per melee!* Equal to Hand to Hand: Martial Arts. Also note that the tail is prehensile and can be used to strike, or pick up and carry things.

Damage:

Restrained Punch — 3D6 + 15 S.D.C.

Full Strength Punch — 3D6 M.D.

Power Punch — 6D6 M.D.

Tail Strike — 2D6 M.D.

Bite — 1D6 M.D.

Head Butt — 1D4 M.D. (not advisable)

Kick — 3D6 M.D.

Jump Kick/Leap Attack — 6D6 M.D.

Judo style throw/flip — 1D6 M.D.

Critical Strike on a natural roll of 19 or 20.

Combat Bonuses: Include all bonuses from combat programming, robot abilities and sensors. +1 on initiative, +1 to strike with a rail gun, +2 to strike with an automatic rifle, energy pistol, or energy rifle (see W.P. skills of the EIR-10), +1 to strike on an aimed shot, +4 to strike in hand to hand combat (punch, kick, etc.), +4 to parry with fists/arms/foot, +6 to parry with handheld weapon (knife, vibro-blade, etc.), +4 to dodge, +2 to parry and dodge attacks from behind (motion and sound detectors), +2 to roll with impact or fall, +2 to pull punch. Impervious to poison, gas, and biological agents, as well as psionic and magic mind control, charms, bio-manipulation, and S.D.C. attacks.

4. Optional Handheld Weapons, including rail guns, energy cannons, grenades, magic weapons, swords, etc., can be used by the android.

5. Optional Additional Bionics: One arm, or leg, or the tail can be an artificial bionic limb (probably cosmetically disguised) and given one or two additional concealed weapons or features.

6. Combat Skill Program: Same as the EIR-10.

7. Sensor Systems of Note: Same as the EIR-10. Cameras and optics are concealed in artificial eyes. Transmission and radio features in the ears and head.

Triax EIC-100 Cyborg

So far, the NGR's best infiltration operative is a full conversion borg disguised as a gargoyle. This is done by creating a bionic body housing shaped like a gargoyle. The body is then cosmetically enhanced and covered with gargoyle-like artificial skin.

As part man and part machine, the borg reacts to situations with human ingenuity and emotion. The character uses human judgement, can make subjective decisions, alter plans and be-

havior to best suit the situation, as well as lie, cheat and pretend — all traits that even the best robot program cannot emulate. Too often the robots are awkward or slow to respond, especially during intimate contact. The cyborg by contrast, has an inventive human mind to give the disguise the proper personality, exhibiting mercy, anger, joy, attitude and other characteristics to help convince the enemy that he is one of them.

Since a cyborg is a living being, psionic probes will register a living presence, although the aura may look strangely non-gurgoyle-like. A telepathic probe will indicate the presence of a living mind, although the probe may reveal some suspiciously human thoughts. Psionic electro-magnetic dampers have been installed in the borg to distort psychic probes just enough to fog the readings and to give the character some additional resistance to such psychic investigations (+1 to save vs psionic attack).

The EIC-100 cyborgs are intelligence operatives who, like the robot drones, infiltrate the enemy for the purposes of reconnaissance, intelligence and assassination. Unlike the bots, they can also engage in tactics that confuse, distract and divide the enemy. This can include deception, sabotage, vandalism, robbery, blackmail and tricks of all kinds.

Triax EIC-100 Gurgoyle Cyborg

Exclusive to the NGR Military

Note: The following stats are for the “standard” EIC-100 borg. Specific weapons and bionic features may change slightly from borg to borg.

Model Type: EIC-100

Class: Cyborg

Crew: One human volunteer — typically with a background in intelligence.

M.D.C. by Location:

Hands (2) — 20 each

Arms (2) — 60 each

Legs (2) — 90 each

Tail (1) — 100

Horns (2; head) — 10 each

*Head — 100 (the gurgoyle head is large and reinforced)

**Main Body — 250 plus 135 from gurgoyle body armor

*Destroying the head of the cyborg will kill the character! However, the head is a small and difficult target to hit. The attacker must make a *called shot* and even then the character is -3 to strike.

**Depleting the M.D.C. of the main body will effectively destroy the artificial body, but emergency systems will keep the brain and vital organs alive for 36 hours. Recovery of the severely damaged body will enable doctors to place the character on a life support system that will keep him alive until a new bionic body (EIC or other) is available for full conversion. Failure to find the damaged borg within 36 hours means the character dies. Similarly, massive amounts of damage (125 points below zero) completely destroys the borg with no hope for recovery.

Speed

Running: 90 mph (144 km) maximum; roughly two and a half times faster than most real gurgoyles. Note cyborgs fatigue at one-third the rate of a normal human.

Leaping: The over-sized bionic legs are strong and capable of leaping 20 feet (6 m) high or lengthwise. A running leap adds 1D6+6 additional yards/meters.

Flying: Via jet pack only.

Statistical Data

Average Height: 9 feet (2.7 m)

Width: 3 feet, 6 inches (1 m)

Length: 3 feet (0.9 m). The tail is an additional 8 feet (2.4 m) long.

Weight: 1200 lbs (540 kg)

Physical Attributes: Equal to a P.S. 30, P.P. 24, Spd. 132

Power System: Nuclear, average life is 20 years.

Black Market Cost: Not available; unknown to the black market.

Estimated value is two million credits.

Standard Bionic Features (non-weapon types)

Note: These features are all found in the bionic and cybernetic sections of the **Rifts RPG**.

1. Bionic lung with gas filter & oxygen storage cell
2. Built-in language translator
3. Built-in radio receiver & transmitter
4. Camera finger
5. Climb cord (concealed)
6. Clock calendar
7. Concealed energy-clip hand or arm port (1)
8. Fingerjack
9. Gyro-compass
10. Modulating voice synthesizer
11. Multi-optic eyes
12. Prehensile Tail: Add one melee action/attack; P.S. 24.
13. Universal headjack & amplified hearing

Weapon Systems

1. Laser or Particle Beam Eyes (2): Each of the robot's eyes can fire a powerful energy blast. 180 degree rotation/arc of fire — look and shoot.

The advantage of the P-beam eyes is that it inflicts massive amounts of damage. On the negative side, it has a comparatively short range.

Laser:

Primary Purpose: Assault

Mega-Damage: 2D6 M.D. per single eye blast or 4D6 M.D. per double blast (both eyes fire simultaneously at the same target).

A double blast counts as one melee action.

Rate of Fire: Equal to the borg's total number of hand to hand attacks per melee.

Effective Range: 2000 feet (610 m)

Payload: Effectively unlimited.

Bonus: +1 to strike.

Particle Beam:

Primary Purpose: Assault

Mega-Damage: 5D6+6 M.D. per single eye blast or 1D6×10+12 M.D. per double blast (both eyes fire simultaneously at the same target). A double blast counts as one melee action.

Rate of Fire: Equal to the character's total number of hand to hand attacks per melee.

Effective Range: 800 feet (245 m)

Payload: Effectively unlimited.

Bonus: +1 to strike.

Note: Exclusive to the NGR military — an over-sized head like that of the gurgoyle is needed.

2. Laser Finger Guns (2): One of the fingers on each hand is a small laser that can be used as a tool or weapon.

Primary Purpose: Assault

Mega-Damage: Three settings: 1D6 × 10 S.D.C., or 1D6 M.D., or 2D6 M.D. per finger. The two fingers can be fired simultaneously at the same target (double damage) but only on an aimed shot.

Rate of Fire: Equal to the total number of hand to hand attacks.

Effective Range: 2000 feet (610 m)

Payload: Effectively unlimited.

Bonus: +1 to strike.

3. VX-40 Concealed Particle Beam Rod (1): A particle beam weapon is concealed in the right leg. It is powered by the borg's nuclear battery.

Primary Purpose: Assault

Weight: 15 lbs (7 kg)

Mega-Damage: 5D6 + 6 M.D.

Range: 1600 feet (488 m)

Rate of Attack: Equal to the number of hand to hand melee attacks.

Payload: Effectively unlimited.

4. Chemical spray from the mouth: Inside the mouth is a spray unit that can release a variety of toxic mists (same as bionics, **Rifts RPG**, page 240). Combat models are usually equipped with tranquilizer/sleep spray or tear gas. Total of 15 doses.

5. Retractable Vibro-Blade: A large vibro-sword is concealed in the right or left arm.

Primary Purpose: Defense

Mega-damage: 2D6 M.D.

6. Hand to Hand Combat: Rather than use a weapon, the EIC-100 can engage in mega-damage hand to hand combat using its fists, tail or vibro-blades. Also note that the tail is prehensile and can be used to strike, or pick up and carry things.

Attacks per Melee Round: Equal to the character's hand to hand combat skill selection and experience, plus one additional attack/action from heightened reflexes and one from the prehensile tail.

Combat Bonuses: +1 on initiative, +1 to pull punch, +1 to roll with impact, and +2 to save vs horror factor

Damage:

Restrained Punch — 1D6 + 15 S.D.C.

Full Strength Punch — 1D4 M.D.

Power Punch — 2D6 M.D.

Tail Strike — 1D6 M.D.

Bite — 6D6 S.D.C.

Head Butt — 1D4 M.D.

Kick — 1D4 M.D.

Jump Kick/Leap Attack — 2D4 M.D.

Judo style throw/flip — 6D6 S.D.C.

7. Optional handheld weapons including rail guns, energy rifles, grenades, magic weapons, etc. can be used.



VX-Series Cyborgs

The usual rules concerning the creation of cyborgs, as found in the **Rifts RPG**, still apply to the European/NGR borg character. However, the military has eight standard combat cyborgs created for the army (and this includes ex-military cyborg soldiers turned mercenaries). They are described in this section.

VX-Series Cyborgs

VX-300 Striker (human-size)

VX-320 Cyclops (human-size)

VX-340 Slasher/Gold Type

VX-370 Stopper/Blue Type

VX-500 Manhunter/Red Type

VX-635 Prowler (human-size)

VX-2010 Maurader

VX-2020 Monster

Note: Also see the EIC-100 Gargoyle Borg

VX-300 Striker

The Striker is a light assault borg designed for reconnaissance, guerrilla warfare and seek and destroy missions. It is fast, incredibly mobile and roughly human size. The menacing armored head is actually a reinforced helmet that is integrated into the cybernetic system to create a full environmental armor. The helmet can be removed to reveal the character's human face. Likewise, the gauntlet can be removed to show the human hand and the missile plate to lighten the armor even more.

Triax VX-300 Cyborg Soldier

Exclusive to the NGR Military

Note: The following stats are for the "standard" VX-300 full conversion borg. Specific weapons and bionic features may change slightly from borg to borg.

Model Type: VX-300

Class: Full Conversion Cyborg

Crew: One human volunteer.

M.D.C. by Location:

Hand (1) — 10

Right Arm (1) — 40

Gun Arm (1) — 60

Ammo-Drum (1, back) — 60

Shoulders & Launchers (2) — 50 each

Legs (2) — 75 each

Head — 60 (reinforced)

Main Body — 180 plus an additional 100 M.D.C. from light espionage body armor plates that hook directly to the bionic body.

*Destroying the head of a cyborg will kill the character! However, the head is a small and difficult target to hit. The attacker must make a *called shot* and even then he is -3 to strike.

**Depleting the M.D.C. of the main body will effectively destroy the artificial body, but emergency systems will keep the brain and vital organs alive for 36 hours. Recovery of the severely damaged body will enable doctors to place the charac-

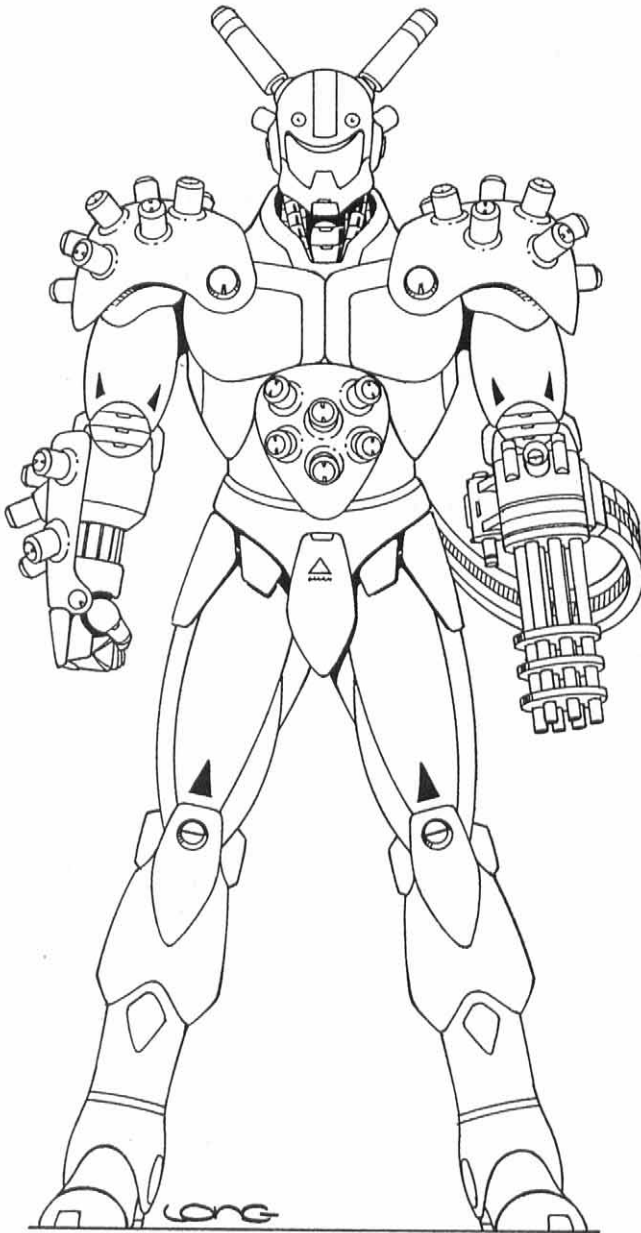

ter on a life support system that will keep him alive until a new bionic body (same style or other) is available for full conversion. Failure to find the damaged borg within 36 hours means the character dies. Similarly, massive amounts of damage (125 points below zero) completely destroys the borg with no hope for recovery.

Speed

Running: 120 mph (192 km) maximum

Leaping: The powerful bionic legs are strong and capable of leaping 20 feet (6 m) high or lengthwise. A running leap adds 30 additional feet (9 meters).

Flying: Via jet pack only.

Statistical Data

Average Height: 7 feet, 6 inches (2.2 m)

Width: 3 feet, 6 inches (1 m)

Length: 2 feet, 6 inches (0.7 m).

Weight: 600 lbs (270 kg)

Physical Attributes: Equal to a P.S. 24, P.P. 21, Spd. 170

Power System: Nuclear, average life is 20 years.

Black Market Cost: Two to four million credits with all standard features and weapons. Poor availability.

Standard Bionic Features (non-weapon types)

Note: These features are all found in the bionic and cybernetic sections of the **Rifts RPG**.

1. Bionic lung with gas filter & oxygen storage cell
2. Built-in language translator
3. Built-in radio receiver & transmitter
4. Climb cord (concealed)
5. Clock/calendar
6. Concealed energy-clip hand or arm port (1)
7. Gyro-compass
8. Modulating voice synthesizer
9. Multi-optic eyes
10. Psionic electro-magnetic dampers
11. Universal headjack with amplified hearing and sound filtration

Weapon Systems

1. **VX-300 Multiple Grenade Launcher System:** A unique method of launching grenades is built into the armor of this borg. Each of the canister-like protrusions represent one grenade. Each grenade has its own launch system inside its housing. The grenades used for the VX-Series of armaments are slightly different than hand grenades.

Primary Purpose: Anti-Personnel

Secondary Purpose: Defense

Grenade Type & Mega-Damage: Special VX-300 fragmentation grenades that inflict 3D6 M.D. to everything within the blast radius of 50 feet (15 m). Or plasma: 5D6 M.D. to a 12 foot (3.6 m) radius, or tear gas/stun or smoke.

Range: 300 feet (91.5 m).

Rate of Fire: One at a time or volleys of two, three or four.

Payload: 25 total; seven in each shoulder, five on the forearm and six in the belly. A typical grenade combination is 3 stun/tear gas, 8 plasma, and 14 fragmentation.

2. **VX-300 Rail Gun-Arm (1, standard issue):** This is a light, all-purpose weapon that is built directly into the borg as part of his left forearm. The VX-300 rail gun can use a short clip with 200 rounds (10 bursts) or a heavy belt-feed drum containing 2000 rounds (100 bursts). The weapon arm can be replaced by a mechanical human-like arm or other weapon arm as needed or desired.

Primary Purpose: Assault

Secondary Purpose: Defense

Weight: Gun-arm: 60 lbs (27 kg), short clip: 10 pounds (4.5 kg), or a heavy ammo-drum: 100 lbs (45 kg). The ammo-drum is hooked to the back of the body housing.

Mega-Damage: A full damage burst fires 20 rounds and inflicts 4D6 M.D.; a single round does two M.D. The weapon may also fire DU-rounds inflicting 5D6 M.D., or U-rounds also doing 5D6 M.D. (plus diminishes healing in supernatural beings).

Rate of Fire: Equal to the character's hand to hand attacks per melee round (usually 4 to 6).

Maximum Effective Range: 4000 feet (1200 m)

Payload: The short clip holds 200 rounds and is capable of firing ten full damage bursts (20 rounds).

The 2000 round drum is capable of firing 100 full damage bursts (20 rounds each).

Reloading a drum will take about three minutes for those not trained, but a mere 30 seconds by a capable field mechanic. A strength of 24 or higher is required to handle the drum.

Special VX-300 Feature: 1) The VX-300 rail gun-arm has its own laser targeting/distancing, telescopic sight and nightvision scope. Telescopic and laser targeting range is 6000 feet (1828 m). Bonus: +1 to strike.

3. Laser Finger Gun (1): One of the fingers on the hand is a small laser that can be used as a tool or weapon.

Primary Purpose: Assault

Mega-Damage: Three settings: 1D6 × 10 S.D.C., or 1D6 M.D., or 2D6 M.D.

Rate of Fire: Equal to the total number of hand to hand attacks.

Effective Range: 500 feet (152 m)

Payload: Effectively unlimited.

Bonus: +1 to strike.

4. Hand to Hand Combat: Rather than use a weapon, the cyborg can engage in mega-damage hand to hand combat. Remember, although sheathed in M.D. body armor and weapons, the cyborg's physical strength is S.D.C. based except for the occasional special attack, such as power punch.

Attacks per Melee Round: Equal to the character's hand to hand combat skill selection and experience, plus one additional attack/action from heightened reflexes.

Combat Bonuses: +2 on initiative, +2 to pull punch, +2 to roll with impact, and +1 to save vs horror factor. P.P. 21 bonus: +3 to strike, parry and dodge.

Damage:

Restrained Punch — 1D6+9 S.D.C.

Full Strength Punch — 3D6+9 S.D.C.

Power Punch — 1D4 M.D. (counts as 2 melee attacks)

Head Butt — 2D6 S.D.C.

Kick — 3D6+9 S.D.C.

Jump Kick/Leap Attack — 1D6 M.D. (counts as 2 melee attacks)

Judo style throw/flip — 2D6 S.D.C.

5. Optional handheld weapons, including rail guns, energy rifles, grenades, magic weapons, etc. can be used. Other bionic weapons, such as concealed weapon rods, tools and compartments, may also be integrated into this borg.

6. Typical Training/Skills: See the *Cyborg Soldier O.C.C.* for complete details. In the case of the VX-300, at least three of the five (5) "other" O.C.C. related skills must be selected from the espionage category (not normally available to borgs). Each gets a bonus of +10%.

VX-320 Cyclops

The VX-320 cyclops is another light, human-size, human looking cyborg. Its appearance is that of a normal human in heavy body armor. It gets its name from the single slot visor built into the head. The gauntlets and forearm plates can be removed to reveal human (looking) hands and arms.

Triax VX-320 Cyborg Soldier

Part of the NGR Military

Note: The following stats are for the "standard" VX-320 full conversion borg. Specific weapons and bionic features may change slightly from borg to borg.

Model Type: VX-320

Class: Full Conversion Cyborg — light assault

Crew: One human volunteer.

M.D.C. by Location:

Hands (2) — 10 each

Arms (2) — 40 each

Forearm Guns (2) — 10 each

Grenade Launcher (1) — 30

Legs (2) — 70 each

Head — 50 (reinforced)

Main Body — 180 plus an additional 100 M.D.C. from light body armor plates that hook directly to the bionic body.

*Destroying the head of a cyborg will kill the character! However, the head is a small and difficult target to hit. The attacker must make a *called shot* and even then he is -3 to strike. The hands, forearm guns and grenade launcher are also difficult targets to hit and are -4 to strike on a called shot.

**Depleting the M.D.C. of the main body will effectively destroy the artificial body, but emergency systems will keep the brain and vital organs alive for 36 hours. Recovery of the severely damaged body will enable doctors to place the character on a life support system that will keep him alive until a new bionic body (same style or other) is available for full conversion. Failure to find the damaged borg within 36 hours

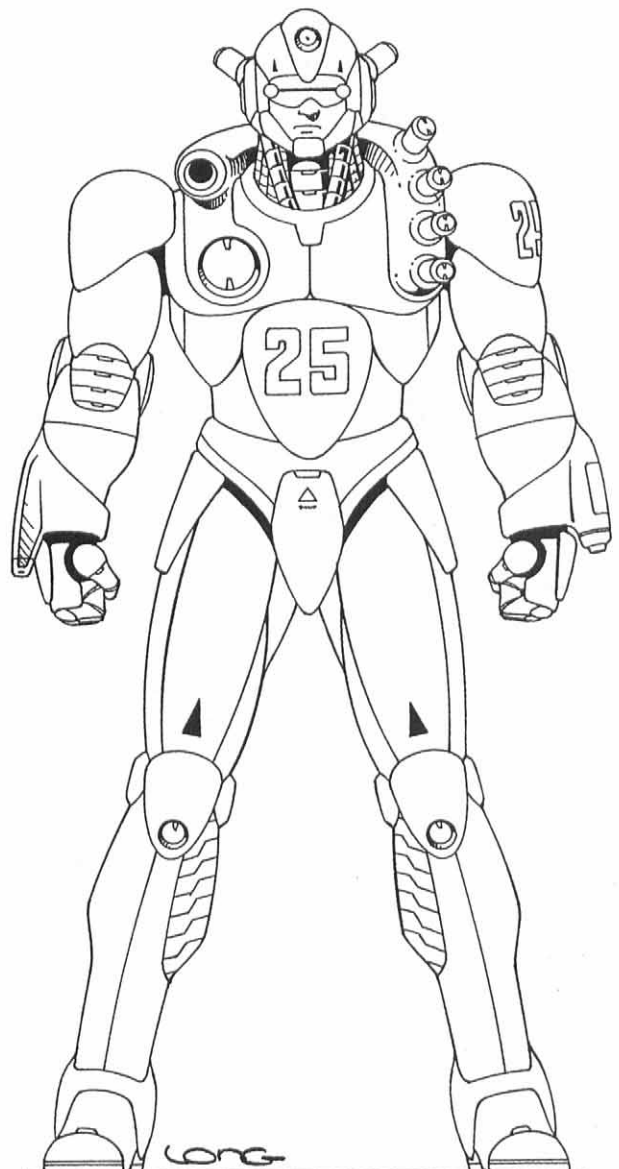

means the character dies. Similarly, massive amounts of damage (125 points below zero) completely destroys the borg with no hope for recovery.

Speed

Running: 100 mph (160 km) maximum

Leaping: The powerful bionic legs are strong and capable of leaping 15 feet (4.6 m) high or lengthwise. A running leap adds 30 additional feet (9 meters).

Flying: Via jet pack only; see the T-100 Eagle jet pack.

Statistical Data

Average Height: 6 feet, 6 inches (2 m)

Width: 3 feet, 6 inches (1 m)

Length: 2 feet, 6 inches (0.7 m).

Weight: 500 lbs (225 kg)

Physical Attributes: Equal to a P.S. 24, P.P. 21, Spd. 154

Power System: Nuclear, average life is 20 years.

Black Market Cost: Two to four million credits with all standard features and weapons. Fair availability.

Standard Bionic Features (non-weapon types)

Note: These features are all found in the bionic and cybernetic sections of the **Rifts RPG**.

1. Bionic lung with gas filter & oxygen storage cell
2. Built-in language translator
3. Built-in radio receiver & transmitter
4. Climb cord (concealed)
5. Clock calendar
6. Concealed energy-clip hand or arm port (1 in each arm)
7. Gyro-compass
8. Modulating voice synthesizer
9. Multi-optic eyes
10. Psionic electro-magnetic dampers
11. Universal headjack with amplified hearing and sound filtration

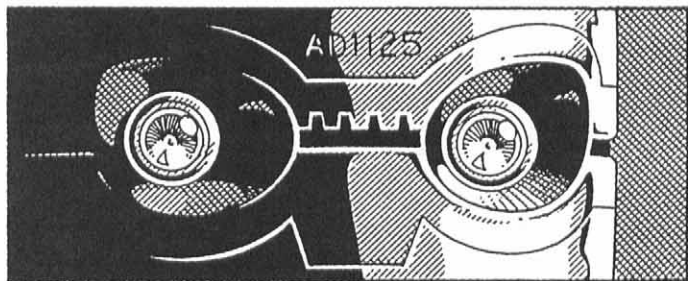

Weapon Systems

1. VX-320 Multiple Grenade Launcher System: A grenade launching system built into the armor of the borg. Each of the canister-like protrusions represent one grenade. Each grenade has its own launch system inside its housing. The grenades used for the VX-Series of armaments are slightly different than hand grenades.

Primary Purpose: Anti-Personnel

Secondary Purpose: Defense

Grenade Type & Mega-Damage: Special fragmentation grenades that inflict 3D6 M.D. to everything within the blast radius of 50 feet (30.5 m). Or plasma: 5D6 M.D. to a 12 foot (3.6 m) radius, or tear gas/stun or smoke.

Range: 300 feet (91.5 m).

Rate of Fire: One at a time or volleys of two, three or four.

Payload: 25 total; seven in each shoulder, five on the forearm and six in the belly. A typical grenade combination is 10 plasma, 3 smoke and 12 fragmentation.

2. VX-320 Wide Beam Ion Disrupter (1): The large opening near the right shoulder is a newly developed weapon from Triax, an ion beam disrupter. The weapon fires an energy pulse or sphere that expands in size to strike two or more targets standing in close proximity to each other. The weapon is extremely short ranged.

Primary Purpose: Anti-personnel

Mega-Damage: Typically 2D6 M.D. per blast to everything within a 10 foot (3 m) diameter. 4D6 M.D. at point-blank range (within four feet/1.2 m).

Rate of Fire: A maximum of twice per melee round. Each blast counts as one melee action/attack.

Effective Range: 60 feet (18.3 m)

Payload: Effectively unlimited; patched into the borg's power supply.

3. Laser Forearm Gun (1): The right arm has a laser forearm blaster. Point and shoot.

Primary Purpose: Assault

Mega-Damage: 2D6 M.D. per blast.

Rate of Fire: Equal to the total number of hand to hand attacks.

Effective Range: 2000 feet (609 m)

Payload: 20 shots per E-clip.

Note: Unlike the bulkier versions, this light design has neither a penalty or bonus to strike when using the forearm weapon.

4. Ion Forearm Gun (1): The left arm has an ion forearm blaster. Point and shoot.

Primary Purpose: Assault

Mega-Damage: 3D6 M.D. per blast.

Rate of Fire: Equal to the total number of hand to hand attacks.

Effective Range: 1000 feet (305 m)

Payload: 20 shots per E-clip.

Note: Unlike the bulkier versions, this light design has neither a penalty or bonus to strike when using the forearm weapon.

5. Hand to Hand Combat: Rather than use a weapon, the cyborg can engage in mega-damage hand to hand combat. Remember, although sheathed in M.D. body armor and weapons, the cyborg's physical strength is S.D.C. based except for the occasional special attack, such as power punch.

Attacks per Melee Round: Equal to the character's hand to hand combat skill selection and experience, plus one additional attack/action from heightened reflexes.

Combat Bonuses: +2 on initiative, +2 to pull punch, +2 to roll with impact, and +1 to save vs horror factor. P.P. 21 bonus: +3 to strike, parry and dodge.

Damage:

Restrained Punch — 1D6+9 S.D.C.

Full Strength Punch — 3D6+9 S.D.C.

Power Punch — 1D4 M.D.

Head Butt — 2D6 S.D.C.

Kick — 3D6+9 S.D.C.

Jump Kick/Leap Attack — 1D6 M.D.

Judo style throw/flip — 2D6 S.D.C.

6. Optional handheld weapons, including rail guns, energy rifles, grenades, magic weapons, etc. can be used. Other bionic weapons, such as concealed weapon rods, tools and compartments may also be integrated into this borg.

7. Typical Training/Skills: See the *Cyborg Soldier O.C.C.* for complete details. As for the VX-320, there are no special skill options.

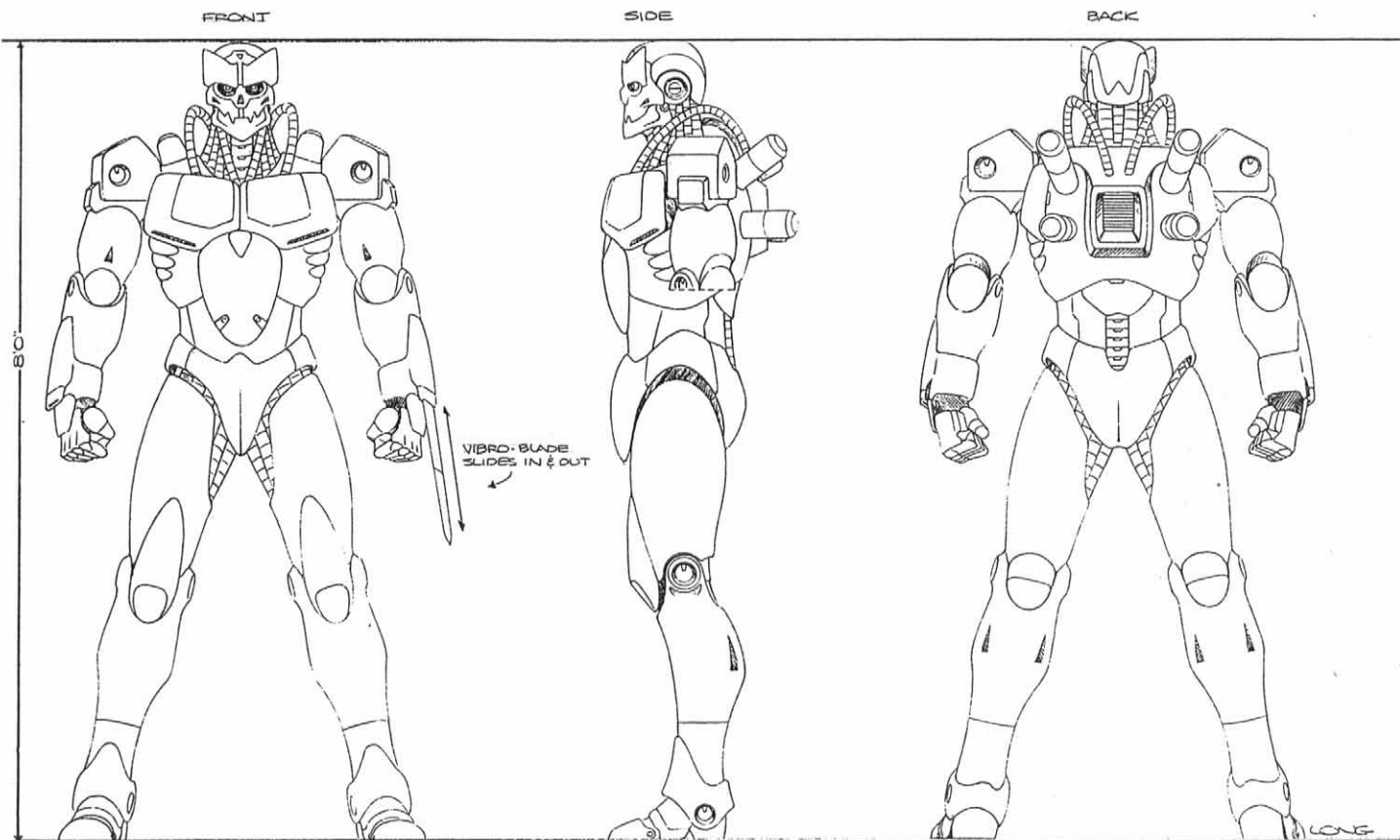

VX-340 Slasher (Gold Type)

The VX-340 Slasher is a full conversion cyborg also known as the “Gold Type” borg because of the metallic gold color used in mass market editions. The Slasher has a monstrous looking head to strike fear into his opponents. This borg rarely incorporates heavy forearm weapons so that it has maximum mobility, strike and parry bonuses, and free hands to set explosives and operate assault weapons. The Slasher is often sent on espionage or seek and destroy missions. At least half of these characters have wilderness and tracking skills.

Triax VX-340 Cyborg Soldier

Part of the NGR Military

Note: The following stats are for the “standard” VX-340 full conversion borg. Specific weapons and bionic features may change slightly from borg to borg.

Model Type: VX-340 Gold

Class: Full Conversion Cyborg — Light Assault

Crew: One human volunteer.

M.D.C. by Location:

Hands (2) — 15 each

Arms (2) — 40 each

Vibro-Blades (2) — 10 each

Mini-Missile Launch Tubes (4, back) — 20 each

TX-500 Rail Gun (1) — 75

Rail Gun Drum (1) — 75

Legs (2) — 80 each

*Head — 90 (reinforced)

**Main Body (normal) — 180 plus an additional 270 M.D.C. from its light infantry armor (hooks directly to the bionic body).

* Destroying the head of a cyborg will kill the character! However, the head is a small and difficult target to hit. The attacker must make a *called shot* and even then he is -3 to strike. The hands, missile tubes, and grenade launcher are also difficult targets to hit and are -4 to strike on a called shot.

**Depleting the M.D.C. of the main body will effectively destroy the artificial body, but emergency systems will keep the brain and vital organs alive for 36 hours. Recovery of the severely damaged body will enable doctors to place the character on a life support system that will keep him alive until a new bionic body (same style or other) is available for full conversion. Failure to find the damaged borg within 36 hours means the character dies. Similarly, massive amounts of damage (125 points below zero) completely destroys the borg with no hope for recovery.

Speed

Running: 100 mph (160 km) in the standard light infantry armor or 120 mph (192 km) in light espionage armor or no additional armor.

Leaping: The powerful bionic legs are strong and capable of leaping 25 feet (7.6 m) high or lengthwise. A running leap adds 30 additional feet (9 m).

Flying: Via jet pack only; see the T-100 Eagle jet pack (half speed only because of the weight of the borg).

Statistical Data

Average Height: 8 feet (2.4 m)

Width: 4 feet (1.2 m)

Length: 3 feet (0.9 m) is the length of the body itself. Four feet (1.2 m) including the small launch tubes.

Weight: 1000 lbs (450 kg)

Physical Attributes: Equal to a P.S. 27, P.P. 24, Spd. 154 with light infantry armor.

Power System: Nuclear, average life is 20 years.

Market Cost: Five million credits with all standard features and weapons. Poor availability.

Penalties: The so-called light infantry armor provides excellent mega-damage protection but is actually quiet heavy so there are some movement penalties; -1 to parry and dodge, -1 to roll with impact, and -20% on prowl.

Standard Bionic Features (non-weapon types)

Note: These features are all found in the bionic and cybernetic sections of the **Rifts RPG**.

1. Bionic lung with gas filter & oxygen storage cell
2. Built-in language translator
3. Built-in loudspeaker
4. Built-in radio receiver & transmitter
5. Climb cord (concealed)
6. Clock/calendar
7. Concealed energy-clip hand or arm port (1 in each arm)
8. Gyro-compass
9. Modulating voice synthesizer
10. Multi-optic eyes
11. Psionic electro-magnetic dampers
12. Universal headjack with amplified hearing and sound filtration

Weapon Systems

1. Concealed Vibro-Blades (2): Each forearm has a vibro-sword that can be extended and retracted at will.

Primary Purpose: Anti-Personnel

Mega-Damage: 2D6 M.D. per strike.

Attacks Per Melee Round: Total hand to hand melee actions.

Note: The borg's P.P. of 24 provides a strike and parry bonus of +5, not including any W.P. Sword bonuses.

2. VX-340 Mini-Missile Tube Launchers (4): Four single-shot mini-missile tube launchers are mounted on the back of the borg.

Primary Purpose: Anti-Aircraft

Secondary Purpose: Defense

Missile Type: Any mini-missile can be used, but standard issue is armor piercing (1D4 × 10 M.D.) or plasma (1D6 × 10). Fragmentation is seldom used by these anti-armor units.

Mega-Damage: Varies with missile type.

Range: Usually about a mile.

Rate of Fire: One at a time or volleys of two or three.

Payload: Four total; one in each tube.

3. Concealed Leg Laser Rod (1): The right or left hip contains a laser rod. Release, point and shoot.

Primary Purpose: Assault

Mega-Damage: 3D6 M.D. per blast.

Rate of Fire: Equal to the total number of hand to hand attacks.

Effective Range: 3000 feet (914 m)

Payload: 20 shots per E-clip.

4. TX-500 or TX-250 Triax Borg Rail Gun (1; standard issue, pick one): The TX-500 is a comparatively, lightweight, portable weapon designed for use by borgs and other creatures with a strength of 24 (or higher).

Weight: Gun: 80 lbs (36.3 kg), Power Pack: 50 lbs (22.7 kg), One light ammo-drum belt: 25 lbs (11 kg), a case of six light belts: 150 lbs (67.5 kg).

Mega-Damage: A full burst is 30 rounds and inflicts 6D6 M.D. A half burst is 15 rounds and inflicts 3D6 M.D. One round does

1D4 M.D. Depleted uranium rounds adds an additional 2D6 M.D. to a full burst or 1D6 M.D. to a half burst.

Rate of Fire: One burst per hand to hand melee action/attack.

Maximum Effective Range: 4000 feet (1200 m)

Payload: Heavy ammo-drum 1170 rounds (39 full 6D6 bursts), light drum/Ammo-belt 390 rounds (13 full 6D6 bursts). Or it can be fitted with the mini-clip which contains 90 rounds (3 full bursts). Each mini-clip weighs 10 lbs (4.5 kg).

Market Cost: 85,000 credits. Fair availability.

Note: The TX-500 comes equipped with a telescopic, nightvision scope and laser targeting system. Bonus: +1 to strike.

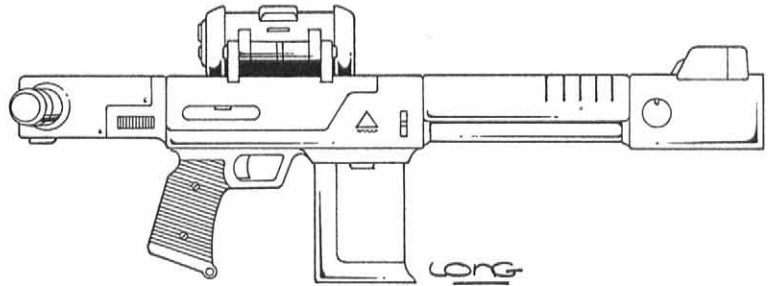

5. Concealed Weapon Compartments: The standard VX-340 has two concealed compartments in the chest that typically holds a pair of vibro-knives (1D6 M.D.) and two to eight hand grenades (any type).

6. Hand to Hand Combat: Rather than use a weapon, the cyborg can engage in mega-damage hand to hand combat. Remember, although sheathed in M.D. body armor and weapons, the cyborg's physical strength is S.D.C. based except for the occasional special attack, such as power punch.

Attacks per Melee Round: Equal to the character's hand to hand combat skill selection and experience, plus one additional attack/action from heightened reflexes.

Combat Bonuses: +2 on initiative, +3 to pull punch, +1 to roll with impact, and +1 to save vs horror factor. P.P. 24 bonus: +5 to strike, parry and dodge.

Damage:

Restrained Punch — 1D6 + 12 S.D.C.

Full Strength Punch — 3D6 + 12 S.D.C.

Power Punch — 1D4 M.D. (counts as 2 melee attacks)

Head Butt — 2D6 S.D.C.

Kick — 4D6 + 12 S.D.C.

Jump Kick/Leap Attack — 2D4 M.D. (counts as 2 melee attacks)

Judo Style Throw/Flip — 3D6 S.D.C.

Full Speed Ram/Body Block — 1D4 M.D. (counts as 2 melee attacks)

7. Optional handheld weapons, including other rail guns, energy rifles, grenades, magic weapons, etc., can be used. Other bionic weapons, such as concealed weapon rods, tools and compartments, may also be integrated into this borg.

8. Typical Training/Skills: See the *Cyborg Soldier O.C.C.* for complete details. In the case of the VX-340, at least three of the five (5) "other" O.C.C. related skills must be selected from the wilderness category (not normally available to borgs). Each skill gets a bonus of +10%. Plus the typical VX-340 gets the espionage skill of tracking (humanoids, +5%).

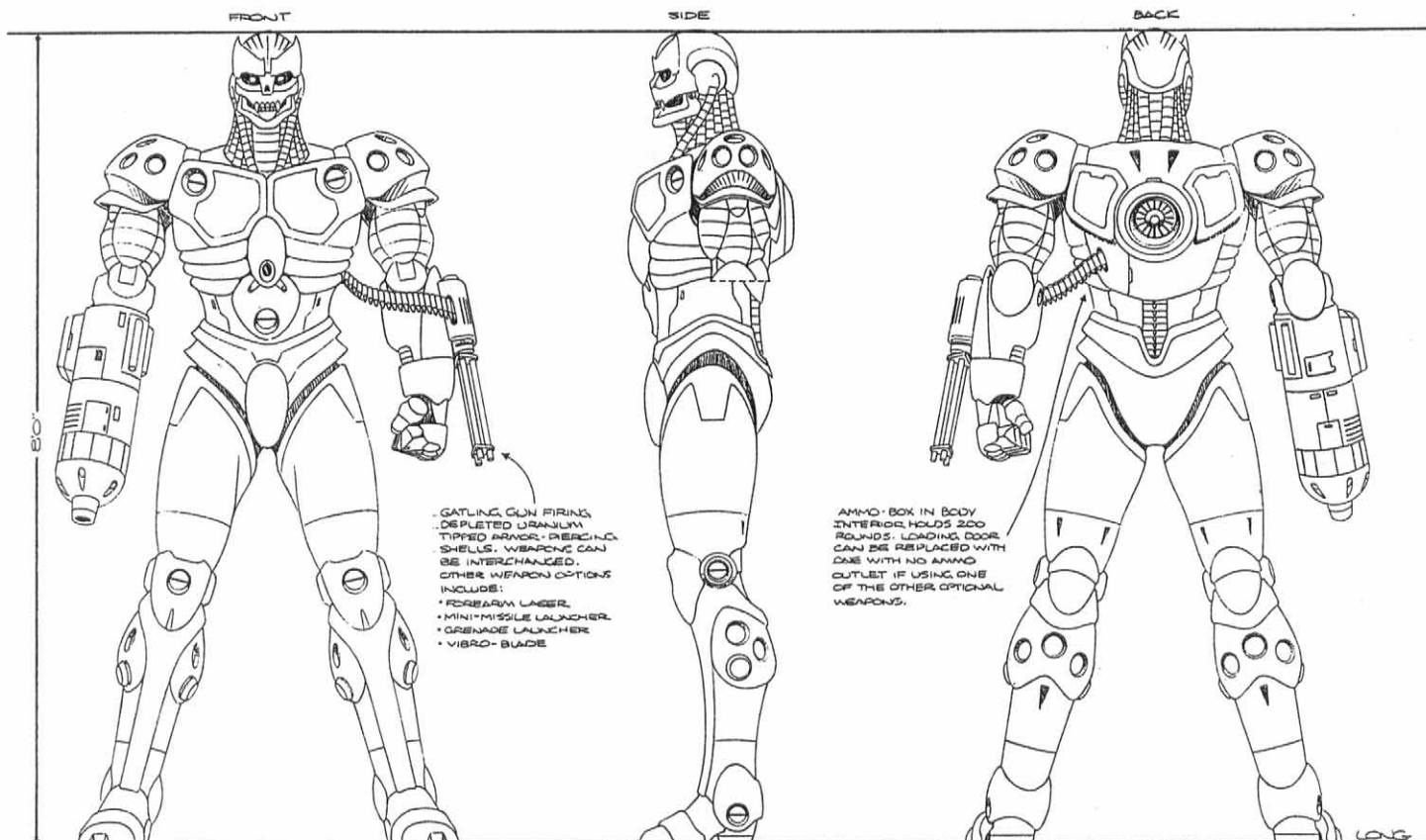

VX-370 Stopper (Blue Type)

The VX-370 Stopper is a full conversion cyborg also known as the “Blue Type” borg because mass market editions are usually a blue color (light to dark). The Stopper is a medium-heavy assault unit with medium armor and armaments. The bionic body is strong, fast and agile. The VX-370 also has a monstrous looking head to strike fear into his opponents.

Triax VX-370 Cyborg Soldier

Part of the NGR Military

Note: The following stats are for the “standard” VX-370 full conversion borg. Specific weapons and bionic features may change slightly from borg to borg.

Model Type: VX-370 Blue

Class: Full Conversion Cyborg — Medium-Heavy Assault

Crew: One human volunteer.

M.D.C. by Location:

Hand (1) — 15 each

Arms (2) — 50 each

Legs (2) — 80 each

*Head — 90 (reinforced)

**Main Body (standard) — 200 plus an additional 280 M.D.C. from its light infantry armor (hooks directly to the bionic body).

* Destroying the head of a cyborg will kill the character! However, the head is a small and difficult target to hit. The attacker must make a *called shot* and even then he is -3 to strike. The hands, and forearm guns are also difficult targets to hit and are -4 to strike on a called shot.

**Depleting the M.D.C. of the main body will effectively destroy the artificial body, but emergency systems will keep

the brain and vital organs alive for 36 hours. Recovery of the severely damaged body will enable doctors to place the character on a life support system that will keep him alive until a new bionic body (same style or other) is available for full conversion. Failure to find the damaged borg within 36 hours means the character dies. Similarly, massive amounts of damage (125 points below zero) completely destroys the borg with no hope for recovery.

Speed

Running: 100 mph (160 km) in the standard light infantry cyborg armor.

Leaping: The powerful bionic legs are strong and capable of leaping 15 feet (4.6 m) high or lengthwise. A running leap adds 30 additional feet (9 m).

Flying: Via jet pack only; see the T-100 Eagle jet pack.

Statistical Data

Average Height: 8 feet (2.4 m)

Width: 4 feet (1.2 m)

Length: 3 feet (0.9 m) is the length of the body itself.

Weight: 1400 lbs (630 kg)

Physical Attributes: Equal to a P.S. 27, P.P. 22, Spd. 154

Power System: Nuclear, average life is 20 years.

Market Cost: Five million credits with all standard features and weapons. Poor availability.

Penalties: The so-called light infantry armor provides excellent mega-damage protection but is actually quite heavy, so there are some movement penalties; -1 to parry and dodge, -1 to roll with impact, and -20% on prowl.

Standard Bionic Features (non-weapon types)

Note: These features are all found in the bionic and cybernetic sections of the **Rifts RPG**.

1. Bionic lung with gas filter & oxygen storage cell
2. Built-in language translator
3. Built-in loudspeaker
4. Built-in radio receiver & transmitter
5. Climb cord (concealed)
6. Clock calendar
7. Concealed energy-clip hand or arm port (1 in each arm)
8. Gyro-compass
9. Modulating voice synthesizer
10. Multi-optic eyes
11. Psionic electro-magnetic dampers
12. Universal headjack with amplified hearing and sound filtration

Weapon Systems

1. VX-370 Particle Beam Weapon Arm (1, standard issue):

The right or left forearm is a special particle beam weapon. Point and shoot.

Primary Purpose: Assault

Mega-Damage: 6D6 + 6 M.D. per blast.

Rate of Fire: Equal to the character's total number of hand to hand attacks per melee.

Effective Range: 1000 feet (305 m)

Payload: 50 shots. The VX-370 has an independent, regenerating power supply. Its energy payload recharges at a rate of 10 blasts per hour. In the meantime, a standard energy rifle E-clip can be inserted, providing 10 blasts per clip.

Penalty: -1 to strike and parry; the arm is heavy and a bit awkward.

2. VX-370 Mini-machinegun (1, standard issue):

This is a light forearm blaster.

Primary Purpose: Anti-personnel

Secondary Purpose: Defense

Weight: Gun-arm: 25 lbs (11 kg), ammo-drum: 40 lbs (18 kg).

The ammo-drum is hooked to the back of the body housing.

Mega-Damage: A full damage burst fires 30 rounds and inflicts 2D4 M.D.

Rate of Fire: Equal to the character's hand to hand attacks per melee round (usually 4 to 6).

Maximum Effective Range: 2000 feet (609 m)

Payload: The 2000 round drum is capable of firing 66 full bursts (30 rounds each).

Reloading a drum will take about three minutes for those not trained, but a mere 30 seconds by a capable field mechanic. A strength of 24 or higher is required to handle the drum.

Penalty: -1 to strike and parry; the arm is heavy and a bit awkward.

3. Concealed Leg Laser Rod (1):

The left hip contains a laser rod. Release, point and shoot.

Primary Purpose: Assault

Mega-Damage: 3D6 M.D. per blast.

Rate of Fire: Equal to the total number of hand to hand attacks.

Effective Range: 3000 feet (914 m)

Payload: 20 shots per E-clip.

4. Hand to Hand Combat:

Rather than use a weapon, the cyborg can engage in mega-damage hand to hand combat. Remember, although sheathed in M.D. body armor and weapons, the cyborg's physical strength is S.D.C. based except for the occasional special attack such as power punch.

Attacks per Melee Round: Equal to the character's hand to hand

combat skill selection and experience, plus one additional attack/action from heightened reflexes.

Combat Bonuses: +1 on initiative, +1 to pull punch, and +1 to save vs horror factor. P.P. 22 bonus: +4 to strike, parry and dodge.

Damage:

Restrained Punch — 1D6 + 12 S.D.C.

Full Strength Punch — 3D6 + 12 S.D.C.

Power Punch — 1D4 M.D. (counts as 2 melee attacks)

Head Butt — 2D6 S.D.C.

Kick — 4D6 + 12 S.D.C.

Jump Kick/Leap Attack — 2D4 M.D. (counts as 2 melee attacks)

Judo Style Throw/Flip — 3D6 S.D.C.

Full Speed Ram/Body Block — 1D4 M.D. (counts as 2 melee attacks)

5. Optional handheld weapons,

including rail guns, energy rifles, grenades, magic weapons, etc., can be used. Other bionic weapons or devices, such as concealed weapon rods, tools and compartments, may also be integrated into this borg.

6. Typical Training/Skills:

See the *Cyborg Soldier O.C.C.* for complete details. As for the VX-370, there are no special skill options.



VX-500 Manhunter (Red Type)

The VX-500 Manhunter full conversion cyborg is also known as the "Red Type" borg because it is made available to adventurers and mercenaries in the red color (It is interesting to note that the red color has become such a classic symbol of this borg's power and abilities that few buyers ever have it changed). Like the lighter, blue and gold types, the VX-500 has a monstrous looking head to strike fear into his opponents. This cyborg is heavily armored, strong and deadly.

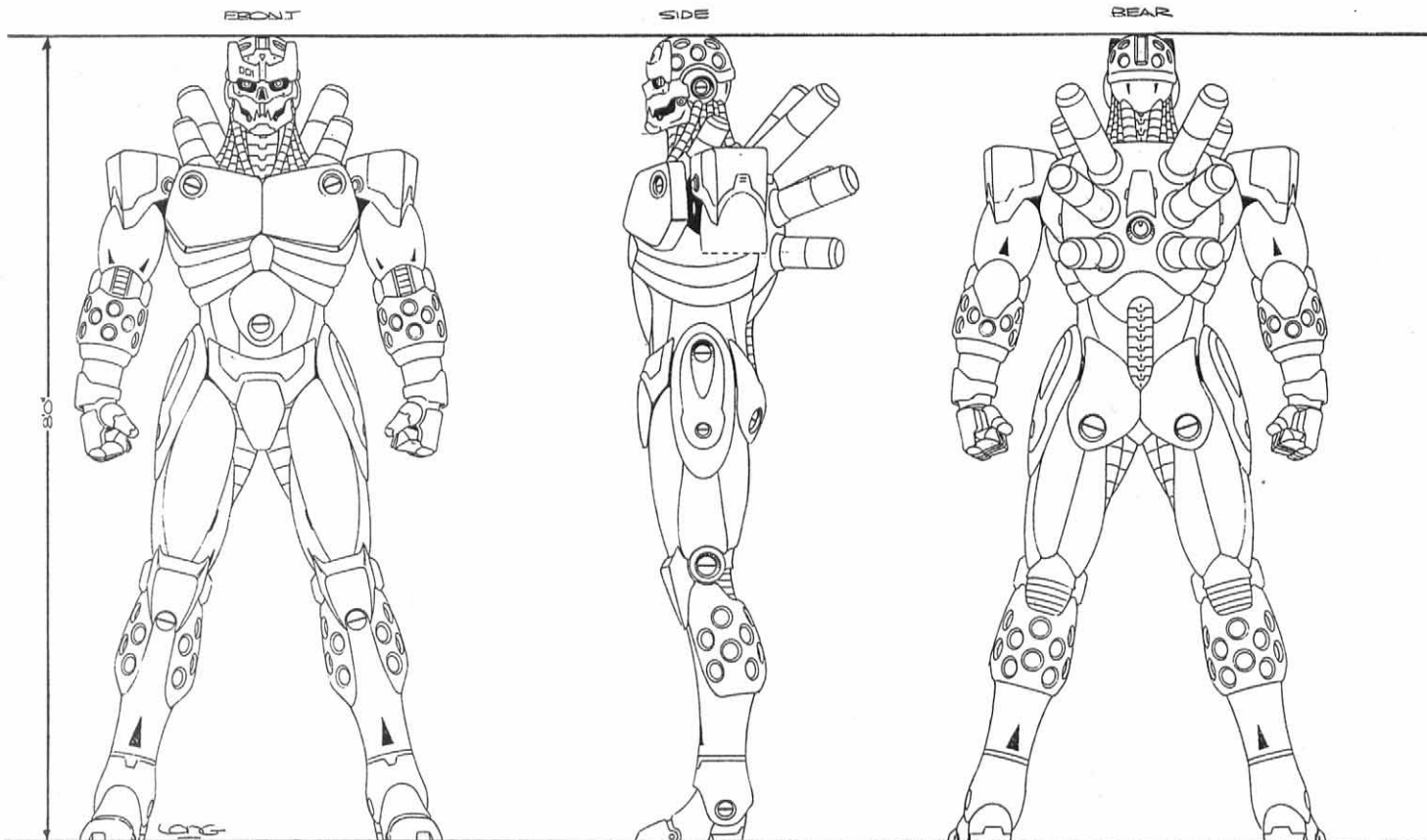

Triax VX-500 Cyborg Soldier

Part of the NGR Military

Note: The following stats are for the “standard” VX-500 full conversion borg. Specific weapons and bionic features may change slightly from borg to borg.

Model Type: VX-500 Red

Class: Full Conversion Cyborg — Heavy assault

Crew: One human volunteer.

M.D.C. by Location:

Hands (2) — 20 each

Arms (2) — 60 each

Mini-Missile Launch Tubes (6, back) — 25 each

TX-500 Rail Gun (1) — 75

Rail Gun Drum (1) — 75

Legs (2) — 100 each

*Head — 90 (reinforced)

**Main Body (normal) — 280 plus an additional 420 M.D.C. from its heavy infantry armor (hooks directly to the bionic body).

* Destroying the head of a cyborg will kill the character! However, the head is a small and difficult target to hit. The attacker must make a *called shot* and even then he is -3 to strike. The hands, and mini-missile launch tubes are also difficult targets to hit and are -4 to strike on a called shot.

**Depleting the M.D.C. of the main body will effectively destroy the artificial body, but emergency systems will keep the brain and vital organs alive for 36 hours. Recovery of the severely damaged body will enable doctors to place the character on a life support system that will keep him alive until a new bionic body (same style or other) is available for full conversion. Failure to find the damaged borg within 36 hours means the character dies. Similarly, massive amounts of dam-

age (125 points below zero) completely destroys the borg with no hope for recovery.

Speed

Running: 70 mph (112 km) in the standard heavy infantry armor or 100 mph (160 km) in light espionage armor.

Leaping: The powerful bionic legs are strong and capable of leaping is 25 feet (7.6 m) high or lengthwise. A running leap at adds 30 additional feet (9 m).

Flying: Via jet pack only; see the T-100 Eagle jet pack.

Statistical Data

Average Height: 8 feet (2.4 m)

Width: 4 feet (1.2 m)

Length: 3 feet (0.9 m) is the length of the body itself. Five feet (1.5 m) including the launch tubes.

Weight: 2000 lbs (900 kg)

Physical Attributes: Equal to a P.S. 30, P.P. 22, Spd. 100 with standard heavy armor or 154 with light espionage armor.

Power System: Nuclear, average life is 20 years.

Market Cost: Six to seven million credits with all standard features and weapons. Poor availability.

Penalties: The standard heavy armor provides incredible mega-damage protection but reduces the borg’s speed (see above), prowl is impossible, and the character is -2 to strike, parry, dodge and roll with impact.

Standard Bionic Features (non-weapon types)

Note: These features are all found in the bionic and cybernetic sections of the **Rifts RPG**.

1. Bionic lung with gas filter & oxygen storage cell
2. Built-in language translator
3. Built-in loudspeaker
4. Built-in radio receiver & transmitter
5. Climb cord (concealed)

6. Clock calendar
7. Concealed energy-clip hand or arm port (1 in each arm)
8. Concealed garrote wrist wire
9. Gyro-compass
10. Modulating voice synthesizer
11. Molecular analyzer
12. Multi-optic eyes
13. Psionic electro-magnetic dampers
14. Universal headjack with amplified hearing and sound filtration

Weapon Systems

1. TX-500 Triax Borg Rail Gun (1; standard issue): The TX-500 is a comparatively, lightweight, portable weapon designed for use by borgs and other creatures with a strength of 24 (or higher).

Weight: Gun: 80 lbs (36.3 kg), Power Pack: 50 lbs (22.7 kg), One light ammo-drum belt: 25 lbs (11 kg), a case of six light belts: 150 lbs (67.5 kg).

Mega-Damage: A full burst is 30 rounds and inflicts 6D6 M.D. A half burst is 15 rounds and inflicts 3D6 M.D. One round does 1D4 M.D. Depleted uranium rounds adds an additional 2D6 M.D. to a full burst or 1D6 M.D. to a half burst.

Rate of Fire: One burst per hand to hand melee action/attack.

Maximum Effective Range: 4000 feet (1200 m)

Payload: Heavy ammo-drum 1170 rounds (39 full 6D6 bursts), light drum/ammo-belt 390 rounds (13 full 6D6 bursts). Or it can be fitted with the mini-clip which contains 90 rounds (3 full bursts). Each mini-clip weighs 10 lbs (4.5 kg).

Market Cost: 85,000 credits. Fair availability.

Note: The TX-500 comes equipped with a telescopic, nightvision scope and laser targeting system. Bonus: +1 to strike.

2. VX-500 Mini-Missile Tube Launchers (6): Six mini-missile tube launchers, holding a total of 12 mini-missiles, are mounted on the back of the borg.

Primary Purpose: Anti-Aircraft

Secondary Purpose: Defense

Missile Type: Any mini-missile can be used, but standard issue is armor piercing (1D4 × 10 M.D.) or plasma (1D6 × 10). Fragmentation is seldom used by these anti-armor units.

Mega-Damage: Varies with missile type.

Range: Usually about a mile.

Rate of Fire: One at a time or volleys of two or three.

Payload: 12 total; two mini-missiles in each tube.

3. Concealed Leg Laser Rod (1): The right hip contains a laser rod. Release, point and shoot.

Primary Purpose: Assault

Mega-Damage: 3D6 M.D. per blast.

Rate of Fire: Equal to the total number of hand to hand attacks.

Effective Range: 3000 feet (914 m)

Payload: 20 shots per E-clip.

4. Concealed Leg Ion Rod (1): The left hip contains an ion rod. Release, point and shoot.

Primary Purpose: Assault

Mega-Damage: 4D6 M.D. per blast.

Rate of Fire: Equal to the total number of hand to hand attacks.

Effective Range: 2000 feet (610 m)

Payload: 20 shots per E-clip.

5. Hand to Hand Combat: Rather than use a weapon, the cyborg can engage in mega-damage hand to hand combat.

Remember, although sheathed in M.D. body armor and weapons, the cyborg's physical strength is S.D.C. based except for the occasional special attack, such as power punch.

Attacks per Melee Round: Equal to the character's hand to hand combat skill selection and experience, plus one additional attack/action from heightened reflexes.

Combat Bonuses: +1 on initiative, +2 to pull punch, and +1 to save vs horror factor. P.P. 22 bonus: +4 to strike, parry and dodge.

Damage:

Restrained Punch — 1D6 + 15 S.D.C.

Full Strength Punch — 4D6 + 15 S.D.C.

Power Punch — 1D6 M.D. (counts as 2 melee attacks)

Head Butt — 2D6 S.D.C.

Kick — 4D6 + 15 S.D.C.

Jump Kick/Leap Attack — 2D6 M.D. (counts as 2 melee attacks)

Judo Style Throw/Flip — 3D6 S.D.C.

Full Speed Ram/Body Block — 1D4 M.D. (counts as 2 melee attacks)

Garrote Strangle Attack — 4D6 + 15 S.D.C., plus 3D6 S.D.C. per each tightening movement/attack.

6. Optional handheld weapons, including rail guns, energy rifles, grenades, magic weapons, etc., can be used. Other bionic weapons and devices, such as concealed weapon rods, tools and compartments, may also be integrated into this borg.

7. Typical Training/Skills: See the *Cyborg Soldier O.C.C.* for complete details. As for the VX-500, there are no special skill options.

VX-635 Prowler

The Triax VX-635 Prowler is a member of the military Special Forces. The weapons and bionics are specifically designed with espionage and assassination in mind. Many of the borg's features are experimental and available only to the Prowler.

The typical agent must have a strong mental endurance (15 or higher) and undergo psychiatric evaluation before being allowed to become a VX-635 borg. Those who become a Prowler must be as mentally resilient (and often as cold) as the metal and mechanics that comprise their new body. The soldier is expected to serve in Special Forces as a Prowler borg for a minimum of seven years. At the end of that period the character can reenlist for another seven years, change his area of specialty, or quit. Under the latter two circumstances, the soldier is given a new, less powerful body, typically a VX-300 or VX-320. A dishonorable discharge will see the character transformed into a basic borg with only the most rudimentary bionic systems, without weapons or cyborg armor.

The VX-635 operative is placed in such sensitive and dangerous predicaments that they are expected to kill themselves or be killed rather than submit to the enemy. It is important to note that capture is NOT a prerequisite for self-destruction — if anybody can escape from the enemy, it's the Prowler. The military is more concerned with turncoats and the forcible extraction of information via torture. Consequently, the Prowler has two different brain implants that can be activated by the cyborg soldier or by his superiors. One is commonly called the "brain-

scrambler." Its activation puts the cyborg in an instant coma-like trance and scrambles his brain waves, making all psionic probes impossible (at best a tiny snippet of usable data out of a jumble of meaningless thoughts and images). Similarly, physical and mental torture, truth serums and other drugs have no effect on the comatose and scrambled individual. Anything that might be said is likely to be incoherent.

The second implant is a "termination mechanism," an explosive device that, to put it bluntly, will blow the borg's head off. It is detonated under the following conditions:

1. When the enemy tries to physically remove it.
2. When the enemy tries to physically remove the brain scrambler.
3. When the soldier activates the self-destruction mechanism. This also sets off the self-destruct mechanisms in his cyborg body, leaving little trace of any part of the borg.
4. When the soldier's military superiors agree that the borg has turned traitor and must be liquidated. This last circumstance requires five top ranking intelligence officers to review and discuss the case, probable scenarios, and possible alternatives (rescue, capture, etc.). Afterward, they make an evaluation, vote on termination or alternative action (majority rules), and initiates the appropriate action. All this is usually done within 72 hours, frequently within 50. The termination mechanism can be detonated up to 500 miles (800 km) away. Under most circumstances, the destruct command can be relayed throughout the NGR to cause the borg's termination anywhere within the country. The signal can remain active for 3D4 months, killing the Prowler the moment he sets foot within its borders.

If the termination subject is out of range and/or a "kill" cannot be confirmed, special agents (other Prowlers, intelligence officers, mercenaries or bounty hunters) are dispatched to hunt down and execute the rogue!

Triax VX-635 Cyborg Intelligence Soldier

Exclusive to the NGR Military

Note: The following stats are for the "standard" VX-635 Prowler, full conversion borg. Specific weapons and bionic features may change slightly from borg to borg. Also note that weapons and systems denoted with an asterisk are often experimental and available ONLY to the VX-635 Prowler. They are not available to other military or mass market borgs.

Model Type: VX-635

Class: Full Conversion Intelligence Cyborg (espionage)

Crew: One human volunteer.

M.D.C. by Location:

- Hand (1) — 20
- Left Arm (1) — 50
- Right Arm (1) — 40
- Concealed Mini-Arms (2; right) — 10 each
- Gun Arm (1; right) — 60
- Ammo-Drum (1; back) — 60
- Concealed Vibro-blade (1; left arm) — 10
- * Vibro-Bayonet (1; gun arm) — 15
- * Mini-Laser Turret (1; gun arm) — 10
- * Mini-Lasers on Head (2) — 3 each
- * Launchable Shoulder Spikes (12) — 1 each
- * Pneumatic Air Gun (1; shoulder) — 5
- * Pneumatic Blade Shooter (1; shoulder) — 5

Feet (2) — 30 each

Legs (2) — 75 each

* Leg Ring Lasers (1 each leg) — 5 each

* Telescopic Eye (1) — 10

* Rear Eyes/Optics (2) — 5 each

Head — 60 (reinforced)

**Main Body — 180 plus an additional 135 M.D.C. from light espionage body armor plates that hook directly to the bionic body.

Note: Destroying the head of a cyborg will kill the character! However, the head is a small and difficult target to hit. The attacker must make a *called shot* and even then he is -3 to strike. Also note that all the items marked with a single asterisk are tiny and/or difficult to hit. In these cases, the attacker must make a called shot and is -5 to strike.

**Depleting the M.D.C. of the main body will effectively destroy the artificial body, but emergency systems will keep the brain and vital organs alive for 36 hours. Recovery of the severely damaged body will enable doctors to place the character on a life support system that will keep him alive until a new bionic body (same style or other) is available for full conversion. Failure to find the damaged borg within 36 hours means the character dies. Similarly, massive amounts of damage (125 points below zero) completely destroys the borg with no hope for recovery.

Speed

Running: 120 mph (192 km) maximum

Leaping: The powerful bionic legs are strong and capable of leaping 20 feet (6 m) high or lengthwise. A running leap adds 30 feet (9 m).

Thruster Assisted Leaps: Four tiny thrusters are concealed in the lower portion of each leg. They are designed to be silent and they double the distance of a leap.

Flying: Via jet pack only.

Statistical Data

Average Height: 6 feet, 8 inches (2. m) from the top of the head to the bottom of the feet. The telescoping surveillance eye adds an extra foot (0.3 m) to the borg's height even when completely retracted and three feet (0.9 m) when fully extended.

Width: 3 feet (0.9 m)

Length: 2 feet (0.6 m).

Weight: 500 lbs (225 kg)

Physical Attributes: Equal to a P.S. 24, P.P. 24, Spd. 170

Power System: Nuclear, average life is 20 years.

Black Market Cost: Not available! Estimated worth: 50+ million credits just to be able to study and knock off the VX-635's many unique bionic systems. The optional molecular adhesion system is potentially worth hundreds of millions all by itself (which is why it is a carefully guarded secret).

Standard Bionic Features (non-weapon types)

Note: Most of these features are all found in the bionic and cybernetic sections of the **Rifts RPG**. Those that are not are briefly described under *Sensors & Features of Note* or in the cybernetics section of this book.

1. Bionic lung with gas filter & oxygen storage cell
2. Built-in language translator
3. Built-in radio receiver & transmitter
4. Climb cord (concealed)
5. Clock calendar

6. Concealed energy-clip hand or arm port (1)
7. Exploding finger segment (little finger only)
8. Finger camera (1)
9. Fingerjack (1)
10. Gyro-compass
11. Molecular analyzer
12. Modulating voice synthesizer
13. Multi-optic eyes
14. Psionic electro-magnetic dampers
15. Radar detector

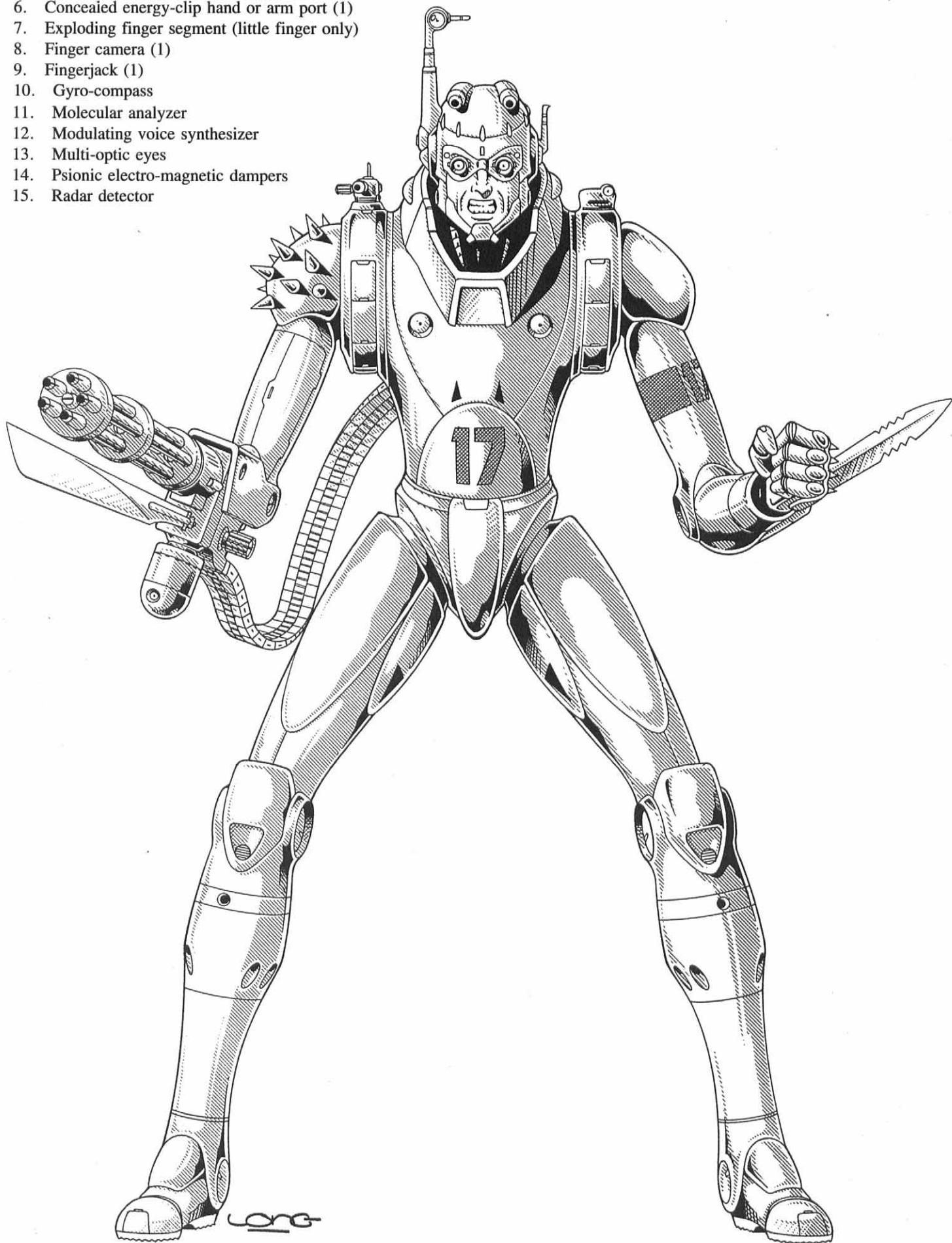

16. Rear optics located in the back of the head
17. Silenced leg thrusters for jet boosted leaps
18. Telescoping surveillance eye
19. Universal headjack with amplified hearing and sound filtration

Weapon Systems

1. VX-635 Multi-Weapon Gun-Arm (1, standard issue): This is a light, all-purpose weapon that is built directly into the borg as his right forearm. The weapon arm can be replaced by a mechanical human-like arm or other weapon arm as needed or desired.

A) Rail Gun

Primary Purpose: Assault

Secondary Purpose: Defense

Weight: Gun-arm: 60 lbs (27 kg), short clip: 10 pounds (4.5 kg), but the heavy ammo-drum is standard issue: 100 lbs (45 kg). The ammo-drum is hooked to the back of the body housing.

Mega-Damage: A full damage burst fires 20 rounds and inflicts 4D6 M.D.; a single round does two M.D. The weapon may also fire DU-rounds inflicting 5D6 M.D., or U-rounds also doing 5D6 M.D. (plus diminishes healing in supernatural beings).

Rate of Fire: Equal to the character's hand to hand attacks per melee round (usually 4 to 6).

Maximum Effective Range: 4000 feet (1200 m)

Payload: The short clip holds 200 rounds and is capable of firing ten full damage bursts (20 rounds).

The 2000 round drum is capable of firing 100 full damage bursts (20 rounds each).

Reloading a drum will take about three minutes for those not trained, but a mere 30 seconds by a capable field mechanic. A strength of 24 or higher is required to handle the drum.

B) Vibro-Bayonet: A large vibro-blade is built into the lower housing of the multi-weapon arm. It is used like a bayonet to stab or cut enemy attackers. It can also be fired once like an impaling rocket.

Primary Purpose: Defense

Mega-Damage: 2D6 M.D. per strike as a vibro-sword/bayonet or 6D6 M.D. as rocket fired projectile.

Attacks Per Melee Round: Same as any sword — equal to the total number of hand to hand attacks.

Rate of Fire: Once as a projectile

Effective Range: 300 feet (91.5 m) as a projectile.

Payload: Not applicable

Bonus: +1 to strike and parry.

C) Mini-Laser Turret: The tiny turret can rotate 360 degrees to fire upon the enemy in any direction.

Primary Purpose: Assault

Mega-Damage: 3D6 M.D. per blast.

Rate of Fire: Equal to the total number of hand to hand attacks.

Effective Range: 3000 feet (910 m)

Payload: Effectively unlimited.

Bonus: +1 to strike.

D) Utility Arms (2): Above the weapon arm is the connecting biceps area. A concealed door can open to release a pair of small utility arms and hands. These delicate appendages are used like normal human hands and are also used to pick locks, fire pistols, perform surgery or torture, climb, hold on, etc.

Primary Purpose: Tool/accessory.

Mega-Damage: None; a punch does 1D6 S.D.C.

P.S.: Equal to a P.S. 9.

Reach: Three feet (0.9 m)

Bonus: Whenever the arms are put to use, they add one melee action/attack per round. That's only one action even though there are two arms.

2. Launchable Shoulder Spikes (12): The right shoulder is covered in two to four inch spikes. These not only look menacing, hurt when struck by bare hands, but can be launched like tiny missiles.

Primary Purpose: Assault

Secondary Purpose: Create a distraction

Mega-Damage: One M.D. per spike.

Rate of Fire: One at a time or in volleys of two, four, eight or 12. A volley counts as one melee attack regardless of the number of projectiles launched in a single volley.

Effective Range: 200 feet (61 m)

Payload: 12

Penalty: -1 to strike.

3. VX-635 Pneumatic Air Gun (1): Mounted next to the right shoulder is a tiny air-powered turret that can fire a variety of items, few of which are lethal.

Primary Purpose: Surveillance

Mega-Damage & Types of Attacks: None; one S.D.C. point.

A) Dart — Sleep: A tiny dart treated with a tranquilizer will knock out a human target (and many D-bees) within 1D4 melee rounds (15 to 60 seconds). The victim will remain unconscious for 4D6 minutes. A successful save vs toxins/poison means the victim will only be knocked out for 1D4 melee rounds! Not effective against mega-damage creatures.

B) Dart — Poison: A tiny dart treated with a powerful poison takes effect after one melee round (15 seconds) and inflicts 1D6 × 10 S.D.C damage. A successful save vs poison means the victim suffers half damage. Not effective against mega-damage creatures.

C) Surveillance — Mini-Microphone: A tiny microphone, the size of a spider, is shot into the clothes or armor of another character. The borg can then eavesdrop on any conversations. Transmission range: 1000 feet (305 m). Transmission life: 24 hours.

D) Surveillance — Homing device: A tiny transmitter releases an ultrasonic signal that can be followed or traced wherever it goes. It can be shot into articles of clothing, furniture, seats of automobiles, onto armor, and moving vehicles. The borg can then track the signal to its current location. Transmission range: 2000 feet (609 m). Transmission life: 48 hours.

Rate of Fire: As many as two per melee action.

Effective Range: 200 feet (61 m). 500 feet (152 m) maximum, but at any distance beyond 200 feet, the borg is -3 to strike.

Payload: 12 of each type.

4. Head Mounted Mini-Lasers (1 pair): A pair of mini-lasers are mounted on the top of the cyborg's head. They can be used as both a tool or a weapon.

Primary Purpose: Assault

Mega-Damage: Two settings: 1D6 × 10 S.D.C. or 1D6 M.D. per single blast. The two lasers fired simultaneously at the same target inflict double damage, but only when an aimed shot is made.

Rate of Fire: Equal to the total number of hand to hand attacks.

Effective Range: 2000 feet (610 m)

Payload: Effectively unlimited.

Bonus: +1 to strike.

5. Pneumatic Blade Shooter (1): This weapon is used primarily against S.D.C. creatures such as fellow humans and many D-bees. The blades inflict S.D.C. damage and are often coated with a deadly toxin.

Primary Purpose: Assault

S.D.C. Damage Only: 3D4 S.D.C. per single blade, or 1D6 × 10 + 10 S.D.C. per single poison coated blade. The poison takes effect after one melee round (15 seconds). A successful save vs poison means the victim suffers half damage from the 1D6 × 10 poison but still suffers the full +10 S.D.C. from the blade itself. Not effective against mega-damage creatures.

Rate of Fire: One at a time (each counts as one melee attack/action) or in rapid-fire volleys of two (counts as one melee action).

Effective Range: 200 feet (61 m). 500 feet (152 m) maximum, but at any distance beyond 200 feet, the borg is -3 to strike.

Payload: 24 blades (poisoned or not).

6. RVB-31 Vibro-Blade (1): A standard vibro-blade short sword is concealed in a housing in the left forearm.

Mega-damage: 2D4 M.D.

Range: Hand to hand combat.

7. Extendable Hydraulic Hand (1): The left hand is connected to a hydraulic system similar to those used in the Flanker power armor. The hand can be extended three feet (0.9 m). The extendable hand enables the borg to reach into narrow places and reach items seemingly out of reach. Note that the vibro-blade is part of the forearm, not the extended hand. However, this hand does have a finger camera and a finger-jack.

8. VX-635 Ring Lasers (2): Each leg has a tiny, rotating laser that can swivel 180 degrees to fire upon the enemy.

Primary Purpose: Defense

Secondary Purpose: Create a distraction

Mega-Damage: 1D6 M.D. per blast.

Rate of Fire: Equal to the total number of hand to hand attacks.

Effective Range: 1000 feet (305 m)

Payload: Effectively unlimited.

9. Concealed Weapon Compartments: The standard VX-635 has two concealed compartments in the thighs of his legs. Each typically holds two fusion blocks or five hand grenades (any type), a laser scalpel (in one), and a lock picking/mini-tool kit (in the other) or an extra E-clip.

10. VX-635 Close Contact Spray (2): The two circular nozzles in the chest are connected to a liquid spray mechanism. Typically tear gas/mace, acid or water (against vampires) is sprayed from the concealed tanks.

Primary Purpose: Defense

Secondary Purpose: Create a distraction

Mega-Damage: Varies from none to little per spray.

Rate of Fire: Equal to the total number of hand to hand attacks.

Effective Range: 20 feet (6 m)

Payload: 20 total; ten per each nozzle.

11. LGL-35 Grapnel & Launcher (2): Near each underarm is a concealed compartment that contains a launcher that fires a grappling hook and line. The grappling hook is used to scale non-metallic surfaces or as a means to secure oneself to giant bots and vehicles.

Mega-Damage: None

Range: 100 feet (30.5 m) of lightweight cord (retractable) per each launcher.

12. Hand to Hand Combat: Rather than use a weapon, the cyborg can engage in mega-damage hand to hand combat. Remember, although sheathed in M.D. body armor and weapons, the cyborg's physical strength is S.D.C. based except for the occasional special attack, such as a power punch.

Attacks per Melee Round: Equal to the character's hand to hand combat skill selection and experience, plus two additional attack/actions from augmented reflexes and weapon systems.

Combat Bonuses: +7 to strike, parry and dodge! One additional attack/action per melee round. Cannot be surprised from behind. +5 on initiative, +3 to pull punch, +4 to roll with impact, +1 to save vs psionic attack and +1 to save vs horror factor. These include the P.P. of 24 and optic/sensor considerations, but does not include hand to hand combat bonuses.

Damage:

Restrained Punch — 1D6 + 9 S.D.C.

Full Strength Punch — 3D6 + 9 S.D.C.

Power Punch — 1D4 M.D. (counts as 2 melee attacks)

Power Stab with Vibro-Blade — 3D6 M.D. (counts as 2 melee attacks)

Power Stab with Vibro-Bayonet — 6D6 M.D. (counts as 2 melee attacks)

Head Butt — 2D6 S.D.C.

Kick — 3D6 + 9 S.D.C.

Jump Kick/Leap Attack — 1D6 M.D. (counts as 2 melee attacks)

Judo style throw/flip — 2D6 S.D.C.

13. Optional handheld weapons, including energy pistols, rifles, grenades, vibro-blade, magic weapons, etc., can be used. Other bionic weapons and devices, such as concealed weapon rods, tools and compartments, may also be integrated into this borg (although not likely).

14. Typical Training/Skills: See the *Cyborg Soldier O.C.C.* for complete details. In the case of VX-635 Prowler, at least three of the five (5) "other" O.C.C. related skills must be selected from the espionage category (not normally available to borgs). Each gets a bonus of +10%. Plus the character gets the skills: lock picking (+10%), prowl (+10%) and streetwise (+6%).

15. Sensors and Features of Note: 1) The Prowler has full optical systems, including laser targeting, telescopic, passive nightvision (light amplification), thermo-imaging, infrared, ultraviolet, and polarization.

2) Rear optics located in the back of the head. This is effectively a second pair of eyes and allows 360 degree vision. That makes sneaking up on the Prowler impossible and contributes to the character's combat bonuses.

3) A telescoping surveillance eye is located on the right side of the head and functions like a periscope, enabling the borg to peek above walls, around doorways and from protective cover without having to show himself. Furthermore, the tiny periscope is unlikely to be noticed by the enemy unless they are close-by or specifically looking for it. The surveillance eye has passive nightvision, infrared sight (used only in total darkness), targeting and telescopic (×10 magnification) capabilities. The eye can rotate 360 degrees and extend up to three feet (0.9 m).

4) The leg thrusters used for jet boosted leaps are designed to be silent and make only a slight whooshing sound.

5) The soles of the feet are made of a rubbery cushioned substance, have excellent grip, and are designed for stealth. They do not clank.

6) Optional: About 25% of the most trusted Prowlers have larger feet with the same molecular adhesion system as the T-31 Super Trooper. However, while excellent for scaling walls, the adhesion feet reduce speed by 10% and causes a -20% prowling penalty.

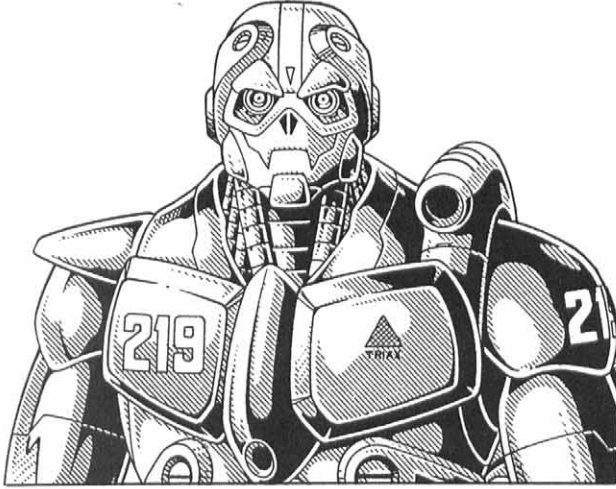

VX-2010 Marauder

The VX-2000 series is a new type of heavy combat cyborg. Unlike the more common borgs, these have no human features and are encased in a permanent, heavily armored body (no separate cyborg body armor that can be removed). To the untrained eye, they would appear to be powerful robots. It is only the cyborg's display of human ingenuity, quickness of thought and emotions that reveal their true nature. The Manhunter (VX-500) and some of the other large, full conversion borgs were leaning toward this type of design but even they have removable armor and a human face underneath the monstrous looking face plate.

The VX-2010 Marauder is the first of the new designs for full conversion cyborgs. It is ideal for heavy combat. The borg is bigger, heavier, physically more powerful, inflicts mega-damage even from normal kicks and punches, and offers an array of bionic weapons and features. On the negative side, the borg is slower, bulkier and its larger-than-human size (9 feet tall) can actually be a problem, particularly in urban environments. What concerns some people more than anything else is that the 2000 Series borgs seem to have lost all outer signs of their human origin.

Triax VX-2010 Cyborg Soldier

Exclusive to the NGR Military

Note: The following stats are for the "standard" VX-2010 full conversion borg. Specific weapons and bionic features may change slightly from borg to borg.

Model Type: VX-2010

Class: Full Conversion Cyborg — Heavy assault

Crew: One human volunteer.

M.D.C. by Location:

Shoulder Grenade Launcher (1) — 20

Vibro-Blades (2) — 10 each

TX-42 Laser Rifle (1, standard issue) — 30

Optional TX-41 Laser Rifle (1, giant) — 60

Optional TX-50 Rail Gun (1) — 75

Optional Rail Gun Drum (1) — 75

Hands (2) — 25 each

Arms (2) — 75 each

Legs (2) — 140 each

* Head — 100 (reinforced)

** Main Body (total armor) — 660

* Destroying the head of a cyborg will kill the character! However, the head is a small and difficult target to hit. The attacker must make a *called shot* and even then he is -3 to strike. The hands, forearm blades and grenade launcher are also difficult targets to hit and are -4 to strike on a called shot.

**Depleting the M.D.C. of the main body will effectively destroy the artificial body, but emergency systems will keep the brain and vital organs alive for 36 hours. Recovery of the severely damaged body will enable doctors to place the character on a life support system that will keep him alive until a new bionic body (same style or other) is available for full conversion. Failure to find the damaged borg within 36 hours means the character dies. Similarly, massive amounts of damage (125 points below zero) completely destroys the borg with no hope for recovery.

Speed

Running: 70 mph (112 km) maximum.

Leaping: The powerful bionic legs are strong and capable of leaping 25 feet (7.6 m) high or lengthwise. A running leap adds 30 feet (9 m).

Jet Assisted Leaps: Two large thrusters are located in the lower portion of each leg. These jets are designed to give the borg a boost to attain greater height and distance when leaping: 150 feet (45.7 m) high or lengthwise maximum.

Flying: Via jet pack only; see the T-100 Eagle jet pack, but reduce flight speed by half due to the borg's great weight and size.

Statistical Data

Average Height: 9 feet (2.7 m)

Width: 4 feet (1.2 m)

Length: 3 feet (0.9 m).

Weight: 2800 lbs (1260 kg)

Physical Attributes: Equal to a P.S. 40 (unique for borgs), P.P. 21, Spd. 96.

Power System: Nuclear, average life is 20 years.

Black Market Cost: Not available on the open market. Rare; eight million credits with all standard features and weapons.

Penalties: The heavy armor provides incredible mega-damage protection but limits the borg's maximum speed, prowling is impossible, and the character has penalties considered in its bonuses to strike, parry, dodge and roll with impact.

Standard Bionic Features (non-weapon types)

Note: These features are all found in the bionic and cybernetic sections of the **Rifts RPG**.

1. Bionic lung with gas filter & oxygen storage cell
2. Built-in language translator
3. Built-in loudspeaker
4. Built-in radio receiver & transmitter

5. Climb cord (concealed)
6. Clock calendar
7. Concealed energy-clip hand or arm port (1 in each arm)
8. Gyro-compass
9. Modulating voice synthesizer
10. Multi-optic eyes
11. Psionic electro-magnetic dampers
12. Universal headjack with amplified hearing and sound filtration

Weapon Systems

1. TX-42 Laser Pulse Rifle: This is the standard energy assault weapon used by the human-size troops of the NGR armed forces.

The weapon is also a variable light frequency laser with 12 different settings. The operator can change frequencies with a touch or voice command. An internal computer makes the desired change. Number 7 counters the USA-10 Glitter Boy. The other settings are able to overcome other laser resistant armor.

Primary Purpose: Assault

Mega-Damage: 2D6 M.D. per single shot or 1D4 × 10 M.D. per rapid-fire pulse (three nearly simultaneous blasts fired one micro-second after the other).

Rate of Fire: Equal to the total number of hand to hand attacks.

Effective Range: 2000 feet (610 m)

Payload: 40: A large energy clip is located in the front of the gun. A second E-clip is concealed in one of the secret chest compartments.

Note: The VX-2010 is large enough and strong enough to use the giant-sized TX-41 as a two-handed assault rifle.

2. VX-20 Grenade Launcher (1): On the left side of the neck collar is a grenade launcher. This is a short-range, anti-personnel weapon that can fire explosive, plasma, smoke, or riot control grenades.

Primary Purpose: Anti-Personnel

Secondary Purpose: Defensive Cover

Grenade Type & Mega-Damage: Varies; typically includes fragmentation (2D6 M.D. inflicted to a 20 foot/6 m radius), plasma (5D6 M.D. covering 12 foot/3.6 m diameter), smoke (no damage), or riot control/tear gas/stun (see the Flanker for grenade descriptions).

Maximum Range: 300 (91.5 m)

Rate of Fire: One at a time or in volleys of two or three fired in rapid succession.

Payload: 48 total. Typically 2 smoke, 4 tear gas, 22 plasma and 20 fragmentation.

3. VX-2000 Concealed Ion Blasters (2): The heavy chest plates slide open to reveal a pair of heavy-duty, short-range ion blasters.

Primary Purpose: Anti-personnel

Mega-Damage: 4D6 M.D. per single blast or 1D4 × 10 + 6 per twin blasts.

Rate of Fire: Equal to the total number of hand to hand attacks.

Effective Range: 1000 feet (305 m)

Payload: Effectively unlimited; patched into the borg's power supply.

4. Concealed Leg Laser Rod (1): The right leg contains a laser rod. Release, point and shoot.

Primary Purpose: Assault

Mega-Damage: 3D6 M.D. per blast.

Rate of Fire: Equal to the total number of hand to hand attacks.

Effective Range: 3000 feet (914 m)

Payload: Effectively unlimited; patched into the borg's power supply.

5. Concealed Vibro-Blades (2): A large vibro-sword is concealed in a housing in each arm.

Mega-damage: 2D6 M.D.

Range: Hand to hand combat.

6. Concealed Storage Compartment (1): The upper left leg has a concealed storage compartment that typically holds an extra E-clip for the TX-42 or TX-41 pulse rifle, four hand grenades or one fusion block. Other items can be substituted.

7. Hand to Hand Combat: Rather than use a weapon, the cyborg can engage in mega-damage hand to hand combat. Unlike the typical borg, including the VX-500, the 2000 series can inflict mega-damage from their punches and kicks!

Attacks per Melee Round: Equal to the character's hand to hand combat skill selection and experience, plus one additional attack/action from heightened reflexes.

Combat Bonuses: +4 to strike and parry, +3 to dodge, +1 on initiative, +2 to pull punch, +2 to roll with impact, +1 to save vs psionic attack and +1 to save vs horror factor (includes the P.P. 21 bonus and optic/sensor considerations)

Damage:

Restrained Punch — 1D6 + 25 S.D.C.

Full Strength Punch — 1D6 M.D.

Power Punch — 2D6 M.D. (counts as 2 melee attacks)

Head Butt — 1D4 M.D.

Kick — 1D6 M.D.

Jump Kick/Leap Attack — 2D6 M.D. (counts as 2 melee attacks)

Judo Style Throw/Flip — 1D4 M.D.

Full Speed Ram/Body Block — 1D4 M.D. (counts as 2 melee attacks)

8. Optional handheld weapons, including rail guns, energy rifles, grenades, magic weapons, etc. can be used. Other bionic weapons and devices, such as concealed weapon rods, tools and compartments, may also be integrated into this borg.

9. Typical Training/Skills: See the *Cyborg Soldier O.C.C.* for complete details. As for the VX-2010, there are no special skill options.

VX-2020 Monster

The VX-2020 Monster is a slightly more powerful variation of the VX-2010. This full conversion borg is big, more heavily armored, and has an additional sensor array that includes a short-range radar system similar to those used in robots and power armor.

Triax VX-2020 Cyborg Soldier

Exclusive to the NGR Military

Note: The following stats are for the "standard" VX-2020 full conversion borg. Specific weapons and bionic features may change slightly from borg to borg.

Model Type: VX-2020

Class: Full Conversion Cyborg — Heavy assault

VX-2010

VX-2020

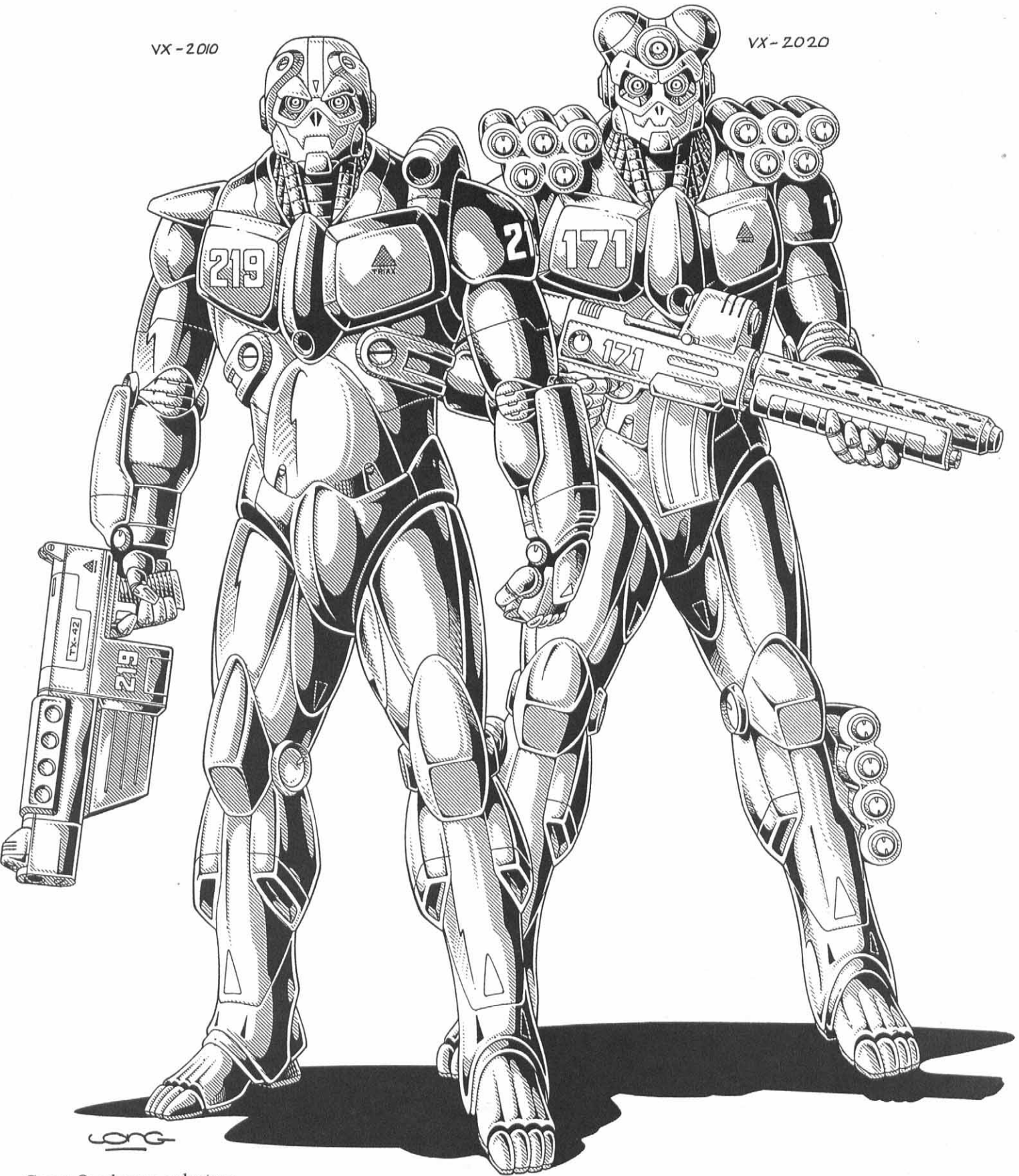

Crew: One human volunteer.

M.D.C. by Location:

- Shoulder Missile Launchers (2) — 30 each
- Leg Missile Launchers (2) — 20 each
- Vibro-Blades (2) — 10 each
- TX-42 Laser Rifle (1, standard issue) — 30

- Optional TX-41 Laser Rifle (1, giant) — 60
- Optional TX-50 Rail Gun (1) — 75
- Optional Rail Gun Drum (1) — 75
- Hands (2) — 25 each
- Arms (2) — 75 each

Legs (2) — 140 each

*Head — 120 (reinforced)

** Main Body (total armor) — 680

* Destroying the head of a cyborg will kill the character! However, the head is a small and difficult target to hit. The attacker must make a *called shot* and even then he is -3 to strike. The hands, forearm blades and mini-missile launchers are also difficult targets to hit and are -4 to strike on a called shot.

**Depleting the M.D.C. of the main body will effectively destroy the artificial body, but emergency systems will keep the brain and vital organs alive for 36 hours. Recovery of the severely damaged body will enable doctors to place the character on a life support system that will keep him alive until a new bionic body (same style or other) is available for full conversion. Failure to find the damaged borg within 36 hours means the character dies. Similarly, massive amounts of damage (125 points below zero) completely destroys the borg with no hope for recovery.

Speed

Running: 70 mph (112 km) maximum.

Leaping: The powerful bionic legs are strong and capable of leaping 25 feet (7.6 m) high or lengthwise. A running leap adds 30 feet (9 m).

Jet Assisted Leaps: Two large thrusters are located in the lower portion of each leg. These jets are designed to give the borg a boost to attain greater height and distance when leaping: 150 feet (45.7 m) high or lengthwise maximum.

Flying: Via jet pack only; see the T-100 Eagle jet pack, but reduce flight speed by half due to the borg's great weight and size.

Statistical Data

Average Height: 9 feet (2.7 m)

Width: 4 feet (1.2 m)

Length: 3 feet (0.9 m).

Weight: 3200 lbs (1440 kg)

Physical Attributes: Equal to a P.S. 40 (unique for borgs), P.P. 21, Spd. 96.

Power System: Nuclear, average life is 20 years.

Black Market Cost: Not available on the open market. Rare; eight million credits with all standard features and weapons.

Penalties: The heavy armor provides incredible mega-damage protection but limits the borg's maximum speed, prowling is impossible, and the character has penalties factored into the bonuses to strike, parry, dodge and roll with impact.

Standard Bionic Features (non-weapon types)

Note: These features are all found in the bionic and cybernetic sections of the **Rifts RPG**.

1. Bionic lung with gas filter & oxygen storage cell
2. Built-in language translator
3. Built-in loudspeaker
4. Built-in radio receiver & transmitter
5. Climb cord (concealed)
6. Clock calendar
7. Concealed energy-clip hand or arm port (1 in each arm)
8. Gyro-compass
9. Modulating voice synthesizer
10. Multi-optic eyes
11. Psionic electro-magnetic dampers
12. Radar (short range)

13. Rear optics in the back of the head

14. Universal headjack with amplified hearing and sound filtration

Weapon Systems

1. TX-50 Rail gun (1): This is a light, all-purpose weapon used by cyborgs and human troops wearing T-11 Enhanced body armor and power armor. A heavy, belt feed drum containing 2000 rounds (100 bursts) is standard issue.

Primary Purpose: Assault

Secondary Purpose: Defense

Weight: Gun: 60 lbs (27 kg), short clip: 10 pounds (4.5 kg), light ammo-drum: 30 pounds (13 kg) or a heavy ammo-drum: 100 lbs (45 kg). Ammo-drums are hooks to the back of the body armor or housing on the back of bots.

Mega-Damage: A full damage burst fires 20 rounds and inflicts 4D6 M.D.; a single round does 1D4 M.D.

Rate of Fire: Equal to the character's hand to hand attacks per melee round (usually 3 to 6).

Maximum Effective Range: 4000 feet (1200 m)

Payload: The short clip holds 200 rounds and is capable of firing ten full damage bursts (20 rounds).

The light drum holds 600 rounds and can fire 30 bursts.

The 2000 round drum is capable of firing 100 full damage bursts (20 rounds each).

Reloading a drum will take about three minutes for those not trained, but a mere 30 seconds by a capable field mechanic. A strength of 24 or higher is required to handle the drum.

Special TX-50 Feature: 1) The TX-50 rail gun for human troops has its own laser targeting/distancing, telescopic sight and night-vision scope. Telescopic and laser targeting range is 6000 feet (1828 m). Bonus: +1 to strike.

2. Mini-Missile Tube Launchers (18): Several mini-missile launch tubes are mounted on the shoulders and lower legs. Each fires one missile.

Primary Purpose: Anti-Aircraft

Secondary Purpose: Defense

Missile Type: Any mini-missile can be used, but standard issue is armor piercing (1D4 × 10 M.D.) or plasma (1D6 × 10). Fragmentation is seldom used by these anti-armor units.

Mega-Damage: Varies with missile type.

Range: Usually about a mile.

Rate of Fire: One at a time or volleys of two, three or four.

Payload: 18 total; five on each shoulder and four on each leg.

3. VX-2000 Concealed Ion Blasters (2): The heavy chest plates slide open to reveal a pair of heavy-duty, short-range ion blasters.

Primary Purpose: Anti-personnel

Mega-Damage: 4D6 M.D. per single blast or 1D4 × 10 + 6 per twin blasts.

Rate of Fire: Equal to the total number of hand to hand attacks.

Effective Range: 1000 feet (305 m)

Payload: Effectively unlimited; patched into the borg's power supply.

4. VX-270 Concealed Particle Beam Weapon Rod (1, standard issue): The right or left leg contains a concealed particle beam weapon similar to the arm weapon in the VX-370. Release, point and shoot.

Primary Purpose: Assault

Mega-Damage: 6D6 + 6 M.D. per blast.

Rate of Fire: Equal to the character's total number of hand to hand attacks per melee.

Effective Range: 1000 feet (305 m)

Payload: 36 shots. Although patched into the borg's power supply, the powerful beam draws a great amount of energy. Its energy payload recharges at a rate of 8 blasts per hour.

5. Concealed Vibro-Blades (2): A large vibro-sword is concealed in a housing in each arm.

Mega-damage: 2D6 M.D.

Range: Hand to hand combat.

6. Concealed Storage Compartment (1): The upper left leg has a concealed storage compartment that typically holds an extra E-clip for the TX-42 or TX-41 pulse rifle, four hand grenades or one fusion block. Other items can be substituted.

7. Hand to Hand Combat: Rather than use a weapon, the cyborg can engage in mega-damage hand to hand combat. Unlike the typical borg, including the VX-500, the 2000 series can inflict mega-damage from their punches and kicks!

Attacks per Melee Round: Equal to the character's hand to hand combat skill selection and experience, plus one additional attack/action from heightened reflexes.

Combat Bonuses: +5 to strike, +4 to parry and dodge +3 on initiative, +2 to pull punch, +2 to roll with impact, +1 to save vs psionic attack and +1 to save vs horror factor (includes the P.P. 21 bonus and optic/sensor considerations). The character cannot be surprised by attacks from behind.

Damage:

Restrained Punch — 1D6 + 25 S.D.C.

Full Strength Punch — 1D6 M.D.

Power Punch — 2D6 M.D. (counts as 2 melee attacks)

Head Butt — 1D4 M.D.

Kick — 1D6 M.D.

Jump Kick/Leap Attack — 2D6 M.D. (counts as 2 melee attacks)

Judo Style Throw/Flip — 1D4 M.D.

Full Speed Ram/Body Block — 1D4 M.D. (counts as 2 melee attacks)

8. Optional handheld weapons including rail guns, energy rifles, grenades, magic weapons, etc., can be used. Other bionic weapons and devices, such as concealed weapon rods, tools and compartments, may also be integrated into this borg.

9. Typical Training/Skills: See the *Cyborg Soldier O.C.C.* for complete details. As for the VX-2020, there are no special skill options.

10. Sensors and Features of Note: 1) The Monster has full optical systems, including laser targeting, telescopic, passive nightvision (light amplification), thermo-imaging, infrared, ultraviolet, and polarization.

2) Rear optics located in the back of the head. This is effectively a second pair of eyes and allows 360 degree vision. That makes sneaking up on the Monster impossible and contributes to the character's combat bonuses.

3) The additional sensor array on the head contains the rear eyes and the majority of the optics and sensors. It also includes a short-range radar system similar to those used in power armor. It can identify and track up to 24 targets simultaneously and has a range of 10 miles (16 km).

Weapons & Equipment

Triax Combat Vehicles

In addition to the multitude of robot, cyborg and power armor troops, Triax has developed and manufactures a variety of military tanks and vehicles. The most notable are presented below.

XM Series Military Vehicles

XM-50 Medic Ambulance Pod

XM-60 Field Mechanic Pod

XM-70 Covert Operations Pod

XM-140 Infantry Support Hover Platform

XM-170 Infantry Repair Barge

XM-180 "Dragonfly" Power Armor & Bot Drop Ship

XM-250 Medical Hover Station

XM-270 "Mosquito" VTOL Airship

XM-275 "Lightning" VTOL Combat Jet

XM-280 Fighter Jet

XM-288 Supersonic Transport

XM-300 "Terror" Mini-Tank

XM-330 "Phantom" Hover Tank

XM-350 Leopard III APC

Other Vehicles of Note

Triax MZ-10 Armored All-Terrain Vehicle

WR-1010 Land Rover

WR-2020 Bullet Bike

WR-5050 Super Cargo Hauler & APC

WR-5054 Mini-Cargo Hauler APC

XM-50 Medic Ambulance Pod

Triax has developed a small, speedy, one man, hover vehicle usually referred to as a "pod" because of its roundness and soft edges. There are three "pods" currently available: The medic's pod, field mechanic's pod and covert operations' pod. All are very similar in basic features, with minor changes and modifications to reflect the needs of the soldiers who use them.

The Medic Ambulance Pod is used by medical field personnel. The trusty vehicle can race along close to the ground or several hundred feet in the air.

Model Type: XM-50

Class: Military Vehicle

Crew: One

M.D.C. by Location:

- * Forward Headlights (2) — 5 each
- * Lower Tail Fin (1) — 30
- * Lower Maneuvering Jets (4) — 30 each
- Lower Light Turret (1) — 50
- * Lower Turret Lights (2) — 10 each
- Extendable Stretcher (1) — 50
- * Rear Laser Turret (1) — 12
- * Storage Bays (5) — 20 each
- Force Field — 80
- ** Main Body — 140

* Every item marked by a single asterisk is small and/or difficult to strike. An attacker must make a called shot to hit even then he is -3 to strike. Destroying the tail fin makes the vehicle's flight wobbly (-10% on skill proficiency) and reduces the vehicle's speed by 10%. Reduce the vehicle's speed and altitude by 25% for each thruster that is destroyed. If all four thrusters are destroyed the vehicle is crippled and cannot fly.

** Depleting the M.D.C. of the main body completely destroys the vehicle.

Speed

Flying: The propulsion system enables the vehicle to hover in a stationary position or fly. Maximum flying speed is 60 mph (96 km), but cruising speed is usually around 45 mph (76 km) and considerably slower when searching the battlefield for the injured. The pod can hover a few feet above the ground or up to 500 feet (152 m) in the air.

Flying Range: Effectively unlimited.

Statistical Data

Height: 4 feet (1.2 m) from tail tip to the top of the windshield.

Width: 3 feet, six inches (1 m)

Length: 6 feet (1.8 m) or 12 feet (3.6 m) with the stretcher extended.

Weight: 800 lbs (360 kg)

Cargo: Five storage bays to hold additional equipment and supplies.

Color: Light grey or white with a large red "cross" on both sides of the vehicle.

Power System: Nuclear, average energy life is 10 years.

Black Market Cost: 500,000 credits. Poor availability.

XM-50: Special Features

1. **Searchlight Turret (1):** In addition to the high-intensity headlights in the front of the pod, it also has a lower turret with a pair of searchlights. One light is a high-intensity incandescent searchlight while the other is infrared. The infrared beam is invisible to most humans, D-bees and many monsters without the aid of optical enhancements. It is typically used at night. Both light beams are used to sweep battle sites in the search for injured soldiers. The lights are built into a turret that can rotate 360 degrees and the spotlights can be raised and lowered 45 degrees.

2. **Mini-Laser Defense Turret (1):** Located in the rear of the pod, behind the seat of the driver is a small laser turret. The brodkil, gargoyles and many other monsters do not acknowledge or respect the symbols of the doctor or ambulance.

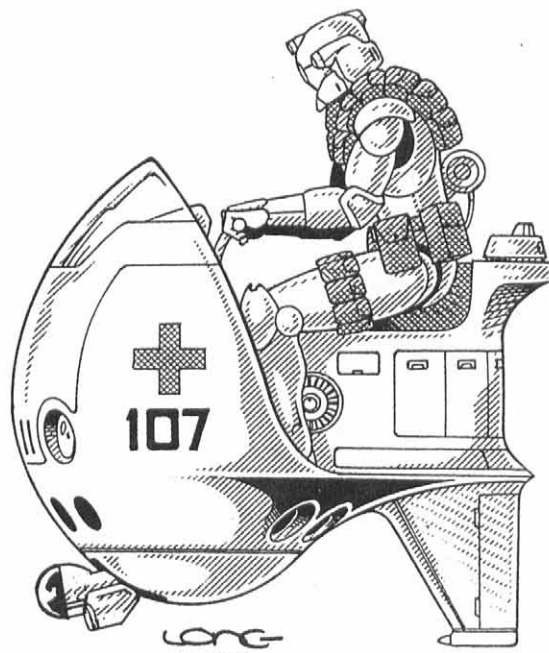

To them, all humans are an enemy to destroy; they do not allow doctors, nurses or ambulances to pass unmolested. Consequently, even the XM-50 Medic Pod is equipped with a *defensive* weapon such as the mini-laser turret. The turret is especially effective against missile attacks and to deter attacks from behind.

Primary Purpose: Anti-Missile

Secondary Purpose: Defense

Mega-Damage: 2D6 M.D. per blast

Rate of Fire: Usually set on automatic defense and firing five times per melee round.

Maximum Effective Range: 1200 feet (366 m)

Payload: Effectively unlimited.

3. **Extendable Stretcher (1):** Located in the lower rear portion of the Medic Ambulance Pod is a concealed stretcher that can be extended and retracted as needed. The stretcher is only large enough to accommodate one prone patient or three sitting. Maximum weight allowance without impairing the speed or movement is 800 pounds (360 kg). An additional 800 pounds (360 kg) can be carried but every 200 additional pounds (90 kg) reduces maximum altitude by 100 feet (30.5 m) and speed by 20%!

4. **Rechargeable Force Field:** A small, rechargeable force field generator is part of the XM-50's features. It is designed to protect the vehicle, pilot and injured passengers from enemy attack. However, the use of the force field reduces the maximum flight speed to 40 mph (64 km). Once depleted, it takes a full 24 hours for the field to recharge.

M.D.C. of Force Field: 80

5. **Five Storage Bays:** The Medic's Pod has five storage bays. Each is large enough to hold a medium size backpack or equivalent amount of equipment. This usually includes basic medical gear such as oxygen, surgical equipment, medication, medical kit, suture gun, bandages, nano-medical robots, portable scanners, bio-computers, and so on. 1D4 parachute flares, four signal flares and 1D4 smoke grenades are also commonly counted among the medical supplies.

6. **Distress Homing Beacon:** All XM-50's are equipped with a scrambled, radio homing signal used for extraction from combat zones. Before the gargoyles, brodkil and other

monsters began to use modern equipment, the homing signal was completely undetectable by them. As they become increasingly familiar with high technology, the enemy has a 30% chance of tracing the signal.

XM-60 Field Mechanic Pod

The mechanic's pod is very similar to the ambulance pod with certain features made to accommodate the needs of a field mechanic. It is slightly larger and heavier than the medical pod. The force field has been forsaken for stronger thrusters and a greater weight capacity for carrying parts. The vehicle can race along close to the ground or several hundred feet in the air.

Model Type: XM-60

Class: Military Vehicle

Crew: One

M.D.C. by Location:

- * Forward Headlights (2) — 5 each
- * Lower Tail Fin (1) — 30
- * Lower Maneuvering Jets (4) — 35 each
- Lower Weapon Turret (1) — 50
- Gun Barrel from Turret (1) — 25
- Extendable Storage Rack (1) — 60
- Metal Mesh Storage Bags (3) — 25 each
- * Rear Laser Turret (1) — 12
- * Storage Bays (5) — 25 each
- ** Main Body — 160

* Every item marked by a single asterisk is small and/or difficult to strike. An attacker must make a called shot to hit even then he is -3 to strike. Destroying the tail fin makes the vehicle's flight wobbly (-10% on skill proficiency) and reduces the vehicle's speed by 10%. Reduce the vehicle's speed and altitude by 25% for each thruster that is destroyed. If all four thrusters are destroyed the vehicle is crippled and cannot fly.

** Depleting the M.D.C. of the main body completely destroys the vehicle.

Speed

Flying: The propulsion system enables the vehicle to hover in a stationary position or fly. Maximum flying speed is 60 mph (96 km), but cruising speed is usually around 45 mph (76 km) and considerably slower when searching the battlefield for the injured. The pod can hover a few feet above the ground or up to 500 feet (152 m) in the air.

Flying Range: Effectively unlimited.

Statistical Data

Height: 4 feet (1.2 m) from tail tip to the top of the windshield.

Width: 4 feet (1.2 m)

Length: 7 feet (2.1 m) or 13 feet (3.9 m) with the storage rack extended.

Weight: 900 lbs (405 kg)

Cargo: Five storage bays to hold additional equipment and supplies.

Color: Light grey, dark grey, blue or camouflage.

Power System: Nuclear, average energy life is 10 years.

Black Market Cost: 500,000 credits. Poor availability.

XM-60: Special Features

1. **Pulse Laser Turret (1):** The field mechanic is often in the thick of action during and after combat, thus he is provided with a weapon turret to defend himself against the enemy. The turret housing can rotate 360 degrees and the weapon barrel can be raised and lowered 45 degrees.

Primary Purpose: Defense

Mega-Damage: 2D6 M.D. per single blast or 6D6 per triple pulse (the pulse counts as one melee action).

Rate of Fire: Equal to the pilot's attacks/actions per melee.

Maximum Effective Range: 2000 feet (610 m)

Payload: Effectively unlimited.

2. **Rear Laser Turret (1):** Located in the rear of the pod, behind the seat of the driver is a small laser turret. The turret is especially effective against missile attack and to deter attacks from behind.

Primary Purpose: Anti-Missile

Secondary Purpose: Defense

Mega-Damage: 2D6 M.D. per blast

Rate of Fire: Usually set on automatic defense and firing five times per melee round.

Maximum Effective Range: 1200 feet (366 m)

Payload: Effectively unlimited.

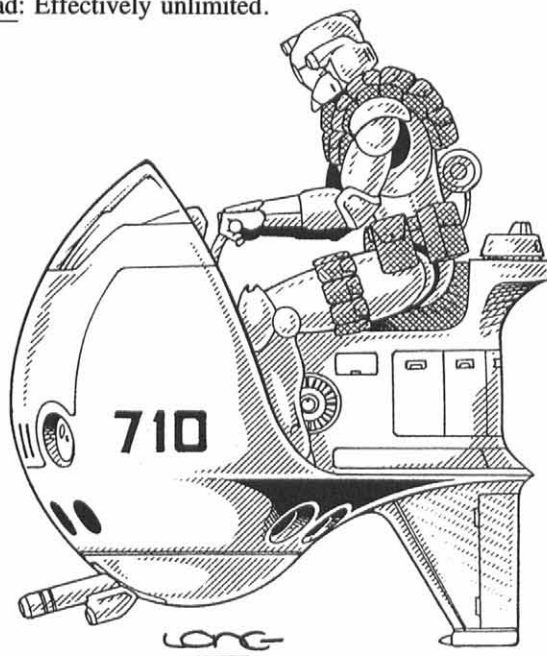

3. **Extendable Storage Rack (1):** Located in the lower rear portion of the XM-60 Mechanic Pod is a concealed rack that can be extended and retracted when empty. Three large, mesh sacks dangle from beneath the retractable rack, resembling giant garbage bags. The bags can be filled with parts to be taken into combat or supply zones or used to put salvaged parts into from the battlefield. There is also a hook that can hold most man-sized power armor.

Maximum weight allowance without impairing the speed or movement is 2000 pounds (900 kg). An additional 1200 pounds (540 kg) can be carried but every additional 400 pounds (180 kg) reduces maximum altitude by 100 feet (30.5 m) and speed by 20%!

4. **Five Storage Bays:** The pod has five storage bays. Each is large enough to hold a medium size backpack or equivalent amount of equipment. This usually includes tools, lights, and

parts. 1D4+2 parachute flares, six signal flares and 1D4+2 smoke grenades are also commonly counted among the equipment.

5. Distress Homing Beacon: All XM-60's are equipped with a scrambled, radio homing signal used for extraction from combat zones. Before the gargoyles, brodkil and other monsters began to use modern equipment, the homing signal was completely undetectable by them. As they become increasingly familiar with high technology, the enemy has a 30% chance of tracing the signal.

XM-70 Covert Operations Pod

This vehicle is designed with intelligence operations in mind. The force field has been forsaken for greater speed. There is no signal beacon either. The extendable table or rack has been replaced with a pair of rear boosters for additional speed.

Model Type: XM-70

Class: Military Intelligence Vehicle

Crew: One

M.D.C. by Location:

- * Forward Headlights (2) — 5 each
- * Lower Tail Fin (1) — 30
- * Lower Maneuvering Jets (4) — 30 each
- * Rear Jets (2; lower) — 30 each
- * Lower Weapon Turret (1) — 60
- * Lower Gun Barrel from Turret (1) — 25
- * Rear Laser Turret (1) — 12
- * Storage Bays (4) — 20 each
- * Mini-Missile Bay (1; center) — 30
- ** Main Body — 165

* Every item marked by a single asterisk is small and/or difficult to strike. An attacker must make a called shot to hit, even then he is -3 to strike. Destroying the tail fin makes the vehicle's flight wobbly (-10% on skill proficiency) and reduces the vehicle's speed by 10%. Reduce the vehicle's speed and altitude by 25% for each thruster that is destroyed. If all four thrusters are destroyed the vehicle is crippled and cannot fly.

** Depleting the M.D.C. of the main body completely destroys the vehicle.

Speed

Flying: The enhanced propulsion system enables the vehicle to hover in a stationary position or fly. Maximum flying speed is 100 mph (160 km), but cruising speed is usually around 45 mph (76 km) and considerably slower when prowling through enemy territory. The pod can hover a few feet above the ground or up to 600 feet (183 m) in the air.

Flying Range: Effectively unlimited.

Statistical Data

Height: 4 feet (1.2 m) from tail tip to the top of the windshield.

Width: 3 feet, 6 inches (1 m)

Length: 6 feet (1.8 m)

Weight: 800 lbs (360 kg)

Cargo: Four storage bays to hold additional equipment and supplies (the fifth bay has been converted into a mini-missile launcher).

Color: Dark grey, green, blue, black or camouflage.

Power System: Nuclear, average energy life is 10 years.

Black Market Cost: 800,000 credits. Poor availability.

XM-70 Special Features:

1. Pulse Laser Turret (1): The turret housing can rotate 360 degrees and the weapon barrel can be raised and lowered 45 degrees.

Primary Purpose: Defense

Mega-Damage: 2D6 M.D. per single blast or 6D6 per triple pulse (the pulse counts as one melee action).

Rate of Fire: Equal to the pilot's attacks/actions per melee.

Maximum Effective Range: 2000 feet (610 m)

Payload: Effectively unlimited.

2. Rear Laser Turret (1): Located in the rear of the pod, behind the seat of the driver is a small laser turret. The turret is especially effective against missile attack and to deter attacks from behind.

Primary Purpose: Anti-Missile

Secondary Purpose: Defense

Mega-Damage: 2D6 M.D. per blast

Rate of Fire: Usually set on automatic defense and firing five times per melee round.

Maximum Effective Range: 1200 feet (366 m)

Payload: Effectively unlimited.

3. Mini-Missile Launcher: The center storage bay has been converted into a small mini-missile launcher.

Primary Purpose: Anti-Aircraft

Secondary Purpose: Defense

Missile Type: Any mini-missile can be used, but standard issue is armor piercing (1D4 × 10 M.D.) or plasma (1D6 × 10). Fragmentation will be used for anti-personnel operations.

Mega-Damage: Varies with missile type.

Range: Usually about a mile.

Rate of Fire: One or a volley of two or three.

Payload: Six

4. Four Storage Bays: The pod has four storage bays. Each is large enough to hold a medium size backpack or equivalent amount of equipment. Items stored can include surveillance equipment, explosives, additional weapons, E-clips, disguises, tool kit, and so on.

XM-140 Infantry Support Weapon Platform

The XM-140 is an open top, flying troop assault and support vehicle used by the NGR military. It is dispatched to combat enemy ground and air troops, support NGR troops, assist in extractions, and back up the troops in any way possible. This versatile weapon platform sacrifices speed for firepower and armor.

Model Type: XM-140

Class: Military Weapon Platform/Troop Vehicle

Crew: Four: One pilot, one co-pilot (who also works communications), and two gunners. A fifth person to serve as an additional lookout and back-up crew member is common. The platform can also accommodate six passengers if absolutely necessary, but conditions are cramped.

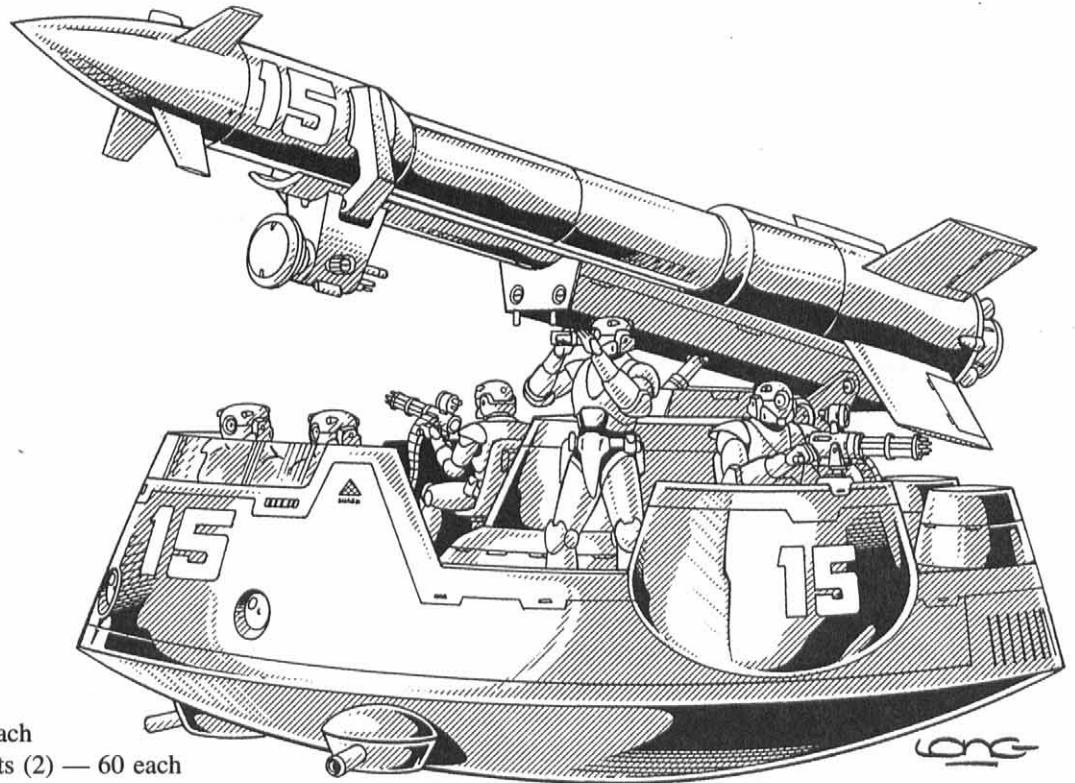

M.D.C. by Location:

- * Forward Headlights (2) — 5 each
- * Lower Forward Weapon Turrets (2) — 60 each
- Gunner Stations (2) — 110 each
- Rail Guns at Stations (2) — 50 each
- Long Range Missile (1) — 25
- Long Range Missile Launcher (1) — 120
- * Mini-Missile Launcher (1; center) — 60
- * Bottom Thruster (1; large) — 100
- * Rear Directional Jets (2; small, lower) — 20 each
- * Rear Force Field Generators (4) — 80 each
- Force Field — 320
- ** Main Body — 250

* Every item marked by a single asterisk is small and/or difficult to strike. An attacker must make a called shot to hit, even then he is -3 to strike. Destroying the large bottom thruster makes flight impossible — crash landing. Destroying the directional thrusters have little effect. Destroying one force field generator reduces the field by 60 points.

** Depleting the M.D.C. of the main body completely destroys the vehicle.

Speed

Flying: The propulsion system enables the vehicle to hover in a stationary position or fly. Maximum flying speed is 50 mph (80 km), but cruising speed is usually around 35 mph (56 km) and considerably slower when prowling through enemy territory. The platform can hover a few feet above the ground or up to 1000 feet (183 m) in the air.

Flying Range: Effectively unlimited.

Statistical Data

Shape: A somewhat oval disk shaped platform; slightly longer than it is wide.

Height: The main body is roughly 6 feet (1.8 m) tall. The long range missile launcher in its lowest position makes the platform 8 feet (2.4 m) tall.

Width: 18 feet (5.5 m)

Length: 20 feet (6 m)

Weight: Five tons

Cargo: Four small areas near the feet of the pilot, co-pilot and gunners.

Color: Typically light grey, dark grey, green, blue, black or camouflage.

Power System: Nuclear, average energy life is 10 years.

Black Market Cost: One million credits (plus missile cost). Rare.

XM-140 Special Features:

1. Long Range Missile Launcher (1): Toward the rear section of the platform is one large missile launcher and one long range missile. The launch housing can angle up or down in a 45 degree angle. However, the missile is typically a smart bomb (+5 to strike) that recognizes and pursues enemy targets, making trajectory adjustments in flight, so it can be launched in any position. Although the launcher is denoted as a long range missile firing mechanism, it can also fire medium range missiles. Typically operated by the pilot or co-pilot.

Primary Purpose: Anti-Aircraft/Anti-Armor

Secondary Purpose: Defense

Missile Type: Any long range (or medium range) missile can be used. Typically, a plasma, proton or nuclear smart bomb warhead (+5 to strike). Fragmentation will be used for anti-personnel operations.

Mega-Damage: Varies with missile type.

Range: Varies, 500 to 1800 miles (804 to 2893 km).

Rate of Fire: One

Payload: One

2. Concealed Mini-Missile Launcher: Underneath the long range missile launcher housing is a door that can flip open to reveal a battery of mini-missiles. Typically operated by the pilot or co-pilot.

Primary Purpose: Anti-Aircraft

Secondary Purpose: Defense

Missile Type: Any mini-missile can be used, but standard issue

is armor piercing (1D4 × 10 M.D.) or plasma (1D6 × 10). Fragmentation will be used for anti-personnel operations.

Mega-Damage: Varies with missile type.

Range: Usually about a mile.

Rate of Fire: One or a volley of two or three.

Payload: 12

3. Twin Pulse Laser Turrets (2): The two laser turrets are located in the lower, front section of the platform. Each can rotate 360 degrees and the weapon barrel can be raised and lowered 45 degrees. The turrets can be operated by either the pilot or co-pilot.

Primary Purpose: Assault

Secondary Purpose: Anti-Missile

Mega-Damage: 2D6 M.D. per single blast or 6D6 per triple pulse (the pulse counts as one melee action). Or both turrets can fire simultaneously at the same target, inflicting 1D6 × 10 + 6 M.D. (counts as one melee action).

Rate of Fire: Equal to the pilot's attacks/actions per melee.

Maximum Effective Range: 2000 feet (610 m)

Payload: Effectively unlimited.

4. Light Rail Guns (2; mini-gun style): On each side of the platform are two gunner stations. Each is manned by a gunner in cyclops body armor who operates a light rail gun. The guns can rotate 360 degrees and be angled up or down 180 degrees. DU-Rounds or U-Rounds can be used in place of the standard rounds described below.

Primary Purpose: Assault

Secondary Purpose: Defense

Weight: Gun: 60 lbs (27 kg)

Mega-Damage: A full damage burst fires 30 rounds and inflicts 6D6 M.D., a quick burst fires 15 rounds and inflicts 3D6 M.D., while a single round does one M.D. point

Rate of Fire: Equal to the character's hand to hand attacks per melee round (usually 3 to 6).

Maximum Effective Range: 4000 feet (1200 m)

Payload: 9000 rounds (300 full bursts). The weapon is belt fed from a massive ammo-drum in the hull of the platform. Reloading a drum will take an experienced field mechanic 20 minutes.

Special Sighting Feature: Each of the rail guns has its own laser targeting system as well as telescopic sight and nightvision scope. Telescopic and laser targeting range is 6000 feet (1828 m).

Bonus: +1 to strike.

5. Rechargeable Force Field Generators (4): Located in the back of the platform are four cone-shaped canisters. Each is a force field generator. They are designed to protect the vehicle, pilot and crew from enemy attack. Once depleted, it takes a full 24 hours for the field to recharge.

The big drawback of the force field is that none of the weapon systems can be engaged except for the forward laser turrets while the force field is up. The protective energy field must be dropped to fire missiles, rail guns or rifles. Consequently, the force field is typically engaged while travelling, retreating, or at strategic intervals during combat.

M.D.C. of the Force Field: 320 maximum; 80 per each of the four field generators (80 × 4). Subtract 80 points for each destroyed generator.

6. Four Storage Bays: The pod has four storage compartments; one near the pilot, co-pilot and the two gunners. Each is large enough to hold a medium size backpack or equivalent amount of equipment. Items stored can include surveillance equip-

ment, explosives, additional weapons, E-clips, binoculars, first-aid kit, and so on.

7. Sensors of Note: Long range communication, radar, and radar tracking same as the robot vehicles.

XM-170 Infantry Repair Barge

The XM-170 Repair Barge is an incredible, mobile robot and vehicle repair station that operates in the field of combat. It is heavily armored, has its own defensive weapons and a crew of 25 to 30.

Model Type: XM-170

Class: Military Mobile Mechanic's Station & Troop Carrier

Crew: 25: One pilot, one co-pilot, two communications officers, one gunner, plus 10 field mechanics and 10 assistants. An additional five mechanics, communication engineers or other soldiers may be added to the staff crew. There are 30 bunks for crew and mechanic staff. In an emergency, the repair barge can transport as many as 120 foot soldiers or 32 Jagers or 10 Black Knights on its deck.

M.D.C. by Location:

Top Forward Weapon Turrets (2) — 100 each

Lower Forward Weapon Turret (1) — 100

Rear Weapon Turrets (2) — 150 each

Repair Gantry (1) — 150

* Main Hatches (2) — 150 each

* Railing (6 ft/1.8 m section) — 10 each

* Bottom Thrusters (4; large) — 150 each

* Rear Directional Jets (4; small) — 30 each

* Forward Headlights (4) — 10 each

Forward Repair Station (1) — 600

Flatbed Barge Section — 1000

** Main Body (nose/pilot & crew section) — 600

* Every item marked by a single asterisk is small and/or difficult to strike. An attacker must make a called shot to hit even then he is -3 to strike. Destroying the large bottom thrusters makes flight impossible crash landing. Destroying the directional thrusters has little effect.

** Depleting the M.D.C. of the main body completely destroys the vehicle.

Speed

Flying: The propulsion system enables the vehicle to hover in a stationary position or fly. Maximum flying speed is 45 mph (72 km), but cruising speed is usually around 25 mph (40 km). The repair barge can hover a few feet above the ground or up to 100 feet (30.5 m) in the air.

Flying Range: Effectively unlimited.

Statistical Data

Shape: A long flatbed with a crew and repair section covering the front third of the vessel.

Height: 40 feet (12.2 m) tall from the bottom of the hover jets to the top of the repair station. The repair gantry adds another 25 feet (7.6 m) or a total height of 65 feet (19.8 m).

Width: 60 feet (18.3 m)

Length: 300 feet (91.5 m)

Weight: 114 tons

Cargo: The repair station and entire flatbed can be used to carry

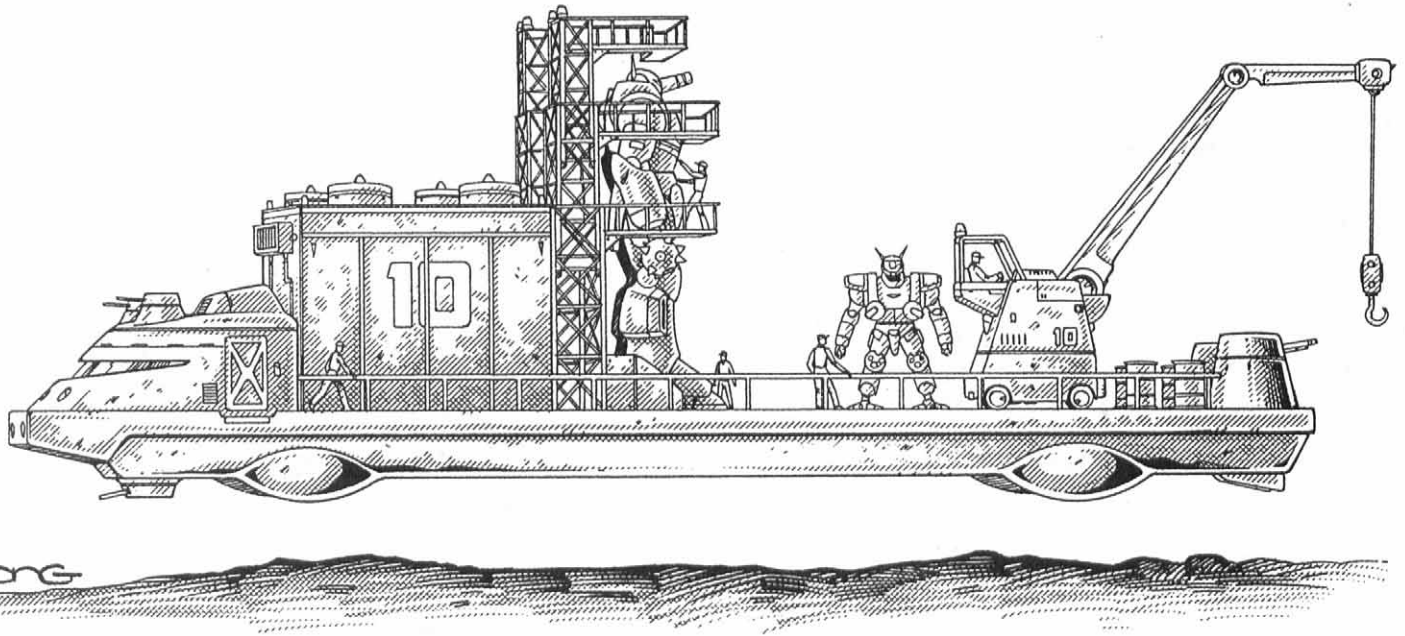

cargo, vehicles or troops if necessary.

Color: Typically light grey, dark grey, green, blue, black or camouflage.

Power System: Nuclear, average energy life is 20 years.

Black Market Cost: Not available.

XM-170 Special Features:

1. Twin Forward Laser Turrets (2): The two laser turrets on top of the forward section can rotate 360 degrees and the weapon barrel can be raised and lowered 45 degrees. The turrets can be operated by either the pilot or co-pilot.

Primary Purpose: Defense

Secondary Purpose: Assault

Mega-Damage: 5D6 M.D. per single blast or both turrets can fire simultaneously at the same target, inflicting 1D6 × 10 M.D. (counts as one melee action).

Rate of Fire: Equal to the pilot's attacks/actions per melee.

Maximum Effective Range: 2000 feet (610 m)

Payload: Effectively unlimited.

2. Lower Forward Laser Turret (1): The laser turret on the underbelly of the forward section is a long-range cannon. It can rotate 360 degrees and the weapon barrel can be raised and lowered 45 degrees. This turret can be operated by either the pilot or co-pilot.

Primary Purpose: Defense

Secondary Purpose: Assault

Mega-Damage: 5D6 per blast.

Rate of Fire: Equal to the pilot's attacks/actions per melee.

Maximum Effective Range: 4000 feet (1200 m)

Payload: Effectively unlimited.

3. Twin Rear Weapon Turrets (2): These are long-range ion cannons housed in armored turrets located in the tail of the barge. Each can rotate 360 degrees and the weapon barrel can be raised and lowered 45 degrees. The turrets are typically operated by the gunner. In addition to offering firepower, the turrets also help protect the barge deck and deck personnel by obstructing enemy fire from the rear.

Primary Purpose: Defense

Secondary Purpose: Anti-Missile & Aircraft/Gargoyle

Mega-Damage: 1D4 × 10 per single blast or both turrets can fire

simultaneously at the same target, inflicting 2D4 × 10 M.D. (counts as one melee action).

Rate of Fire: Equal to the gunner's attacks/actions per melee.

Maximum Effective Range: 3000 feet (914 m)

Payload: Effectively unlimited.

4. Concealed Mini-Missile Launcher: On top of the pilot's section is a concealed mini-missile launcher. It flips up and fires. The missiles are typically operated by the gunner or co-pilot.

Primary Purpose: Anti-Aircraft/Anti-Missile

Secondary Purpose: Defense

Missile Type: Any mini-missile can be used, but standard issue is armor piercing (1D4 × 10 M.D.) or plasma (1D6 × 10). Fragmentation will be used for anti-personnel operations.

Mega-Damage: Varies with missile type.

Range: Usually about a mile.

Rate of Fire: One or a volley of two or three.

Payload: 32

5. XM-171C Heavy Cargo Hauler & Crane (1): This giant vehicle can be seen on the deck of the XM-170 repair barge. It is a powerful crane and winch used in lifting and moving robots, vehicles, parts and cargo. The crane can rotate 360 degrees and be positioned up and down 180 degrees. The main body of the vehicle (200 M.D.C.) is 20 feet (6 m) tall and 16 feet (4.9 m) long. The crane can be elevated to a height of 60 feet (18.3 m) high and can lift and move up to 60 tons. The crane section has 150 M.D.C., the wheels 30 M.D.C. and the cable 50 M.D.C. Only one operator/pilot is required. All field mechanics are taught its operation (50% + 5% per level of experience).

6. Concealed Towing Cables (3): In the rear of the XM-170 are three large extendable, retractable winches with cables and hooks to tow large, disabled robots, tanks and vehicles. Each is capable of pulling 50 tons.

7. Robots & Vehicles: The standard XM-170 Repair Barge typically comes with two X-60 Flanker power armor suits used for cargo hauling and robot repairs, 10 T-11 Enhanced body armor suits and six XM-60 mechanic pods.

- 8. Additional Robots & Power Armor:** There is also a likelihood of there being present a handful (1D4) of robots or vehicles undergoing repairs. These bots can try to join in any fight to defend the barge.
- 9. The Repair Station & Storage Area:** The large, rectangular structure toward the front of the barge is a mobile garage 30 feet tall, 30 feet wide and 40 feet long (9×9×12 m). In addition to several mechanic work areas, there are hoists, lifts, welding equipment, computer diagnostic stations and just about everything else one would expect to find in a garage. There are also six XM-60 mechanic pods housed within. Behind the repair station is the 65 foot (19.8 m) tall, framework, repair gantry used for working on giant robots.
- 10. Sensors of Note:** All the same sensor and communication systems as robot vehicles, including long-range radio, radar, and radar tracking.

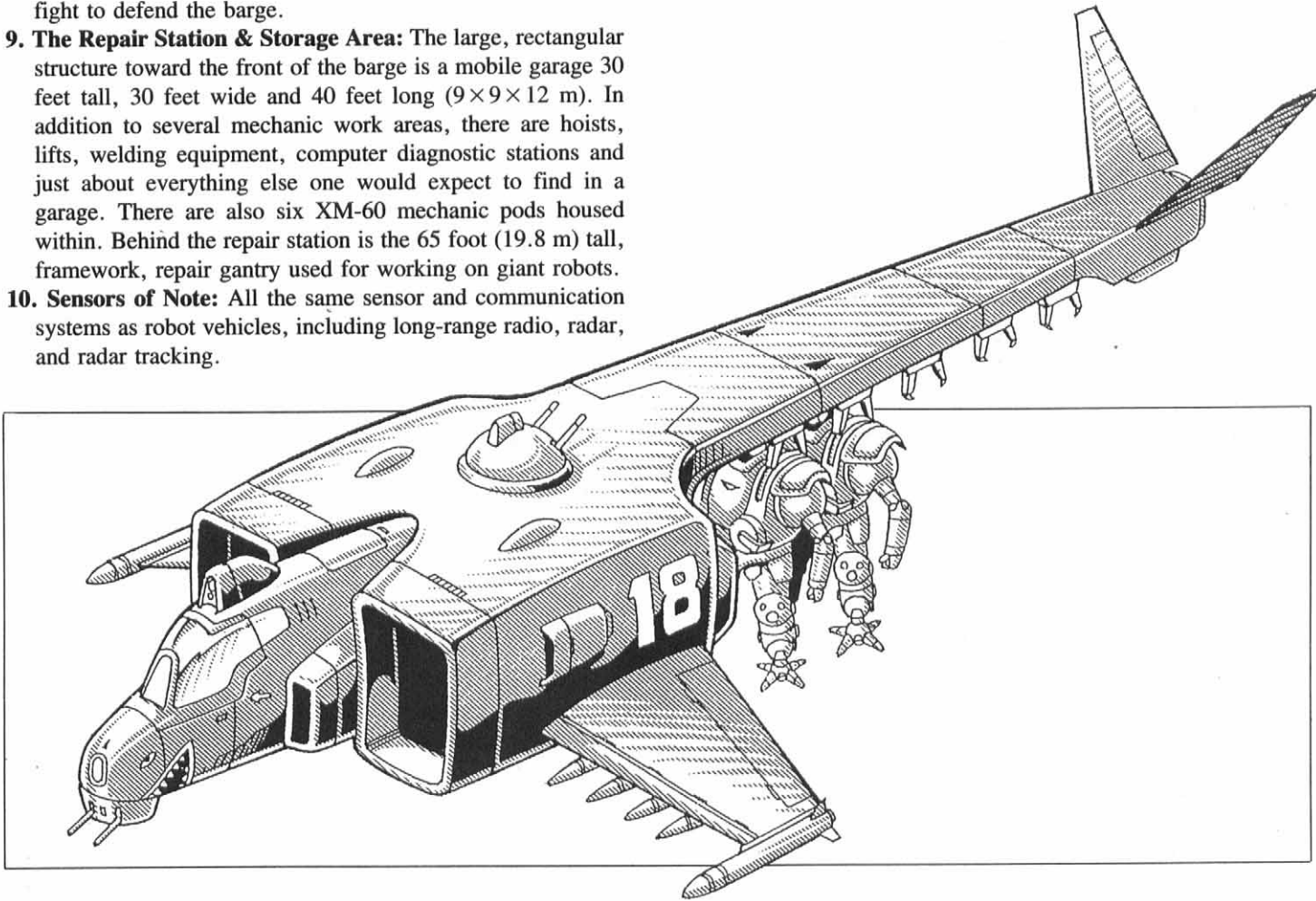

XM-180 “Dragonfly” Power Armor & Bot Drop Ship

The XM-180 “Dragonfly” gets its nickname from its somewhat dragonfly shape. It is a fast, well armed bot and power armor transport combat jet. Its defenses include a dual rail gun in the nose, laser turret in the center of its main body, and over a dozen missiles. The rear section of the jet has clamps that hold and release armored paratroopers.

The XM-180’s paratrooper payload is typically five Jagers, or five DV-40 combat bots, or four Super Jagers. Of course, other bots such as the Ulti-Max, Dyna-Max, Flanker, Predator or EIRs can be carried and parachute dropped instead of the Jagers or DV-40 bots. Alternately, ten (10) man-sized bots or power armor troops such as the Super Trooper, Glitter Boy, Terrain Hopper and DV-12, can be carried and dropped into enemy territory. **Note:** See the comic strip for the XM-180 and Jagers in action.

Model Type: XM-180

Class: Military Jet Fighter & Transport

Crew: Four: One pilot, one co-pilot, one communications officer, and a gunner. The cockpit area can also accommodate four passengers comfortably.

Power Armor or Bot Payload: Five Jager size units, four Super Jager sized units or 10 man-sized (8 feet/2.4 m or smaller).

M.D.C. by Location:

- * Nose Weapon Turret (1) — 45
- * Top Weapon Turret (1) — 60
- * Medium Range Missiles (2) — 25 each
- * Sensor Dome (1; top of cockpit) — 45
- * Carrying Clamps (10) — 10 each
- * Wings (2) — 100 each
- * Tail Fins (2) — 45 each
- Main Thrusters (2; large) — 190 each
- Secondary Thrusters (2; medium) — 60 each
- Tail Section — 200
- Reinforced Pilot’s Compartment — 100
- ** Main Body: Nose Section — 250

* Every item marked by a single asterisk is small and/or difficult to strike. An attacker must make a called shot to hit and even then he is -3 to strike.

Destroying one or both tail fins makes flight wobbly, reduces maximum speed by 25% and the piloting skill is -30% to make a successful maneuver. Destroying a wing causes the jet to spiral and crash — crew and passengers must eject and parachute to safety. Destroying the sensor dome knocks out long-range communication and long-range radar.

** Depleting the M.D.C. of the main body completely destroys the vehicle.

Speed

Flying: Mach 1.5 (roughly 1005 mph/1608 km) maximum, but cruising "drop" speed is usually a comparatively slow 300 mph (480 km).

Flying Range: Effectively unlimited.

Maximum Altitude: 50,000 feet (15,240 m).

Statistical Data

Height: 18 feet (5.5 m) tall.

Width/Wingspan: 35 feet (10.7 m)

Length: 65 feet (19.8 m)

Weight: 16 tons unloaded

Cargo: Bots and power armor troops. See description.

Color: Typically silver, light grey, dark grey, blue, or camouflage.

Power System: Nuclear, average energy life is 10 years.

Black Market Cost: One million credits (plus missile cost). Rare.

Weapon Systems

1. Medium Range Missile Launcher (2): Each wing has one medium range missile. Typically operated by the gunner.

Primary Purpose: Anti-Aircraft/Anti-Armor

Secondary Purpose: Defense

Missile Type: Any medium range missile can be used. Typically, a plasma, high explosive (heavy) or multi-warhead.

Mega-Damage: Varies with missile type.

Range: Varies, 40 to 80 miles (64 to 128 km).

Rate of Fire: One

Payload: Two; one on each wing tip.

2. Wing Mini-Missiles (16): Underneath the wings are two rows of four mini-missiles. The launching of mini-missiles is typically controlled by the gunner or co-pilot.

Primary Purpose: Anti-Aircraft/Gargoyle/Anti-Missile

Secondary Purpose: Defense

Missile Type: Any mini-missile can be used, but standard issue is armor piercing (1D4 × 10 M.D.) or plasma (1D6 × 10). Fragmentation will be used for anti-personnel operations.

Mega-Damage: Varies with missile type.

Range: Usually about a mile.

Rate of Fire: One at a time or a volley of two, three or four.

Payload: 16 total, eight on each wing.

3. Nose Gun (light rail gun; 1): The front of the nose has a double-barrel rail gun turret. The turret can rotate 360 degrees and the barrels can be angled up or down 45 degrees. This gun is typically controlled by the pilot.

Primary Purpose: Assault

Secondary Purpose: Defense

Mega-Damage: A full damage burst fires 30 rounds and inflicts 6D6 M.D.

Rate of Fire: Equal to the pilot's hand to hand attacks per melee round (usually 3 to 6).

Maximum Effective Range: 4000 feet (1200 m)

Payload: 6000 rounds (200 full bursts). The weapon is fed from a massive ammo-drum in the nose of the jet. Reloading a drum will take an experienced field mechanic 20 minutes.

Bonus: Bonus: +1 to strike.

4. Double-barrelled Laser Turret (1): A laser turret is located on the top of the XM-180 Dragonfly to fight aerial attackers and counter enemy missiles. It can rotate 360 degrees and the barrels can be raised and lowered in a 45 degree arc of fire. The laser turret is typically operated by the gunner.

Primary Purpose: Assault

Secondary Purpose: Anti-Missile

Mega-Damage: 3D6 M.D. per single blast or 6D6 per double blast.

Rate of Fire: Equal to the gunner's attacks/actions per melee round (typically 3 to 6).

Maximum Effective Range: 4000 feet (1200 m)

Payload: Effectively unlimited.

5. Anti-Missile Chaff Dispenser (1): Located in the tail end of the combat jet is a chaff dispenser. When tailed by missiles, a cloud of chaff and other obtrusive particles can be released to confuse or detonate the enemy's attack.

Primary Purpose: Anti-Missile

Mega-Damage: None, but roll percentile dice to determine the result.

01-50 Enemy missile or missile volley detonates in the chaff cloud — the threat is over.

51-75 Enemy missile or missile volley loses track of real target and veers away in the wrong direction (may lock onto another nearby aircraft).

76-00 No effect! Missiles still on target!!

Also note that the chaff cloud will temporarily blind gargoyles and other flying monsters who pass through the cloud. The victims suffer the following penalties: Reduce melee attacks/actions, combat bonuses and speed by half. Duration: 1D4 melee rounds (15 to 60 seconds). However, after that period the creature recovers and can renew his attack.

Payload: Six

6. Sensors of Note: Long-range communication, radar, and radar tracking same as robot vehicles.

XM-250 Medical Hover Station

The XM-250 is a giant, mobile field hospital. It has eight surgical stations, a laboratory with refrigeration units, x-ray machine, quarantine chamber, 12 hospital beds, 24 bunks (plus bunks for the crew to rest and sleep on in the field), four surgical teams, four field medics, four XM-50 Medic Pods and just about everything else you'd expect to find at a medical facility.

The vehicle is large and bulky, heavily armored and equipped with defensive weapons to use against the demonic enemy. Sadly, the enemy does not acknowledge the sanctity of a hospital or any rules of humanitarian conduct. They attack unarmed foes, medical personnel, the sick and the injured without hesitation. Thus, the surgical station must have armaments to protect itself from monstrous attackers. The XM-Medical Station never uses its weapons to instigate an attack — they are purely for self defense.

The XM-250 is typically escorted by four to six Dragonwings, or XM-270 Mosquito airships, XM-275 Lightning combat jets, or eight X-10A Predators, or any combination of them.

Model Type: XM-250

Class: Military Medical Hover Vehicle

Crew: Five: One pilot, one co-pilot, one communications officer, and two gunners.

The 28 medical personnel include eight surgeons, two cyber-docs, eight nurses, four orderlies/assistants, two chemists/laboratory techs, four field medics. 24 bed ridden patients and 24

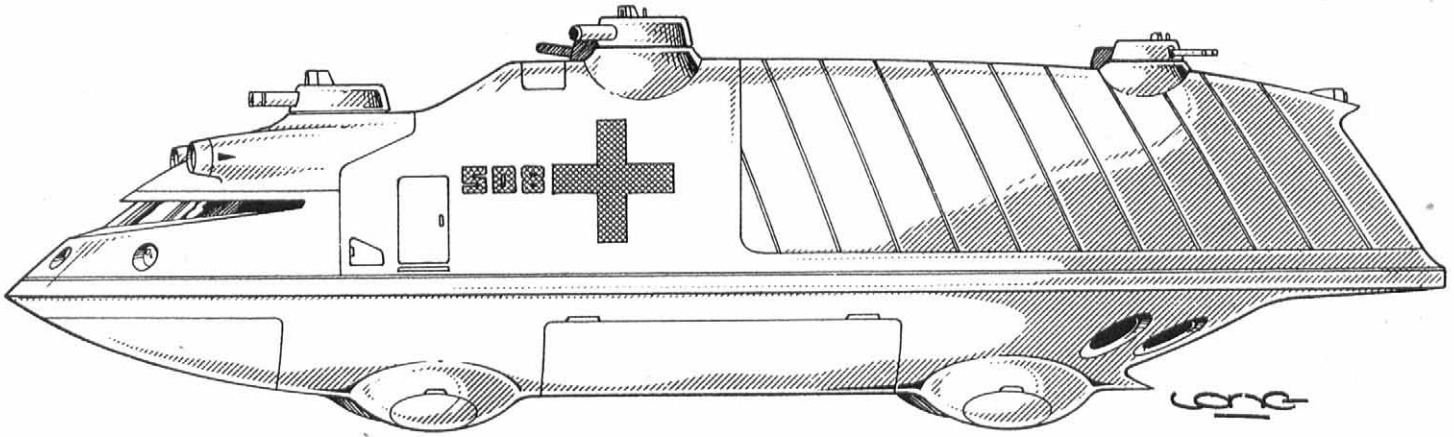

ambulatory patients can be accommodated comfortably. However, an additional 24 people can be squeezed in during an emergency.

M.D.C. by Location:

- * Rear Tail Lights (2) — 5 each
- * Forward Headlights (4) — 5 each
- * Forward Searchlights (2; large) — 10 each
- * Forward Weapon Turret (1; top) — 60
- * Middle Weapon Turrets (2) — 60 each
- * Rear Weapon Turrets (2) — 40 each
- * Rear Hatch (1; bay doors) — 180
- * Side hatches (2) — 100 each
- Belly Hatch (1) — 240
- Main Thrusters (4; large) — 150 each
- * Secondary Thrusters (4; rear) — 80 each
- Rear Half of the Vessel — 1000
- Reinforced Pilot's Compartment — 150
- ** Main Body: Nose Section — 700

* Every item marked by a single asterisk is small and/or difficult to strike. An attacker must make a called shot to hit and even then he is -3 to strike. Destroying half the hover jets reduces the vessel's speed by half. Destroy them all and the medical station is immobilized.

** Depleting the M.D.C. of the main body completely destroys the vehicle.

Speed

Flying: 140 mph (224 km) maximum, but cruising speed is usually around 50 mph (80 km).

Flying Range: Effectively unlimited.

Maximum Altitude: 2000 feet (610 m).

Statistical Data

Height: 25 feet (7.6 m) tall.

Width/Wingspan: 26 feet (7.9 m)

Length: 130 feet (39.6 m)

Weight: 129 tons fully loaded

Cargo: Medical supplies and personnel. See description.

Color: Typically white or light grey with a large red cross on the sides, top and belly.

Power System: Nuclear, average energy life is 20 years.

Black Market Cost: A similarly styled vessel would cost something in the neighborhood of 15 to 20 million credits (plus medical equipment and crew).

Weapon Systems

1. Forward Weapon Turret: Long-range Pulse Laser Cannon

(1): The single barrel turret is located on the top of the cockpit. It can rotate 360 degrees and the weapon barrel can be raised and lowered in a 45 degree arc of fire. The forward turret is typically operated by the co-pilot.

Primary Purpose: Defense

Secondary Purpose: Anti-Missile

Mega-Damage: 2D6 M.D. per single blast or 6D6 per triple pulse (the triple pulse counts as one melee action).

Rate of Fire: Equal to the pilot's attacks/actions per melee.

Maximum Effective Range: 4000 feet (1200 m)

Payload: Effectively unlimited.

2. Middle Weapon Turrets: Long-range Pulse Laser Cannons

(2): These two laser turrets are located on the top of the medical station near the midsection. They can rotate 360 degrees and the weapon barrels can be raised and lowered 45 degrees. These turrets are typically operated by the gunner.

Primary Purpose: Defense

Secondary Purpose: Anti-Missile

Mega-Damage: 2D6 M.D. per single blast or 6D6 per triple pulse (the pulse counts as one melee action). Or both turrets can fire simultaneously at the same target, inflicting $1D6 \times 10 + 6$ M.D. (counts as one melee action).

Rate of Fire: Equal to the gunner's attacks/actions per melee.

Maximum Effective Range: 4000 feet (1200 m)

Payload: Effectively unlimited.

3. Single Barrel Laser Turrets (2):

A pair of laser turrets are located on top of the medical station toward the rear. These are smaller and shorter range weapons designed mainly as an anti-missile system. As usual, the laser turrets can rotate 360 degrees and the barrels can be raised and lowered in a 45 degree arc of fire. The rear laser turrets are typically operated by the gunner or communications officer.

Primary Purpose: Defense

Secondary Purpose: Anti-Missile

Mega-Damage: 3D6 M.D. per single blast or 6D6 per simultaneous blast from both turrets firing at the same target.

Rate of Fire: Equal to the gunner's attacks/actions per melee round (typically 3 to 6).

Maximum Effective Range: 2000 feet (614 m)

Payload: Effectively unlimited.

4. Sensors of Note: Long-range communication, radar, and radar tracking same as the robot vehicles.

XM-270 "Mosquito" VTOL APC & Airship

The XM-270 "Mosquito" Airship is a 22 year old design that is more popular among fighter pilots today than ever! The Mosquito is fast, versatile, and powerful. The entire ship, including cockpit, is completely sheathed in armor. All displays and images are holographic projections and/or displayed on HUD systems. The rail gun turrets are rapid fire and excellent for close combat dogfights. The twin ion cannons are devastating, especially against enemies like the gargoyles, dragons and (other humanoid) opponents.

The "Mosquito's" Vertical Take-Off & Landing (VTOL) capabilities makes it ideal for troop insertions, extractions, and rescues. This has made it a favorite among commandos, intelligence officers and reconnaissance teams. As an Armored Personnel Carrier (APC), it can transport as many as 24 foot soldiers (12 in each of the side housings). It can also be used to transport much needed supplies to combat zones.

If the XM-270 has any drawbacks, it is its somewhat erratic range of speed. The vessel can hover in a stationary position and fly at a speed of one to 450 mph (up to 720 km). To travel faster, the Mosquito has a *turbo boost overdrive system*. When the overdrive is engaged, the powerful rear rocket snaps on and propels the airship at a speed of Mach 2 to Mach 2.5 (roughly 1340 to 1650 mph/2144 to 2655 km). The problem is the XM-270 cannot fly at speeds between 451 and 1340 mph! The airship simply rockets from low speed to high speed with nothing in between. Still, it is an excellent and versatile combat vehicle and a wonderful APC.

Model Type: XM-270

Class: Military VTOL Jet Fighter & Transport

Crew: Five: One pilot, one co-pilot, one communications officer, and two gunners.

APC Troop Payload: 24 to 36 total. The two side appendages that the ion cannons are mounted on are troop compartments that can accommodate as many as 12 man-sized troops/passengers comfortably (18 cramped). The low speed jet thrusters are also located at the rear of these compartments.

M.D.C. by Location:

- * Nose Laser (1) — 50
- * Side Rail Gun Turrets (2) — 110 each
- * Side Ion Cannons (2) — 200 each
- * Side Thrusters (2) — 150 each
- * VTOL Thrusters (5; underbelly) — 90 each
- Overdrive Rocket Thruster (1; rear) — 250
- Side Troop Compartments (2) — 400 each
- * Sensor Dome (1; top of cockpit) — 110
- * Landing Feet (3) — 90 each
- Reinforced Pilot's Compartment — 100
- ** Main Body — 900

* Every item marked by a single asterisk is small and/or difficult to strike. An attacker must make a called shot to hit and even then he is -3 to strike. Destroying the sensor dome knocks out long-range communication and long-range radar.

** Depleting the M.D.C. of the main body completely destroys the vehicle.

Speed

Flying Conventional (Low Speed): Hover stationary to a maximum speed of 450 mph (up to 720 km).

Flying Rocket Propelled (High Speed): When the turbo overdrive is engaged, the powerful rear rocket propels the airship at Mach 2 to Mach 2.5 (roughly 1340 to 1650 mph/2144 to 2655 km). The XM-270 cannot regulate flight at speeds between 451 and 1340 mph.

Flying Range: Effectively unlimited.

Maximum Altitude: 20,000 feet (6096 m) at low speed or 50,000 feet (15,240 m) at high speeds.

Statistical Data

Height: 20 feet (6 m) tall

Width: 36 feet (10.9 m)

Length: 75 feet (22.9 m)

Weight: 35 tons fully loaded.

Cargo: Troops, bots, power armor and supplies. See description.

Color: Typically silver, light grey, dark grey, blue, or camouflage.

Power System: Nuclear, average energy life is 20 years.

Black Market Cost: Black market knock-offs cost 42 million

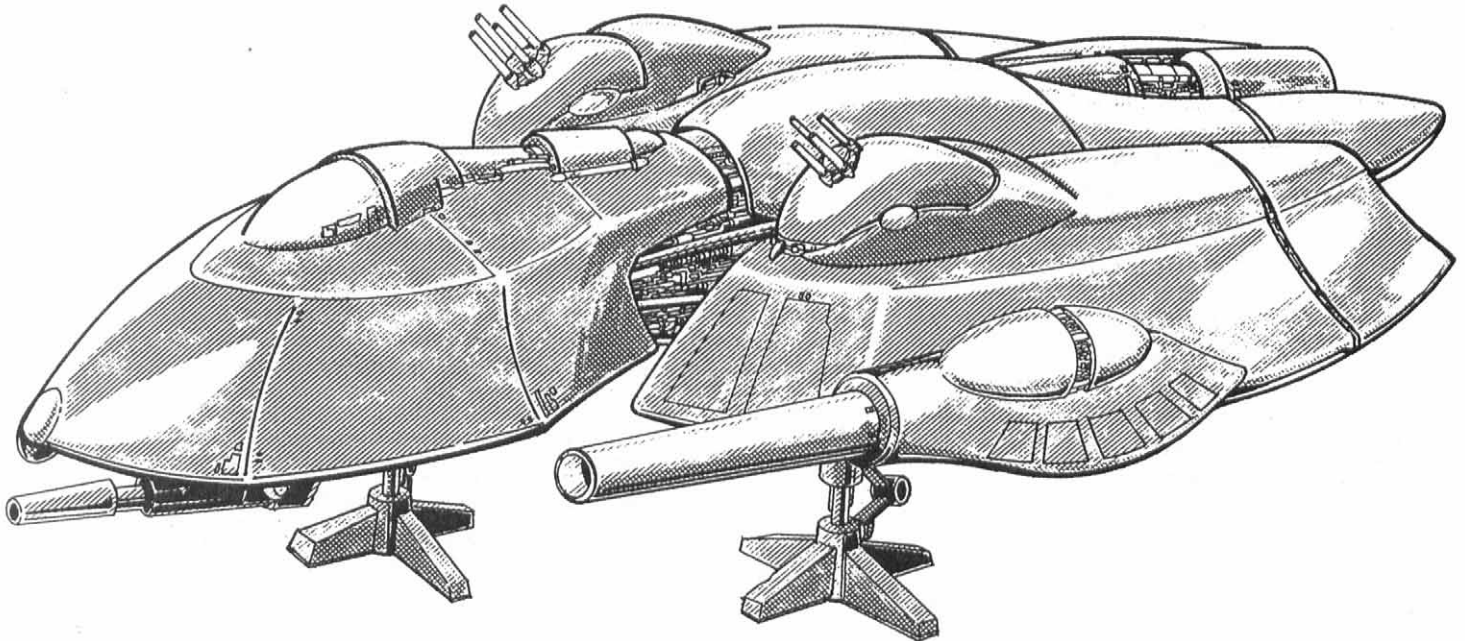

credits and do NOT have the heavy ion cannons (typically replaced by lasers or rail guns), otherwise all stats are unchanged.

Weapon Systems

1. Nose Laser (1): The forward laser is a heavy assault weapon controlled by the pilot or co-pilot. It can move side to side 180 degrees and up and down in a 45 degree arc of fire.

Primary Purpose: Anti-Aircraft/Gargoyle

Secondary Purpose: Defense

Mega-Damage: 5D6 M.D. per blast.

Rate of Fire: Equal to the operator's hand to hand attacks per melee round (usually 3 to 6).

Maximum Effective Range: 4000 feet (1200 m)

Payload: Effectively unlimited.

Bonus: +1 to strike.

2. Rail Gun Turrets (2): On each of the side troop compartments is a rail gun turret. Each can rotate and angle up or down 180 degrees. They are typically controlled by one of the gunners or by the communications officer.

Primary Purpose: Assault

Secondary Purpose: Defense

Weight: Gun: 60 lbs (27 kg)

Mega-Damage: A burst fires 30 rounds and inflicts 1D4 × 10 M.D.; single rounds cannot be fired. A synchronized attack from both turrets firing simultaneously at the same target inflicts 2D4 × 10 M.D.

Rate of Fire: Equal to the character's hand to hand attacks per melee round (usually 3 to 6) plus one!

Maximum Effective Range: 4000 feet (1200 m)

Payload: 9000 rounds (300 full bursts). The weapon is fed from a massive ammo-drum in the hull of the platform. Reloading a drum will take an experienced field mechanic 20 minutes.

3. High-Powered Ion Cannons (2): The side mounted ion cannons are located on the troop compartments. They are fixed forward but fire a devastating blast of destructive energy. They are typically controlled by the gunners or co-pilot.

Primary Purpose: Anti-Aircraft/Gargoyle

Secondary Purpose: Defense

Mega-Damage: 1D4 × 10 M.D. per single blast or 2D4 × 10 per simultaneous blasts from each at the same target.

Rate of Fire: Equal to the gunner's hand to hand attacks per melee round (usually 3 to 6).

Maximum Effective Range: 3000 feet (914 m)

Payload: Effectively unlimited.

Bonus: +1 to strike.

4. Mini-Missile Side Launchers (10): On the side of each of the ion cannons are five compartments that conceal mini-missiles. Each compartment contains two missiles. Mini-missiles are typically launched by the gunners or the co-pilot.

Primary Purpose: Anti-Aircraft/Gargoyle/Anti-Missile

Secondary Purpose: Defense

Missile Type: Any mini-missile can be used, but standard issue is armor piercing (1D4 × 10 M.D.), or plasma (1D6 × 10). Fragmentation will be used for anti-personnel operations.

Mega-Damage: Varies with missile type.

Range: Usually about a mile.

Rate of Fire: One at a time or a volley of two, three or four.

Payload: 20 total, ten in each side (two per compartment).

5. Anti-Missile Chaff Dispenser (1): Located in the very tail end of the aircraft is a chaff dispenser. When tailed by missiles, a cloud of chaff and other obtrusive particles can be

released to confuse or detonate the enemy's attack. This defensive feature is usually controlled by the co-pilot or pilot.

Primary Purpose: Anti-Missile

Mega-Damage: None, but roll percentile dice to determine the result.

01-50 Enemy missile or missile volley detonates in the chaff cloud — the threat is over.

51-75 Enemy missile or missile volley loses track of real target and veers away in the wrong direction (may lock onto another nearby aircraft).

76-00 No effect! Missiles still on target!!

Also note that the chaff cloud will temporarily blind gargoyles and other flying monsters who pass through it. The victims suffer the following penalties: Reduce melee attacks/actions, combat bonuses and speed by half. Duration: 1D4 melee rounds (15 to 60 seconds). However, after that period the creature recovers and can renew his attack.

Payload: Four

6. Sensors of Note: Long-range communication, radar, and radar tracking same as the robot vehicles.

XM-275 "Lightning" VTOL Combat Jet

For all intents and purposes, the XM-275 "Lightning" is Triax's high-tech replacement of the 20th Century helicopter. It is a versatile combat jet that is fast, extremely maneuverable and capable of Vertical Take-Off and Landing (VTOL). It is used for light air and ground support, rescue, troop insertion, extraction and transport (troop and light cargo).

It gets the nickname of "Lightning" because of its speed, ability to make sharply angled turns at virtually any speed, and from one of its weapon systems, the TX-275 Arc Blaster.

Model Type: XM-275

Class: Military VTOL Jet Fighter & Transport

Crew: Four: One pilot, one co-pilot, one communications officer, and a gunner.

APC Troop Payload: The jet can carry as many as 12 man-sized troops/passengers comfortably (16 cramped).

M.D.C. by Location:

* Nose Laser (1) — 60

* Lightning Arc Charge Blasters (2) — 75 each

* Wings (2) — 150 each

* Secondary Wing Jets (2; one per wing) — 100 each

Wing Main Jet Thrusters (2; large) — 110 each

Wing VTOL Thrusters (2; large) — 100 each

*Tail Section (1; includes rear VTOL) — 150

* Retractable Landing Gear (3) — 50 each

Reinforced Pilot's Compartment — 75

** Main Body — 350

* Every item marked by a single asterisk is small and/or difficult to strike. An attacker must make a called shot to hit and even then he is -3 to strike.

Destroying the tail section makes flight wobbly, reduces maximum speed by 20% and the piloting skill is -20% to make a successful maneuver. Destroying a wing causes the jet to spiral and crash — the crew and passengers must eject

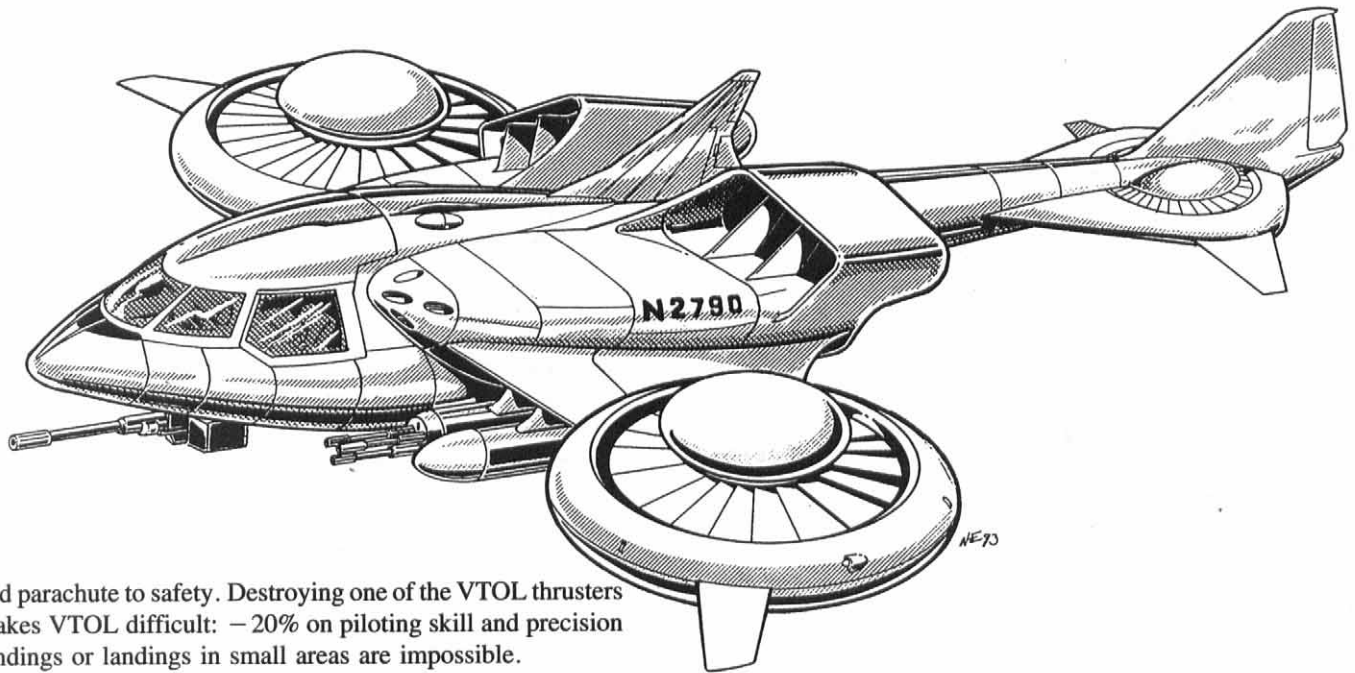

and parachute to safety. Destroying one of the VTOL thrusters makes VTOL difficult: -20% on piloting skill and precision landings or landings in small areas are impossible.

** Depleting the M.D.C. of the main body completely destroys the vehicle.

Speed

Flying: Hover in a stationary position, vertical movement and a maximum speed of Mach 2 (roughly 1340 mph/2144 km).

Maximum Altitude: 50,000 feet (15,240 m).

Flying Range: Effectively unlimited.

Statistical Data

Height: 16 feet (4.8 m) tall

Width: 40 feet (12.2 m)

Length: 65 feet (19.8 m)

Weight: 14 tons fully loaded.

Cargo: Troops, bots, power armor and supplies. See description.

Color: Typically silver, light grey, dark grey, blue, or camouflage.

Power System: Nuclear, average energy life is 10 years.

Black Market Cost: Black market knock-offs cost 40 million credits and do NOT have the "Lightning" Arc Charge Blaster and seldom have a speed greater than Mach 1.5, otherwise all stats are unchanged.

Weapon Systems

1. Nose Laser (1): The forward laser is a heavy assault weapon controlled by the pilot or co-pilot. It can move side to side 180 degrees and up and down in a 45 degree arc of fire.

Primary Purpose: Anti-Aircraft/Gargoyle

Secondary Purpose: Defense

Mega-Damage: 5D6 M.D. per blast.

Rate of Fire: Equal to the gunner's hand to hand attacks per melee round (usually 3 to 6).

Maximum Effective Range: 4000 feet (1200 m)

Payload: Effectively unlimited.

Bonus: +1 to strike.

2. TX-275 "Lightning" Arc Charge Blaster (2): Under each wing, near the fuselage, is the infamous arc charge blaster. This unique weapon fires a powerful electrical energy bolt that not only inflicts mega-damage but can cripple enemy aircraft. The arc charge guns are typically controlled by the co-pilot or gunner.

Primary Purpose: Anti-Aircraft/Gargoyle

Secondary Purpose: Defense

Mega-Damage: 6D6 M.D. per single blast (usually fired as a single blast) plus the charge zaps the electrical system of the enemy aircraft, bots and power armor with one of the following results (roll percentile dice).

01-15 Lucked out! No additional problems or side-effects.

16-30 The instrument panel of the enemy vessel momentarily blinks out and sparks fly. It snaps back on-line 1D4 seconds later but the crew loses the initiative (if they had it) and one melee attack. This may give their target the opportunity to escape or strike again before they have a chance to respond.

31-45 All weapon systems are temporarily out and there are minor electrical fires! One comes back on-line in 1D4 melee rounds (15 to 60 seconds)! Return to base is recommended.

46-60 All systems are temporarily out and there are minor electrical fires! All come back on-line in 1D4 melee rounds (15 to 60 seconds), the enemy aircraft is completely defenseless during that period and is -30% on the piloting skill. Evasive action is recommended.

61-75 Communications, radar and targeting are fried but weapon systems okay. Must rely on visual targeting and combat strikes. Penalty: -3 to strike and no initiative.

76-90 The instrument panel is fried! No radar, targeting, communications or instrument readings of any kind and one of the weapon systems will not respond. The pilot must fly strictly on sight. Piloting skill penalties: -25% at one-third of the maximum speed, -50% at half max. speed, and -75% at full speed. No initiative to strike, -3 to dodge, -3 to strike and the crew loses one melee action per melee round.

91-00 All systems locked! No instruments, radar, communications, or weapons. The aircraft, bot or armor will not respond and is out of control!! It will crash within 2D4 minutes. Crew must eject and parachute to safety.

Against gargoyles and other living creatures, the blast causes them to lose one melee action/attack and initiative for that melee round. Some of the supernatural beings and creatures of magic suffer double damage from electricity.

Rate of Fire: A maximum of four blasts per melee (two blasts per gun).

Maximum Effective Range: 2000 feet (610 m)

Payload: Effectively unlimited.

Bonus: +1 to strike.

Note: Using the lightning blast is tricky. The pilot of the XM-275 must be careful to fire and veer out of the way or slow down to Mach One or be in danger of catching part of the blast. Consequently, the pilot must roll under his piloting skill each time the weapon is fired to see if he successfully avoids it. If struck, damage, all penalties and penalty durations are half (only catches part of the charge).

3. Anti-Missile Chaff Dispenser (1): Located in the very tail end of the aircraft is a chaff dispenser. When tailed by missiles, a cloud of chaff and other obtrusive particles can be released to confuse or detonate the enemy's attack.

Primary Purpose: Anti-Missile

Mega-Damage: None, but roll percentile dice to determine the result.

01-50 Enemy missile or missile volley detonates in the chaff cloud — the threat is over.

51-75 Enemy missile or missile volley loses track of real target and veers away in the wrong direction (may lock onto another nearby aircraft).

76-00 No effect! Missiles still on target!!

Also note that the chaff cloud will temporarily blind gargoyles and other flying monsters who pass through the cloud. The victims suffer the following penalties: Reduce melee attacks/actions, combat bonuses and speed by half. Duration: 1D4 melee rounds (15 to 60 seconds). However, after that period the creature recovers and can renew his attack.

Payload: Four

4. Sensors of Note: Long-range communication, radar, and radar tracking same as the robot vehicles.

XM-280 Fighter Jet

The XM-280 is a traditional supersonic fighter and bomber. It can attain high altitudes and a speed of Mach 3. It is most often used against enemy strongholds and armored troops beyond the borders of the New German Republic.

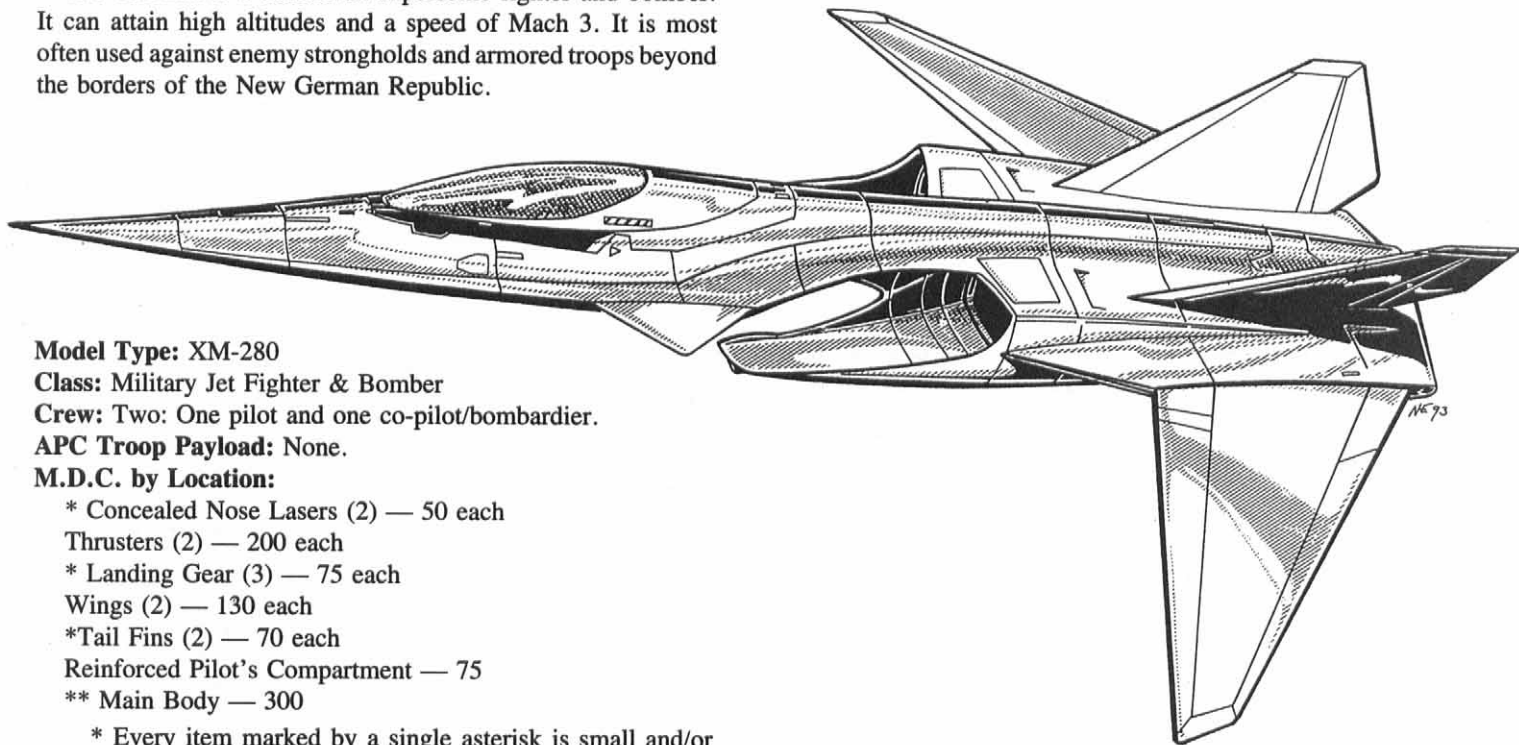

Model Type: XM-280

Class: Military Jet Fighter & Bomber

Crew: Two: One pilot and one co-pilot/bombardier.

APC Troop Payload: None.

M.D.C. by Location:

* Concealed Nose Lasers (2) — 50 each

Thrusters (2) — 200 each

* Landing Gear (3) — 75 each

Wings (2) — 130 each

*Tail Fins (2) — 70 each

Reinforced Pilot's Compartment — 75

** Main Body — 300

* Every item marked by a single asterisk is small and/or difficult to strike. An attacker must make a called shot to hit and even then he is -3 to strike.

Destroying one or both tail fins makes flight wobbly, reduces maximum speed by 25% and the piloting skill is -25% to make a successful maneuver. Destroying a wing causes the jet to spiral and crash — the crew must eject and parachute to safety.

** Depleting the M.D.C. of the main body completely destroys the vehicle.

Speed

Flying: A maximum speed of Mach 3 (roughly 2010 mph/3216 km). The XM-280 does not have the ability to hover or VTOL.

Flying Range: Effectively unlimited.

Maximum Altitude: 60,000 feet (18,288 m)

Statistical Data

Height: 15 feet (4.6 m) tall

Width: 40 feet (12.2 m)

Length: 70 feet (21.3 m)

Weight: 30 tons fully loaded.

Color: Typically silver, light grey, dark grey, blue, or camouflage.

Power System: Nuclear, average energy life is 20 years.

Black Market Cost: Not available.

Weapon Systems

1. Nose Lasers (2): The nose section of the jet has a pair of fixed forward, concealed, medium power lasers. They are controlled by the pilot.

Primary Purpose: Anti-Aircraft/Gargoyle

Secondary Purpose: Defense

Mega-Damage: 4D6 M.D. per single blast or 1D4 × 10 + 6 per double blast.

Rate of Fire: Equal to the pilot's hand to hand attacks per melee round (usually 3 to 6).

Maximum Effective Range: 2000 feet (610 m)

Payload: Effectively unlimited.

2. Bomb Payload (16): The XM-280 has a bomb bay that contains 16 bombs which can be dropped on enemy ground targets. Bombs are usually used on enemy installations, large encampments, storage depots, robots, armored vehicles and similar stationary or slow moving targets. Bombs are released by the co-pilot or pilot.

Primary Purpose: Anti-Aircraft/Gargoyle/Anti-Missile

Secondary Purpose: Defense

Bomb Type & Mega-Damage: Any of the following: High explosive: 3D4 × 10 M.D. per bomb. Plasma: 3D6 × 10 per bomb, plus a 90% likelihood of causing fires that spread to other combustible materials. Nuclear: 4D6 × 10 per bomb.

Area Affect: Typically the entire blast radius from a four bomb volley is 300 feet (91.5 m).

Range: Dropped from a as low as 1000 feet (+1 to strike) or as high as 20,000 feet (-2 to strike).

Rate of Fire: A volley of four, eight or 16 at a time.

Payload: 16 total.

3. Wing Mini-Missiles (8): Four mini-missiles can be attached to each wing. Mini-missiles are typically launched by the co-pilot.

Primary Purpose: Anti-Aircraft/Gargoyle/Anti-Missile

Secondary Purpose: Defense

Missile Type: Any mini-missile can be used, but standard issue is armor piercing (1D4 × 10 M.D.) or plasma (1D6 × 10). Fragmentation will be used for anti-personnel operations.

Mega-Damage: Varies with missile type.

Range: Usually about a mile.

Rate of Fire: One at a time or in volleys of two, three or four.

Payload: 8 total; four on each wing.

4. Anti-Missile Chaff Dispenser (1): Located in the very tail end of the aircraft is a chaff dispenser. When tailed by missiles, a cloud of chaff and other obtrusive particles can be released to confuse or detonate the enemy's attack. This defensive feature is usually controlled by the co-pilot or pilot.

Primary Purpose: Anti-Missile

Mega-Damage: None, see the description under the XM-270 or XM-275.

Payload: Four

5. Sensors of Note: Long-range communication, radar, and radar tracking same as the robot vehicles.

XM-288 Supersonic Transport

The XM-288 is a supersonic, sub-orbital transport jet. It stays in a low sub-orbital altitude because to go higher into orbit means getting blasted by Pre-Rifts weapon satellites in orbit around the planet (or possibly getting attacked or intercepted by the forces from the moon colony). The XM-288 Supersonic Transport is the vessel used to transport other vehicles, bots, power armor, weapons, supplies and raw materials from the NGR to the Coalition States and vice versa. The extreme altitude makes travel reasonably safe from would-be monster attackers and even most combat jets. Dimensional anomalies from the ley lines and rifts are also less common at these heights. The giant transport can cross the Atlantic Ocean and reach Chi-Town in less than three hours.

Model Type: XM-288

Class: Military supersonic transport

Crew: Ten: Pilot, co-pilot, communications officer, three gunners, and four cargo maintenance laborers.

M.D.C. by Location:

* Pulse Laser Turrets (2) — 100 each

Thrusters (4) — 500 each

* Landing Gear (3) — 75 each

Forward Cargo Bay Door/Hatch (1) — 500 each

*Tail Section — 800 each

Reinforced Pilot's Compartment — 175

** Main Body — 200

* Every item marked by a single asterisk is small and/or difficult to strike. An attacker must make a called shot to hit and even then he is -3 to strike.

Destroying one or both tail fins makes flight wobbly, reduces maximum speed by 25% and the piloting skill is -25% to make a successful maneuver. Destroying a wing causes the jet to spiral and crash — the crew must eject and parachute to safety.

** Depleting the M.D.C. of the main body completely destroys the vehicle.

Speed

Flying: A maximum speed of Mach 4.5 (roughly 3015 mph/4824 km). The XM-288 does not have the ability to hover or VTOL.

Flying Range: Effectively unlimited.

Maximum Altitude: 100,000 feet (30,500 m)

Note: Half of the aircraft is devoted to engines and thrusters.

Statistical Data

Height: Overall from belly to the top of the tail fin: 120 feet (36.6 m). Body only: 80 feet (24.4 m).

Width/Wingspan: 150 feet (45.7 m)

Length: 500 feet (152.4 m)

Weight: 1000 tons unloaded.

Cargo Areas: Cargo level one is 20 feet (6 m) tall, 80 feet (24.4 m) wide, and 150 feet (45.7 m) long, providing (12,000 square feet) 240,000 cubic feet of space. Cargo level two is 30 feet (9 m) tall, 80 feet (24.4 m) wide, and 250 feet (76.2 m) long, providing (20,000 square feet) 600,000 cubic feet of space.

Maximum cargo weight: 1000 tons (two million pounds).

Color: Typically silver, grey or blue.

Power System: Nuclear, average energy life is 20 years.

Black Market Cost: Absolutely not available! Even the NGR only has six of these aircraft!

Weapon Systems

- 1. Medium Range Missile Launchers (2):** Two concealed missile launchers are housed in the top of the aircraft in front of the weapon turret. The missiles are typically smart bombs (+5 to strike) that recognize and pursue enemy targets, making trajectory adjustments in flight.

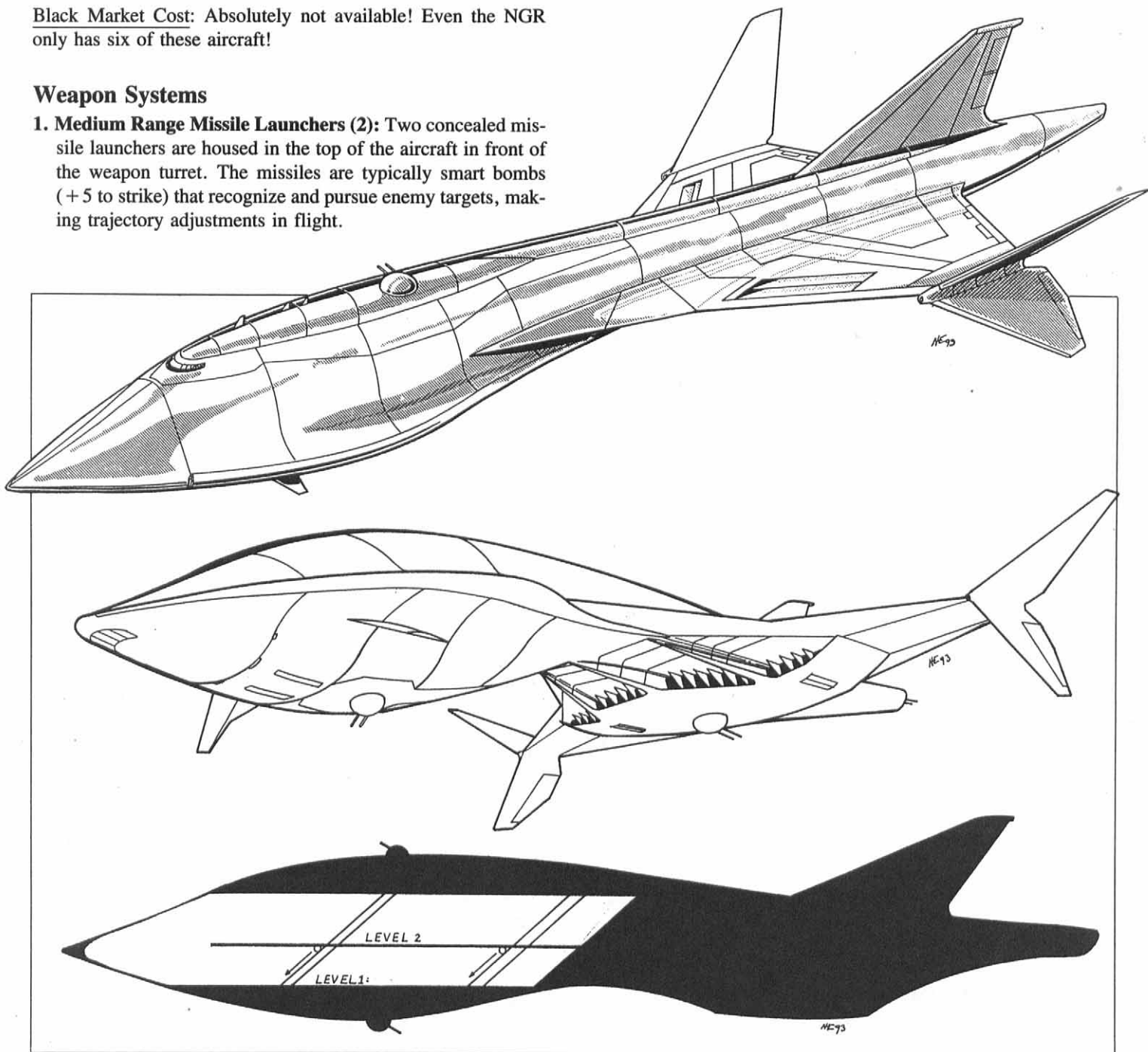

Primary Purpose: Defense/Anti-Aircraft/Anti-Missile

Missile Type & Mega-Damage: Any medium range missile can be used, typically, a plasma (2D6 × 10 M.D.) or multi-warhead (2D4 × 10 M.D.) — smart bombs (+5 to strike).

Range: Varies, typically 40 to 80 miles (64 to 128 km).

Rate of Fire: One or two at a time

Payload: 12

- 2. Pulse Laser Turrets (3):** One turret is located on the top toward the front, one is directly below it on the belly and another is on the belly toward the rear. Each can rotate 360 degrees and the weapon barrel can be raised and lowered 45 degrees. The turrets can be operated by either the pilot or co-pilot.

Primary Purpose: Defense/Anti-Missile

Mega-Damage: 2D6 M.D. per single blast or 6D6 per triple pulse (the pulse counts as one melee action. The two bottom

turrets can fire simultaneously at the same target, inflicting 1D6 × 10 + 6 M.D. (counts as one melee action).

Rate of Fire: Equal to the gunner's attacks/actions per melee.

Maximum Effective Range: 2000 feet (610 m)

Payload: Effectively unlimited.

- 3. Anti-Missile Chaff Dispenser (1):** Located in the very tail end of the aircraft is a chaff dispenser. When tailed by missiles, a cloud of chaff and other obtrusive particles can be released to confuse or detonate the enemy's attack. This defensive feature is usually controlled by the co-pilot or pilot.

Primary Purpose: Anti-Missile

Mega-Damage: None, see the description under the XM-270 or XM-275.

Payload: 12

- 4. Sensors of Note:** Long-range communication, radar, and radar tracking same as the robot vehicles.

XM-300 "Terror"

Mini-Tank

The "Terror" tank gets its nickname from the fact that it is so small yet bristling with weapons. This combined with its speed makes it a "terror" on the field of combat. The tank is a two to three man armored vehicle used for assaults, defense, and reconnaissance. The mini-tank operates best in urban, grass-land, and light forest environments. However, it functions admirably in all wilderness environments except mountains and extremely rocky terrains. The "Terror" mini-tank is even amphibious, able to cross rivers and lakes like a boat (but at a slow speed).

Model Type: XM-300

Class: Military Tank

Crew: Two: One pilot and a gunner. One additional gunner, communications officer, or passenger can be accommodated.

M.D.C. by Location:

- * Main Gun: Ion Cannon (1) — 100
- * Mini-Missile Launcher (1; rear) — 100
- * Forward Rail Gun Turrets (2; Front) — 50 each
- * Laser Gun (1; manned) — 30
- * Flamethrower Turrets (2; rear) — 25 each
- * Forward Headlights (2) — 5 each
- * Searchlights (2; front, top sides) — 10 each
- * Main Sensor (1; on top of ion cannons) — 20
- * Secondary Sensor (1; rear) — 20
- * Top Access Hatch (1) — 50
- * Main Access Hatch (1; main body) — 90
- * Hardened Wheels (10) — 25 each
- * Rear Aqua-Thrusters (2) — 25 each
- Reinforced Pilot's Compartment — 50
- ** Main Body — 300

* Every item marked by a single asterisk is small and/or difficult to strike. An attacker must make a called shot to hit and even then, he is -3 to strike. Destroying both sensor units means the pilot must rely on his own vision; no radar, targeting, etc.

** Depleting the M.D.C. of the main body completely destroys the vehicle.

Speed

Land: 95 mph (152 km)

Water: 10 mph (16 km)

Air: Flight is not possible.

Statistical Data

Height: 8 feet (2.4 m)

Width: 6 feet (1.8 m)

Length: 14 feet (4.2 m)

Weight: 3.5 tons fully loaded.

Cargo: A small area inside that is large enough to stow three backpacks, canteens and rifles.

Color: Typically light grey, dark grey, blue, green or camouflage.

Power System: Nuclear, average energy life is 20 years.

Black Market Cost: Black market knock-offs cost 40 million credits and may not have the same weapon systems.

Weapon Systems

1. High-Powered Ion Cannon (1): The main gun is an ion cannon built into a large turret. The entire turret, which in-

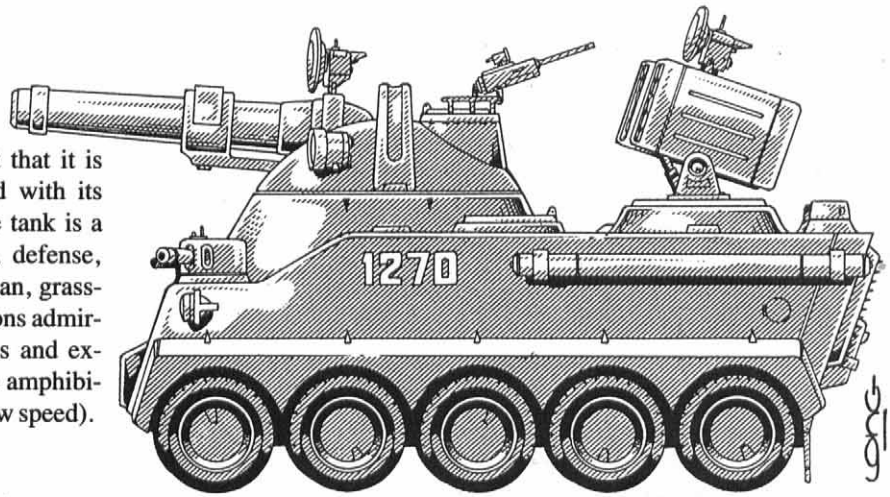

cludes a sensor disk and man operated laser gun, can turn 360 degrees. The cannon itself can be raised in a 45 degree arc of fire. The main gun is typically controlled by the gunner.

Primary Purpose: Assault/Anti-Armor/Anti-Monster

Secondary Purpose: Defense

Mega-Damage: 1D4 × 10 M.D. per blast.

Rate of Fire: Equal to the gunner's hand to hand attacks per melee round (usually 3 to 6).

Maximum Effective Range: 3000 feet (914 m)

Payload: Effectively unlimited.

Bonus: +1 to strike.

2. Laser Gun (1): Mounted on the top of the turret is a laser gun. To operate, one of the crew members must open the access hatch below the gun and manually fire it like a machine-gun. It can move side to side 180 degrees and up and down in a 90 degree arc of fire.

Primary Purpose: Anti-Personnel

Secondary Purpose: Anti-Missile

Mega-Damage: 4D6 M.D. per blast.

Rate of Fire: Equal to the operator's hand to hand attacks per melee round (usually 3 to 6).

Maximum Effective Range: 2000 feet (610 m)

Payload: Effectively unlimited.

3. Forward Rail Gun Turrets (2): Two rail gun turrets are located at the front of the mini-tank. Each can rotate and angle up or down 45 degrees. They are typically controlled by the gunner or pilot.

Primary Purpose: Anti-personnel

Secondary Purpose: Defense

Mega-Damage: A burst fires 30 rounds and inflicts 1D4 × 10 M.D.; single rounds cannot be fired. A synchronized attack from both turrets firing simultaneously at the same target inflicts 2D4 × 10 M.D.

Rate of Fire: Equal to the character's hand to hand attacks per melee round (usually 3 to 6) plus one!

Maximum Effective Range: 4000 feet (1200 m)

Payload: 12,000 rounds (400 bursts) total; 6000 rounds (200 bursts) per each turret. The weapon is fed from a massive ammunition drum in the hull of the platform. Reloading a drum will take an experienced field mechanic 10 minutes.

4. Dual Mini-Missile Launcher (1): In the rear of the vehicle is a dual mini-missile launcher. The launcher can rotate 360 degrees, with a 45 degree arc of fire. Mini-missiles are typically launched by the gunner or the pilot.

Primary Purpose: Anti-Aircraft/Gargoyle/Anti-Missile

Secondary Purpose: Assault

Missile Type: Any mini-missile can be used, but standard issue is armor piercing (1D4 × 10 M.D.) or plasma (1D6 × 10). Fragmentation will be used for anti-personnel operations.

Mega-Damage: Varies with missile type.

Range: Usually about a mile.

Rate of Fire: One at a time or a volley of two, three or four.

Payload: 20 total, ten in each side.

5. Flamethrowers (2): Two small flamethrower turrets, capable of 180 degree rotation, are located on the rear of the vehicle.

Primary Purpose: Anti-Personnel

Secondary Purpose: Vegetation removal

Mega-Damage: 1D4 M.D. per single blast or 2D4 per simultaneous double blast of napalm-like fire. Plus there is a 01-90% likelihood of setting all combustible material, including fuel, wood, dry grass, clothes and hair, on fire. The fire does an additional 1D4 M.D. per melee round and burns for a minimum of 2D4 minutes.

Maximum Effective Range: 200 feet (61 m)

Rate of Fire: Equal to number of combined hand to hand attacks (usually 4-8).

Payload: A total of 24 blasts, 12 from each turret.

6. Sensors of Note: Long-range communication, radar, and radar tracking same as the robot vehicles.

7. Special Features: 1) High impact, puncture proof tires. The vehicle can travel at full speed even if four of its tires have been destroyed. Reduce speed by 40% if six tires have been destroyed and by 90% if seven or more have been destroyed.

2) The entire main turret can rotate 360 degrees.

3) The ion cannon cleaning rod is attached to the side of the vehicle. It is used to clean dirt and particles from the main gun.

XM-330 "Phantom"

Hover Tank

The XM-330 tank is called the "Phantom" because it moves quickly and silently on a cushion of air. All that can be heard is the low hum of the engines and gentle whoosh as it passes. This gives the tank a base prowl ability of 35% in daylight and 60% in darkness. The tank is an all-terrain vehicle that can even ride water like a hydrofoil. It is an excellent infantry tank.

Model Type: XM-330

Class: Military Tank

Crew: Three: One pilot, a gunner and a communications officer. There are seats for two additional passengers and two others could squeeze in if they kneel (cramped).

M.D.C. by Location:

Main Cannon (1) — 300

* Ion Cannon (1; front) — 80

* Low Profile Laser Turret (1; top) — 100

* Mini-Missile Launchers (2; side of turret) — 50 each

* Smoke Launchers (3) — 10 each

* Forward Headlight (1) — 5

* Main Sensor (1; front) — 20

* Top Access Hatch (1) — 120

* Secret Belly Hatch (1) — 100

Reinforced Pilot's Compartment — 100

** Main Body — 700

* Every item marked by a single asterisk is small and/or difficult to strike. An attacker must make a called shot to hit and even then he is -3 to strike. Destroying both sensor units means the pilot must rely on his own vision; no radar, targeting, etc.

** Depleting the M.D.C. of the main body completely destroys the vehicle.

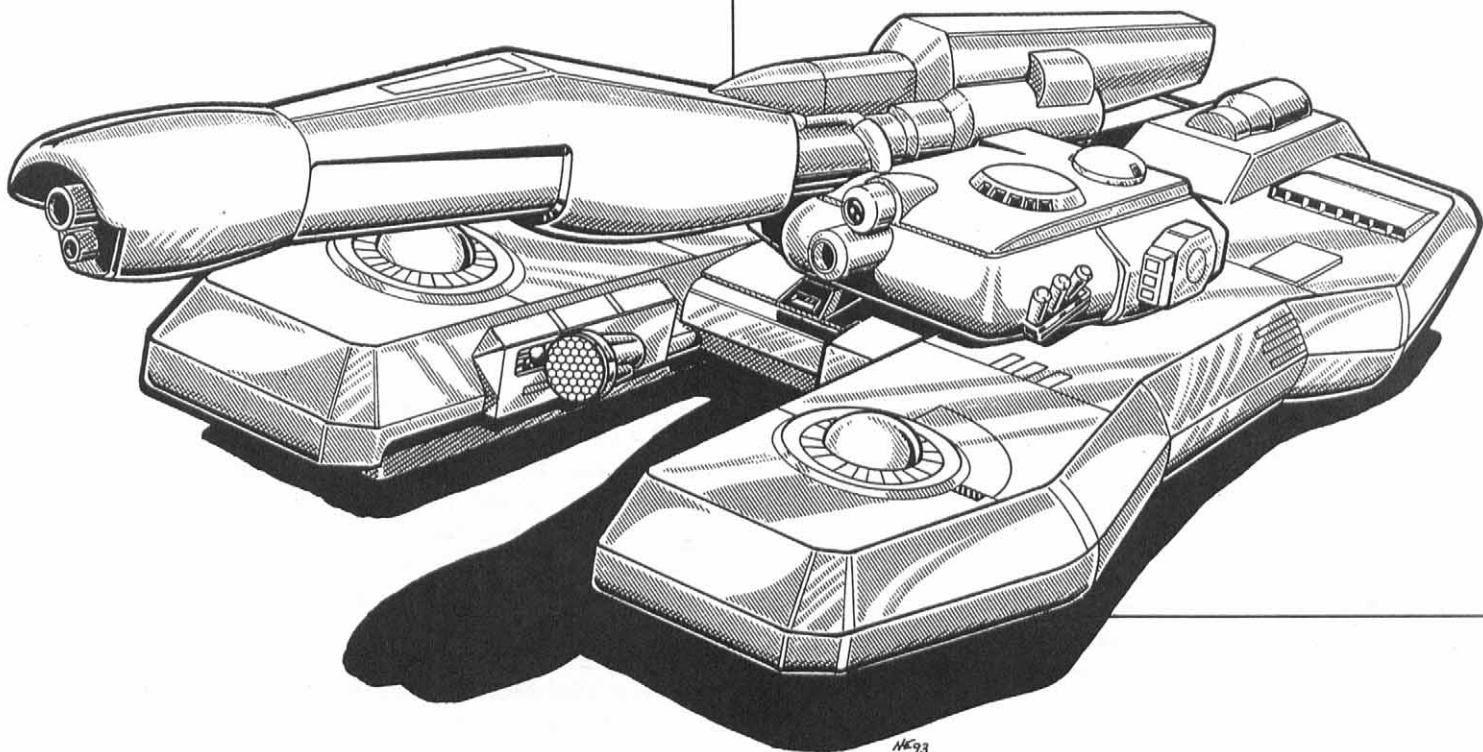

Speed

Land: 80 mph (128 km) maximum. The hover tank can ride on a cushion of air as low as two feet (0.6 m) off the ground or as high as six feet (1.8 m).

Water: 15 mph (24 km)

Air: Flight is not possible.

Statistical Data

Height: 9 feet (2.7 m)

Width: 20 feet (6 m)

Length: 35 feet (10.7 m)

Weight: 52 tons fully loaded.

Cargo: A small area inside that is large enough to stow three backpacks, canteens and rifles.

Color: Typically light grey, dark grey, blue, green or camouflage.

Power System: Nuclear, average energy life is 20 years.

Black Market Cost: Black market knock-offs cost 40 million credits and may not have the same weapon systems.

Weapon Systems

1. Main Gun: Double-barreled Cannon (1): The main gun is a long-range cannon built into a large turret. The larger barrel fires a particle beam. The smaller barrel underneath fires a long-range laser. The entire turret, which includes the short-range ion cannon, laser turret and mini-missile launchers, can rotate 360 degrees. The cannon barrels can be raised in a 45 degree arc of fire. The main gun is typically controlled by the gunner.

Main Gun: Particle Beam Cannon

Primary Purpose: Anti-Armor

Secondary Purpose: Defense

Mega-Damage: 2D4 × 10 M.D. per single blast!

Rate of Fire: Equal to number of combined hand to hand attacks (usually 3-6).

Maximum Effective Range: 3000 feet (914 m)

Payload: Effectively unlimited.

Main Gun: Laser Cannon

Primary Purpose: Assault/Anti-Armor/Anti-Monster

Secondary Purpose: Defense

Mega-Damage: 1D4 × 10 M.D. per blast. *Note:* A simultaneous blast from both cannons at the same target does 3D4 × 10

Rate of Fire: Equal to the gunner's hand to hand attacks per melee round (usually 3 to 6).

Maximum Effective Range: 4000 feet (1200 m)

Payload: Effectively unlimited.

2. Ion Cannon (1): The stubby barrel in the center of the weapon turret is a short-range ion cannon.

Primary Purpose: Assault

Secondary Purpose: Defense

Mega-Damage: 1D4 × 10 M.D. per blast.

Rate of Fire: Equal to the gunner's hand to hand attacks per melee round (usually 3 to 6).

Maximum Effective Range: 2000 feet (610 m)

Payload: Effectively unlimited.

3. Forward Rail Gun Turrets (2): Two rail gun turrets are located at the front of the tank. Each can rotate and angle up or down 45 degrees. They are typically controlled by the gunner or pilot.

Primary Purpose: Anti-personnel

Secondary Purpose: Defense

Mega-Damage: A burst fires 30 rounds and inflicts 1D4 × 10 M.D.; single rounds cannot be fired. A synchronized attack from both turrets firing simultaneously at the same target inflicts 2D4 × 10 M.D.

Rate of Fire: Equal to the character's hand to hand attacks per melee round (usually 3 to 6) plus one!

Maximum Effective Range: 4000 feet (1200 m)

Payload: 12,000 rounds (400 bursts) total; 6000 rounds (200 bursts) per each turret. The weapon is fed from a massive ammunition in the hull of the platform. Reloading a drum will take an experienced field mechanic 10 minutes.

4. Low Profile Laser Turret: Located at the rear top area of the main turret is a small, flat, disk-like turret with a small nozzle protruding from a small opening. The turret can rotate 360 degrees.

Primary Purpose: Defense

Mega-Damage: 3D6 M.D. per blast.

Maximum Range: 1200 ft (488 m).

Rate of Fire: Equal to that of the gunner.

Payload: Effectively unlimited.

5. Mini-Missile Launchers (2): On each side of the big turret is a small mini-missile launcher with three launch bays.

Primary Purpose: Anti-Aircraft/Gargoyle/Anti-Missile

Secondary Purpose: Assault

Missile Type: Any mini-missile can be used, but standard issue is armor piercing (1D4 × 10 M.D.) or plasma (1D6 × 10). Fragmentation will be used for anti-personnel operations.

Mega-Damage: Varies with missile type.

Range: Usually about a mile.

Rate of Fire: One at a time or a volley of two, or three.

Payload: 12 total, six in each launcher.

6. Smoke Grenade Launchers (3): Located near the mini-missile launcher opposite the main gun are three smoke grenade canisters. Each is fired separately and used to create cover. Same stats as the smoke grenade used by the X-60 Flanker.

Payload: Three

7. Sensors of Note: Long-range communication, radar, and radar tracking same as the robot vehicles.

8. Special Features: 1) Silenced Engine and Propulsion System: As stated previously, the XM-330 is so quiet that it actually gets a prowling roll! 35% in daylight and 60% in darkness.

2) The entire main turret can rotate 360 degrees.

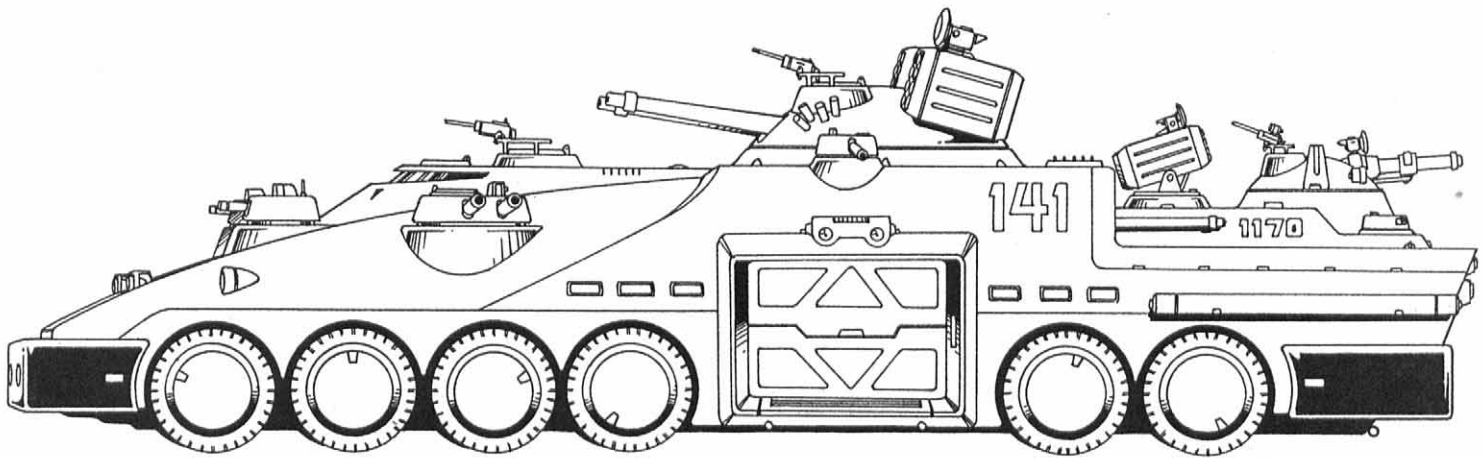

XM-350 Leopard III APC

The XM-350 Leopard is another one of Triax's giant war machines. In fact, it is so large that its rear cargo bay is designed to carry an XM-300 "Terror" mini-tank! When docked with the larger vehicle, the mini-tank backs into the bay and is locked in place. All of the mini-tank's weapon systems can be used by its crew while in transit. Thus, the "Terror" tank serves as a defense mechanism for attacks from behind. When it's time to disembark and engage in combat, a small ramp slides out of the XM-350, the locks release and the "Terror" mini-tank drives out, front first, and ready for combat. Other small vehicles, robots or troops can be placed in the "Terror Bay," but the XM-300 mini-tank is what it was designed for and is standard issue.

The Leopard has its own battery of short and long-range weapons, including four laser turrets, a main cannon and missiles. Inside the troop carrier are foot soldiers, power armor troops and bots.

Model Type: XM-350

Class: Military Armored Personnel Carrier and Assault Vehicle

Crew: Ten: One pilot, a co-pilot, communications officer, intelligence officer, and six gunners.

APC Troops Payload: Just about any mix of troops is feasible, but a standard infantry force includes:

- 20 to 28 Foot Soldiers (with or without jet packs)
- 4 X-10A Predators or X-535 or X-545 Jagers
- 4 DV-12 Dyna-Bots, or Super Troopers, or Glitter Boys
- 2 DV-40 Combat Drones or X-2000 Dyna-Max
- 2 Field Mechanics or Commandos
- 2 Field Medics
- 1 XM-50 Medical Pod
- 1 XM-300 Mini-Tank

M.D.C. by Location:

- * Main Gun: Ion Cannon (1) — 100
- * Medium Missile Launchers (2; toward rear) — 100 each
- * Side Rail Gun Turrets (2) — 50 each
- * Laser Turrets (4) — 100 each
- * Laser Guns (2; manned, front and back) — 30 each
- * Smoke Grenade Launchers (8) — 5 each
- * Forward Headlights (2) — 5 each

- * Searchlights (2; front, top sides) — 10 each
- * Main Sensor (1; on top of missile launcher) — 20
- * Top Access Hatches (3) — 70 each
- * Main Side Hatches (2) — 200 each
- * Hardened Wheels (12) — 50 each
- * High-Impact Bumper (1) — 200
- * Pilot/Crew View Port (1) — 75
- Reinforced Crew Compartment — 75
- ** Main Body — 900

* Every item marked by a single asterisk is small and/or difficult to strike. An attacker must make a called shot to hit and even then he is -3 to strike. Destroying the main sensor unit means the pilot must rely on his own vision; no radar, targeting, etc.

** Depleting the M.D.C. of the main body completely destroys the vehicle.

Speed

Land: 80 mph (128 km)

Water: Not amphibious.

Air: Flight is not possible.

Statistical Data

Height: 15 feet (4.6 m)

Width: 12 feet (3.6 m)

Length: 70 feet (21.3 m)

Weight: 89 tons unloaded.

Cargo: Troops and/or supplies can be carried inside the troop bay area. Likewise, additional troops, bots or cargo can be stowed in the "Terror Bay" instead of the XM-300 mini-tank.

Color: Typically light grey, dark grey, blue, green or camouflage.

Power System: Nuclear, average energy life is 20 years.

Black Market Cost: Black market knock-offs cost 80 million credits and may not have the same weapon systems.

Weapon Systems

1. **High-Powered, Double-barreled Ion Cannon (1):** The main gun is an ion cannon built into a large turret. The entire turret, which includes a sensor disk and man operated laser gun, can turn 360 degrees. The cannon itself can be raised in a 45

degree arc of fire. The main gun is typically controlled by the gunner.

Primary Purpose: Assault/Anti-Armor/Anti-Monster

Secondary Purpose: Defense

Mega-Damage: 1D4×10 M.D. per single blast or 2D4×10 M.D. per simultaneous double blast at the same target.

Rate of Fire: Equal to the gunner's hand to hand attacks per melee round (usually 3 to 6).

Maximum Effective Range: 3000 feet (914 m)

Payload: Effectively unlimited.

Bonus: +1 to strike.

2. Medium Range Missile Launchers (2): On the back of the ion cannon turret are two missile launchers. Both are fixed forward at an angle so the entire turret must turn to point them in a particular direction. However, the missiles are either heat seeking (+3 to strike) or smart bombs (+5 to strike) and recognize and pursue enemy targets, making trajectory adjustments in flight, so they can be launched from any position. Typically operated by one of the gunners.

Primary Purpose: Anti-Aircraft/Anti-Armor

Secondary Purpose: Defense

Missile Type & Mega-Damage: Any medium range missile can be used. Typically, plasma (2D6×10 M.D.) or multi-warhead (2D4×10 M.D.). Others can be substituted.

Range: Varies, 40 to 80 miles (to km).

Rate of Fire: One at a time or in volleys of two, three or four.

Payload: 16 total; eight per launcher.

3. Pulse Laser Turrets (4): A pair of turrets are mounted on the forward section of the vehicle. Two other laser turrets are located about 10 feet (3 m) behind and to the side of the two forward turrets. Each can rotate 360 degrees and the weapon barrels can be raised and lowered in a 45 degree arc of fire. Each of the two side turrets are operated by individual gunners. Typically the co-pilot and/or pilot operates the two forward turrets.

Primary Purpose: Assault

Secondary Purpose: Anti-Missile

Mega-Damage: 2D6 M.D. per single blast or 6D6 per triple pulse (the pulse counts as one melee action). Or the two front turrets can fire simultaneously at the same target, inflicting 1D6×10+6 M.D. (counts as one melee action).

Rate of Fire: Equal to the pilot's attacks/actions per melee.

Maximum Effective Range: 2000 feet (610 m)

Payload: Effectively unlimited.

4. Manned Laser Guns (2): A laser gun is mounted at the forward hatch on the main turret above the ion cannons and another near the top hatch of the crew compartment. To operate, one of the crew members must open the access hatch near the gun and manually fire it like a machinegun. The laser can move side to side 180 degrees and up and down in a 90 degree arc of fire.

Primary Purpose: Anti-Personnel

Secondary Purpose: Anti-Missile

Mega-Damage: 4D6 M.D. per blast.

Rate of Fire: Equal to the operator's hand to hand attacks per melee round (usually 3 to 6).

Maximum Effective Range: 2000 feet (610 m)

Payload: Effectively unlimited.

5. Side Rail Gun Turrets (2): Above each of the large side hatches where the troops disembark (one on each side of the APC) is a rail gun turret. Each can rotate 360 degrees and the barrel has a 45 degree arc of fire. They are typically controlled by one of the gunners.

Primary Purpose: Anti-personnel

Secondary Purpose: Defense

Mega-Damage: A burst fires 30 rounds and inflicts 1D4×10 M.D.; single rounds cannot be fired.

Rate of Fire: Equal to the character's hand to hand attacks per melee round (usually 3 to 6) plus one!

Maximum Effective Range: 4000 feet (1200 m)

Payload: 12,000 rounds (400 bursts) total; 6000 rounds (200 bursts) per each turret. The weapon is fed from a massive ammo-drum in the hull of the platform. Reloading a drum will take an experienced field mechanic 15 minutes.

6. Smoke Grenade Launchers (8): Located on either side of the main turret are four smoke grenade canisters. Each is fired separately and used to create cover. Same stats as the smoke grenade used by the X-60 Flanker.

Payload: 8; four on each side of the main turret.

7. Sensors of Note: Long-range communication, radar, and radar tracking same as the robot vehicles.

8. Special Features: 1) Twelve high impact, puncture proof tires. The vehicle can travel at full speed even if four of its tires have been destroyed. Reduce speed by 40% if six tires have been destroyed and by 90% if nine or more have been destroyed.

2) High impact bumper reduces impact/collision damage by 75%.

3) The entire main turret can rotate 360 degrees.

4) The ion cannon cleaning rods (2) are attached to the sides of the tank. They are used to clean dirt and particles from the barrels of the big guns.

5) Automatic locking hatches opened by voice recognition and/or by a number code punched in on an eight digit key pad.

6) Homing beacon and long-range radio communication.

7) Standard field equipment includes portable long-range radio, portable short-range radar, medical nano-bots, first aid kit, ten signal flares, 10 TX-42 energy rifles, and a two week supply of dehydrated food, and water, to feed the ten-man crew.

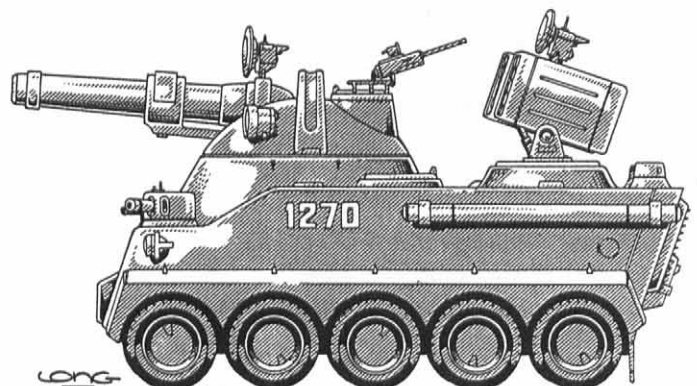

Triax MZ-10 Wilderness Crusader

The wilderness crusader is an exceptional all-terrain hover vehicle. It comes standard with a high-impact bumper, heavy armor, and ion weapon turret!

Vehicle Type: Armored Hover Vehicle
Class: Civilian

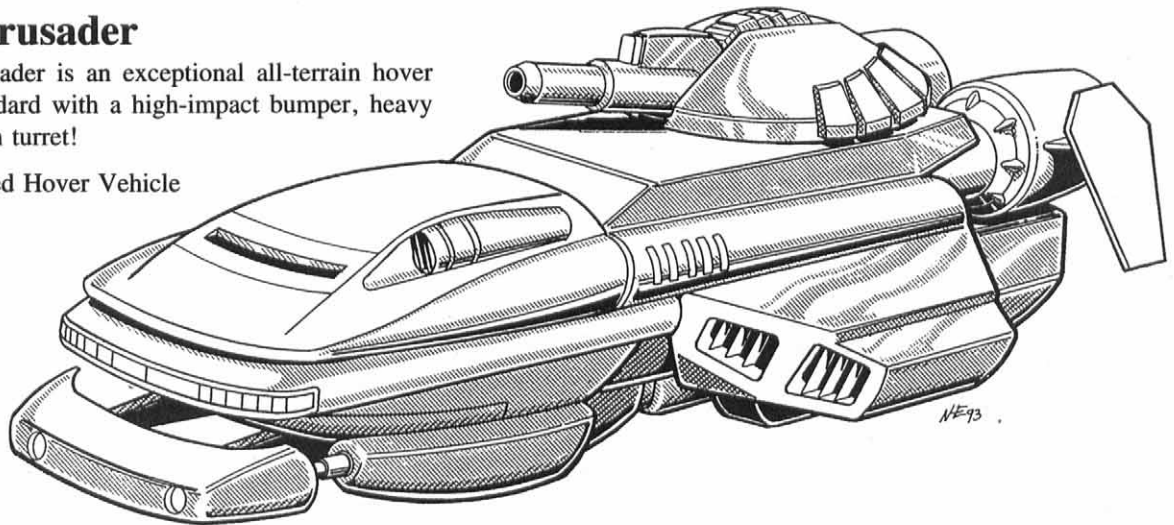

Crew: One pilot and seats six passengers comfortably.

M.D.C. by Location:

Forward Bank of Headlights (entire bank) — 15
Retractable Landing Gear (4) — 20 each
Lower Hover Jets (3; large) — 65 each
Rear Rocket Jets (2) — 125 each
High-Impact Windshield (1, slot) — 30
High-Impact Bumper — 100
Weapon Turret (1) — 150
Main Body — 310

Maximum Ground Speed: 160 mph (256 km). It hovers one to five feet above the ground (0.3 to 1.5 m) and is also amphibious!

Maximum Water Speed: 20 mph (32 km)

Length: 9 feet (2.7 m)

Weight: 1.2 tons

Cargo: An inner storage bay large enough to stow a dozen backpacks.

Power System: Gasoline or electric (nuclear power is optional at a cost of five million credits).

Maximum Range (gas or electric): 500 miles (480 km) before needing to refuel — unlimited if nuclear (10 year life).

Standard Weapon: Ion Cannon: The entire turret, which in-

cludes sensors laser targeting, can turn 360 degrees. The cannon barrel can be raised in a 45 degree arc of fire. The main gun is typically controlled by the driver or one of the passengers.

Primary Purpose: Defense in the Monster Zones.

Mega-Damage: 6D6 M.D. per single blast.

Rate of Fire: Equal to the gunner's hand to hand attacks per melee round (usually 3 to 6).

Maximum Effective Range: 2000 feet (610 m)

Payload: Effectively unlimited.

Bonus: +1 to strike.

Note: The cannon is not as powerful as most military issue, but a mechanic could upgrade the systems (1D4 × 10 M.D. with a 3000 foot range).

Additional Weapons & Sensor Systems: Optional; a light laser, ion gun or rail gun can be typically mounted on the front or top of the crew compartment. A mini-missile system can be built into the turret. Two missiles can be launched from each of the eight plates on the lower rear portion of the turret (four on each side; 16 mini-missiles total).

Additional Main Body Armor: 25,000 credits per 10 M.D.C.; a total of 100 M.D.C. can be added.

Market Cost: 3.5 million credits; good availability.

WR-1010 Land Rover

A popular, balloon tire, four-wheel drive, all-terrain vehicle. This vehicle is used by wilderness folk, adventurers and bandits. It is comparatively inexpensive and requires low maintenance.

Vehicle Type: Automobile

Class: Civilian

Crew: One pilot; seats four passengers comfortably.

M.D.C. by Location:

Forward Headlights (2) — 5 each
High-Impact Windows (3) — 30 each
Tires (4) — 10 each
Main Body — 100

Maximum Speed: 180 mph (288 km)

Length: 18 feet (5.5 m)

Weight: 2 tons

Cargo: A storage area large enough to stow four or five backpacks, canteens and rifles.

Power System: Gasoline or electric (nuclear costs 2 million extra).

Maximum Range: 300 miles (480 km) before needing refueling — unlimited if nuclear (5 year life).

Market Cost: 28,000 credits; excellent availability.

Weapons & Sensor Systems: Optional

Additional Main Body Armor: 25,000 credits per 10 M.D.C.; a total of 100 M.D.C. can be added.

Market Cost: 28,000 credits; excellent availability.

WR-2020 "Shark"

Bullet Bike

The bullet bike is a rocket-shaped, jet propelled hover cycle that is the rage among city rats, wilderness scouts and bandits.

Vehicle Type: Hover cycle

Class: Civilian

Crew: One pilot and seats one passenger comfortably.

M.D.C. by Location:

Forward Headlights (2) — 5 each

Landing Gear (3) — 15 each

Lower Hover Jets (2) — 35 each

Rear Rocket Jet (1) — 75

High-Impact Windshield (1) — 30

Main Body — 80

Maximum Speed: 280 mph (448 km)! The bike can hover one to five feet above the ground (0.3 to 1.5 m). -15% on piloting skill when travelling at speeds in excess of 200 mph (321 km). The bullet bike is not amphibious.

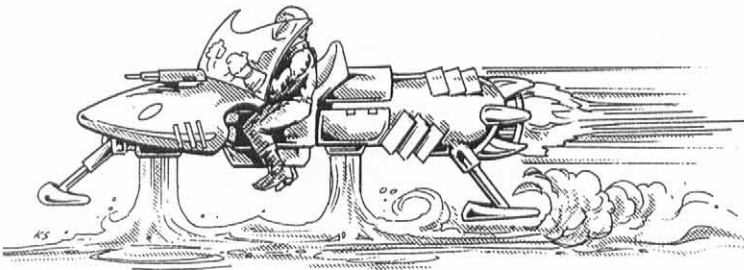

Jet Propelled Jumps: Up to 50 feet (15.2 m).

Length: 9 feet (2.7 m)

Weight: 1200 pounds (540 kg)

Cargo: Three small storage compartments behind the pilot are large enough to stow one backpack in each.

Power System: Gasoline or electric (nuclear power is optional at an additional cost of 2 million credits).

Maximum Range: 500 miles (480 km)

Weapons & Sensor Systems: Optional; a light laser, ion, or rail gun is typically mounted on the front. A mini-missile system (six missile payload) can be mounted behind the seat, but this means no passenger can ride the bike and one of the three storage compartments is no longer available.

Additional Main Body Armor: 25,000 credits per 10 M.D.C.; a total of 80 M.D.C. can be added.

Market Cost: 65,000 credits; excellent availability.

WR-5050 Super Cargo Hauler APC

The Super Explorer APC is a gigantic all-terrain vehicle used for hauling cargo. They are also used for research, exploration, and as an APC by corporations, scientific research teams, kingdoms, cities and businesses outside the NGR and by wealthy adventurers (and bandits).

Vehicle Type: Armored APC Vehicle

Class: Civilian

Crew: Three: Pilot, co-pilot, and gunner. It can seat 12 passengers comfortably and has a large cargo bay bigger than a box car or semi-trailer.

M.D.C. by Location:

Forward Video Cameras (6) — 10 each

Forward Round Headlights (6) — 5 each

Forward Laser Turret (1) — 50

Side Hatches (2; one on each side) — 100 each

Giant Metal Wheels (8) — 100 each

Rear Booster Jet (one; large) — 125

Rear Folding Ramp (1) — 100

Rear Cargo Doors (2; large) — 200 each

Rear Crew Bunk Area (1) — 240

Forward High-Impact Windshield (1) — 70

Windshield Protective Cover (1) — 100

Main Body — 400

Maximum Speed: 120 mph (192 km).

Height: 20 feet (6 m) for the main body. 32 feet (9.7 m) including the rear bunk area.

Width: 18 feet (5.4 m) wide.

Length: The main body is 60 feet (18.3 m) long. The rear bunk area adds another 20 feet (6 m), for a total length of 80 feet (24.4 m)!

Weight: 124 tons unloaded. The hauler can carry an additional 135 tons.

Cargo: A huge cargo area: 45 feet (13 m) long, 15 feet (4.6 m) wide and 15 feet (4.6 m) high. That's 675 square feet of floor space.

Power System: Gasoline or electric (nuclear power is optional at a cost of 12 million credits).

Maximum Range (gas or electric): 200 miles (320 km) before needing fuel — unlimited if nuclear (20 year life).

Standard Weapon: Forward Laser Turret: The entire turret, which includes sensor and laser targeting, can turn 180 degrees. The cannon barrel can be raised in a 90 degree arc of fire. It is typically controlled by the driver or co-pilot.

Primary Purpose: Defense in the Monster Zones.

Mega-Damage: 3D6 M.D. per single blast.

Rate of Fire: Equal to the gunner's hand to hand attacks per melee round (usually 3 to 6).

Maximum Effective Range: 2000 feet (610 m)

Payload: Effectively unlimited.

Bonus: +1 to strike.

Note: The cannon is not as powerful as most military issue, but a black market mechanic or arms dealer could upgrade the system.

Special Features: 1) **Rear Crew Bunk Compartment:** This is the big, rear tower-like section in the back of the vehicle. It has comfortable beds for ten, lounge area with television and sound system, a private lavatory, and a kitchenette with sink and refrigerator, plus a 200 gallon (756 liters) water cooler. This facility is ideal when on the road for days or weeks at a time making deliveries.

2) Long-range communications disk, long-range radar and sensor system. The sensor system and radar/communications disk is mounted on the crew compartment with monitoring stations in the crew compartment and front driver's area. Full sensor systems equal to most military bots and vehicles.

3) The forward driver's/crew compartment has a large, high-impact windshield plus has metal blast shields that can seal the window airtight (100 M.D.C.). When the window is covered by the protective shield, the pilot operates via video images and sensor data displayed on monitors and/or

HUD system. The six rectangular boxes recessed in the front of the vehicle are video cameras.

4) Automatic locking hatches opened by voice recognition and/or by number code punched in on an eight digit key pad.

5) Homing beacon and long-range radio communications.

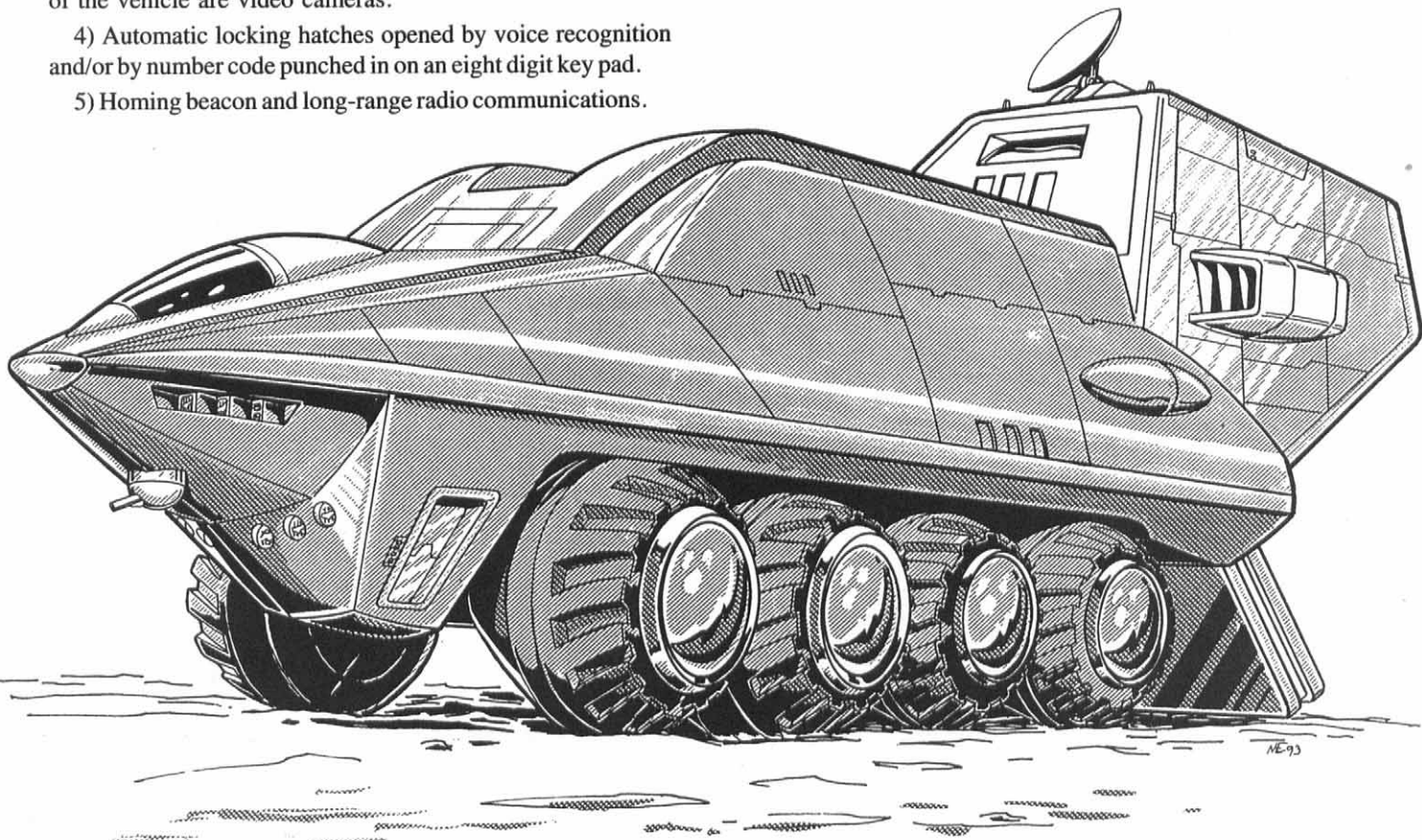

Additional Weapons & Sensor Systems: Optional. As many as four weapon mounts or turrets can be added, as well as one or two (depending on their size) mini-missile systems (probably 8 to 16 missiles per launch system).

Some institutions and corporations have transformed the cargo area into a full, mobile medical or scientific research facility with laboratories and sensor stations.

Additional Main Body Armor: 25,000 credits per 10 M.D.C.; a total of 300 M.D.C. can be added.

Market Cost: 45 million credits; fair to good availability.

WR-5054 Mini-Cargo Hauler APC

The mini-cargo hauler looks just like the WR-5050 Super without the rear bunk compartment and is a third its size.

Vehicle Type: Armored APC Vehicle

Class: Civilian

Crew: Three: Pilot, co-pilot, and gunner. It can seats six passengers comfortably and has a cargo area the size of a full-size 20th Century van.

M.D.C. by Location:

Forward Video Cameras (4) — 10 each

Forward Round Headlights (4) — 5 each

Forward Laser Turret (1) — 30

Side Hatches (2; one on each side) — 50 each

Giant Metal Wheels (6) — 50 each

Rear Booster Jet (one; large) — 65

Rear Folding Ramp (1) — 50

Rear Cargo Door (2; large) — 100

Forward High-Impact Windshield (1) — 35

Windshield Protective Cover (1) — 60

Main Body — 200

Maximum Speed: 150 mph (240 km).

Height: 11 feet (3.3 m)

Width: 7 feet (2.1 m)

Length: 20 feet (6 m)

Weight: 5 tons unloaded. It can carry an additional 10 tons.

Cargo: About the size of a van or small truck.

Power System: Gasoline or electric (nuclear is optional at a cost of 5 million credits).

Maximum Range (gas or electric): 200 miles (320 km) before needing fuel — unlimited if nuclear (10 year life).

Standard Weapon: Forward Laser Turret: Same as the Super.

Special Features: 1) The forward driver's/crew compartment has a large high-impact windshield plus a metal blast shield that can seal the window airtight (60 M.D.C.). When the window is covered by the protective shield, the pilot operates via video images and sensor data displayed on monitors and/or HUD system. The four rectangular boxes recessed in the front of the vehicle are video cameras.

2) Automatic locking hatches opened by voice recognition and/or by a number code punched in on an eight digit key pad.

3) Homing beacon and short-range radio communications.

Additional Weapons & Sensor Systems: Optional. As many as two weapon mounts or turrets can be added, as well as one mini-missile system (8 missiles).

Additional Main Body Armor: 25,000 credits per 10 M.D.C.; a total of 200 M.D.C. can be added.

Market Cost: 45 million credits; fair to good availability.

Other Vehicles

A variety of conventional gasoline motorcycles, automobiles, and trucks, as well as hover vehicles, are also available. See the **Rifts RPG** for some basic ideas of types, features and costs.

Weapons

Note: The following descriptions are of weapons commonly used in and around the New German Republic. The majority are designed and manufactured by Triax. All Triax weapons are identified with the "TX" prefix or the word Triax. Lasers are among the most common human energy weapons because they offer the greatest range (ion and particle beams rarely exceed 1600 feet/488 m unless they are giant-sized).

Prices listed: In the cities and most NGR villages, mainstream items can vary by 10% to 20%, up or down, depending on the seller and market demands. In the wilderness, items can cost two to four times more; seldom less, unless stolen. Items listed with a "Black Market" cost are not normally available to the average character, are frequently illegal contraband, and can only be purchased from the Black Market, bandits, mercenaries or gypsies. NGR soldiers are likely to confiscate any Black Market items brought into the territory controlled by the Republic. However, they will often ignore characters with contraband weapons in the wilderness, particularly in the Monster Zones, unless they are suspected as enemies of the NGR.

M.D.C. of Typical Items: The average energy pistol or vibro-blade has 10 M.D.C., an energy rifle 20 to 30 M.D.C., a rail gun 50 to 75 M.D.C., while giant-sized weapons for bots, borgs and power armor have 75 to 100 M.D.C. points.

Energy-Clips

1. Triax Forward Sliding Clip (FSE-clip): Most Triax weapons use a forward facing, sliding E-clip rather than the handle style clip used in automatic weapons and by the Coalition States. The energy clip fits snugly into the front housing and can be used as a handhold or grip for two-handed firing by the shooter. This design also means the E-clip can be larger and hold a dramatically larger payload.

Note: The front loading E-clip makes the weapon a bit unbalanced when shooting one-handed, pulling the front down (-2 to strike), but has good balance and accuracy when braced with two hands and is therefore, more accurate (+1 to strike). Also note that virtually ALL rifles of any kind are designed as two-handed weapons for maximum accuracy, and are -1 to strike when fired with one hand.

Typical payload for the FSE-clip: 40 or 50 shots for pistols/handguns or 20 to 40 shots for rifles.

Cost: A typical FSE-clip costs 17,000 credits. Recharge cost is 5000 credits — an energy clip can be recharged to full payload for about one-third of its original cost.

2. Triax Short Clip: Some energy pistols and older style weapons can only use the more traditional handle-loaded energy clip, usually referred to as a "short" clip. Many cybernetic/bionic weapon systems also need the smaller magazine. Many of the new Triax weapons have housings for both, giving the weapon greater versatility.

Typical payload for the short E-clip: 10 to 20 shots for pistols/handguns, or 8 to 10 shots for rifles.

Cost: A typical short E-clip costs 9,000 credits. A recharge to full power costs about 2000 credits.

Note: In the wilderness, a character may find himself at the mercy of unscrupulous businessmen who charge double to quadruple for E-clips and recharging. Energy weapons and common equipment rarely costs more than double.

3. Costs for Conventional S.D.C. Rounds: Available S.D.C. rounds/bullets include all the common types, from .22 caliber to 10 mm. Armor piercing rounds (add 1D6 S.D.C. to the bullet's damage) or high explosive cartridges (add 1D4 × 10 S.D.C.) are also available. A box of 48 rounds (normal bullets) typically costs about 10 credits. Triple for armor piercing, dum-dums, and other special rounds. One hundred credits for a box of 48 exploding rounds.

4. Costs for Pump Rounds: High explosive mini-grenades cost 300 credits each; a box of 48 is 14,400 credits.

5. Costs for Hand Grenades: 100 to 400 credits each, depending on the type and availability.

Depleted Uranium Rounds

aka DU-Rounds

Depleted Uranium rounds are special rail gun cartridges made from old nuclear material with only trace levels of radiation. The material is much heavier than normal slugs, giving it much greater armor piercing and damage capability. DU-Rounds do not have enough radiation to inflict additional damage or prevent healing in supernatural beings, unlike the U-Rounds.

Primary Purpose: Anti-Armor

Mega-Damage: Depleted Uranium slugs inflict 1D6 × 10 M.D. from a standard burst of 30 rounds fired from a rail gun or 1D4 × 10 M.D. for a 20 round burst. They typically do 25% more damage than a comparable standard metal cartridge.

Cost: Not commonly available. The Black Market or bandits occasionally sell a single round for around two to five credits per each.

Uranium Rounds

aka U-Rounds — Exclusive to the NGR

One of the great threats from supernatural monsters such as alien intelligences, gods, demons, the Four Horsemen of the Apocalypse, elementals, vampires, dragons, and supernatural beings in general, is that they have incredible powers of bio-regeneration. Most are impervious to fire, cold, poison and radiation. In many instances, they can restore hundreds of points of mega-damage in a matter of minutes. Many can completely regrow amputated limbs and damaged internal organs. Even some of the lesser so-called demons, including werewolves, brodkil and gargoyles, have healing and regenerative powers far greater than humans.

Mega-damage from plasma, lasers, and other energy attacks is healed in an instant, without any trace of burns or scarring. Conventional mega-damage projectiles are dissolved in the body and disappear, or are painlessly pushed out — ejected by the

super healing powers of these incredible beings. Some may have vulnerabilities to common items like silver or a wooden stake, but still they are dangerous creatures who recover from damage quickly.

Frequently, combatants of the supernatural find they must completely destroy the monster in the initial battle, using methods of overkill to accomplish the task. To let the fiend crawl off into the shadows means it will recover (sometimes in a matter of minutes) and seek revenge. These demonic beings have a very different sense of mortality than humans. They don't understand lingering pain, or fear accumulative damage. Consequently, they enter combat without fear, confident of their triumph. If they suffer too much damage, they simply flee to a temporarily safe haven, heal and return to fight the next day (or even later that night). However, the NGR has made a recent discovery that will strike fear into the hearts of fearless monsters and teach supernatural denizens the meaning of pain and mortality!

Triax has learned that the phenomenal healing powers of most (92%) supernatural menaces and creatures of magic are seriously impaired by radioactive material. Not radiation itself, but radioactive material that penetrates the skin. This has led to the development of a special type of rail gun projectile/bullet. A low radiation round called **Uranium Rounds** or more commonly known as **U-Rounds**.

Increased Damage & Reduced Healing

U-Rounds inflict 25% additional damage to supernatural beings (the same as DU rounds), but more importantly, they prevent the creature from instantly regenerating. The damage inflicted by U-Rounds cannot be healed until the object is physically removed, thereby dramatically reducing the threat from that being.

Even after the U-Rounds are removed, the wounds/damage do not heal quickly. Thus, another frightening, new experience for supernatural beings! The creature can heal completely with time, but only after the radioactive projectiles have been removed and a much longer time to heal is required than these monsters are accustomed to. Mega-damage that can usually be healed in a matter of *melee rounds* (seconds) takes the equivalent time in hours. Damage that normally heals in *minutes* takes the equivalent time in days! Damage healed in hours takes the equivalent time in weeks!!

For example: An adult dragon is invulnerable to radiation and can heal massive amounts of mega-damage inflicted by energy weapons, explosives, rail guns and magic. However, damage inflicted by **U-Rounds** cannot be healed until the bullets are physically removed, just like a bullet must be removed from a human to heal properly.

This means an evil dragon with 1000 M.D.C. gets embroiled in a battle with NGR troops. They are armed with rail guns and Uranium round ammunition. The dragon suffers a total of 600 points of mega-damage. 320 points of damage are from U-rounds. There's a pause in the combat. The dragon grins and performs bio-regeneration. The process restores 280 points in an instant. However, the 320 M.D. inflicted by U-Rounds is not restored. Until the dragon can get the rounds surgically removed, they remain painful, open wounds that bleed and hurt.

The monster's grin turns into a look of confusion or panic. A hint of fear shows in its eyes as the beast makes a bid for escape. The dragon finds a place to hide and tries to regenerate again. Nothing. Terror swells up from its nervous stomach. This is impossible! It has always been able to restore itself. The mighty beast tries again, but its condition remains unchanged.

This time it is the soldiers who are confident. They realize the creature is still supremely powerful and dangerous in the extreme, but they also know that every time they strike with U-Rounds, the dragon sustains more damage. Unable to regenerate, the creature is more vulnerable with each encounter. If they can track it down and corner it, they have an excellent chance of slaying it. In the past, they'd have to work quickly to locate their opponent within a matter of minutes or face a restored and angry dragon. U-Rounds give them the luxury of time — hours, days or even weeks.

For the first time in its life, the dragon feels true vulnerability. In the past, the dragon would hide for half an hour, regenerate completely and reappear to reap its vengeance. Now it must flee, find somebody to help remove the bullets and hide for days or weeks until it can heal! During this period of healing, the dragon is below its full strength and vulnerable to new attacks. Whether a new attacker uses U-Rounds, energy weapons or magic, the monster is still weakened, in pain and more easily slain. **Note:** Magic potions, herbs and healing spells are also affected by the U-Rounds' damage to supernatural beings and creatures of magic, restoring only half their normal healing amount. If the U-Rounds are removed first, then the magic has full effect. Psychic healers/surgeons are especially helpful in removing these slugs and treating these characters.

The Problems with U-Rounds

Uranium Rounds have a low level of radiation so they must be used with caution. The radiation level from a single round is so low that a human could carry it around for weeks with no ill effects from radiation. However, after a couple of months the character might suffer from radiation poisoning. More likely, such exposure would contribute to the person developing cancer or blood disease 2D4 years later.

An entire weapon magazine or ammo-drum of U-Rounds are too "hot" to handle safely for more than a few hours. Again, radiation sickness or cancer are of grave concern. Even environmental body armor is not guaranteed protection, especially when exposed for weeks at a time in the field of combat. For this reason, the use of Uranium Rounds is typically restricted to rail guns used by cyborgs and robots. Robot vehicles are self-contained, radiation proof environments. Smaller bots and cyborgs have better radiation shielding than body armor and no (or few) human components to damage. The belt that feeds the rounds into the gun is sealed and radiation proof. The ammo-drums containing hundreds to thousands of rounds are heavily shielded containers. This is considered the only "safe" usage of the radioactive material.

There is also the issue of damage to the environment. A couple hundred stray rounds will not noticeably damage the environment, but in a big fire fight, tens of thousands to millions of rounds could be expended. Where the largest concentration of Uranium Rounds are located the greater the damage to the environment and the greater the risk to human life! An area peppered

by U-Rounds will register dangerous levels of radiation. Vegetation will be stunted — smaller, shriveled and discolored. There aren't likely to be strange mutations, just an absence of healthy life. D-bees or humans living in the area will show a dramatically higher incidence of cancer, blood disease and birth defects. The ground and ground water could also become contaminated and hazardous to humans.

For all of these reasons, the use of U-Rounds is restricted and carefully monitored. In many instances after a successful battle, a "clean-up" team will examine the area, collecting as many of the U-Rounds as possible; typically a 50% to 80% clean-up rate. The use of Uranium rounds is frequently denied within the borders of the New German Republic, but often authorized for campaigns outside the nation, especially deep in enemy territory and against monster strongholds. Special squads may be authorized to use the ammunition for engagements with powerful supernatural beings even within the NGR. The logic being that the risks from the U-Rounds are less than letting a dangerous monster prowl city streets.

Note: Uranium Rounds are top secret! Triax and the leaders of the NGR have kept their discovery from allies and even the lower ranks of the military. Only elite commandos, trusted intelligence officers and robot fighter pilots may know about U-rounds, and even many of them don't understand the principles, dangers or elements behind the new round. In many circumstances, the soldiers may not even be told about the bullets. All they know is that the "new" or "special" ammunition they've been given seems to be extremely more effective against the enemy and that's good enough for them. This information will not be shared with the Coalition States until the alliance is signed (even then the NGR may hold back its secret).

The following supernatural or magic creatures (among others) are effected by U-Rounds: Gargoyles, brodkil, dragons, sphinxes, unicorns, zavors, Splugorth, vampires, werebeasts, ghouls, most gods, alien intelligences, demons, deevils, earth elementals, ice elementals and most supernatural beings or so-called demons.

They are not effective against fire, air or water elementals, entities, temporal raiders, spectres, and other energy beings. **Black Market Cost:** 10 credits a round, but can range from half that cost to twice as much.

Pistols

TX-5 Triax Pump Pistol

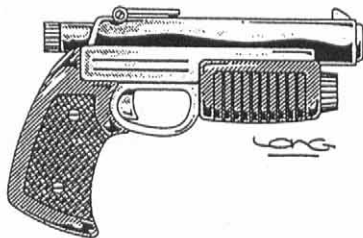

The TX-5 is a pistol version of the pump rifle. The weapon fires high explosive cartridges/bullets/rounds which are much smaller than the conventional grenade, but pack a wallop. These explosive rounds are fired at a high velocity, have good range, and contain a powerful explosive charge. The blast is very concentrated, about a one foot (0.3 m) area, unlike the larger grenades which affect an area five to twenty times larger.

Weight: 5 lbs (2.25 kg)

Mega-Damage: 4D6 M.D.

Rate of Fire: Standard, see Modern Weapon Proficiency Section.

Maximum Effective Range: 800 feet (224 m)

Payload: 5 rounds, loaded manually, one round per melee action.

A speed loader will load all five rounds in four seconds (one melee action) and costs 1200 credits.

Note: A "pump" weapons can also fire DU-Rounds or U-Rounds (only 1D6 M.D. per round but both are excellent armor piercing cartridges and the U-Rounds prevent supernatural beings from instant healing).

Market Cost: 10,000 credits for the gun and 400 credits per round. Fair availability.

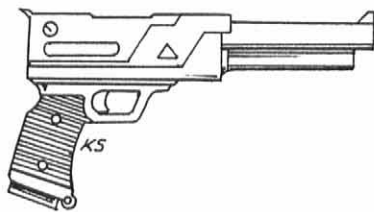

TX-20 "Short" Laser Pistol

The TX-20 Short is the standard issue sidearm for officers and police in the NGR's armed forces. It is an older style weapon that use a "short" E-clip but has good firepower and is lightweight and reliable.

Weight: 2 lbs (0.9 kg)

Mega-Damage: 2D6 M.D.

Rate of Fire: Standard, see Modern Weapon Proficiency Section.

Effective Range: 800 feet (224 m)

Payload: 20 shots.

Market Cost: 12,000 credits. Good Availability.

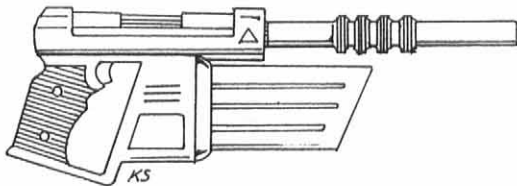

TX-22 Precision Laser Pistol

The TX-22 comes standard with a forward sliding energy clip, but can also use a short clip fitted into its handle. This is a long-range weapon with fine calibrations, ideal for target shooting.

Weight: 3 lbs (1.4 kg)

Mega-Damage: 2D4 M.D.

Rate of Fire: Standard, see Modern Weapon Proficiency Section.

Effective Range: 1000 feet (305 m)

Payload: 50 shots from an FSE-clip or 20 from a short clip.

Bonus: +1 to strike on an aimed shot.

Market Cost: 15,000 credits. Good Availability.

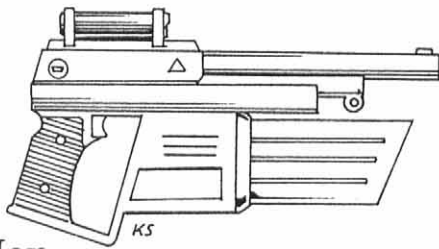

TX-24 Ion Pulse Pistol

The TX-24 comes standard with a forward sliding energy clip, but can also use a short clip fitted into its handle.

Weight: 4 lbs (1.8 kg)

Mega-Damage: 2D4 M.D. per single shot or 4D6 multiple pulse burst (three simultaneous shots).

Rate of Fire: Standard, see Modern Weapon Proficiency Section.

Effective Range: 500 feet (152 m)

Payload: 30 shots from an FSE-clip or 10 from a short clip.

Market Cost: 20,000 credits. Good availability.

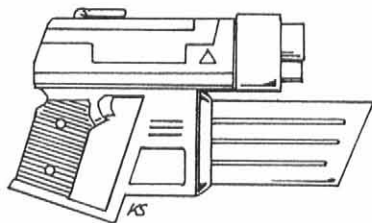

TX-26 Particle Beam Pistol

The TX-26 comes standard with a forward sliding energy clip, but can also use a short clip fitted into its handle. The amount of energy used by each particle beam charge limits the payload more than for any other weapon.

Weight: 5 lbs (2.25 kg)

Mega-Damage: 5D6 M.D. per shot

Rate of Fire: Standard, see Modern Weapon Proficiency Section.

Effective Range: 400 feet (122 m)

Payload: 15 shots from an FSE-clip or 6 from a short clip.

Market Cost: 35,000 credits. Fair availability.



WR-10 Wilderness Ion Pistol

The WR-10 is an old style weapon that use a "short" E-clip but has good firepower and is lightweight and reliable. The design is that of a Pre-Rifts sub-machinegun with a short shoulder stock

Weight: 2 lbs (0.9 kg)

Mega-Damage: 2D4 M.D.

Rate of Fire: Standard, see Modern Weapon Proficiency Section.

Effective Range: 600 feet (183 m)

Payload: 20 shots.

Market Cost: 10,000 credits. Excellent availability.

Rifles

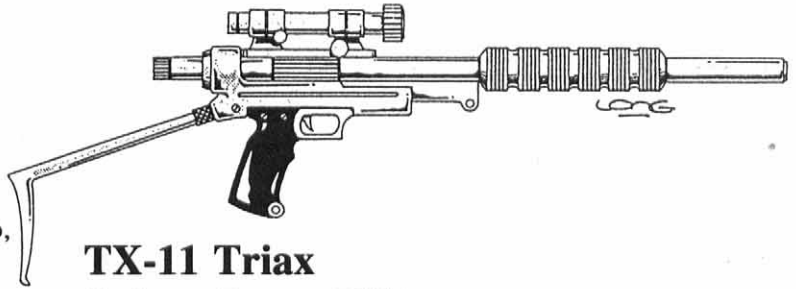

TX-11 Triax Sniper Laser Rifle

A light laser rifle designed for single shots and maximum accuracy. Comes standard with an infrared telescopic sight.

Weight: 3 lbs (1.35 kg)

Mega-Damage: 3D6 M.D.

Rate of Fire: Equal to the number of hand to hand attacks of its operator; aimed shots only. Can not fire bursts.

Maximum Effective Range: 1600 feet (488 m)

Payload: 10 shots "short" clip or 20 shots FSE Clip.

Special Bonus: +1 to strike (so an aimed shot is +5).

Black Market Cost: 20,000 credits. Fair availability.

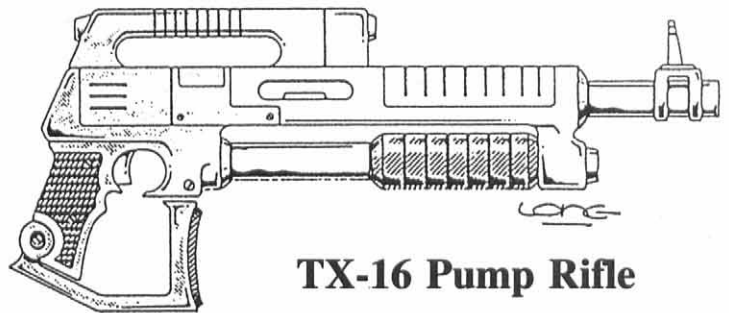

TX-16 Pump Rifle

The pump rifle is a new concept in mega-damage assault rifles that uses projectiles rather than energy blasts. Some have called the TX-16 a glorified grenade launcher or shotgun, but regardless of its detractors, the weapon has become increasingly popular, particularly among wilderness people. The rifle fires high explosive cartridges/bullets/rounds which are much smaller than the conventional grenade, but pack a wallop. These rounds are fired at a high velocity, have good range, and contain a powerful explosive charge. The blast is very concentrated, about a one foot (0.3 m) area, unlike the larger grenades which affect an area five to twenty times larger. The TX-16 Pump is a bit heavy, but well balanced and dependable in combat.

Weight: 21 lbs (9.45 kg)

Mega-Damage: 4D6 M.D.

Rate of Fire: Standard, see Modern Weapon Proficiency Section.

Maximum Effective Range: 1600 feet (488 m)

Payload: 16 rounds, loaded manually, one round at a time (i.e., one round per melee action). A speed loader will load eight (8) rounds in four seconds (one melee action) and costs 2000 credits.

Note: A "pump" weapon can also fire DU-Rounds or U-Rounds but these cartridges: only 1D6 M.D. per round. However, they have excellent armor penetration and U-Rounds prevent supernatural beings from instant bio-regeneration.

Market Cost: 30,000 credits for the gun and 200 credits per explosive round. Fair availability.

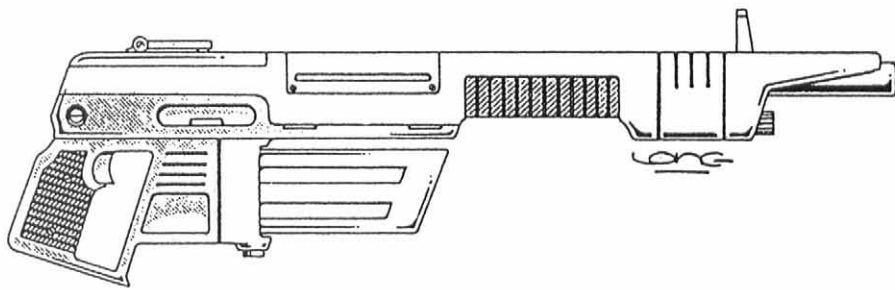

TX-30 Triax Ion Pulse Rifle

A popular frontier weapon with a front loading E-clip. It is a dependable, lightweight weapon with the benefit of multiple ion bursts and excellent range.

Weight: 7 lbs (3 kg)

Mega-Damage: 2D6 M.D. single shot, or 6D6 multiple pulse burst (three simultaneous shots).

Rate of Fire: Standard, see Modern Weapon Proficiency Section.

Maximum Effective Range: 1600 feet (488 m)

Payload: 40 shots, short E-Clip or 50 shots, long E-Clip.

Market Cost: 22,000 credits. Good availability.

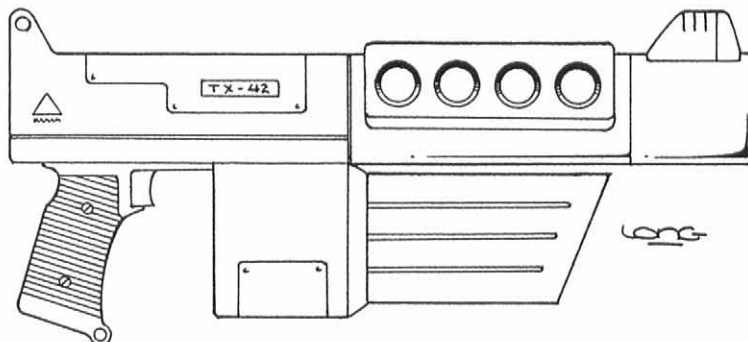

TX-41 Laser Pulse Rifle (Giant Size)

This is a giant version of the TX-42 pulse rifle used by giant-sized robots and power armor (bots that stand 10 to 20 feet/3 to 6 m tall). The weapon is also a variable frequency laser with 12 different light frequencies. The operator can change frequencies with a touch or voice command. An internal computer makes the desired change. Number 7 counters the USA-10 Glitter Boy. The other settings are able to overcome other laser resistant armors.

Weight: 20 lbs (9.1 kg)

Primary Purpose: Assault

Mega-Damage: 3D6 M.D. per single shot or 1D6 × 10 M.D. per rapid-fire pulse (three nearly simultaneous shots).

Rate of Fire: Equal to the total number of hand to hand attacks.

Effective Range: 4000 feet (1200 m)

Payload: 100 shots from the giant, energy clip located in the front of the gun. A special cable can connect the weapon to a robot's energy supply, giving it an effectively unlimited payload. The danger is that the weapon is rendered useless if the cable is cut.

Black Market Cost: 90,000 to 120,000 credits. This weapon is not sold to the mass market so it is available only on the black market. The military and law enforcement agencies of the NGR consider it an illegal weapon when in the possession of non-military personnel and will confiscate it. Very poor availability.

TX-42 Laser Pulse Rifle

This is the standard energy assault weapon used by the human troops of the NGR's armed forces. The weapon is also a variable light frequency laser with 12 different settings. The operator can change frequencies with a touch or voice command. An internal computer makes the desired change. Number 7 counters the USA-10 Glitter Boy. The other settings are able to overcome other laser resistant armors.

Weight: 9 lbs (4 kg)

Primary Purpose: Assault

Mega-Damage: 2D6 M.D. per single shot or 1D4 × 10 M.D. per rapid-fire pulse (three nearly simultaneous blasts fired one micro-second after the other).

Rate of Fire: Equal to the total number of hand to hand attacks.

Effective Range: 2000 feet (610 m)

Payload: 40 shots, with a FSE clip.

Black Market Cost: 50,000 to 75,000 credits. This weapon is not sold to the mass market so it is available only on the black market. The military and law enforcement agencies of the NGR consider it an illegal weapon when in the possession of non-military personnel and will confiscate it. Poor availability.

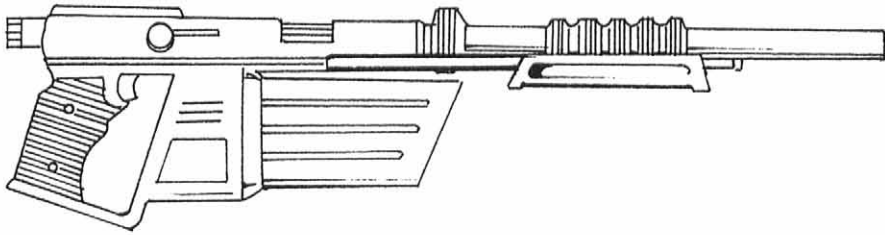

TX-43 Light Assault Laser Rifle

The TX-43 is a long-range, all-purpose laser weapon with three damage settings. It is a sturdy and reliable weapon popular among adventurers and mercenaries. The forward sliding energy clip is standard, but a short clip can fit into its handle.

Weight: 7 lbs (3 kg)

Damage: Three settings: 6D6 S.D.C., 2D6 M.D. or 4D6 M.D. per shot.

Rate of Fire: Aimed, burst, wild; see Modern Weapon Proficiencies.

Effective Range: 2000 feet (610 m)

Payload: 20 blasts from a short E-Clip or 30 from a FSE Clip.

Market Cost: 26,000 credits for the rifle. Good availability.

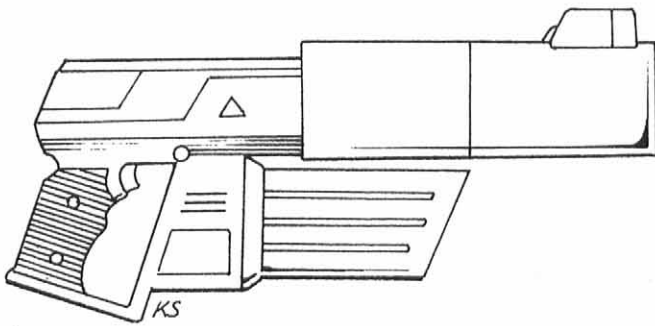

TX-45 Particle Beam Rifle

The TX-45 comes with the standard forward sliding energy clip, but can also use a short clip fitted into its handle. The amount of energy used by each particle beam charge limits the payload more than for any other weapon.

Weight: 9 lbs (4 kg)

Mega-Damage: 5D6 + 6 M.D. per shot

Rate of Fire: Standard, see Modern Weapon Proficiency Section.

Effective Range: 1200 feet (365 m)

Payload: 20 shots from an FSE-clip or 8 from a short clip.

Market Cost: 35,000 credits. Poor to fair availability.

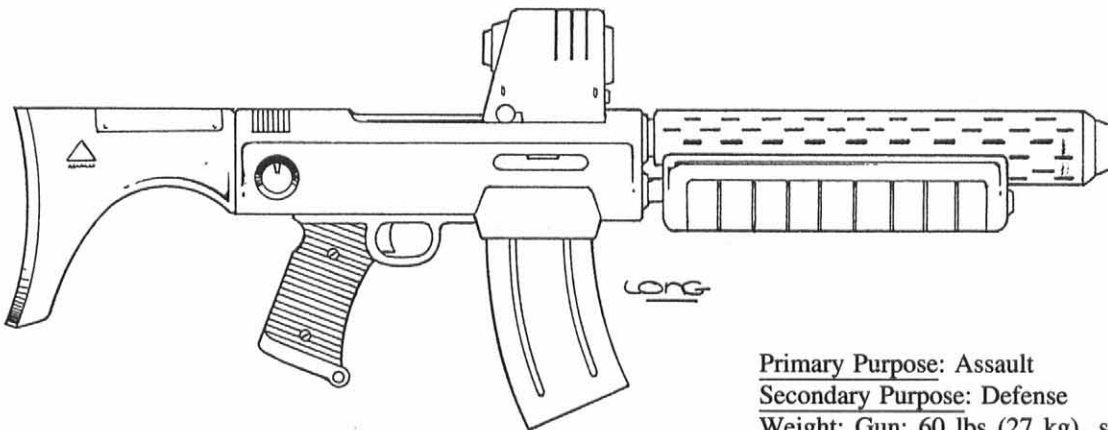

TX-50 Rail Gun

This is a light, all-purpose weapon used by human troops wearing T-11 Enhanced body armor or power armor, as well as cyborgs, human-sized bots, and characters with a strength of 24 or greater. The TX-50 rail gun can use what is called a short clip with 200 rounds (10 bursts), light drum with 600 rounds (30 bursts), or a heavy belt feed drum containing 2000 round (100 bursts). The latter is typically reserved for robots and cyborgs.

Primary Purpose: Assault

Secondary Purpose: Defense

Weight: Gun: 60 lbs (27 kg), short clip: 10 pounds (4.5 kg), light ammo-drum: 30 pounds (13 kg) or a heavy ammo-drum: 100 lbs (45 kg). Ammo-drums are hooked to the back of body armor or a housing on the back of bots.

Mega-Damage: A full damage burst fires 20 rounds and inflicts 4D6 M.D.; a single round does 1D4 M.D.

Rate of Fire: Equal to the character's hand to hand attacks per melee round (usually 3 to 6).

Maximum Effective Range: 4000 feet (1200 m)

Payload: The short clip holds 200 rounds and is capable of firing ten full damage bursts (20 rounds).

The light drum holds 600 round and can fire 30 bursts.

The 2000 round drum is capable of firing 100 full damage bursts (20 rounds each).

Reloading a drum will take about three minutes for those not trained, but a mere 30 seconds by a capable field mechanic. A strength of 24 or higher is required to handle the drum.

Special TX-50 Feature: The TX-50 rail gun for human troops has its own laser targeting/distancing and telescopic sight and nightvision scope. Telescopic and laser targeting range is 6000 feet (1828 m). Bonus: +1 to strike.

Black Market Cost: 50,000 credits. Poor to fair availability.

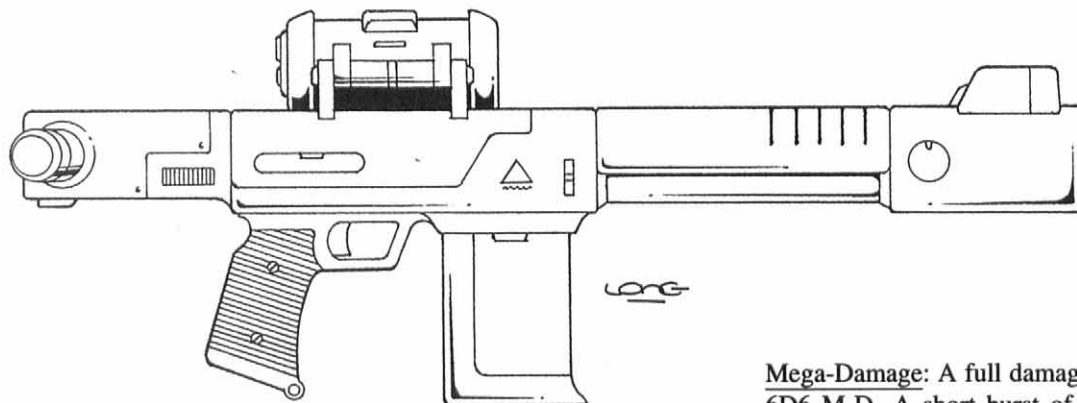

TX-250 Rail Gun

This is the standard weapon for the X-535 Hunter/Jager but can also be used by other power armor units, bots and cyborgs with a strength of 28 or greater. The weapon is light enough that the 12 foot (3.6 m) Jager can use one in each hand, if so desired.

The TX-250 rail gun can use what is called a short clip with 300 rounds (10 bursts) or a belt feed drum containing 3000 rounds (100 bursts). One of the unique features of the TX-250 is that it has three damage settings. It can fire one bullet, a 15 round short burst, or a maximum damage burst of 30 rounds. Few rail guns are as versatile.

Primary Purpose: Assault

Secondary Purpose: Defense

Weight: Gun: 250 lbs (112.5 kg), One TX-250 Ammo-Drum is another 250 lbs (112 kg). The ammo-drum hooks to the back of the bot.

Mega-Damage: A full damage burst fires 30 rounds and inflicts 6D6 M.D. A short burst of 15 rounds does 3D6 M.D. and a single round does 1D4 M.D.

Rate of Fire: Equal to number of combined hand to hand attacks (usually 4-8).

Maximum Effective Range: 6000 feet (1828 m)

Payload: The short clip holds 300 rounds and is capable of firing 10 full damage bursts (30 rounds) or 20 half damage short bursts (15 rounds).

The 3000 round drum is capable of firing 100 full damage bursts or 200 half damage bursts (15 rounds). Reloading a drum will take about three minutes for those not trained, but a mere one minute by somebody trained in the use of power armor. A strength of 28 or higher is required to handle the drum.

Special TX-250 Feature: The rail gun is has its own laser targeting and radar tracking system built into the weapon itself (the large round cylinder). This can be especially useful if the bot's sensor head is destroyed. Range: 6000 feet (1828 m). Bonuses: +1 to strike, +1 to parry and dodge.

Black Market Cost: 75,000 credits. Poor availability.

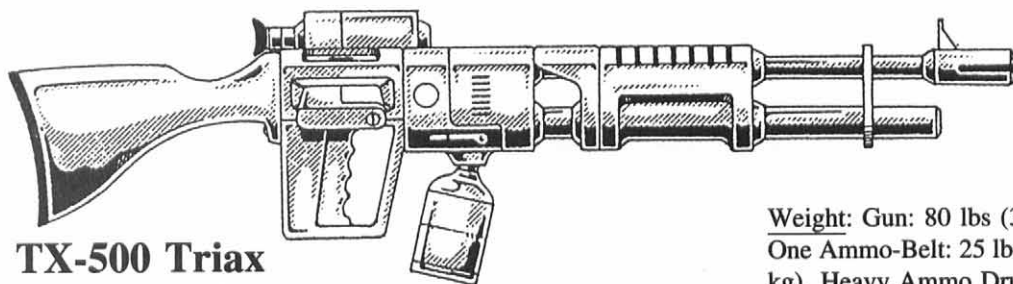

TX-500 Triax Borg Rail Gun

This rail gun is a comparatively, light, portable weapon designed for use by borgs and other creatures with a strength of 24 (or higher) and a high physical endurance (or be made of steel and hydraulics). It can also be used as a machinegun, mounted on a tripod or vehicle. The TX-500 comes equipped with a telescopic, nightvision scope and laser targeting system (+1 to strike).

Weight: Gun: 80 lbs (36.3 kg), Power Pack: 50 lbs (22.7 kg), One Ammo-Belt: 25 lbs (11 kg), Case of six belts: 150 lbs (67.5 kg). Heavy Ammo Drum: 80 lbs (36.3 kg).

Mega-Damage: A Burst is 30 rounds and inflicts 6D6 M.D., one round does 1D4 M.D. A half burst (15 rounds) inflicts 3D6 M.D. DU-rounds add 2D6 to a full burst or 1D6 to a half burst.

Rate of Fire: Standard, see Modern Weapon Proficiency Section.

Maximum Effective Range: 4000 feet (1200 m)

Payload: Heavy Ammo Drum 1170 rounds (39 full bursts); 390 round belt (13 full 6D6 bursts). Or can be fitted with the mini-clip which contains 90 rounds (3 full bursts). Each mini-clip weighs

10 lbs (4.5 kg). Note: The weight of the mini-clip listed in early printings of RIFTS: Sourcebook One was in error.
Black Market Cost: 85,000 credits. Fair availability.

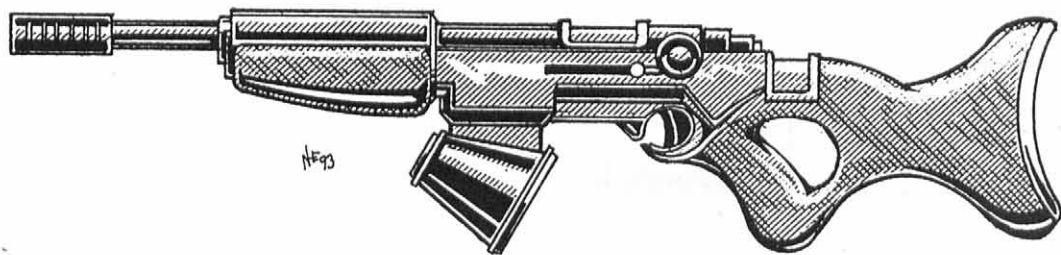

WR-15 Wilderness Laser Rifle

A popular frontier weapon with a unique, drum style E-clip. It is a dependable weapon. The front loaded drum E-clip makes the rifle unbalanced when fired with one hand (-2 to strike, but is +1 to strike when braced by two hands).

Weight: 9 lbs (4 kg)
Mega-Damage: 3D6 M.D. per single shot.
Rate of Fire: Standard, see Modern Weapon Proficiency Section.
Maximum Effective Range: 1600 feet (488 m)
Payload: 40 shots per energy drum.
Market Cost: 18,000 credits. Excellent availability.

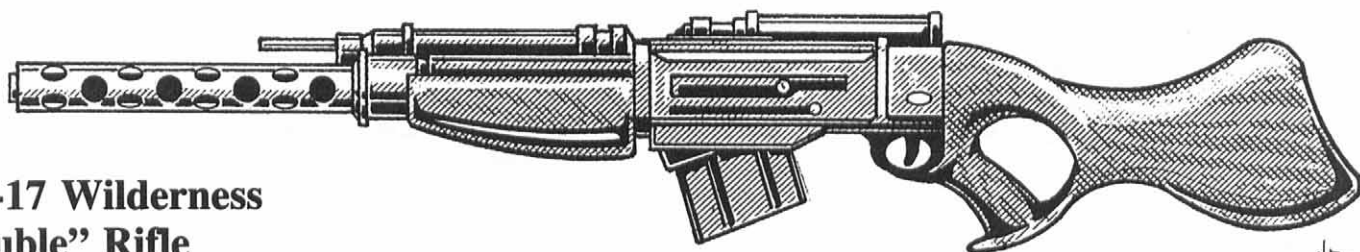

WR-17 Wilderness "Double" Rifle

Another popular frontier weapon. This weapon has two barrels with two different firing capabilities, a heavy ion gun and a light laser (short range for a rifle).

Weight: 12 lbs (5.4 kg)
Mega-Damage: Ion: Two settings: 3D6 M.D. or 4D6 M.D. per single shot.
Mega-Damage: Laser: One setting: 2D6 M.D.
Note: If the target is within range (1200 ft/365 m maximum),

both the laser and ion beams can be fired simultaneously inflicting 5D6 M.D.
Rate of Fire: Standard, see Modern Weapon Proficiency Section.
Maximum Effective Range: Ion: 1600 feet (488 m)
Maximum Effective Range: Light Laser: 1200 feet (365 m)
Payload: 20 shot "short" E-Clip
Market Cost: 24,000 credits. Excellent availability.

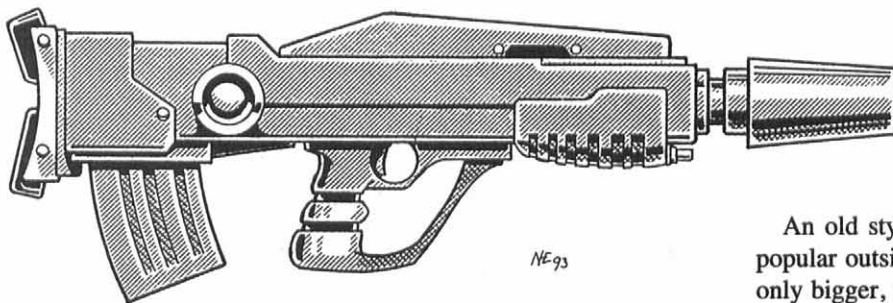

WR-19 (human size) and WR-20 (giant size) Plasma Ejector

An old style energy weapon that continues to be reasonably popular outside the NGR. The giant version has the same stats, only bigger, and is a favorite among the gurgoyles, brodkil and other giant, humanoid monsters.
Weight: 14 lbs (6.4 kg) human size, or 25 lbs (11 kg) giant size.
Mega-Damage: 5D6 M.D. per single shot.
Rate of Fire: Standard, see Modern Weapon Proficiency Section.
Maximum Effective Range: 1600 feet (488 m)
Payload: 10 shot "short" E-Clip
Market Cost: 28,000 credits. Fair to good availability.

Explosives

TX-10 Mini-Missile Launcher

A portable, reusable mini-missile launcher that resembles the 20th Century bazooka. The launcher comes equipped with a multi-optic scope. The capabilities of the scope include telescopic ($\times 10$ magnification, 2 mile/3.2 km range), infra-red (2000 foot/610 m range), passive night vision (2000 ft), and laser targeting.

Weight: The launcher weighs 14 lbs. (6.3 kg), each missile weighs about two pounds (0.90 kg).

Mega-Damage: Any mini-missile can be used, but armor piercing or plasma (1D4 \times 10 or 1D6 \times 10 M.D.C.) are the most commonly used.

Rate of Fire: The weapon can only fire one mini-missile, but a two-man team can load and fire three missiles per melee/15 seconds. A single operator can only fire one per melee round.

Effective Range: One mile.

Payload: One per launcher. A carrying case can hold six mini-missiles (weighs about 12 pounds/5.4 kg), a backpack can hold 12 missiles and a portable carrying case (10 M.D.C.) can hold 24 mini-missiles (weighs about 48 lbs/21.6 kg).

Black Market Cost: 18,000 for the launcher and 2000 credits for each light damage missile (5D6 M.D.) and 3500 for each plasma or armor piercing.

TX-M4 Mini-Missile Launch Pack

A portable mini-missile launcher contained in a backpack. The unit usually has a pocket-size control pad as well as a launch pad in the launch unit itself. The launcher holds four mini-missiles, but can be easily reloaded within approximately 1D4 melee rounds (15 to 60 seconds). With practice, a character can reload all four missiles within 15 to 30 seconds every time.

Primary Purpose: Anti-Aircraft

Secondary Purpose: Anti-Personnel

Missile Type: Any mini-missile can be used, but standard issue is armor piercing (1D4 \times 10 M.D.) or plasma (1D6 \times 10). Fragmentation, stun and/or tear gas may be used for anti-personnel operations.

Missile Weight: A typical mini-missile weighs about two pounds (0.9 kg).

Launcher Weight: 30 pounds (13.6 kg) empty — 38 pounds (17 kg) loaded.

Mega-Damage: Varies with missile type.

Range: Usually about a mile.

Rate of Fire: One at a time, or in a volley of two, or four.

Payload: 4 total.

Cost: 2000 credits for light missiles, 3500 for plasma or armor piercing.

Robot & Cyborg Mini-Missile Systems

There are a variety of mini-missile launch systems available to robots, power armors and cyborgs. Usually, a specific type of launch system is designed for a particular bot or borg and is not subject to change (especially in the military). Those without a missile system cannot usually acquire one other than the portable launchers previously described.

Fusion Blocks

A fusion block is a little square case about the size of a hand-held computer. On top of the block is a small key pad for programming the time of detonation. An automatic 30 second delay is built into each fusion bomb as a safety feature to avoid instant detonation.

Mega-Damage: There are three types of fusion block bombs.

1) 1D4 \times 10 M.D., 2) 2D6 \times 10 M.D., 3) 4D6 \times 10 M.D. (blast radius is a contained 10 foot area (3 m)).

Range: The blocks are made for placement, not throwing or shooting, however one can try throwing the explosive, typical range is 1D6 \times 10 feet (3 to 18 m); fusion blocks are not aerodynamic.

Black Market Cost: 1000, 3000, and 8000 credits respectively.

Typical Triax Hand Grenades

A hand grenade is a small, softball-sized explosive canister designed for throwing and exploding. Average effective throwing range is about 100 feet (30.5 m). **Note:** Grenades are more common, less expensive and easier to acquire than in the Coalition States.

Fragmentation Grenade (anti-personnel): Light: 2D6 M.D. to everything in the blast radius of 20 feet (6 m). **Cost:** 200 credits each. Heavy: 3D6 M.D. to everything in the blast radius of 30 feet (9 m). **Cost:** 250 credits each.

High Explosive Grenade (anti-armor): 4D6 M.D. to a 6 foot (1.8 m) area. **Cost:** 150 credits.

Plasma Grenade: 5D6 M.D. to a 12 foot (3.6 m) area. **Cost:** 350 credits.

Stun/Flash Grenade: This riot/anti-terrorists weapon is designed to disorient and confuse criminals who are holding hostages in confined places. The grenade makes a loud exploding boom and emits a bright flash, followed by a shower of white-hot sparkettes and some white smoke. The flash, burning sparks, and smoke should blind and startle any character without environmental armor or protective goggles. The victims of a stun/flash grenade are -8 to strike, parry and dodge, -1 on initiative and lose one melee attack/action for the next 1D4 melee rounds (15 to 60 seconds). Even those in armor should be momentarily distracted for 1D4 seconds and lose initiative. **Cost:** 100 credits.

Tear Gas Grenades: The gas will instantly affect all characters without protective masks or environmental body armor. The eyes burn, sting and water profusely, causing great discomfort and makes seeing clearly impossible. The gas also makes breathing difficult and irritates exposed skin. The effects last for 3D4 minutes. The 25 foot (7.6 m) cloud dissipates in about five

minutes unless blown away by wind (dissipating more quickly in 1D4 minutes). The victims of tear gas are -10 to strike, parry and dodge, -3 on initiative and lose one melee attack/action for each of the next 1D6 + 1 melee rounds. Those in environmental armor are completely safe and not affected. Cost: 200 credits.

Smoke Grenades release a thick cloud of smoke that covers a 20 to 40 foot (6 to 12 m) radius. The smoke obscures vision in and through the cloud from those on the outside of it. Infrared cannot penetrate a smoke cloud or be used inside a smoke cloud. Those inside the cloud will be blinded and have trouble breathing while inside it. Those who are not protected by environmental suits or gas mask and goggles will be -5 to strike, parry and dodge and -1 on initiative. Attackers firing into/through the cloud are shooting wild. Note that passive nightscopes will work in a smoke cloud. Cost: 50 credits.

Handheld Flare: This is the type of item truck drivers and road patrols use to signal for help or to warn others of an accident or danger. The flare burns for 20 minutes. Cost: One credit each.

Parachute Flares: This pyrotechnic device usually comes in a handheld, throw-away launch tube. Three seconds after launching the flare, it ignites into a bright, sparking light that slowly drifts back down to earth. While in the air, the flare burns for 60 seconds and illuminates an area roughly 150 feet (45.7 m) in diameter. Cost: 10 credits each. Note: This is NOT a weapon, but if shot into a person, the flare does 6D6 S.D.C. each melee round for one minute (four rounds). There is also a 50% chance of causing combustibles to catch fire.

Other Types of Weapons

Vibro-Blades

All vibro-blades are blade weapons surrounded by an invisible, high-frequency energy field that gives them mega-damage capabilities. They were originally developed by the Coalition States and "knocked-off" (imitated) by Triax and other weapon manufacturers. They are popular among soldiers, mercenaries, city rats, adventurers and bandits (the brodkil love 'em too).

Vibro-Knife: 1D6 M.D.

Vibro-Saber (short sword): 2D4 M.D.

Vibro-Sword (larger, one handed sword): 2D6 M.D.

Vibro-Sword for Bots (giant size): 3D6 M.D. to 4D6 M.D.

Vibro-Claws: 2D6 M.D., usually three hooked blades attached to a forearm gauntlet or protective plate. Great for parrying and slashing.

Note: The ancient weapon proficiency skills and bonuses apply to the vibro-blades. Claws fall into the W.P. Knife category.

Neural Mace

Another close combat weapon developed by the CS and adopted by the NGR is the neural mace. The mace is effectively a stun weapon that releases an energy charge that temporarily short-circuits the nervous system. There is a chance of rendering an unarmored person unconscious, but even if the individual remains conscious the charge will impair his movement.

Physical damage from the mace is 1D8 S.D.C. plus P.S. attribute bonus. However, the mace is an M.D.C. structure and can be used to parry M.D. attacks from robots and power armor.

Stun Penalties of the Victim: -8 to strike, parry, and dodge for 2D4 melees. The duration of the impairment is increased 2D4 melees for every hit by the mace (also roll each time to see if knocked unconscious).

Save vs Neural Mace is the same as saving against non-lethal poison, 16 or higher. The character must save each time he or she is struck.

Note: The mace is ineffective against environmental M.D.C. body and power armor, but is effective against Dog Pack armor and half suits, or body armor without a helmet (not fully environmental without the helmet attached).

Electro-Mace (giant)

The electro-mace is a giant, hand-held weapon that can be used as a pounding blunt weapon, or to fire a bolt of energy, by giant robots (typically 20 ft/6 m tall or bigger). The weapon has a sheathing to protect the hand and forearm of the bot and has its own power supply. This weapon is especially useful against monsters that are vulnerable to electricity. It was specifically designed for the X-2500 Black Knight.

Primary Purpose: Anti-Personnel

Mega-Damage: 1) As a blunt, pounding weapon in the hands of the Black Knight, it inflicts 4D6 M.D. per strike.

2) The mace can also be electrically charged so that one's opponent is shocked every time the mace strikes. Add 10 M.D. to blunt, pounding attacks.

3) Alternatively, the mace can fire up to three powerful electrical blasts inflicting 1D4 x 10 M.D. each.

Maximum Effective Range: The electrical blast has a maximum range of 1000 feet (305 m).

Rate of Fire: Equal to number of combined hand to hand attacks (usually 4-8). The electrical blast can only be fired three times per melee.

Payload: Effectively unlimited.

High-tech Arrowheads

Bow and arrows are popular among gypsies, wilderness scouts, adventurers, bandits, and many of the monster races. The bow and arrow have the advantages of not needing an artificial energy supply, being lightweight, silent, and are extremely accurate in skilled hands. Furthermore, the same weapon can fire S.D.C., M.D. or magic projectiles.

Types of Arrowheads: All are suitable for either crossbow or conventional bow and arrows.

Light Explosive: 1D6 x 10 S.D.C.; costs 100 credits each.

Medium Explosive: 1D6 M.D.C.; costs 300 credits each.

Heavy Explosive: 2D6 M.D.C.; costs 550 credits each

High Explosive: 3D6 M.D.C.; costs 900 credits each

Gas: Arrowhead shatters on impact, releasing a toxic gas that fills a ten (10) foot area (3 m). Tear gas costs 100 credits, tranquilizer gas (sleep/knockout for 1D6 minutes) costs 250 credits, paralysis gas (a nerve toxin, causing temporary paralysis for 1D6 minutes) costs 400 credits each. Everybody in the gaseous area must roll to save versus harmful drugs (15 or higher).

Smoke: No damage; creates a smoke screen covering a 20 ft (6 m) area. Cost: 60 credits each; come in four colors, yellow, red, grey and black.

Flare: Emits a bright, sparking light; burns for 60 seconds. Cost: 10 credits each.

Neural Disrupter: Works like a one-shot neural mace. Cost: 400 credits each; rechargeable and reusable 1D6 times before breaking. Inflicts no other damage.

Tracer Bug: Transmits a radio signal that can be followed up to 8 miles (12.8 km) away. Battery powered with a limited life of 72 hours of constant transmission. Arrow must stick into the target or fall on top of the object (without falling off). There is always a chance that the tracer bug arrow will become dislodged and fall off (roll once for every half hour; 1-32% chance). Cost: 200 credits each. Inflicts normal S.D.C. arrow damage.

Magic: The availability and cost of magic or techno-wizard bows and arrows varies dramatically. The most, comparatively common arrows are lightning and fire ball. Cost: 800 to 8,000 credits.

Basic Types of Bows

Weight: Average 2 to 5 lbs (0.9 to 2.3 kg)

Damage: Varies with type of weapon and arrowhead. See the **Rifts RPG**, page 32, W.P. Archery & Targeting for S.D.C. damage and effective ranges.

Rate of Fire: 2 to 8; see W.P. Archery & Targeting.

Effective Range: Varies with bow type; maximum is 700 ft (213 m)

Black Market Cost (simpler types available in wilderness towns too): Typical short bow: 200 credits.

Typical long bow: 400 to 600 credits.

Typical modern composite bow: 500 to 1200 credits.

Typical traditional crossbow: 400 to 600 credits.

Typical crossbow pistol: 200 credits. 1D4 S.D.C. damage.

Typical modern crossbow: 600 to 1200 credits.

Note: The *modern* bow weapon is a product of high technology and is typically built out of man-made materials, lightweight (2 or 3 pounds), accurate, and are very durable.

CS & Alien Weapons

A variety of other weapons can also be found in the NGR and throughout Europe. These include Splugorth/Kittani energy weapons and creations from Mindwerks, the Phoenix Empire, and others, as well as magic weapons and items from other dimensions. Even the occasional Wilk's, Northern Gun and Coalition weapon can be encountered. Their availability may slowly increase as trade with the Coalition States increases.

New High-Tech Equipment

Gun Scopes & Optics

All of these optic systems are available as gun scopes for pistols and rifles as well as goggles and binoculars. As many as four different optics can be combined in a single scope (add the cost of each plus 20% to determine the total cost of the complete multi-optic system).

Telescopic Scope: 10× magnification — works like a pair of binoculars or camera lens. Typical range is 2000 to 6000 feet (610 to 1830 m). Cost: 1000 credits.

Cross Hair Sight: Targeting cross hairs for better aim. When the cross hairs are centered over the desired subject the aim is on target. Bonus: Add +1 to strike but only on aimed shots.

This bonus is not applicable when laser targeting is engaged. Cost: 500 credits for an excellent sight.

Infrared Vision: Infrared scopes are ancient technology and inferior to other passive optical enhancements. However, it is inexpensive and therefore popular among city rats, bandits and adventurers down on their luck. The scope emits a narrow beam of infrared light that is invisible to human eyes. However, the light beam is visible to other characters using infrared vision, including most bots, power armor and a number of D-bees! Those who can see the light can avoid it and/or follow it to its source, giving up its user's location. Furthermore, the narrowness of the light beam limits the available viewing area to about seven feet (2.1 m). Cost: 1000 credits. Maximum Range: 2000 feet (610 m).

Laser Targeting: Add +3 to strike on an aimed shot, but only when the laser targeting system is functioning. No bonus if the system is broken or turned off. Cost: 2000 credits. Note: Laser targeting can be used in conjunction with a telescopic sight and/or thermo-imager. Maximum Range: 4000 feet (1200 m).

Light Filters: Simple transparent lens covers designed to filter sunlight and reduce glare. Cost: 25 credits each.

Passive Nightvision: This system amplifies existing *ambient* light to provide vision in darkness. It is also known as a "starlight" scope because it can amplify the light from stars and the moon to see when outdoors. If in absolute darkness such as an underground tunnel, it is rendered useless — it must have some source of ambient light. Cost: 6,000 credits. Maximum Range: 2000 feet (610 m).

Thermo-imager: A thermo-imaging system as goggles has a range equal to normal human sight and does not automatically come with a telescopic feature. However, it can be combined with a telescopic scope. A thermo-imager converts infrared radiation of warm objects into a visible image. The operator can see heat as represented by bands of color and enables him to see in darkness, shadows and through smoke with 20/20 vision. Cost: 12,000 credits. Note: Can be added to a telescopic gun or camera scope (add the cost of the telescopic feature to the total cost). Range: 2000 feet (610 m).

Medical Items

Note: Also see the medical equipment found in the **Rifts RPG**, pages 246-247.

Medical: Palm Bio-Unit: A palm-size biological analyzer. The digital display can indicate body temperature, blood pressure, respiration, and dehydration level simply by inserting the patient's finger into the finger scanner housing. Cost: 150 credits. Widely available.

Medical: Hypodermic Gun: A quick, painless method of giving shots. Most hypodermic guns come with a self-cleaning mechanism that instantly cleans and sterilizes the needle after every use. Cost: 200 credits (drugs not included).

Medical: IROU Internal Robot Oxygen Unit or "Breather": This is the largest of the internal robots although still quite small. The bot resembles a caterpillar, because it is long and narrow and has many tiny legs. It can enter the body through the mouth or a tracheotomy in the esophagus tube. It crawls through the narrow passage with a pair of thin, narrow plastic tubes trailing behind it. As the bot makes its way toward

the lungs it can transmit video images and data about damage to the throat. Once in the lungs, it transmits data and video images of damage and does analysis. A tiny molecular analyzer is used to identify toxins, drugs and foreign agents. Respiration is also monitored. The video pictures enable the doctors to accurately assess problems and determine the most appropriate treatment without surgery. One of the tubes is hooked up to an external device to extract fluids in the lungs and the other supplies oxygen. The Breather can also release a half dozen IRMSS bots to repair small holes and perform minor surgery. Cost: 50,000 credits.

Medical: IRVT Internal Robot Visual Transmitters or "Seekers": This is another nano-bot about the size of a pinhead. It is injected into the vein of a patient and goes travelling through the vein. It is tracked and monitored via a homing device. The bot transmits a more powerful signal and video image of obstructions and damage to the veins and arteries as they are encountered. The bot is used primarily to locate blocked, pinched and damaged arteries, veins, and other internal passageways. Cost: 80,000 credits per unit — disposable (less than 33% can be safely retrieved, thus they harmlessly disintegrate inside the body after about 72 hours).

Medical: RAU Robot Antiseptic Units or "Cleaners": A cleaner is a tiny robot roughly three inches (76 mm) long and one inch (25 mm) in diameter. They are reminiscent of a mechanical beetle that gently crawls along a wound or infected area destroying infection, removing puss and dead flesh, while cleaning the wound and spraying it with antiseptic protein for faster healing. The cleaners are usually sold and dispatched in pairs. Cost: 50,000 credits per pair.

Medical: RSU Robot Sedative Units or "Sleepers": Four tiny robots, each the size of a pinhead, enter the brain and stimulate certain areas to make the patient relax and feel drowsy. The calming effect of these nano-bots causes the patient to breathe slow, even breaths, keeps the pulse rate steady and calm, and helps maintain normal blood pressure. When they are done the bots return to a tiny housing device. Cost: 100,000 credits per set of four.

Medical: Suture Gun: Effectively a staple-like gun that fires staples made of dissolvable sutures. The staples cause little pain or discomfort, leave little scarring and can be used to close a wound at lightning speed. Cost: 100 credits per gun and 10 credits per 5 feet (1.5 m) of suture.

Medical: Suture Tape: A special, antiseptic tape used to hold cuts closed instead of sutures. Cost: 20 credits per 30 foot (9 m) roll.

Micro-scale: A digital pocket scale, about the size of a person's hand or an old transistor radio. It can be hooked to a belt, slipped into a large pocket, sack, purse or a backpack. The scale can weigh up to 200 lbs. (90 kg); digital display. Cost: 120 credits. Widely available.

Miscellaneous Items

Laser Holographic Portable Computer (Triax LHP-1000): This is actually a knock-off of the Wilk's PC-2020 Field Identifier and Holographic Computer. It is a multi-purpose computer about the size of a briefcase. The case is fire-proof, shock-proof and padded with a mega-damage protective housing. Dual

drive system with 4 gigabytes hard drive with 64 megabytes of Random Access Memory (RAM). Uses one inch disks. The lightweight courier style is 5 lbs (2.3 kg), has 12 M.D.C. and comes in matte black, grey, or maroon, or glossy black or silver chrome. The LHP-1000 "Adventurer" is a heavy-duty briefcase that weighs 10 pounds (4.5 kg), has 25 M.D.C. and comes in matte black, grey, green or camouflage.

The most unique features are its holographic projector beam (has a hard plasma screen as back-up) and its "Identifier program." The identifier program can recognize and identify 6000 vehicles and robots, 21,000 animal species (indigenous and known D-Bee life forms), 40,000 insects, and 50,000 plants and fruits. The data display highlights dangerous and friendly life forms, poisonous and edible plant life, and military vehicles. The identification system is activated by typing in data/features of note (1-72% success ratio and accuracy) or by inputting a visual image like video footage, still photographic, or drawing (94% accuracy/success ratio). The computer then creates a rotating, three-dimensional image of the subject along with the corresponding data available. Many species of alien life are unknown so data is limited to the varieties known in Europe and the Americas (the latter was pirated from the Wilk's computer). Knowledge about Atlantis, Africa, and Asia is minimal (about 12%).

If the computer cannot identify the subject it will report either, "Insufficient data: Alien or mutation?," or "Unknown indigenous life," meaning it cannot identify the subject but available data seems to indicate the subject is native to Earth. A complete lack of information on the part of the operator will result in, "Insufficient data. Please elaborate," meaning that the computer simply does not have enough information to make an assessment. Cost: 20,000 credits. Good availability.

PC-3000 Hand-Held Computer: Described on page 247 of *Rifts*. Cost: 4500 credits. Widely available.

Portable Language Translator: Described on page 247 of *Rifts*. Memory holds 21 languages. Cost: 9600 credits. Widely available.

Portable Short-Range Radar System: This is a backpack style radar scanner that can track as many as 20 different targets, estimate speed, trajectory, and direction (65% proficiency). Weight: 15 lbs (6.8 kg), Range: 5 miles (8 km), Cost: 4000 credits.

SPU-5, Sonic Pulsar Unit; Electronic Flea & Insect Repellent: This handy device is suitable for use by animals, intelligent mutant animals, D-bees and even humans. City dwellers don't often have a problem with fleas, ticks, lice, mosquitos and other pesky insects, but wilderness travelers do. Fleas, lice and biting insects are common to many natural habitats and can be a real problem for explorers, but not with the SPU-Sonic Pulsar unit. Collar or belt unit.

The small device is typically about the size of a cigarette lighter and weighs a mere 4 ounces. It generates sound waves inaudible to dogs, cats, and humans, but intolerable to fleas, ticks, lice and many other bothersome insects. The sound waves prevent parasites and bugs from ever jumping on board and chases away those already present. The micro-battery has a life of one year (costs 10 credits and is easy to replace) or the unit can easily tap into most energy backpacks, a vehicle's lighter

or battery, E-clips, and other power sources. Cost: 100 credits for the belt, collar, or necklace variety. 2000 credits as a cybernetic implant. Wide availability in all styles.

New Cybernetic Implants & Augmentation

Eye Augmentation

Macro-eye: A robot-looking eye that enables the character to magnify tiny objects or areas at close range (within three feet/0.9 m) like a microscope! It also comes equipped with a variety of filters. Microscopic magnification ranges from 1× to 30×. It is extremely popular among medical officers and doctors. Cost: 20,000 credits per single eye. A photographic camera (still or video) feature can be added for the additional cost of 20,000 credits. Add 10,000 credits to have a removable eye.

Macro-eye laser: This eye is very similar to the standard macro-eye except that it also has a tiny surgical laser built into it. A targeting beam indicates exactly where the laser will fire before it is engaged. The laser is used exclusively for internal surgery and inflicts little discernable physical damage to external targets (less than one S.D.C. point). It is another favorite of doctors. Microscopic magnification is 1× to 10×. Cost: 80,000 credits for a single eye. Note that a character would seldom get two macro-eyes of any kind.

Multi-system eye socket: This is a special, permanent housing that enables the character to put in and take out different types of eyes as needed or desired. Bio-system eyes do not work in this housing, only mechanical types. A character will seldom have more than one multi-system eye. Cost: 200,000 credits for the multi-system eye socket and 10,000 credits to make each eye interchangeable with the socket.

Third eye: This is a cybernetic eye that is implanted either above a real eye or in the center of the forehead. The mechanical eye can be any of the available artificial eyes, but is typically one of the camera eyes or multi-optic eye. Cost: 350,000 credits.

Penalty: Reduce the character's beauty by 20%.

Sensors

Medical Sensor Hand: This hand is very similar to the one described in the **Rifts RPG** but has a few different features and calibrations. The artificial hand costs 20,000 for a mechanical type or 33,000 for a cosmetically natural looking human hand.

As many as 14 features can be instilled in the hand. Each sensor feature must be purchased separately. Available features are as follows:

Epidermic Analyzer: Molecular analyzers in the sensor hand can identify and measure the amount of salt, sugar and powerful enzymes or chemicals by touching a person's skin and/or perspiration. It can also measure the patient's body temperature by touch (touch for one minute). Cost: 35,000 credits

Pulse & Pressure Detector: By simply squeezing and holding a patient's wrist or finger for a minute, the doctor can accurately measure the character's pulse rate. By squeezing, holding and slowly releasing the wrist, the doctor can also measure the patient's blood pressure. Cost: 25,000 credits.

Stethoscopic Feature (optional): This feature can only be used with one of the ear implants or a universal finger jack and receiver. The doctor can use his hand like a stethoscope, placing it on the patient's chest or back and listen to his heartbeat or breathing. Cost: 10,000 credits.

Standard Clock Calendar: Same as described in the **Rifts RPG**, page 230. Cost: 200 credits.

Standard Heat Sensor Feature: Same as described in the **Rifts RPG**, page 230. Cost: 5000 credits.

Standard Gyro-Compass: Same as described in the **Rifts RPG**, page 230. Cost: 600 credits.

Standard Motion Detector Sensor Feature: Same as described in the **Rifts RPG**, page 230. Cost: 15,000 credits.

Standard Radar Sensor Feature: Same as described in the **Rifts RPG**, page 230. Cost: 2000 credits.

Standard Radiation Sensor Feature: Same as described in the **Rifts RPG**, page 230. Cost: 1200 credits.

Universal Finger Jack: This is a special connector or jack that is built into one of the fingers, allowing the character to plug directly into most sophisticated computers, audio and sensory equipment, radios, video systems, microphones and even conventional items such as CD players. A tiny receiver is inserted into the ear and linked to the hand jack. Cost: 10,000 credits.

Universal Laser Finger Scalpel: One of the fingers is really a laser scalpel used for surgery. Maximum damage is 1D4 S.D.C. points — it is not a mega-damage weapon. Cost: 5000 credits.

Universal Finger Camera: A tiny still camera fits inside the tip of one finger. The camera shoots 48 photos on microfilm and is designed to automatically adjust for low or high light exposures. Cost: 1200 credits.

Bio-Comp self-monitoring system: A nano-implant tied to a tiny computer system monitors, measures and transmits fundamental physiological information about the person it is implanted in. The data is typically displayed on a wristwatch or bracelet style monitor, but can also be displayed, and recorded, on a computer, portable bio-scan or portable laboratory via a finger or headjack.

Data includes pulse rate, blood pressure, body temperature, blood sugar level, respiratory rate and difficulty breathing, and the presence of foreign elements in the blood stream (indicating the presence of drugs or poison). Cost: 2500 credits.

Internal Comp-Calculator: A tiny computerized calculator usually connected to a headjack, ear implant or artificial eye. The computer responds to spoken, radio or computer transmitted mathematical equations. The answer is transmitted through the headjack, ear or eye implant. Cost: Basic math (addition, subtraction, multiplication, division and fractions): 1000 credits. Advanced math (algebra, geometry, and calculus): 5000 credits.

Bionic Weapons & Combat Features

NGR/Triax Weapons: Certain weapons such as mini-missile launchers, and unique weapons and systems are exclusive to the NGR military and are not commonly available on the open market or even the Black Market. See the specific borg descriptions for the descriptions of these items.

Extendible Hydraulic Hands/Arm: Typically only one limb will have an extendible, hydraulic hand. The control mechanism is typically mental or verbal and responds with the speed and flexibility of a normal arm. The arm's reach is typically increased by three to six feet (0.9 to 1.2 m). The extendible hand/arm enables the character to reach into narrow places like storm drains, ventilator shafts, and so on, as well as places normally out of reach, like a high shelf or window ledge. Typical Arm P.S.: 10 to 20, Cost: 150,000 credits.

Laser Beam Eye (1 or 2): Suitable for bots and borgs. Short range. Usually draws its energy from the artificial power source. In the instances where this feature is used, the eye (or eyes) are unusually large or a visor-like implant rather than human-looking eyes. **Note:** The NGR military also has a particle beam version.

Primary Purpose: Assault

Mega-Damage: 2D6 M.D. per single eye blast or 4D6 M.D. per double blast (both eyes fire simultaneously at the same target). A double blast counts as one melee action.

Rate of Fire: Equal to the borg's total number of hand to hand attacks per melee.

Effective Range: 1000 feet (305 m)

Payload: Effectively unlimited.

Bonus: +1 to strike.

Cost: 130,000 credits.

LGL-31 Grapple & Launcher: A launch compartment and housing that looks like a small weapon nozzle fires a collapsible grappling hook and line. A pneumatic winch reels the line back in, helping characters to scale walls and non-metallic surfaces and hitch rides on giant bots and vehicles. The cord is a super thin, super strong wire with a test strength of 2000 pounds (900 kg).

Mega-Damage: None (minimal)

Range: 100 feet (30.5 m) of lightweight cord (retractable).

Market Cost: 5000 credits.

PL-31 Palm Laser Torch: An "immediate" range laser torch built into the base of the palm and wrist of borgs, bots and power armor. The device has the very short range of one foot (0.3 m), because it is intended as a high intensity laser torch tool to cut through armor, locks, and other tough materials. It can also be used for soldering metal and sealing bulkheads.

Primary Purpose: Tactical Anti-Armor tool.

Mega-Damage: 3D6 per single blast or 6D6 per double blast (both hands combined).

Range: One foot (0.3 m)

Rate of Fire: Equal to the number of hand to hand melee actions of the operator.

Payload: Effectively unlimited (typically built into bots, borgs and power armor and draws on the armor's energy supply).

Note: Currently available only to the NGR's T-31 Super Trooper, but can be included in most types of borgs, bots or power armor.

Black Market Cost: 15,000 credits

Psionic Electro-Magnetic Dampers: Brain implants that distort and fog telepathic and other psionic probes. Psychic opponents find it difficult to read the thoughts and emotions of characters with the psionic dampers. Bonuses: +1 to save vs all psionic attacks, +2 to save vs possession, and +1 to save vs magic illusions and mind control.

RVB-31 Concealed Vibro-Blade: A standard vibro-blade short sword is concealed in a housing in one or both of the forearms. The blade is used as both a defensive and offensive weapon. Concealed, retractable vibro-blades are commonly installed in cyborgs, robots and, to a lesser degree, power armor.

Mega-damage: 2D4 M.D. standard, human-sized blade (saber type). The larger, full-size sword is used in eight foot to ten foot borgs and bots and does 2D6 M.D.; some giant-sized armored units, 10 feet and larger, have a big blade that does 3D6 M.D.

Range: Hand to hand combat.

Market Cost: 5000 to 10,000 credits.

Other Cybernetic Implants: See the *Rifts RPG* for additional cybernetic and bionic enhancements, starting on page 230.

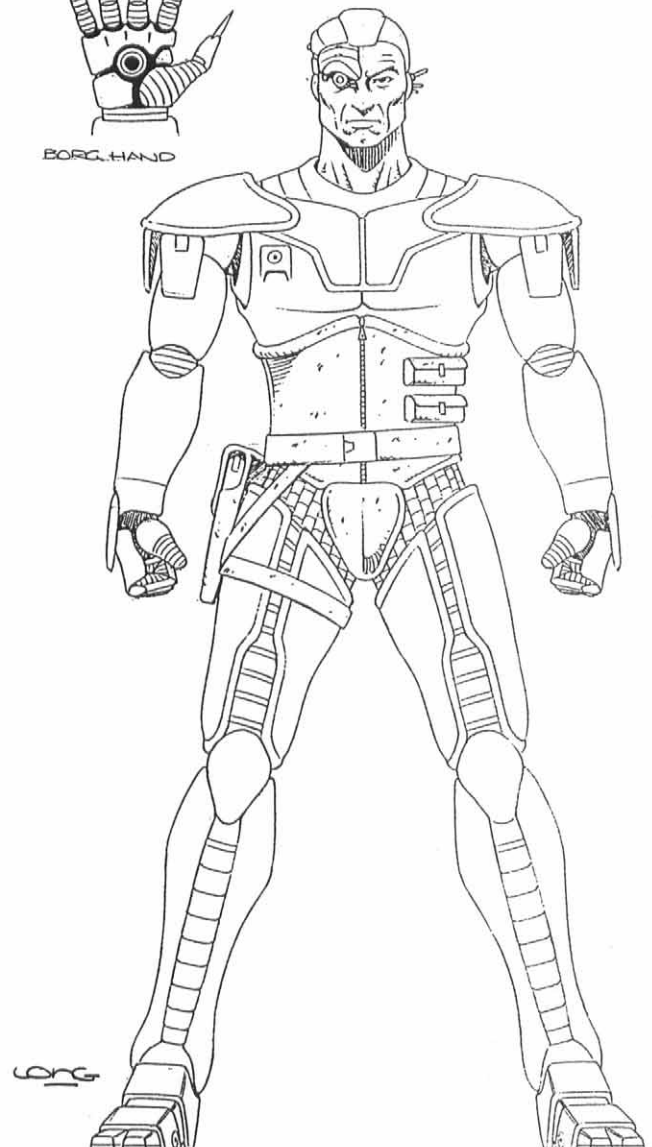

New Skills

Basic Mechanics: A general familiarity and understanding of basic mechanics. This character can fix a toaster, repair a bicycle, replace a belt on a motor, repair or replace a switch, handle or a knob, replace a spark plug, change oil, assist in automobile repairs, maintain machinery, read a schematic and similar fundamental tasks. **Base Skill:** 30% + 5% per level of experience.

Streetwise — Drugs: The following additional street knowledge can be included as part of the regular streetwise skill or used as an additional rogue skill; G.M.'s choice. If used as a separate skill the **Base Skill** proficiency is 25% + 5% per level of experience.

The streetwise: drugs skill gives the character the ability to recognize characters addicted to drugs, street corner pushers, big time dealers, drug smugglers, juicers, Japes, and undercover agents looking to bust dealers. Similarly, the character has a good idea what drugs cost, how to use them and where to buy them (even if he doesn't use them himself). The character also knows most of the "street names" of common drugs, recognizes the drug when he sees it and knows the general effects and dangers it represents. He can also recognize the symptoms in others and can guess what drug a user may be high on with reasonable accuracy (roll under skill ability).

Horsemanship: Exotic Animals: This skill is basically the same as the original horsemanship skill, except that the character is experienced in riding other types of "tamed" animals. This can include elephants, pegasus, dragonductyls, gryphons, demon hounds, fury beetles, giant insects, Wormwood parasites, and other alien or monstrous beasts trained to be riding animals. Wild, untamed creatures cannot be ridden (except by the likes of the Simvan monster riders). **Base Skill:** 30% + 4% per level of experience.

Note: Characters with the traditional "horsemanship" skill for riding Earth horses and other very horse-like animals can quickly figure out how to ride exotic and alien riding animals, but at a skill penalty of -12% to ride ground/running animals and -14% to ride flying or tree climbing and leaping animals. Similarly, D-bees not familiar with riding the fast and sleek Earth horse are -10% to ride them.

Lore — D-bee: Most D-bees (the slang term for Dimensional Beings) are just alien humanoids from another dimension or planet. To be classified as a D-bee, the creature must be remotely humanoid in appearance, usually a biped, has a human-like intelligence and does not possess supernatural powers. Creatures who are not humanoid in basic shape and have extremely monstrous or demonic appearances and/or powers, are usually considered to be monsters rather than D-bees.

D-bee lore is the general study of alien humanoids. This area of study will include culture shock, common types, common behavioral patterns, the distinction between instinctive predators and social oriented beings, myths and legends.

Specific areas of knowledge include the general habits, behavior, customs, powers and weapons of the most infamous D-bees, including Psi-stalkers, Simvan, Xiticixes, True Atlanteans, Kittani, Altara warriors, temporal raiders, and Kydians (Splugorth Overlords). The D-bee lore skill also includes similar, general information about *common* D-bees living in the geographic area where the skill is being taught; i.e. beings commonly known to live in North America will be known by the CS. Similarly, D-bees in Germany/Europe are known by the NGR, and so on. D-Bee lore is not a science. Consequently, it is *not* always accurate, complete or in depth. See anthropology for an in-depth approach to behavioral science. **Base Skill:** 25% + 5% per level of experience.

Lore — Magic: This area of study does *not* give the character any magic powers or the ability to read magic symbols. What it provides is general information about magic, magic creatures and myths about magic. For example, a character with this skill knows about the general powers and abilities of infamous magic creatures such as the various types of dragons, sphinxes, unicorn, and so on. He'd know what the main types of magic (on Earth or at least his geographic area) are, such as spell casting, summoning, rifting, techno-wizardry, stone magic, temporal magic, bio-wizardry, rune magic, necromancy, and so. Likewise, the character is likely to know legends about powerful magic items, magic places, magic curses and related legends. Although the character cannot read runes or mystic symbols, he is likely to be able to recognize whether the symbol is a real magic ward, rune or warning.

The following abilities come with this layman's skill: **Base Skill (general knowledge):** 25% + 5% per level of experience. **Recognize wards, runes and circles:** 15% + 5% per level of experience. **Recognize Enchantment:** i.e. magic items, people under charms and curses, etc.; 10% + 5% per level of experience.

Language Update: The following additional languages are reasonably common place in Europe: Gargoyle, Brodkil, and Demongogian, a common language among supernatural beings who actually call themselves (or associate with) demons, including the demon hordes of Hades (gargoyles, alu, shedims, baal-rogs, jinns, raksashas, etc.), the denizens of Dyval (deevils, fiends, fenry, etc.) and the minions of Wormwood.

W.P. Battle Axe: Training in all types of battle axes and picks. **Bonuses:** +1 to strike at levels one, four, eight, and twelve. +1 to parry at levels two, five, nine and thirteen. +1 to strike when thrown at level three, eight and twelve.

W.P. Polearm: Training in the large spear-like weapons known as the polearm. Also includes tridents. **Bonuses:** +1 to strike at levels one, five, nine, and fourteen. +1 to parry at levels one, three, six, nine and twelve. +1 to strike when thrown at level two, five, nine and fourteen.

Occupational Character Classes

Army (Infantry Soldiers)

Infantry Soldier O.C.C.
Communications Officer O.C.C.
Medic/Medical Officer O.C.C.

Armored Division

Cyborg Soldier O.C.C.
Field Mechanic O.C.C.
Power Armor Commando O.C.C.
Robot Combat Pilot O.C.C.
Robot Soldier O.C.C. (optional)

Intelligence Division

Intelligence Officer O.C.C.
Intelligence Commando O.C.C.
Police Enforcement (Civil & Military Enforcement)

Other O.C.C.s of Note

Euro-Juicer O.C.C.
Gypsy Thief O.C.C.
Gypsy Wizard Thief O.C.C.
Gypsy Seer O.C.C.
Gypsy —The Gifted (healer) O.C.C.
Available O.C.C.s from Rifts

O.C.C.s from the Rifts RPG

Except for a few exceptions, most of the O.C.C.s and R.C.C.s found in the **Rifts RPG** and North America, also exist in the New German Republic and Europe. There are even a handful of Coalition State military O.C.C.s lured to Europe by the potential alliance. The most common and notable O.C.C.s and R.C.C.s in Europe include:

Borgs	Mind Melters
Crazies	Operators
City Rats	Psi-Stalkers
Cyber-Docs	Rogue Scholars
Dragons	Shifters
Juicers	Techno-Wizards
Headhunters	Vagabonds
Line Walkers	Wilderness Scouts

A wealth of O.C.C.s, characters, monsters and equipment found in the pages of **Rifts World Books: Atlantis, England & Africa** are also appropriate for campaigns in Europe, the Middle East and parts of Asia.

Military O.C.C.s

The soldiers of the New German Republic are well trained in both combat and mainstream areas of expertise. While the emphasis of the training may be on the needs of the military and combat situations, the soldier will find that many of his skills will translate well into the industrial world of the NGR. Communication engineers, computer experts, mechanics, doctors, and pilots are regarded as highly skilled and desirable technicians.

The NGR Army

An important note about military O.C.C.s: A character can be an active member of the military or he/she can be retired or discharged from active duty. Retired or ex-soldiers can continue to use their military skills as independent operatives such as freelance fighters, mercenaries, strike & rescue teams, civilian security operatives, surveillance team/private investigators, or adventurers. The advantage to being an "independent" operative is that (at least theoretically) the character is his own boss and can act on his own morals, judgements and desires. On the negative side, freelancers will have to purchase their own weapons, armor and equipment.

The only O.C.C. adjustment for ex-military personnel is that the character gains experience at a slower rate. The day the character leaves the military, he needs 25% more experience points to reach each subsequent level of experience in his chosen military O.C.C. **For example:** If the soldier normally needs 8,801 points to reach the next experience level, the ex-soldier must get 2200 more points (an additional 25%), for a total of 11,001 experience points, to reach that next stratum of experience and expertise.

The active soldier progresses in experience at the normal rate (see the experience tables at the back of the book). Active soldiers must follow orders and answer to military authority and military law. They cannot defy orders without an excellent cause and may still be court-martialed, imprisoned or dishonorably discharged from military service (losing all military benefits).

The majority (60%) of German citizens will have military occupations or combat experience because of the battles that rage on between the humans of the New German Republic and the marauding monsters who surround them.

Infantry Soldier O.C.C.

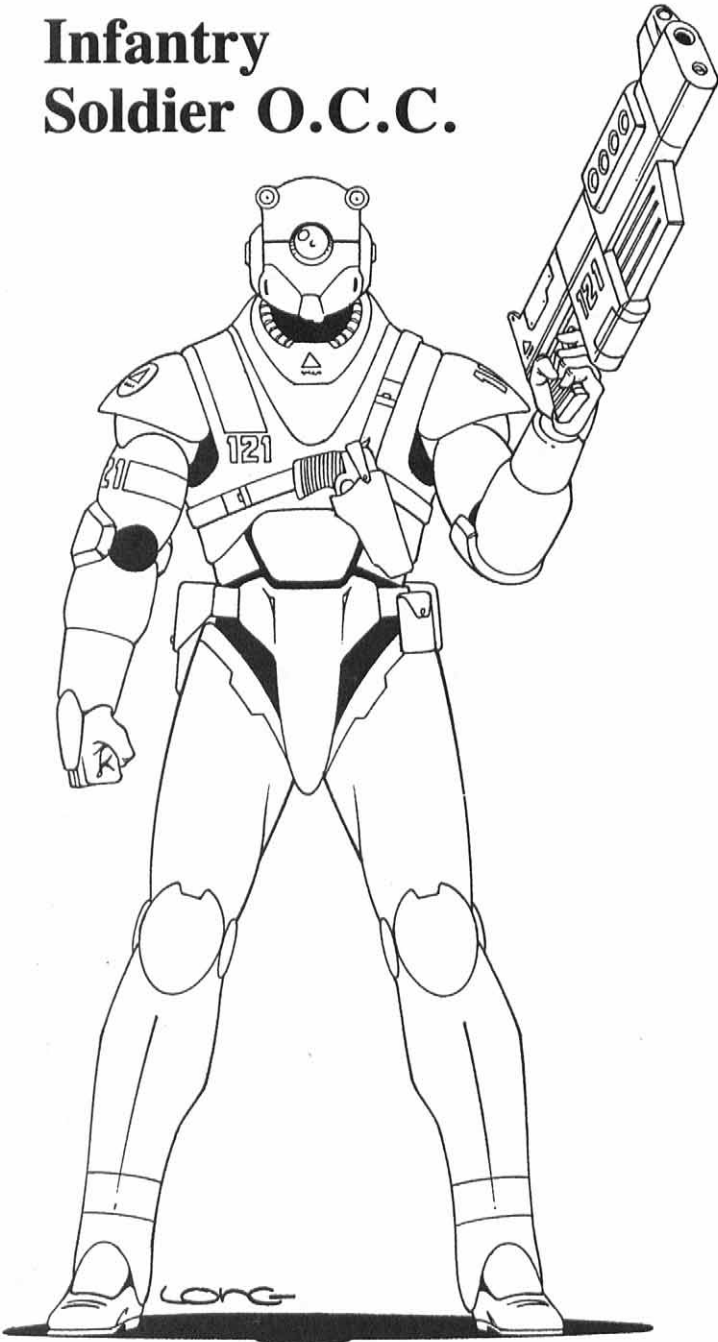

The infantry soldier is a typical infantryman, the grunt of the army, the unsung hero. The soldier is taught the basics of combat and related skills such as basic radio communication, piloting tanks, using a weapon and self defense. The soldier is one of the few military O.C.C.s that is not trained in the operation of power armor or robots, however, they can be assigned as a crew member of a robot vehicle, or assigned as a pilot or gunner in a tank, APC, or hover vehicle.

Fifty percent of the active infantry soldiers are human refugees from outside the NGR (Poland, Hungary, etc). Many of the refugees (75%) will become career soldiers and half will meet their end on the field of combat.

Attribute Requirements: A high I.Q., P.S. and P.E. are helpful but not a requirement. Any human with the spirit to fight and who is in good health can become a soldier.

O.C.C. Skills:

Math: Basic (+10%)
 Literacy: Euro (+10%)
 Language: Euro (+20%)
 Radio: Basic (+10%)
 Computer Operation (+10%)
 Pilot skill of choice (+20%)
 Pilot Tanks & APCs (+20%)
 Pilot Truck (+15%)
 Wilderness Survival (+10%)
 General Athletics
 Climbing (+10%)
 Swimming (+10%)
 Running
 W.P. Automatic Rifle
 W.P. Energy Rifle
 Hand to Hand: Basic

Hand to hand: basic can be changed to expert for the cost of one "other" skill. To change to martial artist (or assassin if evil), the cost is two "other" skill selections.

O.C.C. Related Skills: Select six "other" skills, plus select one additional skill at levels four, eight, and twelve. All new skills start at level one proficiency.

Communications: Any (+10%)
 Domestic: Any
 Electrical: Basic electronics only
 Espionage: Sniper only.
 Mechanical: Basic mechanics only
 Medical: First aid only (+10%)
 Military: Any (+10%)
 Physical: Any
 Pilot: Any (+10%)
 Pilot Related: Any (+10%)
 Rogue: Any (+5%)
 Science: None
 Technical: Any (+10%)
 W.P.: Any
 Wilderness: Any (+5%)

Secondary Skills: The character also gets to select two secondary skills from the list, excluding those marked "None," at levels two, four, seven, ten and thirteen. These are additional areas of knowledge that do not get the advantage of the bonus listed in parentheses. All secondary skills start at the base skill level.

Standard Military issue for Combat Soldiers: T-10 body armor, T-42 energy rifle, four extra E-clips, 2 smoke grenades, 2 fragmentation grenades (2D6 M.D.), survival knife, flashlight, distancing binoculars, canteen, utility belt, backpack, additional air filter and gas mask, walkie-talkie (when not in armor), two standard uniforms and one dress uniform.

Equipment Available Upon Assignment: Additional equipment and weapons, portable language translator, T-11 Enhanced body armor, T-100 Eagle jet pack, APC, XM-200 mini-tank, access to tanks of all kinds and other vehicles or transportation. The character also has access to most military bases (low security clearance) and military doctors, hospitals and facilities. **Note:** Availability of equipment and resources may be dependent upon the local commander, supply stock, location, casualties and combat conditions. The combat soldier is typically at the bottom of priority lists.

Money: The soldier gets a roof over his head, food, clothing, medical care and all other basic needs provided free as part of his/her pay. The character also receives a monthly salary of 1000 credits (the savings of a first level character is $1D4 \times 1000$ credits). High ranking officers (9th level and higher) get 3000 credits a month.

Soldier's quarters is a nice, dormitory style barracks. Four soldiers share one dormitory area. Each gets a private bedroom and all share one bathroom, a sitting room, and living room area. Other features include a stereo, video system and personal computer. Or the soldier can opt to live off base at his own expense.

Rank: Standard military; private to lieutenant colonel.

Cybernetics and Bionics: None to start, but basic cyber-implants can be purchased or awarded for acts of heroism.

Communications Officer O.C.C.

The communications officer is a combat soldier with specialized training in the areas of communication, television, computers, sound equipment and surveillance. The character not only maintains the vital transmission of information and communications, but is involved in breaking secret codes, scrambling and unscrambling messages, security, reconnaissance, espionage, sabotage (of enemy computers and communication systems) and investigations.

Attribute Requirements: I.Q. 9 or higher; a high M.E. and P.E. are helpful but not a requirement. Anybody with a good head on his shoulders, the spirit to fight and good health can become a communications officer.

O.C.C. Skills:

Math: Basic (+15%)
Literacy: Euro (+20%)
Language: Euro (+30%)
Cryptography (+20%)
Radio: Basic (+20%)
Radio: Scrambler (+20%)
Surveillance Systems (+20%)
Computer Operation (+20%)
Computer Programming (+10%)
Computer Hacking (+10%)
Read Sensory Equipment (+20%)
Pilot skill of choice (+10%)
General Athletics
Climbing (+10%)
Swimming (+10%)
Running
W.P. Energy Rifle
Hand to Hand: Basic

Hand to hand: basic can be changed to expert for the cost of one "other" skill. To change to martial artist (or assassin if evil), the cost is two "other" skill selections.

O.C.C. Related Skills: Select six "other" skills, plus select one additional skill at levels four, eight, and twelve. All new skills start at level one proficiency.

Communications: Any (+20%)

Domestic: Any

Electrical: Basic electronics and computer repair only (+10%)

Espionage: Intelligence and wilderness survival only.

Mechanical: Basic mechanics only

Medical: First aid only (+10%)

Military: None

Physical: Any, except acrobatics.

Pilot: Any (+5%)

Pilot Related: Any (+10%)

Rogue: Any

Science: None

Technical: Any (+10%)

W.P.: Any

Wilderness: Land navigation only (+6%)

Secondary Skills: The character also gets to select two secondary skills from the list, excluding those marked "None," at levels two, four, seven, ten and thirteen. These are additional areas of knowledge that do not get the advantage of the bonus listed in parentheses. All secondary skills start at the base skill level.

Standard Military issue for Communications Officers: T-10 body armor, T-42 energy rifle, four extra E-clips, 2 smoke grenades, 2 fragmentation grenades (2D6 M.D.), long-range directional radio, radio scrambler, hand-held computer, survival knife, flashlight, distancing binoculars, multi-optics band, canteen, utility belt, backpack, additional air filter and gas mask, walkie-talkie (when not in armor), two standard uniforms and one dress uniform.

Equipment Available Upon Assignment: T-11 Enhanced body armor, T-100 Eagle jet pack, hover vehicle or other transportation, additional weapons, cameras, surveillance equipment, broadcasting equipment, portable radar and sensors and other equipment. The character also has access to most military bases (medium security clearance), military broadcasting stations, film and recording studios, editing and duplicating facilities and similar. **Note:** Availability of equipment and resources may be dependent upon the local commander, supply stock, location, casualties and combat conditions. The combat soldier is typically at the bottom of priority lists.

Money: The communications officer gets a roof over his head, food, clothing, medical care and all other basic needs provided free as part of his/her pay. The character also receives a monthly salary of 1500 credits (the savings of a first level character is $1D6 \times 1000$ credits). High ranking officers (9th level and higher) get 3000 to 4000 credits a month.

Soldier's quarters is a nice, dormitory style barracks. Four soldiers share one dormitory area. Each gets a private bedroom and all share one bathroom, a sitting room, and living room area. Other features include a stereo, video system and personal computer. Or the soldier can opt to live off base.

Rank: All communications officers start field duty at a rank of corporal.

Cybernetics and Bionics: Cybernetic language translator and universal headjack and ear implant to start. Others may be purchased or awarded for acts of heroism and performance of duties.

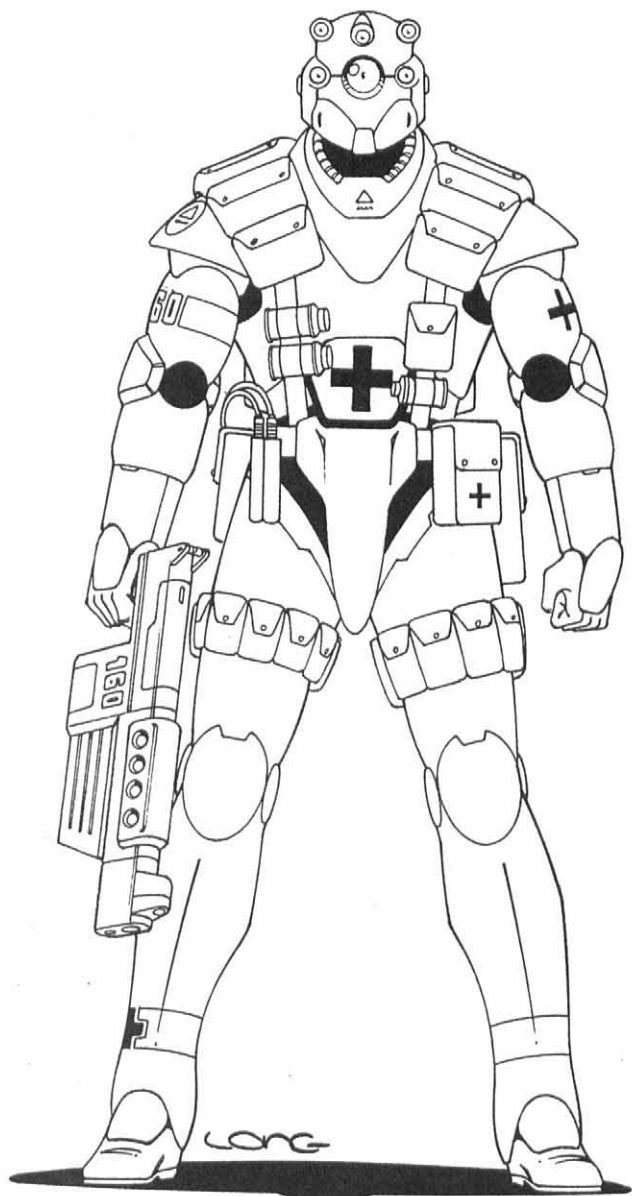

Medic/Medical Officer O.C.C.

The medical officer is roughly equivalent to the Body Fixer O.C.C. except that this character has had basic military training and is a medical doctor in the Armed Forces of the New German Republic. The medical officer O.C.C. is a capable surgeon and healer accustomed to combat conditions and working in make-shift operating rooms. They are tough, resourceful and focused healers dedicated to the preservation of life.

Most medical personnel try to avoid combat and concentrate on saving lives, not taking them. Some medical officers even refuse to wear or use firearms of any kind, under any circumstance. However, all military doctors are trained in the basics of self-defense and the use of energy rifles whether they use them or not. Additionally, most medical officers, all of whom are skilled surgeons, are deadly with a scalpel and knife.

The medical officer and all field medics can use any type of weapon, body armor, or vehicle, but most wear light body armor and tend to travel light, giving priority to medical equipment

over everything else. The medical officer tends to avoid bionics for himself, but is likely to have a handful of cybernetic implants. Most are reasonably familiar with cybernetic implants and prosthetics and are able to remove and install most basic systems. Many even have a very rudimentary understanding of bio-wizard symbiotes (how they work and how they affect the body). Medical officers are very familiar with the use of synthetic skin, bio-system eyes and organs, as well as medical nano-robots. However, on the field of combat, the character's goal is usually to stabilize a patient and medivac the soldier to the nearest hospital for more extensive treatment. The installation of bionics is much more complex and specialized than making simple repairs or surgically installing artificial bio-systems. Consequently, the medical officer is ~20% whenever working on bionic modifications or installation and ~40% when working on extremely alien physiology, bionics, bio-wizard symbiotes/implants or Mindwerks brain implants.

The average medical officer is hardened and grizzled — the result of seeing, up close and incessantly, the horrors of war. Their dislike or hatred of the enemy is due in part to the savagery and viciousness of their foes. Gargoyles, brodkil and most supernatural monsters have little regard for life of any kind. The creatures do not honor any of the laws or morals of humanity. They attack medical evacuation vehicles, hospitals, doctors, nurses, unconscious patients, women, and children. The monsters frequently engage in torture, the murder of unarmed personnel, physical and mental abuse of prisoners, slavery and wanton destruction. This has made even doctors bitter and hostile towards them. Still, most medical personnel are compassionate humanitarians dedicated to healing. They struggle for what they believe in and continue their thankless work to save lives. Of course, each character's personal goals may vary dramatically. Some are driven by the need to help and preserve life, others to restore freedom, while other crave personal glory or profit. The character can be any alignment, good, selfish, or evil.

Some of the older veterans have become indifferent to the suffering of others. They are skilled, even expert surgeons, but have the bedside charm of an iceberg. Some (about 30%) have learned to loathe the gargoyles, gurgoyles, brodkil, gene-splicers, and D-bees in general. These characters are extremely cold and callous toward non-humans. Many of these otherwise humanitarian doctors will turn their backs on the suffering of non-humans with little regret. The most bitter and cruel (about 5%) engage in torture and experimentation on D-bees (torture is far more common than experimentation). In the cases where torture occurs, inevitably the commanding officer(s) condones or even encourages it as a means to extract information or vengeance from enemy prisoners or to evoke fear. It is important to stress that the use of torture is not authorized by the military high command and most medical officers do not participate in its practice.

Rogue Doctors

Most medical officers remain in the army for years. When they finally retire from military service, the majority establish a medical practice for humans in the New German Republic. Some, however, become "body fixers." They are considered irresponsible rogues, or even dangerous criminals, because they offer their expert medical services to anybody who needs them, including undesirables like mutants, D-bees, wilderness peas-

ants, wasteland vagabonds, mercenaries, adventurers, gypsies and men of magic. The doctor's association with these people of questionable character, who may be enemy sympathizers or spies, is a serious crime and frequently judged as an act of treason, punishable by death.

Medical officers who leave the military and turn rogue continue to advance in experience under the Medical Officer O.C.C. without penalty. A player can also select a non-military *body fixer* O.C.C. as a player character as described in the **Rifts RPG**, page 71. This character has never been a soldier anywhere.

Attribute Requirements of the medical officer: I.Q. 10 and M.E. 14 or higher; a high P.P. is ideal but not mandatory.

O.C.C. Skills:

- Medical Doctor (+10%)
- Biology (+30%)
- Pathology (+30%)
- Criminal Science & Forensics (+20%)
- Computer Operation (+20%)
- Chemistry (+10%)
- Chemistry: Analytical (+10%)
- Math: Basic (+20%)
- Math: Advanced (+20%)
- Literacy: Euro (+30%)
- Language: Euro (+30%)
- Language: Select one additional (+20%)
- Pilot Hover Craft (+10%)
- W.P. Knife
- W.P. Energy Rifle
- Hand to Hand: Basic

Hand to hand: basic can be changed to expert (or assassin if evil) for the cost of two "other" skill selections.

O.C.C. Related Skills: Select seven other skills, but at least two must be selected from technical or the sciences. Plus select two additional skills at levels three and six, one at level nine, and one at level twelve. All new skills start at level one proficiency.

- Communications: Radio: basic, radio: scramblers & optics only (+5%)
- Domestic: Any (+10%)
- Electrical: Basic electronics only (+5%)
- Espionage: Wilderness survival only (+10%)
- Mechanical: Automotive only
- Medical: Any (+20%)
- Military: None
- Physical: Any, excluding boxing, wrestling and acrobatics.
- Pilot: Any (+5%), except tanks, APCs, robots and power armor.
- Pilot Related: Any
- Rogue: None
- Science: Any (+10%)
- Technical: Any (+15%)
- W.P.: Any
- Wilderness: Identify plants, land navigation, & preserve food only.

Secondary Skills: The character also gets to select six secondary skills from the list, excluding those marked "None." These are additional areas of knowledge that do not get the advantage of the bonus listed in parentheses (). All secondary skills start at the base skill level.

Note: The medical officer O.C.C. can also function as a field scientist depending on the selection of other skills.

Medical Equipment: Medical harness with its many pouches, two dozen throw-away (paper) surgical gowns, hand-held computer, pocket-size CD audio recorder with 12 three hour discs, an additional laser scalpel, and portable laboratory.

Medical kit with soap, disposable towels, bandages, suture tape, antiseptics, protein healing salve, aspirin, painkillers, antibiotics, sedatives, anesthetic, hypodermic gun, stethoscope, pen flashlight and portable compu-drug dispenser.

Surgical kit includes a variety of scalpels, one laser scalpel, needles, clamps, sutures, suture tape, suture gun, several IRMSS/Internal Robot Micro-Surgeon Systems, RMK/Robot Medical Kit, hand-held blood pressure machine (computerized), 3D4 thermometers, six unbreakable specimen containers, 100 pairs of disposable surgical gloves, two pair of reusable surgical gloves, and other basic items.

Standard Military Equipment: One T-12 medic body armor suit, TX-42 laser rifle and/or sidearm, utility belt, leg belt and pouches, backpack, air filter and gas mask, portable language translator, walkie-talkie, canteen, two smoke grenades, two signal flares, two standard uniforms and two dress uniforms.

Equipment Available Upon Assignment: The one-man XM-50 medical ambulance (a hover vehicle), other medivac vehicles or means of transportation, additional weapons and ammunition, additional medical supplies/equipment and nano-bots, robot assistant, access to medical assistants (nurse, orderly, etc.). They also have access to hospitals, their laboratory facilities, operating rooms, examining equipment, and facilities, access to computers, military escort/protection, food rations, and field equipment. **Note:** The availability of equipment and resources will vary depending on the commander, supply stock, location, number of casualties and combat conditions. The medical officers are usually given priority in getting medical supplies and equipment.

Money: The medical officer gets a roof over his head, food, clothing, access to medical facilities and all other basic needs provided free as part of his/her pay. The doctor also receives a monthly salary of 3000 credits (the savings of a first level character is $2D4 \times 1000$ credits). High ranking officers (9th level and higher) get 4200 credits a month. The pay may sound low, but this character is not concerned with money alone; like most soldiers in the NGR military, they are concerned most with defending their homeland.

When not in the field, the medical officer is given use of a private apartment usually near a hospital or on a military base. The apartment has a private bathroom, tiny kitchenette (with refrigerator and microwave oven), living room, bedroom and a study/library, and comes complete with a stereo and video system and private computer.

Rank: All doctors/medical officers start at the rank of captain.

Cybernetics and Bionics: Select two cybernetic augmentations from any category — usually sensory augmentation. See the **Rifts RPG** and the cybernetic section in this book for the full range of available items. Favorite types of cyber-devices include lung, eye and sensor implants.

NGR Armored Division

Cyborg Soldier O.C.C.

Unlike the Coalition States whose leaders hesitate at officially sanctioning and creating cyborgs as military personnel, Triax and the NGR embrace cybernetic enhancements. In fact, 18% of the NGR troops are full conversion borgs, 15% are partial reconstructed borgs, and 60% of the soldiers have minor cybernetic implants.

A cyborg soldier must be either a partial or full conversion cyborg. All candidates for such conversion are thoroughly evaluated and prepared for life as a living machine. Although there are special operatives, variants and exceptions (use the borg design rules in the **Rifts RPG**), the NGR has several specific cyborg designs used by the military. The descriptions for each can be found in the equipment section dedicated to cyborgs and cybernetic implants.

Attribute Requirements: M.E. 15 or higher, a good I.Q. and M.E. are desirable but not necessary. Any human with the spirit to fight and who is in good mental health can become a cyborg soldier.

O.C.C. Skills:

Math: Basic (+10%)
Literacy: Euro (+10%)
Language: Euro (+20%)
Radio: Basic (+10%)
Computer Operation (+10%)
Pilot skill of choice (+20%)
Pilot Tanks & APCs (+20%)
Wilderness Survival (+10%)
Climbing (+10%)
Swimming (+10%)
S.C.U.B.A. (+10%)
W.P. Automatic Rifle
W.P. Energy Rifle
W.P. Heavy Energy Weapons
Hand to Hand: Basic

Hand to hand: basic can be changed to expert for the cost of one "other" skill. To change to martial artist (or assassin if evil), the character must trade two "other" skill selections.

O.C.C. Related Skills: Select five "other" skills, plus select one additional skill at levels four, eight, and twelve. All new skills start at level one proficiency.

Communications: Any (+10%)
Domestic: Any
Electrical: None
Espionage: None
Mechanical: None
Medical: First aid only (+10%)
Military: Any (+10%)
Physical: Any that are still appropriate.
Pilot: Any (+10%)
Pilot Related: Any (+10%)
Rogue: Any (+5%)
Science: None
Technical: Any (+10%)
W.P.: Any
Wilderness: Any (+10%)

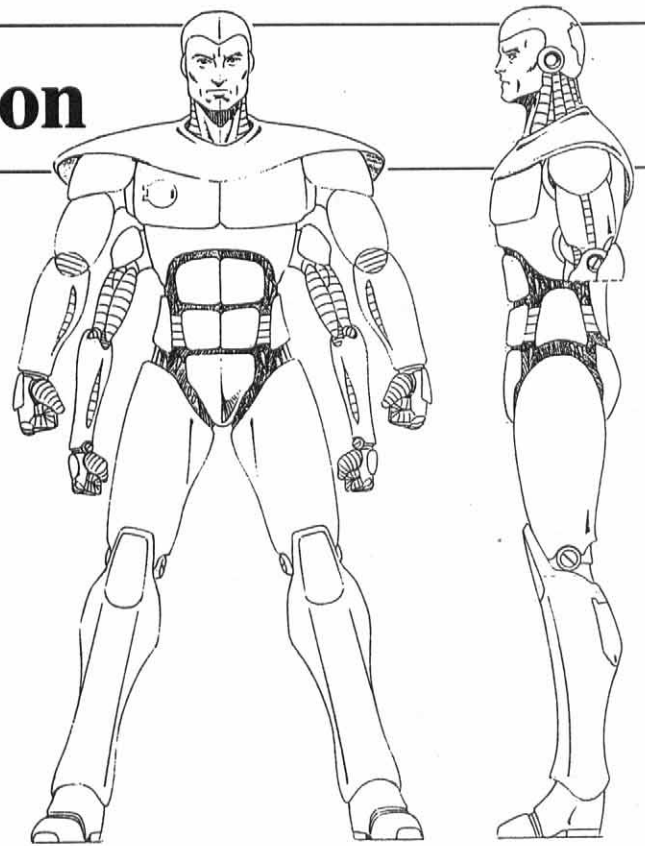

Secondary Skills: The character also gets to select two secondary skills from the list, excluding those marked "None," at levels two, five, eight and thirteen. These are additional areas of knowledge that do not get the advantage of the bonus listed in parentheses. All secondary skills start at the base skill level.

Standard Military issue for Cyborg Soldiers: All the appropriate ammunition and equipment for the borg's body styling and weapon systems. Energy rifle of choice, four extra E-clips, four grenades of choice, distancing binoculars, utility belt, backpack, walkie-talkie (for back-up) and regular maintenance and repairs.

Equipment Available Upon Assignment: T-100 Eagle jet pack, hover vehicle or other transportation, additional weapons, and equipment. The character also has access to most military bases (medium security clearance) and facilities. **Note:** Availability of equipment and resources may be dependent upon the local commander, supply stock, location, casualties and combat conditions.

Money: The soldier gets a roof over his head, food, clothing, medical care and all other basic needs provided free as part of his/her pay. The character also receives a monthly salary of 1800 credits (the savings of a first level character is 1D6 x 1000 credits). High ranking officers (9th level and higher) get 3500 to 5000 credits a month.

Soldier's quarters are a nice, dormitory style barracks. Four soldiers share one dormitory area. Each gets a private bedroom and study with a personal computer, computer games, stereo, and television. All share one bathroom, a sitting room, and living room area. Or the soldier can opt to live off base at his own expense.

Rank: Standard military; private to general.

Bionic Conversion: Any of the cyborgs described in the cybernetics and borg section of this book are available as player characters.

Field Mechanic O.C.C.

The Field Mechanic O.C.C. is a highly regarded specialist in the repair, modification and maintenance of robots, power armor, vehicles and machines in general. They are the life line of the mechanized division and key personnel in an army (and society) that relies so extensively on robots, cybernetics and machines. These brave men and women are regularly in the middle of combat, making repairs or helping to retrieve robots and vehicles. On occasion, they slip behind enemy lines with commandos or a reconnaissance team to examine and assess enemy strengths in regards to armor, or to help break into and/or sabotage enemy systems.

The NGR has even provided the field mechanic with special armor and optics, cybernetics and equipment.

Attribute Requirements: I.Q. 9 or higher; a high P.S. and P.P. are very helpful but not a requirement.

O.C.C. Skills:

- Math: Basic (+20%)
- Math: Advanced (10%)
- Literacy: Euro (+30%)
- Language: Euro (+30%)
- Language: Select one additional (+10%)
- Radio: Basic (+20%)
- Computer Operation (+10%)
- Electrical Engineer (+20%)
- Robot Electronics (+20%)
- Mechanical Engineer (+20%)
- Robot Mechanics (+20%)
- Weapons Engineer (+20%)
- Weapon Systems (+10%)
- Pilot Hover Vehicles (+10%)
- Pilot Robots & Power Armor (+6%)
- Robot Combat: Basic
- Running
- W.P. Energy Rifle
- Hand to Hand: Basic

Hand to hand: basic can be changed to expert (or assassin if evil) for the cost of two "other" skill selections.

O.C.C. Related Skills: Select four "other" skills, plus select one additional skill at levels four, eight, and twelve. All new skills start at level one proficiency.

- Communications: Any (+10%)
- Domestic: Any
- Electrical: Any (+20%)
- Espionage: None
- Mechanical: Any (+20%)
- Medical: First aid only (+10%)
- Military: Any (+10%)
- Physical: Any, excluding acrobatics and wrestling.
- Pilot: Any (+10%)
- Pilot Related: Any (+10%)
- Rogue: Any (+5%)
- Science: Any

Technical: Any (+10%)

W.P.: Any

Wilderness: None

Secondary Skills: The character also gets to select two secondary skills from the list, excluding those marked "None," at levels two, four, seven, ten and thirteen. These are additional areas of knowledge that do not get the advantage of the bonus listed in parentheses. All secondary skills start at the base skill level.

Standard Military issue for Field Mechanics: T-13 mechanic body armor (with special optics), T-42 or T-30 rifle, 4 smoke grenades, 2 fragmentation grenades (2D6 M.D.), 6 signal flares, survival knife, flashlight, distancing binoculars, laser distancer, hand-held computer, portable tool kit, portable laser torch and laser wand (both the same as Wilk's), large tool box and tools, utility belts, additional air filter and gas mask, portable language translator, walkie-talkie (for when not in armor), four overalls, two standard uniforms and one dress uniform.

Equipment Available Upon Assignment: T-11 Enhanced body armor, X-60 Flanker, T-100 Eagle jet pack, additional weapons, energy clips, vehicles, and equipment. The character also has access to most military bases (low to mid-level security clearance), military garages, hangars, storage bays, and repair/mechanic shops, as well as access to computers and mechanic data systems. **Note:** Availability of equipment and resources may be dependent upon the local commander, supply stock, location, casualties and combat conditions. However, the field mechanic usually gets priority regarding robot replacement systems and parts, T-13 and T-11 body armor, mechanic tools, and access to mechanic/repair facilities.

Money: The mechanic gets a roof over his head, food, clothing, access to medical facilities and all other basic needs provided free as part of his/her pay. The mechanic also receives a monthly salary of 3000 credits (the savings of a first level character is $2D4 \times 1000$ credits). High ranking officers (9th level and higher) get 4200 credits a month. The pay may sound low, but this character is not concerned with money alone. Like most soldiers in the NGR military, they are concerned most with defending their homeland.

When not in the field, the mechanic shares a three bedroom apartment with two other mechanics. In addition to the three bedrooms, the apartment has one bathroom, living room, and a study/library room. Other perks include a stereo, video system and personal computer. Or the mechanic can opt to live off base at his own expense.

Rank: Standard military; private to lieutenant colonel.

Cybernetics and Bionics: A universal hand or headjack and two cybernetic augmentations from any category — usually sensory augmentation such as gyro-compass, amplified hearing etc. See the **Rifts RPG** and the cybernetic section in this book for the full range of available items. Favorite types of cyber-devices include lung, eye and sensor implants.

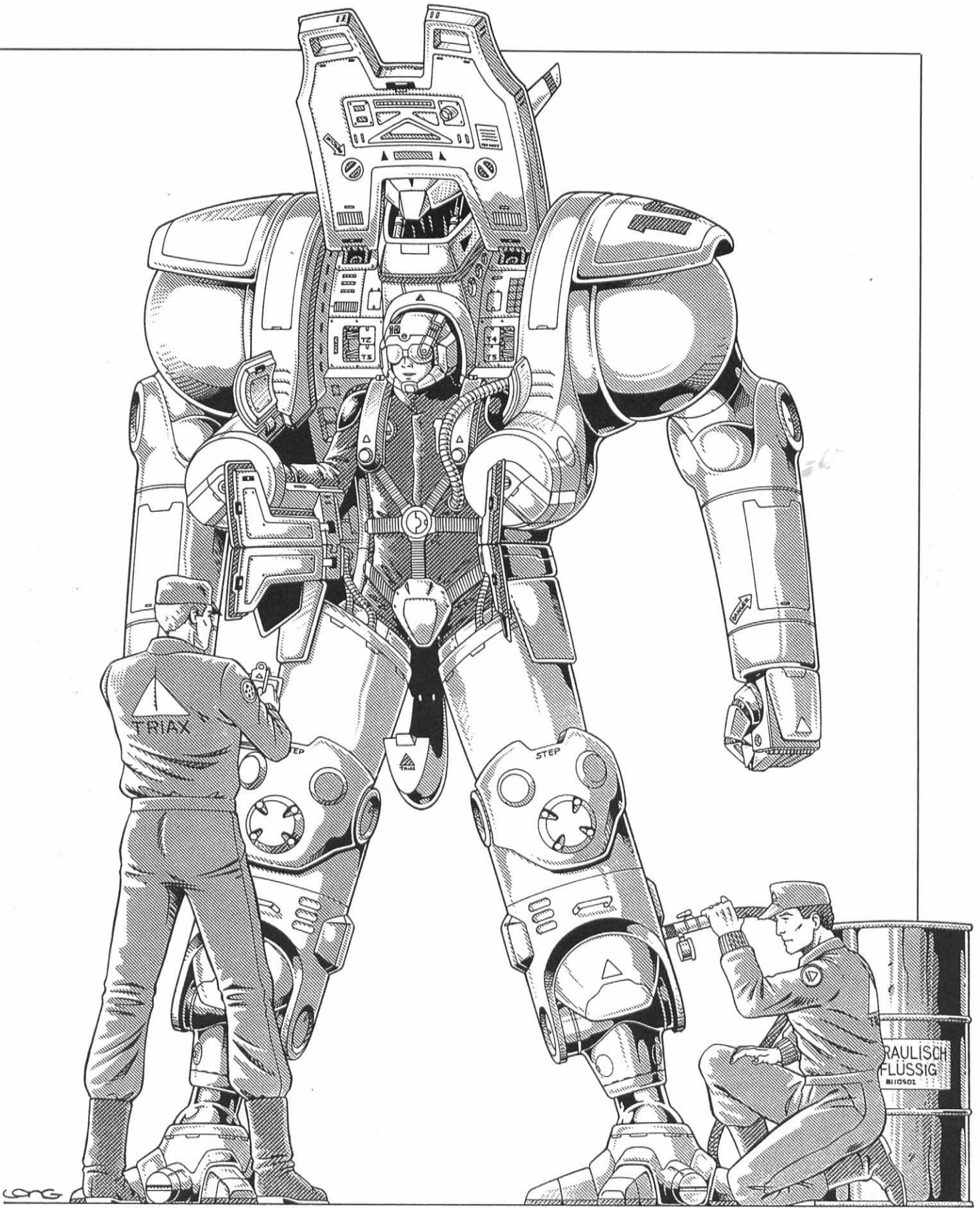

Power Armor Commando O.C.C.

The P.A. commando is a specialist in the use of combat power armor, explosives and heavy weapons. He is a skilled operator of all man-size power armor, as well as having a familiarity with most robot vehicles. In most cases, the job of the power armor commando is to get in, do the job and get out.

It is the power armor commando who is given the T-31 Super Trooper as standard issue ordnance and sent out to engage giant enemy robots, tanks and assault vehicles, one on one, man against machine! Typical commando assignments include seek and destroy, sabotage, anti-armor assaults, enemy penetration, and rescue missions, most of which take place behind enemy lines.

Attribute Requirements: I.Q. 11, M.E. 12, P.S. 14, and P.P. 14 or higher.

O.C.C. Skills:

Math: Basic (+20%)
Literacy: Euro (+30%)
Language: Euro (+30%)
Language: Select one additional (+10%)
Radio: Basic (+20%)
Radio: Scrambler (+20%)
Computer Operation (+10%)
Intelligence (+10%)
Pilot Jet Pack (+10%)
Pilot Hover Vehicles (+10%)
Pilot Robots & Power Armor (+10%)
Robot Combat Elite: T-31 Super Trooper
Robot Combat Elite: X-10A Predator
Robot Combat Elite: Jager (both types)
Climbing (+10%)
Running
Demolitions (+20%)
Demolitions Disposal (+20%)
W.P. Energy Rifle
W.P. Heavy Energy
Hand to Hand: Expert

Hand to hand: expert can be changed to martial arts (or assassin if an evil alignment) at the cost of one "other" skill selection.

O.C.C. Related Skills: Select five other skills, plus select one additional skill at levels three, six, nine and twelve. All new skills start at level one proficiency.

Communications: Any (+15%)
Domestic: Any
Electrical: Basic electronics only (+10%)
Espionage: Any (+5%)
Mechanical: Automotive and basic mechanics only (+10%)
Medical: First aid only (+10%)
Military: See O.C.C. skills.
Physical: Any, excluding acrobatics
Pilot: Any (+5%)
Pilot Related: Any (+10%)
Rogue: Any (+2%)
Science: Any
Technical: Any (+10%)

W.P.: Any
Wilderness: Any

Standard Military issue for Power Armor Commandos: T-31 Super Trooper, T-11 Enhanced body armor, T-100 Eagle jet pack, rail gun or heavy weapon of choice, energy rifle of choice (typically TX-42, TX-30, or TX-16 pump rifle), 1D4 tear gas grenades, 1D4 smoke grenades, 1D4 fragmentation grenades (2D6 M.D.), 1D4 plasma grenades (5D6 M.D.), survival knife, flashlight, distancing binoculars, utility belt, gun holster(s) additional air filter and gas mask, walkie-talkie (for when not in armor), four standard uniforms and one dress uniform.

Equipment Available Upon Assignment: Any man-size power armor, including all T-series armor, X-10A Predator, X-60 Flanker, X-535 Jager, X-545 Super Jager and X-1000 Ulti-Max.

Additional weapons, energy clips, and vehicles, medical kit, portable computer, portable language translator, cameras, surveillance equipment, and explosives, including fusion blocks. The commando also has access to most military bases and has mid-level security clearance. **Note:** Availability of equipment and resources may be dependent upon the local commander, supply stock, location, casualties and combat conditions. However, the commando usually gets priority treatment regarding the allocation of power armor, heavy weapons, and explosives.

Money: The power armor commando gets a roof over his head, food, clothing, access to power armor storage, robot hangars and maintenance areas, and all other basic needs provided free as part of his/her pay. The monthly salary is 2600 credits (the savings of a first level character is $2D4 \times 1000$ credits). High ranking officers (9th level and higher) get 4000 to 6000 credits a month. The pay may sound low, but this character is not concerned with money alone. Like most soldiers in the NGR military, the commando is concerned most with defending his homeland.

When not in the field, this special forces soldier is given use of a private apartment on or near a military base. The apartment has a private bathroom, tiny kitchenette (with refrigerator and microwave oven), living room, bedroom and a study/library, and comes complete with a stereo, video system and private computer.

Rank: Standard military; private to general.

Cybernetics and Bionics: Select two cybernetic augmentations from any category — usually sensory augmentation such as gyro-compass, universal headjack, amplified hearing etc. See the **Rifts RPG** and the cybernetic section in this book for the full range of available items. Favorite types of cyber-devices include lung, eye and sensor implants.

Secondary Skills: The character also gets to select two secondary skills from the list, excluding those marked "None" at levels one, four, seven and eleven. These are additional areas of knowledge that do not get the advantage of the bonus listed in parentheses. All secondary skills start at the base skill level.



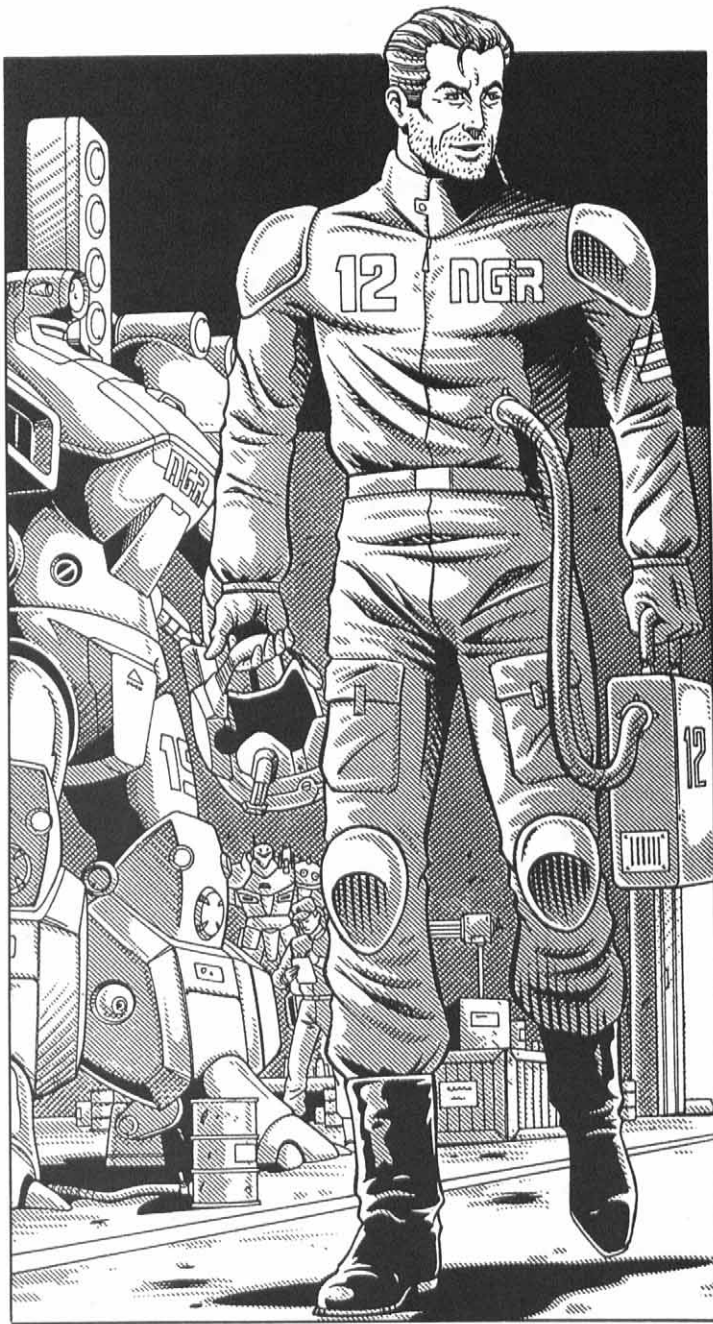

Robot Combat Pilot O.C.C.

The robot combat pilot is seen as one of the glamorous, elite military occupations. The characters are the hot-shots who pilot combat robots like the Dragonwing, Black Knight, Dyna-Max and Devastator into battle. They are specialists in the use of giant robots, military aircraft, and armored assault vehicles. In most cases, the job of the combat pilot is to engage the enemy head on and penetrate enemy lines. They are also used to defend strategic positions, safeguard civilian cities and military bases, provide support for ground troops, seek and destroy missions, reconnaissance, and rescue missions.

Attribute Requirements: I.Q. 9, M.E. 13, and P.P. 13 or higher.

O.C.C. Skills:

Math: Basic (+20%)
 Literacy: Euro (+30%)
 Language: Euro (+30%)
 Language: Select one additional (+20%)
 Radio: Basic (+10%)
 Radio: Scrambler (+10%)
 Computer Operation (+10%)
 Read Sensory Equipment (+20%)
 Weapon Systems (+10%)
 Navigation (+15%)
 Pilot Hover Vehicles (+20%)
 Pilot Jet Aircraft (+30%)
 Pilot Jet Fighter (+30%)
 Pilot Robots & Power Armor (+20%)
 Robot Combat Elite: X-1000 Ultra-Max
 Robot Combat Elite: X-2000 Dyna-Max
 Robot Combat Elite: Black Knight
 Robot Combat Elite: One of Choice
 Running
 W.P. Energy Rifle
 Hand to Hand: Expert

Hand to hand: expert can be changed to martial arts (or assassin if an evil alignment) at the cost of one "other" skill selection.

O.C.C. Related Skills: Select four "other" skills, plus select one additional skill at levels four, eight and twelve. All new skills start at level one proficiency.

Communications: Any (+5%)
 Domestic: Any
 Electrical: Basic electronics only (+10%)
 Espionage: None
 Mechanical: Automotive and basic mechanics only (+10%)
 Medical: First aid only (+10%)
 Military: None
 Physical: Any, excluding acrobatics
 Pilot: Any (+15%)
 Pilot Related: See O.C.C. skills.
 Rogue: None
 Science: Any
 Technical: Any (+10%)
 W.P.: Any
 Wilderness: Land navigation and hunting only.

Secondary Skills: The character also gets to select two secondary skills from the list, excluding those marked "None," at levels one, three, seven and eleven. These are additional areas of knowledge that do not get the advantage of the bonus listed in parentheses. All secondary skills start at the base skill level.

Standard Military issue for Robot Combat Pilots: X-2000 Dyna-Max, T-10 body armor, energy rifle of choice (typically TX-42, TX-30, or TX-16 pump rifle), flashlight, distancing binoculars, utility belt, gun holster(s), additional air filter and gas mask, walkie-talkie (for when not in armor), canteen, four standard uniforms and one dress uniform.

Equipment Available Upon Assignment: Any of the X-series robots, additional weapons, energy clips, aircraft and assault vehicles. T-40 "plain clothes" body armor, medical kit, portable computer, and language translator. The combat pilot also has access to most military bases (mid to high level security

clearance), hangars and facilities. **Note:** Availability of equipment and resources may be dependent upon the local commander, supply stock, location, casualties and combat conditions. However, the robot combat pilot usually gets priority treatment regarding the allocation of X-series robots, assault vehicles, aircraft and parts and ammunition for said bots and vehicles.

Money: The robot combat pilot gets a roof over his head, food, clothing, access to power armor storage, robot hangars and maintenance areas, and all other basic needs provided free as part of his/her pay. The monthly salary is 2800 credits (the savings of a first level character is $2D4 \times 1000$ credits). High ranking officers (9th level and higher) get 4300 to 6000 credits a month. The pay may sound low, but this character is not concerned with money alone. Like most soldiers in the NGR military, the robot combat pilot is concerned most with defending his homeland.

When not in the field, this special forces soldier is given use of a private apartment on or near a military base. The apartment has a private bathroom, tiny kitchenette (with refrigerator and microwave oven), living room, bedroom and a study/library, and comes complete with a stereo and video system and private computer.

Cybernetics and Bionics: Gyro-compass, headjack and ear implant to start. Additional cybernetics may be purchased or given as an award for outstanding service in the line of duty.

Robot Soldier Optional O.C.C.

Triax is trying to develop a number of different ways to give robots human intelligence. The typical combat robot is humanoid in shape with legs, arms, weapon systems and a computer brain. They are not alive, do not have simulated emotions, do not have a human voice, and are programmed in such a way that they show little human character. This is done to prevent humans, particularly soldiers in the field of battle, from getting emotionally attached to their mechanical associates. Robots are a non-living, non-sentient tool, like a computer or vehicle. These machines are NOT available as player characters!

Robots that can be used as player characters delve into the realm of Triax experimentation. The robot manufacturer has been experimenting with three different ways to place a robot under the direct control of a human intelligence without that human being as a *physical* part of the robot. Currently, a human operator/pilot is placed "into" the robot vehicle or power armor, or made into a cyborg. The three current areas of study and experimentation are:

Virtual reality

M.O.M transmission of intelligence

Brain transplant

Virtual Reality

The area of robot manipulation/control via virtual reality, seems to be the most promising. Through virtual reality a human pilot can control and direct a robot without actually being inside of it or using a conventional remote control. The human operator controls the bot by wearing a virtual reality exo-skeleton composed of thousands of micro-circuits and electrodes. Every portion of the human body is covered; gloves on the hands, a helmet over the head, and the legs, arm, neck and torso are all sheathed in the elaborate electrode suit. Once the suit is engaged, the robot and operator are linked and move as one.

Like a giant marionette, the robot responds to the actions of the VR pilot, mimicking his every movement. Through the eyes and sensors of the bot, the pilot sees, hears and experiences everything the robot does. The virtual reality helmet and sensor suit creates an artificial environment that seems completely real to the operator. So real that the character will feel as if he is actually on the field of combat, while he is actually nestled safely away in a fortified bunker or an armored vehicle hundreds of miles from the actual conflict. His "VR image self," is the robot which responds to the environment with enhanced speed, strength and power. The Virtual Reality (VR) pilot reacts as he would as if he was the robot, living the experiences of his surrogate body.

The need for a physical control console, verbal commands and the physical manipulating of said elements has been eliminated with the virtual reality system. If the robot must leap out of the way, or fire eye beams, it happens as quickly as the VR pilot thinks it or gestures with his human body. The robot responds to every movement of the operator. Movements which are supplemented by the robot's mechanical prowess, weapons and enhancements.

The two great advantages of the virtual reality piloting system is that no human life is put in danger and the robot is controlled by a human brain. Thus, it exhibits the subjective decision making power and intuition of a human being, since there is a human guiding its every move. **Note:** A VR pilot can direct only one robot at a time.

Problem Areas:

1. **Range:** Maximum range is 500 miles (804 km). There are plans to build virtual reality robot control modules in APCs, aircraft or similar armored vehicles that can follow the robot at a safe distance, a few hundred miles away, to extend the active range. If either the bot or the VR pilot is teleported out of range or rifted to another world, the robot freezes in its tracks and completely shuts down.

2. **Communications interference:** Sophisticated radio jamming techniques, solar flares, unusual ley line activity or the appearance of a dimensional rift disrupts the virtual reality link and causes delayed reactions and reduced performance (-3 on initiative, no combat bonuses, and reduce the number of melee actions/attacks by half).

3. **Operator Fatigue:** The VR pilot moves with the actions of the robot he controls. If the robot needs to run somewhere, the pilot runs in place or on a treadmill. To block a punch, the pilot raises his arms and the robot mimics the action. Obviously, this can be almost as strenuous as being in the field of combat. The VR system and augmentation from the exo-skeleton sensor

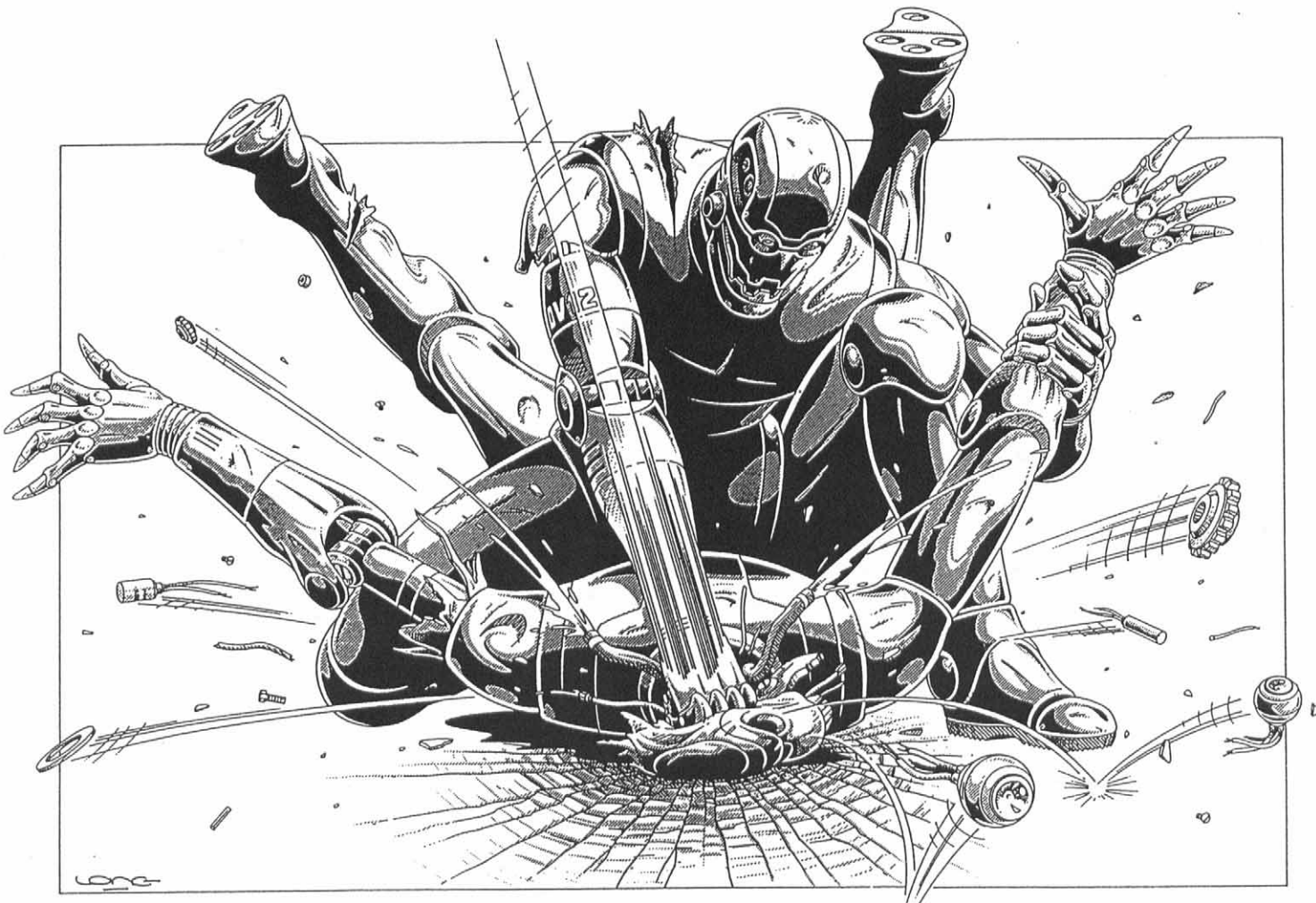

suit reduces the VR pilot's normal fatigue rate by half, but he will still need to take rests as he may slow down with his senses dulled after a few hours of strenuous activity. This can be solved with rest breaks or quickly switching places with a fresh pilot who takes over for awhile. Four man teams are currently being tested.

4. **Vulnerability of the Pilot:** If the VR pilot is injured or otherwise impaired (drugs, psionics, magic, etc.) the robot will also be impaired. If the pilot is killed, the robot will freeze until another VR pilot can be "plugged in" to take over its control.

5. **Psychological problems:** The virtual reality system distorts reality and occasionally causes mental traumas.

A. **The adventure junkie:** VR pilots experience the same adrenal rush and emotional excitement from virtual reality experiences as if one was physically present on the battlefield. Some pilots become addicted to the excitement. The character grows to crave action and adventure regardless of the consequences. If allowed to do so, adventure junkies will spend most of their waking hours in virtual reality and request the most dangerous assignments. If denied, the adventure junkie will seek his thrills elsewhere, usually by putting himself and/or those around him in danger. Thrill seeking escapades can include dangerous sports, races, death defying feats, brawls, duels (increased aggression), and foolish risk taking. Some will turn to drugs or Juicer augmentation to satisfy their need for adventure in the fast lane. About 50% of the VR pilots will suffer from some degree of adventure addiction.

B. **Schizophrenia:** VR schizoids are much less common (10%). Like the adventure junkie, the character gets hooked on excitement and adventure. However, in this instance the pilot also suffers from delusions, making it increasingly difficult for him/her to distinguish between reality and fantasy. The schizoid will typically hear voices encouraging dangerous actions and will slip from one reality into another, reliving past combat experiences.

The schizoid tends to be reckless and uncontrollable. He may slip into a berserker fighting spree (40% chance), stopping only when his opponents are defeated, surrender, or until he is rendered unconscious or killed. Some schizoids also become paranoid.

C. **VR Manic depression:** The character is quiet, grumpy, lethargic, and depressed when not "plugged in" or active in some other stimulating situation. He becomes instantly energetic, excited, alert and happy (manic) when involved in action; the more dangerous, the better (VR combat preferred). When manic, the individual is hyper, charismatic, daring, very alert and requires a third of the time to rest or sleep and still functions at peak efficiency.

D. **Phobias and other complications:** The VR pilot may also suffer from phobias and trauma from his very seemingly real experiences piloting a robot. However, these must be extremely frightening or horrific experiences.

Note: Also see **Mutants in Orbit** for a slightly different virtual reality robot control system created by the Cyberworks Corporation.

M.O.M. Conversion for transmission of intelligence

The concept is to create a process by which the human consciousness/mind can be transferred from a living body into a robot body! From the subject's point of view he has temporarily exchanged his flesh and blood body for a more powerful, mechanical one. This is different than bionics which augments the human body and has some percentage of organic parts and internal organs. In this case, the mechanical body would be a standard robot with a special housing that would contain a human mind without a living brain or body to control it.

Mind Over Matter (M.O.M.) brain implants have always been dangerous and are outlawed in the NGR. Triax has gotten special permission from the government to pursue this area of development, but even they feel uncomfortable with this research. To compound the problem Triax has never been involved with M.O.M. conversions so development comes slow and hard.

The big problem is that M.O.M. implants have always resulted in mental instability and subsequent serious insanity for the implant recipient. Triax has finally developed an experimental mind transference process that works, but it is fraught with problems.

Problem areas:

1. Muscle atrophy: The human body falls into a coma when the human mind is transferred into a robot. If the mind is away from its body for a long period of time, the dormant muscles become weak and atrophy. The Triax tech wizards have solved the problems of muscle atrophy by putting the body in a light exo-skeleton that can be operated by remote control and made to walk and perform rudimentary exercises. This process is also applied to coma victims in NGR hospitals.

2. Physical deterioration over long periods of time: Food consumption, calorie intake and weight loss are the next problems in maintaining the dormant human body. For short periods of hours there is nothing to worry about. The absence of a mind for two or three days also represents no serious concern — it is easy to nourish the body via intravenous feeding and vitamin supplements. Even no nourishment or water over such short periods of time will cause no serious or permanent damage. It is long periods of weeks, months or even years that becomes a problem. The body can be kept alive, nourished and exercised, but there is still some degree of deterioration, weakness of muscles and weight loss.

Six months is the recommended maximum safe period. After a year, reduce the body's weight and physical attributes by 10%. After two or three years 20%, four years 30%, five to 10 years 40%. However, when the mind is finally returned to the body, the character can regain his weight, physical attributes and get back into top condition within one to eight months depending on the degree of physical deterioration. Beyond ten years the character will need to spend a year to repair the damage done to his body.

3. Protecting the human body: There is also the issue of protecting the body from damage and supernatural possession. If the physical body is destroyed, the character is forever trapped inside the robot shell!

There is absolutely no protection against supernatural or psionic possession. The body is an empty shell. A master psionic,

possessing entity or other supernatural being can take total control without any battle of wills, steal the body and use it for its own diabolic purposes. Most possessing beings will have little or no regard about damaging or destroying the body.

4. Accidental disconnection from the robot: If the robot is destroyed the human mind that controls it is thrown out of its mechanical body and into the astral plane. It has two hours to locate its human body and reenter it or fade away and both mind and body die! Finding its body can be done the same way as an astral traveler returns to his physical body. The abrupt disconnection and subsequent fears and disorientation are very traumatic. Roll first to see if the the ordeal has caused an insanity:

01-50 Means the character is shook-up but okay.

51-00 Means trauma. Roll on the Random Insanity Table found in the **Rifts RPG**, page 19.

5. Insanity: One of the problems with M.O.M. implants has always been negative psychological side-affects. The robot transmission experiments have been no different. Psychological and emotional aberrations manifest themselves after as few as two, short transference periods.

Without exception, the subject develops a "super hero" complex, i.e. he immediately enjoys and craves the superhuman power and abilities he possesses when in the robot body. This feeling usually quickly develops into one or all of the following:

A. Wants to be in the robot body 80% of his waking hours. Only regrets/losses are the pleasures of eating/tasting food and drinks, sexual contact, and general human contact/touch.

B. Feels vulnerable and inferior in the human body. A psychological block causes the following penalties when in his human body: -20% on skill performance, -3 on initiative, -2 on all combat bonuses that result from training or physical attributes. Furthermore, the character is lethargic and melancholy which may lead to drug and/or alcohol abuse (roll percentile, 01-40 indicates abuse). Penalties and chemical dependency disappear when in the robot body and the character is alert, happy and energetic.

C. Feelings of vulnerability develop into 1D6 phobias (01-70) or acute paranoia (71-00). Phobias or paranoia disappear when in the robot body.

D. Megalomania! The character develops a "god" complex and becomes obsessed with power in both his human and robot forms. This pervasive feeling also causes a disassociation with humans and all weaker/mortal beings and instills an arrogance and aloofness toward most humans and D-bees. This can lead to a lack of human compassion and kindness and may result in anti-social behavior, extreme callousness, verbal and physical abuse, violence and murder.

Brain Transplant

From a strictly technical position, the transplant of a human brain into an artificial body is a full cyborg conversion. Normally, when a human brain is placed into a completely artificial body (i.e. cyborg), that body is an "all-purpose" housing and designed to have a relatively human appearance and emulate the human senses. The bionic body is much more powerful than a flesh and blood, human body, but it is not as powerful as most Triax combat robots.

The brain transplant is listed as one of the possible robot O.C.C.s because it departs from the standard bionic conversions. First, there is no human body to augment, only a human brain. Second, the brain is NOT placed into one of the standard cyborg bodies but into a combat robot.

What the NGR has authorized is experimentation in putting a human brain into a combat bot, such as the DV-40 Hunter/Killer drone. The bot has no human cosmetics and is fully armed. The difference is rather than being animated and directed by a computer and programs, it is completely controlled by the human mind.

The advantage of a human brain controlling a bot is that the human mind and personality of that individual can use human intuition, experience, and compassion that robots cannot. The human mind is capable of making subjective decisions, acting on hunches, and showing a wider range of decision making in general. On the down side, the human mind is still vulnerable to mind control, illusions and other forms of psionic attack, even with psionic dampers in place. Similarly, the human mind is subject to stress, fatigue, insanity and emotional outbursts.

All candidates for this radical procedure are volunteers from the military, usually career soldiers who have promised to remain in active military service. They are fully aware that they are expected to perform in the field of combat as frontline infantry units. These candidates are carefully screened and given a complete psychiatric evaluation. The transplant is only performed when the volunteer's natural body is damaged beyond repair and cybernetic conversion or death are the only options. If the character has volunteered for robot conversion and has passed earlier screening, the brain is cybernetically connected to a specially prepared combat robot.

The NGR is very humane in regards to the human condition and the rights of the individual. Consequently, the soldier is completely aware of the consequences of his actions and could have instructed his superiors to let him die or to be placed in a humanoid, non-combat cybernetic body. **Note:** Although the rights of non-humans are virtually nonexistent, the NGR would NEVER consider using non-humans in such an experiment or allow their use in matters of national security.

All in all, these experiments have been an overwhelming success. Surprisingly, the brain transplant subjects show high spirits and sound minds — few suffer from any signs of psychological distress or aberration. The most stressful aspect is getting used to the mechanical body and lack of human sensations like taste, smell and touch. Sight, hearing, and, to a lesser extent, touch (about 50% of normal) are simulated by the robot's sensors and optics. In other ways, the mind's attunement to the robot's sensory systems, optics and computers actually creates a pleasant sense of heightened awareness, agility and strength. Still, there are no plans to increase the current number of volunteers or lower the current eligibility standards for the program. **Note:** Less than .02% of the NGR troops have been cybernetically converted into combat robots.

The Robot Soldier

Available Robot Types

The following robots are available to any of the three types of robot soldiers.

Any EIR

DV-12 Dyna-Bot

DV-13 Dyna-Bot

DV-15 Sentry Bot

DV-40 Hunter/Killer Bot

X-545 Jager Super Hunter (modified)

X-2000 Dyna-Max (modified)

X-2500 Black Knight (modified)

X-2700 Dragonwing (modified)

Note: The X-series robot vehicles have been modified in such a way that a pilot is not needed nor can a pilot override or control the bot in any way. Every function of the bot is controlled by the transplanted brain. However, seats where a pilot and passengers might have sat can still be accessed to accommodate passengers inside the robot. No other robot vehicles or bodies are currently available to the robot soldier. Once a body has been selected the soldier rarely changes it.

Robot Soldier O.C.C. stats, notes & bonuses applicable to all three types of robot soldiers

The brain or transferred mental essence is located in a protective, environmental housing and inside the mega-damage body of a robot. Consequently, it is impervious to heat, cold, gases, drugs, toxins, pollution and even radiation. If the bot can operate underwater or in outerspace (most can) the brain or essence is protected and continues to function as normal. If the robot's body is destroyed, shut down or incapacitated, the brain inside is likely to survive. Only if the robot is atomized (suffers double its main body in damage) would the brain be destroyed or mental essence released. Otherwise, the housing can be retrieved and installed in a new body. The brain can survive for two weeks without its robot body and power supply.

Most of the physical abilities such as strength, speed, leaping, flight, weapon systems, etc., are exactly the same as those of the robot described in the Triax robot section. The following differences and bonuses are a result of the human mind and mental reactions.

- 1. Combat Bonuses:** All the following combat bonuses are in addition to any mechanical or sensor bonuses of the bots.
 - +2 on initiative,
 - +1 to strike and parry
 - +2 to roll with impact
 - +2 to pull punch
- 2. Melee Actions:** The number of attacks/actions per melee reflects the living human's past experience and training in a specific type of hand to hand skill. However, the robot body, reflexes and sensory systems provide one additional melee attack/action at levels two, six and twelve.
- 3. Mental bonuses:** In addition to the mental bonuses listed, the brain only needs six hours of sleep per 24 hours. Yes, even a disembodied brain needs time to relax, sleep and dream.
 - +3 to save vs horror factor.
 - +2 to save vs illusion and psionic attack.
 - +2 to save vs magic.

4. **Life expectancy:** Ruling out combat damage, the life of the average robot is an estimated 50+ years; possibly 100+ years with proper maintenance and minimal damage. The typical robot energy supply has a life of 10 to 20 years and can be replaced as needed. The robot soldier's energy source has a 25 year life. The life of the transplanted brain or transferred mental essence under these conditions is unknown. It has been suggested that they could live and function for 200 years or longer. At this point, it's all speculation.
5. **Skills and the human mind:** The human mind inside the bot is the true intelligence behind the machine's actions. Thus, the character's past O.C.C. training and skills (presumably one of the military O.C.C.s) constitutes the robot soldier's primary range of skills. Whatever level of experience he or she may have been will reflect the character's proficiency with regard to specific skills. All skills are frozen at the level of when the soldier underwent the robot conversion. The character then begins life and experience reborn as a robot. When the robot soldier reaches the equivalent experience level under the Robot O.C.C., his skills begin to improve with each subsequent level. For example: A soldier who was sixth level will not improve/increase his skill proficiencies until he reaches seventh level as a robot soldier. This makes sense because the character will spend a long period of time learning about and adjusting to his new mechanical body. Furthermore, he must also focus on the war and field operations.

Additional Robot Programming is possible: A robot drone will be designed to perform specific tasks and given the corresponding programming, to execute those tasks. The human brain cannot be programmed like a computer (although the forces behind Mindwerks would contend otherwise). The human mind controlling the robot must learn skills the same as any human and only improves through practice and experience. However, three basic skill programs can be programmed into the robot's supplemental computer and accessed by the human brain. Accessing is no different than when a city rat or borg links to a computer via a headjack. This means the robot soldier can "read" a library of information stored on disk, play games, listen or watch the news, television and movies. Similarly, a limited number of specific skills can be accessed. When one of these skill areas is pulled up, the human mind can hear a fundamental, step by step instruction on how to perform that skill. Illustrations, diagrams, charts, and graphs may accompany the instructions.

The skill proficiency is roughly equal to being "talked through" a procedure, except that the computer will transmit sensory information and graphics to help the character understand and perform the skill. Base skill: 38%; no bonuses or improvement with experience. Penalty: The task takes 1D4 times longer.

Available Skill Programs: Programs are the same as the skill categories available to an O.C.C.; all the skills under that category are part of the skill program unless otherwise noted.

Remember, skill proficiency is limited to 38%. As many as three skill programs/categories can be selected.

Communications: All

Domestic: All

Electrical: Basic electronics and computer repair only

Espionage: Tracking, intelligence, and wilderness survival only.

Mechanical: All, except mechanical engineer and robot mechanics.

Medical: Paramedic and forensics only

Military: All, but not recommended!

Physical: All, except acrobatics, gymnastics, wrestling and prowl.

Pilot: All, except pilot robots & power armor and robot combat.

Rogue: None

Science: All

Technical: All, except lore.

W.P. All Modern

Wilderness: All

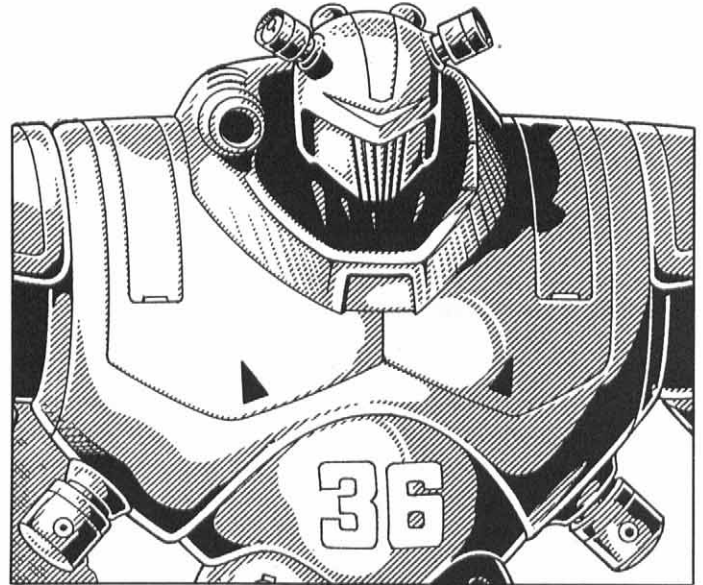

Equipment Available Upon Assignment: The robot soldier gets the usual equipment and weapons assigned to that particular robot. Most human-size bots can use rail guns and heavy weapons, pilot vehicles and so on. Additional weapons, explosives and equipment are available as needed for assignment. In many instances, especially with larger bots, the machine will come equipped with an array of sensors, weapons and features. The robot soldiers also have access to most military bases (mid to high level security clearance), hangars, maintenance shops and facilities. **Note:** Availability of equipment and resources may be dependent upon the local commander, supply stock, location, casualties and combat conditions. However, the robot soldier gets top priority regarding the allocation of robot parts, robot weapon systems, repairs and maintenance.

Money: The robot soldier has few human needs. Human-size bots can live in or share the same facilities as humans, whether living quarters is a barracks or an apartment. Of course, their mechanical body allows the robot soldier to endure environments that would be inhospitable or even lethal to humans. Giant robots are assigned a private garage/hangar as a place to sleep, rest and to call their abode.

The monthly salary is 3500 credits (the savings of a first level character is $2D6 \times 1000$ credits). High ranking officers (9th level and higher) get 5000 to 9000 credits a month. The military also provides complete maintenance, repairs and equipment free of charge.

NGR Intelligence Division

Intelligence Officer O.C.C.

Espionage Agent/Spy

The intelligence officer is a military specialist whose expertise is in the area of espionage, reconnaissance, communications and information gathering. They are also masters of disguise and the arts of escape. Most are quick thinking, resourceful, charismatic and confident men who remain cool under fire. It is the intelligence officer who will lead reconnaissance missions and act as a spy or undercover agent to infiltrate the enemy. They are also involved in sabotage, surveillance, impersonation, robbery, assassination, rescue missions, prison breaks, and all types of covert operations. The character's services are utilized by both the intelligence division and the civilian law enforcement branch of the military.

Attribute Requirements: I.Q. 10, M.A. 14 or higher. A high M.E. and P.S. are helpful but not a requirement.

O.C.C. Skills:

Math: Basic (+10%)
Literacy: Euro (+30%)
Language: Euro (+30%)
Radio: Basic (+20%)
Radio: Scrambler (+20%)
Radio: Laser (+10%)
Surveillance Systems (+10%)
Computer Operation (+15%)
Disguise (+20%)
Escape Artist (+20%)
Intelligence (+20%)
Pilot skill of choice (+20%)
Pilot Jet Pack (+20%)
Pilot Robots & Power Armor (+5%)
General Athletics
Climbing (+10%)
Swimming (+10%)
W.P. Energy Rifle
Hand to Hand: Martial Arts

Hand to hand: martial arts can be changed to assassin if the character has an anarchist or evil alignment.

O.C.C. Related Skills: Select two rogue skills and three "other" skills. Select one additional skill at levels three, seven, eleven and fifteen. All new skills start at level one proficiency.

Communications: Any (+10%)
Domestic: Any (+5%)
Electrical: Basic electronics only (+5%)
Espionage: Any (+10%)
Mechanical: Basic mechanics only (+5%)
Medical: First aid only (+10%)
Military: Any (+20%)
Physical: Any
Pilot: Any (+10%)

Pilot Related: Any (+10%)
Rogue: Any (+10%)
Science: None
Technical: Any (+10%)
W.P.: Any
Wilderness: Any (+5%)

Secondary Skills: The character also gets to select two secondary skills from the list, excluding those marked "None," at levels two, four, eight, and twelve. These are additional areas of knowledge that do not get the advantage of the bonus listed in parentheses. All secondary skills start at the base skill level.

Standard Military issue for the Intelligence Officer: T-10 body armor and T-11 Enhanced body armor, T-100 Eagle jet pack, energy rifle of choice, sidearm of choice, four extra energy clips for each, vibro-blade of choice, survival knife, 2 smoke grenades, 2 fragmentation grenades (2D6 M.D.), 2 plasma grenades (4D6 M.D.), hand-held computer, language translator, flashlight, distancing binoculars, canteen, utility belt, backpack, additional air filter and gas mask, walkie-talkie (when not in armor), two standard uniforms and one dress uniform.

Equipment Available Upon Assignment: Additional body armor, weapons and equipment, surveillance equipment, cameras, recording equipment, computers, sensory equipment, access to the T-Series power armor and X-Series robots, EIR-15 gargoyle bot, and other military vehicles or means of transportation. The character also has access to most military bases and facilities (high to the highest security clearance). **Note:** Availability of equipment and resources may be dependent upon the local commander, supply stock, location, casualties and combat conditions. The intelligence officer always has priority over surveillance and communications equipment, explosives, cybernetics, EIR's and weapons.

Money: The intelligence officer gets a private two bedroom apartment with a study, living room, kitchenette and private bath. The monthly salary is 2500 credits (the savings of a first level character is 2D4 × 1000 credits). High ranking officers (8th level and higher) get 4500 to 8000 credits a month.

Rank: Standard military; however, as an "officer" even first level characters start at the rank of lieutenant.

Cybernetics and Bionics: Gyro-compass, clock calendar, universal headjack and ear with amplified hearing and a toxic filter are standard to start. High ranking officers (8th level or higher) are likely to have the following additional implants: one or two cybernetic eyes (bio-system or cyber), one additional lung implant, cyber-disguise type AA-1, or a cybernetic finger or two, or even an artificial arm. Others can be purchased or awarded for acts of heroism, or provided for a specific mission.

Intelligence Commando O.C.C.

Guerilla Warfare & Wilderness Scout

The intelligence commando is a military specialist whose area of expertise is espionage, tracking, and guerilla warfare. They engage in missions of seek and destroy, tracking fugitives, sabotage, rescue and reconnaissance. The intelligence commando is an expert in the combat tactics, habits and resources of the enemy. In many respects, they serve as "monster hunters" and exterminators! They are also involved in all sorts of covert operations. The character's services are utilized by both the intelligence division and the civilian law enforcement branch of the military.

Attribute Requirements: I.Q. 9, P.E. 14, P.S. 9, or higher. A high P.S., P.P. and Spd are encouraged but not a requirement.

O.C.C. Skills:

- Math: Basic (+10%)
- Literacy: Euro (+30%)
- Language: Euro (+30%)
- Lore: Demons & Monsters (+20%)
- Radio: Basic (+20%)
- Computer Operation (+15%)
- Intelligence (+20%)
- Land Navigation (+14%)
- Tracking: Humans/monsters (+20%)
- Tracking: Animals (+10%)
- Wilderness Survival (+20%)
- Pröwl (+10%)
- Pilot skill of choice (+20%)
- Pilot Robots & Power Armor (+5%)
- Robot Combat Elite: Power Armor of choice or X-10A, X-60 or X-500
- General Athletics
- Climbing (+10%)
- Swimming (+10%)
- S.C.U.B.A.
- W.P. Energy Rifle
- W.P. Heavy Energy
- Hand to Hand: Martial Arts

Hand to hand: martial arts can be changed to assassin if the character has an anarchist or evil alignment.

O.C.C. Related Skills: Select two W.P.s of choice and three "other" skills, plus select one additional skill at levels three, seven, eleven and fifteen. All new skills start at level one proficiency.

- Communications: Any (+10%)
- Domestic: Any (+5%)
- Electrical: Any (+5%)
- Espionage: Any (+10%)
- Mechanical: Basic mechanics only (+5%)
- Medical: First aid only (+10%)
- Military: Any (+20%)
- Physical: Any
- Pilot: Any (+10%)
- Pilot Related: Any (+10%)
- Rogue: Any (+10%)
- Science: None

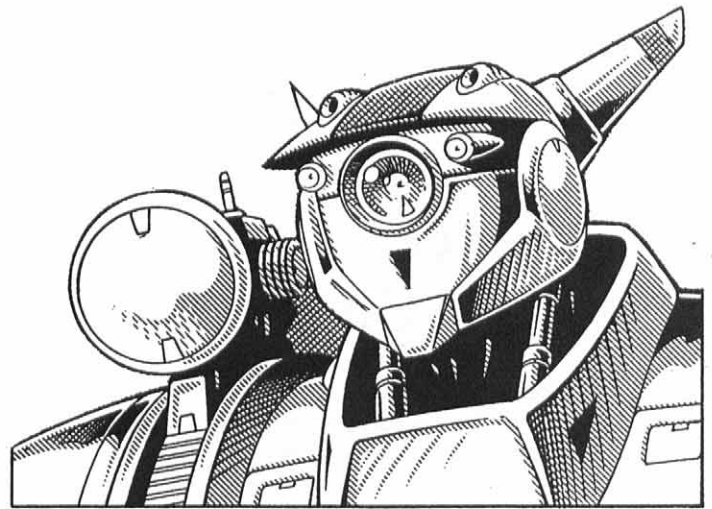

Technical: Any (+10%)

W.P.: Any

Wilderness: Any (+20%)

Secondary Skills: The character also gets to select two secondary skills from the list, excluding those marked "None," at levels two, four, eight, and twelve. These are additional areas of knowledge that do not get the advantage of the bonus listed in parentheses. All secondary skills start at the base skill level.

Standard Military issue for the Intelligence Commando: T-10 body armor and T-11 Enhanced body armor, energy rifle of choice, sidearm of choice, four extra energy clips for each, vibro-blade of choice, survival knife, 2 smoke grenades, 2 fragmentation grenades (2D6 M.D.), 2 plasma grenades (4D6 M.D.), hand-held computer, language translator, flashlight, distancing binoculars, canteen, utility belt, backpack, additional air filter and gas mask, walkie-talkie (when not in armor), two standard uniforms and one dress uniform.

Equipment Available Upon Assignment: Additional body armor, weapons and equipment, surveillance equipment, cameras, recording equipment, computers, sensory equipment, access to the T-Series power armor, X-10A Predator, X-60 Flanker, X-500 Forager, EIR-15 gargoyle bot, and other military vehicles or means of transportation. The character also has access to most military bases and facilities (high security clearance). **Note:** Availability of equipment and resources may be dependent upon the local commander, supply stock, location, casualties and combat conditions. The intelligence commando always has priority over power armor, body armor, S.C.U.B.A. equipment, heavy weapons, explosives, and cybernetic repairs, and weapons.

Money: A pair of intelligence commandos share a private, four bedroom apartment with a study, living room, kitchenette and two private bathrooms. This apartment is usually located on or near a military base. Or the character may pay for a private apartment in town, but is always near a military base.

The monthly salary is 2200 credits (the savings of a first level character is 2D4 × 1000 credits). High ranking officers (8th level and higher) get 4000 to 7500 credits a month.

Rank: Standard military rank; starts as a private.

Cybernetics and Bionics: Gyro-compass, clock calendar, universal headjack and ear with amplified hearing and an oxygen storage tank are standard to start. High ranking officers (8th level or higher) are likely to have the following additional implants: one or two cybernetic eyes (bio-system or cyber),

a bionic arm with two to four weapons or features and one cybernetic weapon or implant of choice. Other cybernetics can be purchased or awarded for acts of heroism, or provided for a specific mission.

Police O.C.C.

The NGR Law Enforcement Officer

All police officers, whether assigned to civilian or military duty, coordinate all operations with the military and use military personnel. The specialized training of the police O.C.C. character includes investigation, streetwise, urban combat, piloting the X-60 Flanker, X-10A Predator and X-535 Jager power armors.

Most NGR police officers are honest, caring, dedicated and well intentioned. Many will even try to give D-bees a fair shake, especially those who look relatively human. The most brutal police officers are those who believe in human supremacy — about 25%. These men and women look at all D-bees as suspects, criminals or worse. They tend to bend the rules, use unnecessary force, intimidation tactics and are brutal toward D-bees, D-bee supporters, city rats, and junkies. However, these brutes are not all evil (although many are), just misguided or bitter. Alignments of these police officers can include unprincipled, anarchist or aberrant. Those who are not just plain evil, exhibit surprising tenderness, understanding and mercy when dealing with humans, but can turn around and be incredibly brutal to non-humans.

Thankfully, only 8% of the police force is truly evil and/or corrupt. Corrupt officers take bribes, use force, steal when the opportunity avails itself, and are likely to work for or with criminals, illegal arms dealers, MOM shops, D-bees or the enemy. They may also engage in extortion, assassination, destruction of evidence, forgery, and information dissemination (sell info to crooks, even when it hurts a fellow police officer).

Administering Justice

Civilian Jurisdiction

The military is charged with civilian law enforcement, crime prevention, investigation, and the protection of the innocent.

Civilian and urban criminals (mostly humans), disturbances and crimes are under the jurisdiction of the local or federal court system. These suspects and criminals are arrested and delivered to the local judiciary where they are incarcerated, brought to trial, plead their case, and find justice. Crimes and punishment are very similar to those of the 20th Century. Justice in the cities and villages within the New German Republic is usually quick and fair.

The military soldiers assigned to maintaining law and order on the city streets must deal with all the usual maladies that plague any city. These include vandalism, mugging, robbery, assault, murder, civil disturbances, and many other criminal activities. The level of technology in the NGR means many perpetrators are heavily armed or are borgs, juicers, crazies, punks high on augmenting drugs or clad in power armor.

Criminals who fall under military jurisdiction are taken to a military base or prison and face military justice as an enemy soldier or spy.

Military Jurisdiction and Justice

In the world of Rifts Earth where the supernatural and magic are commonplace, the police find themselves facing confidence men, thieves, murderers and menaces who possess magic or psionic powers, summoners and witches with legions of monsters, as well as maniacs with magic weapons, potions and alien technology. Among their police duties are the hunting down and terminating of supernatural predators, invading monsters, marauding entities, and similar evildoers. Along these lines, they must learn to recognize demonic and psionic possession, mind control, illusions, and shape-changing monsters.

All supernatural monsters, enemy soldiers, enemy conspirators and D-Bees are enemies of the State, considered to be war criminals, and are left to the jurisdiction of the military. Other categories for war criminals or enemies of the NGR, human or monster, include ALL enemy soldiers, subversives, saboteurs, terrorists, spies, invading monsters, and unrecognized D-bees. Even if the inhuman suspect or criminal has no affiliation with the enemies of the NGR and is captured in the city for breaking the law, he must deal entirely with the military authorities. The civil authorities do not concern themselves with these criminals in any way and rarely intercede on their behalf. It is the military who tracks down the "enemy," captures them, conducts interrogations, sentences (trials may not apply) and punishes them. Punishment can include beatings, torture, deporting, imprisonment, and execution.

When dealing with these menaces, especially with demonic monsters and, to a lesser degree, all non-humans, the military and the police view them with extreme prejudice. Deadly force is considered reasonable even under the most auspicious of situations. The credos of the police and military when facing non-humans, especially monsters, are, "Take no chances," and "better them than us." Consequently, if a monster like a dragon, psistalker, simvan, gurgoyle, or werewolf (dog boys are frequently mistaken for werewolves), does not surrender immediately and tries to run away or resists arrest, the police will shoot to kill. Once such aggression has begun it is difficult to stop. As a result, the authorities may continue to beat up or kill the suspect even after he does finally surrender, or is arrested, or incapacitated. Even under the best of circumstances where the suspect submits completely and cooperates fully, the monster character is likely to be securely restrained, verbally abused, shoved around, beaten and treated like garbage. Sassing back or name-calling can only make the prisoner's treatment worse. If the character is later found to be innocent there is not likely to be an apology nor recompense for any injury or losses. He or she is lucky to be alive and set free.

Wilderness Justice

Justice in the villages and kingdoms outside the NGR can be brutal, if it exists at all. Often, wilderness justice belongs to the individual or group who is the strongest, meanest, or who simply got to the suspects first. Justice and fair play will vary widely depending on who is dispensing it. Even some soldiers in the NGR play fast and loose with morality, justice and mercy in the wilderness. The severity of mistreatment and injustice will also depend on the character(s), his alignment and the stress of the situation. Most humans are particularly cruel and intolerant of bandits, gypsies, D-bees, and supernatural monsters.

The Police O.C.C.

Attribute Requirements: I.Q. 8 and M.E. 10 or higher; a high I.Q., M.E., P.S. and P.P. are recommended but not mandatory.

O.C.C. Skills:

Literacy: Euro (+30%)
Language: Euro (+30%)
Language: Select one additional (+10%)
Radio: Basic (+10%)
Surveillance Systems (+10%)
Computer Operation (+10%)
Streetwise & Streetwise Drugs (both are +20%)
Intelligence (+10%)
Math: Basic (+20%)
Pilot Hover Vehicles (+10%)
Pilot Robots & Power Armor
Robot Combat Elite: X-60 Flanker
Robot Combat Elite: X-10A Predator Or X-535 Jager
Climbing (+5%)
Running
W.P. Automatic Pistol
W.P. Energy Pistol
W.P. Energy Rifle
Hand to Hand: Basic

Hand to hand: basic can be changed to expert for the cost of one "other" skill or to martial arts (or assassin if an evil alignment) at the cost of two "other" skill selections.

O.C.C. Related Skills: Select five other skills, plus select one additional skill at levels four, eight, and twelve. All new skills start at level one proficiency.

Secondary Skills: The character also gets to select two secondary skills from the list, excluding those marked "None," at levels one, three, seven and eleven. These are additional areas of knowledge that do not get the advantage of the bonus listed in parentheses. All secondary skills start at the base skill level.

Communications: Any (+10%)
Domestic: Any (+5%)
Electrical: Basic electronics only
Espionage: Disguise, sniper, tracking and wilderness survival only (+10%)
Mechanical: Basic and automotive mechanics only
Medical: Paramedic only (+5%)
Military: Any
Physical: Any, excluding acrobatics.
Pilot: Any (+15%)
Pilot Related: Any (+5%)
Rogue: Any (+5%)
Science: None
Technical: Any (+15%)
W.P.: Any
Wilderness: None

Standard Military issue for Law Enforcement Officers:

Choice of T-10 or T-12 (light grey color and no medic symbols) body armor, X-60 Flanker and/or hovercycle or hover pod, automatic pistol of choice (typically 9 or 10 mm), energy pistol of choice, energy rifle of choice (typically TX-42 or TX-16 pump rifle), billy club/riot club (1D6 S.D.C.), two pairs of handcuffs, two tear gas grenades, flashlight, distancing binoculars, utility belt, gun holster of choice (shoulder or waist), air filter and gas mask, walkie-talkie, portable language translator, four standard uniforms and one dress uniform.

Equipment Available Upon Assignment: Additional weapons, energy clips, and vehicles, T-40 "plain clothes" body armor, T-11 Enhanced body armor, X-10A Predator, X-535 Jager, medical kit, portable computer, cameras, surveillance equipment, and basic supplies. The police also have access to most police stations and the equipment stored there, access to police computers and data bases, access to low security clearance military computers, data and bases, and the use of local jails and prisons. **Note:** This equipment and resources are provided on an "as needed" basis. Availability may be dependent upon the commander, supply stock, location, casualties and combat conditions.

Money: The police officer gets a small, four room apartment in the city or village near his police station and local commander. Free meals are available at the cafeteria located at most major police stations; the food is reasonably good at most. Or the officer can get food at any of the military bases. Weapons, ammunition, vehicles and equipment are provided by the military.

The law enforcement officer also receives a monthly salary of 2500 credits (the savings of a first level character is 1D4×1000 credits). High ranking officers (9th level and higher) get 4000 credits a month. The pay may sound low, but this character is not concerned with money alone, like most soldiers in the NGR military, the police are concerned most with protecting their homeland.

Rank: Law Enforcement Officers (LEOs) have the same rank and command structure as the military, but the lowest rank given to Leos is corporal. The most common ranks are sergeant, lieutenant, detective lieutenant (police specializing in investigation) and captain.

Cybernetics and Bionics: None to start. Any cybernetic augmentations must be purchased or given as a reward for heroism. See the **Rifts RPG** and the cybernetic section in this book for the full range of available items.

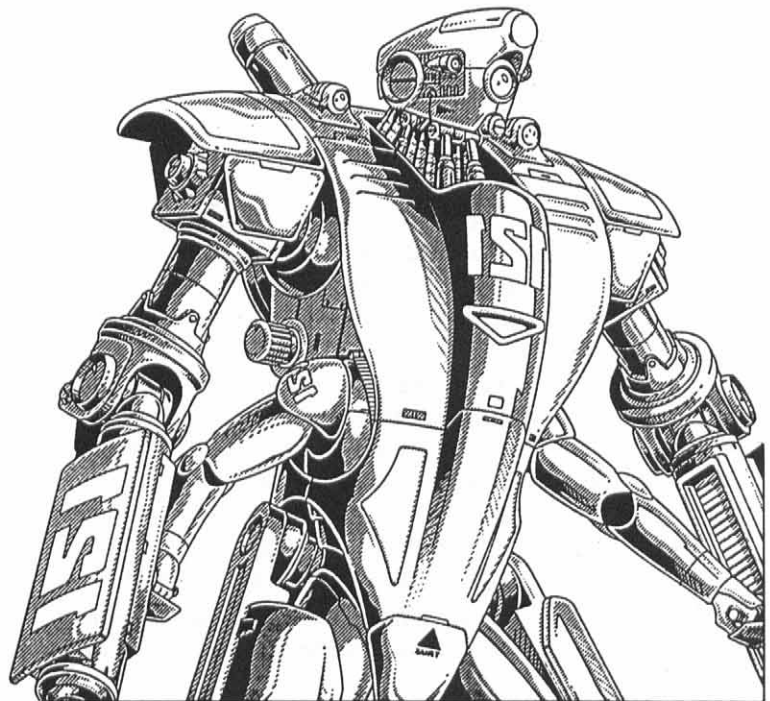

Non-Military O.C.C.s

Euro-Juicer O.C.C.

Juicer technology was originally developed by Pre-Rifts German chemical companies and flourishes in Rifts Earth and the NGR. Chemical augmentation is not illegal in the NGR, but it is not used by the military or Triax (both rely heavily on bionics and robotics) nor encouraged by the government.

The Juicer as a Player Character

The same creation considerations, conditions, skills, bonuses and penalties as described in the **Rifts RPG** are applicable to the NGR/European Juicer — create the character as usual. Most Juicers are adventurers, explorers, mercenaries or assassins for hire. Few are active soldiers in the NGR military or law enforcement.

A Drug Prevalent Society

The NGR and many European communities also have access to drugs and other juicer-like augmentation that is worth mentioning. However, even though these drugs and chemical augmentation are legal and available on the streets, especially in the industrial cities, they are not safe or even desirable. The NGR government spends a great deal of money on anti-drug advertising and rehabilitation clinics. In all cases, drug dependency is dangerous, addictive, has debilitating side effects and can cause permanent mental and/or physical damage.

The average citizen has been taught the hazards of the chemical augmentation and the vast majority (86%) avoid it. However, drug use for recreation, quick boosts, and **Juicer Technology** flourishes in and around the NGR. It is especially popular among mercenaries, city rats, bandits, foreign armies, foreign warriors and adventurers.

The JAEP System

Juicer Augmentation Enhancement Program

“Jape,” the slang for Juicer Augmentation Enhancement Program (JAEP), has become the latest fad among the wealthy, mercenaries, and adventurers. Jape is a full chemical system similar to the much more powerful and deadly Juicer system, complete with an internal bio-comp system and drug injection collar. This chemical augmentation system is somewhat less addictive, has fewer side effects, and is much less lethal than the full Juicer system. However, unlike full Juicer augmentation, which dramatically increases the character’s physical performance, the Jape program is narrowly focused, limiting its chemical augmentation to one particular area of enhancement.

A level of safety with JAEP

ANY human character from any O.C.C., other than Juicer, Robot, or Borg, can use JAEP. It is not recommended for use by characters who use bio-wizardry augmentation, MOM implants or who are psionic or alien life-forms. The promoters of Jape insist that it is “safe” when used in moderation and with

the proper controls in place. The recommended safe use of JAEP is a maximum of three months, followed by a three month break to get “clean” before either renewing the program or selecting a new JAEP category. However, JAEP has only been in service for ten years, not nearly enough time to determine the real dangers of addiction or long-term side effects.

Only one JAEP can be used at a time. Trying to use two different JAEP enhancements simultaneously will cause a drug overdose resulting in one or more (roll 1D4) of the following (G.M. selects): cardiac arrest, stroke, convulsions followed by paralysis, and/or permanent brain damage.

Taking street drugs while on JAEP is not recommended, can cause problems, but is seldom lethal. The combination of JAEP and other drugs will usually result in the penalties and negative symptoms of the street drug lasting twice as long. Sometimes the penalties are also twice as severe (G.M.’s discretion). Accidentally getting the wrong drugs for a different program while currently on JAEP will cause death or permanent brain damage. Fortunately, such incidents have been extremely uncommon, even when relying on criminal suppliers.

JAEP users who do not take the proper precautions and continuously use jape month after month without a break, will become as chemically, emotionally and physically dependent on the drugs as any juicer. JAEP is addictive and dangerous when used continuously for more than six months. The recommended three month “clean” period in between JAEPs is critical to avoid addiction. There is also evidence to suggest addiction by users who continually select the same JAEP enhancement over and over again, even with the three month “clean” period between each use. The only difference between the jape addict and a full juicer is that the character can live for decades, as long as he has a continual supply of drugs. The life expectancy of a JAEP addict is shortened to the age of 45 + 1D6 years. A normal NGR citizen has a life expectancy of 80. Juicers, by contrast, usually die within a decade or so after receipt of Juicer augmentation.

The good news is that a JAEP addict can get 100% clean and sober without side effects even after 10 years of constant use. However, after that period, the success ratio drops to 60% and all the same side effects and withdrawal conditions that apply to the Juicer apply to the Jape addict.

Side effects from long-term JAEP and other drug addictions: Roll percentile dice for random effects or make a selection (G.M.’s discretion).

01-15 Memory lapses (comes and goes): Penalties: – 10% on skill performance, tends to be habitually late by 1D6 × 10 minutes, and forgets dates and little, mostly insignificant details.

16-30 Always tired and sleepy: Sleeps 8 + 1D6 hours a day unless woken up by a very loud alarm clock or another person. The character also falls asleep when bored and is – 1 on initiative.

- 31-40** Trouble sleeping: Feels either fatigued or wired/hyper all the time. Seldom sleeps more than four hours a day. Penalties: -1 on initiative and -5% on all skill performance.
- 41-50** Develops a phobia: Make a random roll or pick one of the fears from the phobia insanity table. G.M.s may add new phobias if they desire to do so. Some likely candidates would include a fear of gargoyles/gurgoyles, brodkil, simvan, MOM conversion/implants, symbiotic organisms, dimensional rifts, and similar.
- 51-60** Develops an obsession: Make a random roll or pick one of the obsessions from the insanity table found in the **Rifts RPG**, page 20. G.M.s may add new obsessions if they desire to do so. Some likely candidates would include the love or hate of gargoyles/gurgoyles, brodkil, ugly D-bees/aliens, MOM conversion/implants, Juicers/drugs, bionics/borgs (hate is likely to be directed at monsters that use bionics), symbiotic organisms, dimensional travel/magic and similar.
- 61-70** Immune system is weakened: -1 to save vs magic and psionic attacks, -2 to save vs disease, poisons and other drugs, and -10% to save vs coma/death.
- 71-80** Dependent on other drugs or alcohol. See drug and alcohol addiction in the **Rifts RPG**, page 21.
- 81-90** Suffers from a constant headache that turns into a migraine 1D4 times a week, usually under stressful conditions. -1 on initiative, -1 on all combat skills, and -10% on skill performance. Double penalties during a migraine and reduce the character's spd attribute by 20%.
- 91-00** Periodic hallucinations: This can be very dangerous especially since they are frequently brought on by stress. A hallucination can occur randomly or whenever under severe stress like a big career move, people are counting on him/her, and life and death situations. The hallucinating character will see and hear things that will make him/her respond in ways inappropriate to the current situation. Reactions can be euphoria (happy and oblivious to the dangers around him), aggression/hate (shouts inflammatory remarks, insults and/or attacks), fear (screams, pleads for mercy, hides, or runs away), and similar. Exactly what hallucination he sees is up to the G.M. and/or player.

JAEP Enhancement Categories & Powers

Select only one JAEP (if any). Once selected, the user cannot change the JAEP until after a three month "clean" period. Although all JAEPs are designed for a period of three months, a user can get off the program at any time, but must wait three months before a new JAEP or Juicer augmentation can be performed.

Physical Enhancement: Steroids, hormones and other chemicals bulk up the muscles and increase the speed of reflexes. **Bonuses:** +6D6 to S.D.C.; +4 to P.S. and +2D4 to speed. The character is also +1 on initiative, +1 to strike, parry and dodge, and +2 to save vs disease, poisons and toxins. **Market Cost:** 125,000 credits. **Recommended length of the program:** Three months followed by three months of abstinence.

Speed Enhancement: Drugs that accelerate the metabolism and bulk up the muscles. **Bonuses:** +2D6 to S.D.C.; +1 to P.S., +1 to P.P. and +5D6 to speed. The character also gets one additional attack/action per melee round and is +2 to dodge, +2 to pull a punch and +2 to roll with impact. **Market**

Cost: 85,000 credits. **Recommended length of the program:** Three months followed by three months of abstinence.

Healing Enhancement: The character heals from injury and sickness twice as fast as normal. **Bonuses:** +5 to save vs disease, +3 to save vs poisons, drugs and toxins, and +10% to save vs coma/death. **Market Cost:** 85,000 credits. **Recommended length of the program:** Three months followed by three months of abstinence.

Mental Enhancement: Chemical stimulants and other drugs enhance the character's alertness and mental stamina. **Bonuses:** +2% on all skills, +2 on initiative, +1 to save vs psionic attack, +2 to save vs mind control drugs. Productivity is increased by 33%. **Market Cost:** 95,000 credits. **Recommended length of the program:** Three months followed by three months of abstinence.

Designer Drugs

In addition to the juicer technology, there are a number of drugs available on the streets. Street drugs are commonly available in prisons, big cities, among gang members, city rats and the poor. Many of the drugs that plagued Pre-Rifts society are still available in the Germany of the future. They include barbiturates, amphetamines, cocaine, painkillers and hallucinogens. The (fictional) designer drugs described in the following section are some of the more unique chemicals developed by the same people who created Juicer technology. These street drugs are listed by their "street" name.

Boing-go

A powerful stimulant that is roughly equal to drinking five pots of coffee and taking a hit of speed.

Duration: 24 + 2D6 hours per dose.

Bonuses: The user will not feel fatigued or the least bit sleepy and is +1 on initiative. The character is alert, energetic and will not (cannot) sleep for 24 + 2D6 hours. This means his level of productivity could be increased by three to four times when the characters works for a full 24+ hours.

Penalties: Hyper, fidgety and easily bored. Even if the character gets done with his work early and/or feels a need to sleep, he will be unable to do so until boing-go wears off. When the user finally comes off the high he will feel exhausted and need 10 hours of sleep. If forced to function without sleep the character will be in a daze: All combat bonuses, number of melee attacks, speed and skill proficiencies are reduced by half!

Level of Addictiveness: High.

Prolonged use of boing-go (one or more times a week for over a month) or frequent use (three or more times in a single a week) will lead to addiction, with the following penalties: An inability to sleep, annoying hyper-activity and fidgeting, difficulty concentrating (reduce skills by 5%), and dramatic weight loss despite the fact the user has a voracious appetite (loses 5 pounds/2.3 kg per week — no weight gains).

After a few months, the boing-go junkie will have a thin, frail appearance with dark bags around the eyes, and a sickly pale complexion. After the fourth month, the character will collapse from physical exhaustion and require detoxification treatment,

vitamins, food, forced rest and medical attention. A reformed junkie will become instantly hooked if the character ever takes the drug again.

Cost Per Dose: 20 to 50 credits.

Crash

This is a powerful combination of drugs that gives its user a feeling of power, strength and invincibility.

Duration: 1D4 hours.

Bonuses while under the influence: +1D4×10+10 S.D.C., +10 to P.E. (and all appropriate bonuses), +6 to P.S., +6 to speed, +1 attack/action per melee, +8 to save vs horror factor. In addition the character is bold, fearless and aggressive.

Penalties: The character is so bold, fearless and aggressive that he or she is easily enticed into pointless brawls, dangerous challenges and taking stupid risks — acting without thinking. Furthermore, the character is likely to ignore pain, injury and blood loss, putting his life in jeopardy. Frequently, the crash user will also drink enough alcohol to kill the average man, but made possible from increased physical endurance. Of course this only makes the crash after the high all the more painful.

While the drug is active the user feels like a superman, but when the high is over the character feels like garbage in a trash compactor — he “crashes” hard. It is the crash after the high from which the drug gets its street name.

The crash, symptoms & penalties: The character feels very nauseous and will vomit 1D4 times an hour for the next 2D4 hours. The slightest noise will make his head pound as if shot by a cannon. The ears ring, eyes water, vision is blurred, the character feels dizzy, cannot walk (or crawl) a straight line, and finds it impossible to concentrate. All he'll want to do is crawl into a corner and sleep.

Penalties include -70% on skill performance, -6 on initiative, and speed, melee actions and combat bonuses are reduced by half. The symptoms and penalties last for 24 hours; double if the user was also drinking or taking other drugs. After the first and worst 24 hours (48 hours if mixed with booze), the crash penalties are reduced by half but last another 24 hours. The character may also suffer from bruises, broken bones, and other injuries from stupid stunts and fights while high.

Level of Addictiveness: Minimum.

The crash after the high is so terrible that most intelligent people never touch the stuff again! Only the meanest or stupidest members of street gangs, bandits, bullies and addicts will use it on a regular basis.

Using crash more than twice a week will make the character an addict. Drug dependency makes the character use the drug on a daily basis, even when feeling terrible. After a while, the addict believes he is only useful when high. In some ways, this is true because when the addict crashes he is practically comatose! The penalties are -90% on skill performance, -10 on initiative, speed is reduced by 90%, melee actions reduced to one, and combat bonuses are reduced to zero. The symptoms and penalties last for 96 hours or until another hit of crash is taken. After six months the user can only function when high and the stress on the body is so great that the user could collapse from cardiac

arrest (01-50) or exhaustion (51-00; roll once at the beginning of every day). A cardiac arrest will mean coma and death unless the character receives immediate medical attention and at least six days of treatment in a hospital. Collapse from exhaustion will mean a coma-like sleep for 2D4 days (only a telepathic probe, mind link or psychic purification has any chance of waking him sooner). When the character finally awakens he craves food and a hit of crash.

Cost Per Dose: 100 to 200 credits.

Euphie

Euphie is short for “euphoria.” This drug makes the character feel happy, giggly and without a care, anger or fear in the world. Like the drug crash, this distorted sensation makes the character vulnerable to attack, injury and dangerous situations.

Duration: 1D4 hours.

Bonuses while under the influence: +3 to M.A. (and all appropriate bonuses), +5 to save vs horror factor, +2 to save vs illusion and empathic transmission, and +3 to roll with impact, punch or fall. In addition the character is completely relaxed, cheerful, friendly and fearless.

Penalties: The character is so relaxed, cheerful and fearless that he or she takes foolish risks and will not avoid dangerous situations. Furthermore, the character is likely to be oblivious to danger, injury and blood loss to himself or those around him. -4 on initiative and reduce the character's speed by 20%, attacks per melee are -1, and -20% on skill performance.

Level of Addictiveness: High.

Using euphie more than once a week will make the character an addict. Drug dependency makes the character crave the drug 1D4 times daily! The addict will suffer from the penalties listed above all the time, even when he's not high. After six months, the user cannot bear the idea of seeing/experiencing the world without euphie. He will avoid people and conflict except when high and will become paranoid about individuals who talk against euphie or drugs in general.

Cost Per Dose: 30 to 60 credits.

Psike-B

Psike-B is a strange combination of drugs that clouds the mind and affects psionic powers. The drug works like a mind block when used by non-psionic characters. Psike-B has a much more profound affect on psionic characters.

Duration: 1D6×10 minutes.

Bonuses while under the influence: The non-psychic user will find himself impervious to empathic and telepathic communication, mind bond, psionic possession and +1 to save vs other types of psionic attacks. The psionic character suffers only problems.

Penalties: To non-psionic individuals, the drug makes concentration and focus difficult. Generally speaking, the character will feel like he's drunk, cannot walk straight and suffers the following penalties: -30% on skills, loses track of time, and forgets details.

Psychic characters find their psionic powers blocked! They cannot use the simplest psi-power without intense concentration. Even then the use of the ability will cost twice the normal I.S.P. and the duration and range will be half. The drug also automatically triggers a mind block, preventing

empathic and telepathic communication whether the psychic wants it or not.

The character suffers from a pounding headache, involuntary twitching of one eyelid or cheek muscle, and memory loss. In this case, the memory loss is so severe that the psychic will forget his name, much of his past, most of his friends, skills (01-50% has forgotten a specific skill, 51-00 means the skill is remembered but impaired, -30%), and completely lose all sense of direction and time. Attacks per melee and all combat bonuses are reduced by half. Thankfully, memory, powers and skill performance all return when the drug wears off.

Level of Addictiveness: Medium.

Psionic characters avoid the drug because of its detrimental effects.

Non-psionics using psike-B more than four times a week will become addicts. Drug dependency makes the character crave the drug 1D4 times daily! The addict will have all the bonuses and penalties listed above. After the high the user will remain penalized but only by half.

Cost Per Dose: 25 to 50 credits.

Psike-E

For the average person, psike-E is a mild hallucinogenic and a minor euphoric. However, it has a much more profound affect on psionic characters.

Duration: 2D4 × 10 minutes.

Bonuses while under the influence: The duration and range of psionic powers are increased by 50%, the psychic character is +2 to save vs most psionic attacks and he can sense/detect other psionic characters and see their auras!

Penalties: The psychic under the drug's influence is -5 to save vs mind control and possession, -10 to save vs magic illusions and other hallucinogens, is disoriented (-20% on skill performance), and loses his sense of time. The psychic under the influence also tends to be dazed and slow to react (-1 on initiative and loses one melee action). After the drug wears off, the recollection of events that occurred while high are foggy and incomplete. Psionic character may (01-50% chance) also have one or two drug induced hallucinations (happy or frightening) while high.

Level of Addictiveness: Medium.

Most psionic characters avoid the drug because it is more debilitating than it is helpful. Using psike-E more than four times a week will make the character an addict. Drug dependency makes the character crave the drug 1D4 times daily! The addict will have all the bonuses and penalties listed above. After the high the psychic will remain dazed and slow to react to things around him.

Cost Per Dose: 30 to 75 credits.

Rush

Rush is another combination of drugs that heighten the user's senses, speed and reflexes.

Duration: 1D6 × 10 minutes.

Bonuses while under the influence: Add one additional melee attack, +3 on initiative, +1 to strike, +2 to parry and dodge, +3 to roll with impact, and +10 to speed attribute. General skill performance is increased by +5% and +10%

on skills requiring dexterity and control such as surgery, forgery, lock picking, piloting, acrobatics, gymnastics, climbing and juggling. In addition the character is keenly aware of his five senses, particularly smell, taste, hearing and touch.

Penalties: Bad and good smells are twice as potent, a lot of different sounds jangle the nerves and disrupts concentration (-10% on skill performance), and the character tends to be irritable and cranky.

Level of Addictiveness: Medium.

Using rush more than four times a week will make the character an addict. Drug dependency makes the character crave the drug 1D4 times daily! The addict will have all the bonuses listed while high, but becomes so emotionally dependent on it that he thinks he is clumsy and incompetent without it. When not high the character is minus one melee attack, -3 on initiative, -2 to strike, -3 to parry and dodge, -3 to roll with impact, -10% on skill performance, and the speed attribute is reduced by 20%. In addition the character's senses seem (it's all psychological) dulled. Food and drinks taste bland, the hands seem clumsy and cold, sounds seem muffled and odors smell unusual.

Cost Per Dose: 50 to 100 credits.



Gypsy O.C.C.s

Whatever one thought of Pre-Rifts gypsies, the nomads of Rifts Earth are a completely different lot. About 50% of the gypsies are human, 40% D-bees and 10% supernatural monsters or aliens. Gypsies are wanderers who have no one place they call home and many don't have any idea of their heritage. They are most common in Central Europe (Germany, Poland, Hungary, Romania, western Russia and the other old Slavic countries), but can be found in Greece and other Mediterranean countries, and as far east as Mongolia and northern China.

Most gypsy "clans" are composed of several related families and people accepted into the clan. Ironically, gypsy clans seldom squabble among themselves or steal, cheat, plunder or lie to each other. It's as if the hundreds of gypsy clans are all part of a giant fraternity and all the members of the fraternity regard each other as brothers to be treated with respect and kindness. Like any fraternity, gang, or secret society, the gypsies wear identifying "color" in the way of bright bandannas and scarves (usually shades of yellow, orange, red, pink and purple) and have a secret language known only to true gypsies. The gypsies' language is never spoken in front of non-gypsies, let alone taught to strangers. They also have a love for gold and jewelry.

Most civilized communities consider gypsies to be nothing but brigands, con-artists and thieves. Civilized and hard working people spit at the mention of gypsies and lament that they are nothing but thieves, too "lazy" and "shiftless" to work for a living, or to learn how to build things for themselves. The gypsies perpetuate this myth with their devil-may-care attitude, flip words and total disregard for authority and power. If you ask a gypsy why he doesn't settle down and get "respectable" work, he or she will flash a charming smile, blow a kiss in the air, and say, "Oh, Cheri, I hate dirt under my fingernails," or "I find sweating so unattractive. Don't you?" or "I am too beautiful to ruin my skin in the sun or cripple my body with labor, don't you agree?" and similar retorts.

Regarding the use of tricky, ambushes, traps, blackmail and theft, rather than stepping boldly forward and "fighting like a man," the gypsy will look at his accuser with a quizzical smile and mock surprise or concern in his voice and say something like, "Fight like a man?! I am a lover not a fighter." They seem to have a million snappy comebacks for every remark. Worst of all, gypsies always seem to be enjoying themselves and usually deliver the punch-line with a cheerful smile, happy tone and in a very deliberately condescending way — something that drives authority figures to distraction! Of course this attitude can get the character into more trouble than he's already in.

Laziness has nothing to do with the gypsies' conduct or work ethics. It's not that they can't learn to make things or grow crops, it's that they choose not to do so. Gypsies are very resourceful, cunning and capable people who have chosen to live as thieves and confidence artists. They love the excitement, intrigue and challenges of living by their wits and conning others to get what they want. A travelling clan is usually extremely organized, prepared for all possibilities and ready to move on a moment's notice. They are infamous for erecting elaborate gypsy villages of wagons, tents and vehicles. These travelling villages may seem fairly large, contain over two hundred residents, and reasonably entrenched. Yet they can vanish with little trace overnight (actually in less than an hour).

The gypsies of Rifts Earth regard all other life forms as prey. Not prey in the hunt, kill and eat sense, but in the hunt, trap and plunder sense. They survived the hardships of the Great Cataclysm and adapted to life in Rifts Earth as scavengers and thieves, taking what they need and want from others, rather than making it themselves. Furthermore, gypsies refuse to acknowledge the laws and boundaries of man and monster. They are anarchists who go where they please, do what they please, and stay as long as they desire (or until driven out). They are perfectly content to live in the wilderness, wandering from place to place and replenishing dwindling supplies by taking what they need from others. Not taking in combat and conquest, but by theft, gambling, cheating, and trickery.

The arrival of a gypsy caravan or even a lone individual can only mean trouble. When valuables disappear, the gypsy will be the first suspect (and is probably guilty). In addition to the commonplace robbery, theft and mugging, the gypsy likes to engage in elaborate schemes, charades and deceptions. They use disguises, forgery, distractions, magic illusions, mirrors, smoke, sex, children and every con-game and trick in the book to get the job done. Many clans will arrive with the fanfare of a carnival, pitch camp on the outskirts of town and offer fortune-telling, healers, magic shows, minstrels, dancing girls, and sell alleged magic potions, teas, elixirs and assorted other odds and ends. Whatever one buys from gypsies, the buyer must beware. The item, whether it be jewelry, a weapon or a magic potion, may or may not be authentic.

These masterful con-artists also use every transaction and conversation to get information and size-up the person, his friend or town for plundering or other schemes that will work to the gypsies' favor. For example: A beautiful gypsy woman might get involved with the chief of police or magistrate in order to get information about police raids and to influence his decisions or response time. Likewise, a pair of young gypsy lads may offer to carry heavy packages to a person's home for no charge, simply out of kindness. An apparent act of charity, but their real purpose is to learn where this "wealthy" person lives and size-up his or her house so some more experienced thieves can come rob the person later that night. If a villager is seen bragging about how much money he has won from some gypsy game or at gambling, you can be certain that he was allowed to win so that others would try their hand, only to lose their shirts. Just a streak of bad luck with a little helping hand from crafty cheating. Similarly, during dances and shows, pick pockets will work the crowd, plucking whatever easy valuables they can lay their hands on. After a big haul, they disappear into the night, before too many people realize they were robbed and send for the authorities.

Not all gypsies are this blatant. Many are much more discrete so that they will be welcomed the next time they visit. These gypsies will probably make most of their money from selling fortunes, healing remedies, magic potions, moonshine, trinkets and services like dancing, healing and sexual favors.

The gypsy's secret language is a spoken one, but it does have a dozen simple symbols that mean one of following: Danger, hide, safe/good, moved/travelling, valuable, steal, magic, friend, enemy, monster, vampire and illusion/false. All gypsies

also speak Euro and two or more others languages fluently, but only 20% are literate in any language.

Game Master Note: The rules for travelling shows and carnivals found in *Rifts World Book One: Vampire Kingdoms*, can be a valuable and fun aid when incorporating gypsy troublemakers and villains. Also note that vampires plague parts of Europe (like Romania) and may work with unscrupulous gypsies or prey upon clans.

The following gypsy Occupational Character Classes (O.C.C.) reflect a few of the more unique and specifically gypsy occupations. A gypsy can also be a headhunter, juicer, vagabond, wilderness scout, witch, traditional mystic, mind melter and any of the psychic R.C.C.s. Remember, being a gypsy is a lifestyle not a racial factor. A gypsy will not consider pursuing O.C.C.s like soldier, knight, techno-wizard, druid, scholar/teacher or similar O.C.C. because they are too disciplined and don't fit well into gypsy society. Most gypsies avoid cybernetics, power armor, robots and formal training in magic.

Gypsy Thief O.C.C.

The gypsy thief is a thug, cat-burglar, and con-man all rolled into one. Some are slimy little weasels or mean looking punks. Others are suave, bold, James Bond types. Regardless of how the thief may look or act, timid or bold, crude or debonair, male or female, all are master thieves!

Attribute Requirements: P.P. 12 or higher. A high I.Q., M.A. and P.E. are helpful but not a requirement.

Alignment Limitations: Unprincipled, anarchist or any evil. A thief cannot be of a good alignment.

O.C.C. Skills:

- Basic Math (+20%)
- Language: Gypsy (98%)
- Language: Select three of choice (+20%)
- Streetwise (includes Streetwise: Drugs, both are +14%)
- Horsemanship (+20%)
- Play Musical Instrument: One of choice (+10%)
- Dance (+15%)
- Concealment (+10%)
- Palming (+20%)
- Pick Locks (+15%)
- Pick Pockets (+15%)
- Escape Artist (+20%)
- Acrobatics
- Climbing (+10%)
- Prowl (+10%)
- W.P.: Choice of two
- Hand to Hand: Basic

Hand to hand: basic can be changed to expert at the cost of one "other" skill. Hand to hand: expert (or assassin if evil) can be taken for the cost of two "other" skill selections.

O.C.C. Related Skills: Select six other skills from any of the available skill categories. Plus select one additional skill at levels three, six, nine, and twelve. All new skills start at level one proficiency.

Communications: Radio: basic, radio: scramblers & optics only (+5%)



Domestic: Any (+10%)

Electrical: None

Espionage: Disguise, forgery, intelligence, and wilderness survival only (+10%)

Mechanical: None

Medical: First aid only (+5%)

Military: None

Physical: Any, excluding wrestling and gymnastics.

Pilot: Any (+10%), except robot combat: elite, tanks & APCs, jets, jet fighters, and ships.

Pilot Related: Any

Rogue: Any (+10%)

Science: None

Technical: Any (+10%; languages +15%)

W.P.: Any

Wilderness: Any (+10%)

Secondary Skills: The character also gets to select three secondary skills from the list, excluding those marked "None," at level one and one additional skill at levels four, seven, ten and thirteen. These are additional areas of knowledge that do not get the advantage of the bonus listed in parentheses. All secondary skills start at the base skill level.

Standard Equipment: Flashy clothes, including leather jackets, boots and gloves, light mega-damage body armor or T-40 "plain clothes" armor, bright colored bandanna, bright colored scarf, sunglasses or tinted goggles, energy rifle, energy pistol, pair of knives, lock picking tools, knapsack, backpack, 1D4 small pouches or sacks, canteen, binoculars, magnifying glass, pocket flashlight, large flashlight, 50 feet (15.2 m) of light cord and grappling hook, note pad or sketch book, 1D4 pens/markers or pencils. A horse, robot horse, hovercycle or land buggy are the character's choices for a vehicle (pick one). **Note:** All gypsies are snappy and stylish dressers. Thieves tend toward black and dark blue colors with splashes of golds and reds. They love leather.

Notable additional Equipment that a thief may want to acquire includes special clothing with concealed pockets, weapons and items with false (hollow) handles and bottoms, disguises, a better or alternative vehicle, jet pack, magic items, additional weapons, vibro-blade, laser scalpel, signal flares, smoke grenades, tear gas grenades, mini-tool kit, multi-optic bands, handcuffs, surveillance items, pocket mirror, pocket laser distancer, pocket digital disc recorder/player for recording his observations, and a hand-held computer.

Money: Starts with $1D4 \times 1000$ in credit and $2D4 \times 1000$ in jewelry, artifacts and other stolen goods. The gypsy enjoys the good life and tends to spend his money quickly and freely on life's many pleasures and extravagances.

Cybernetics: Starts with none. Most gypsies will avoid getting cybernetics except for medical reasons.

Gypsy Wizard Thief O.C.C.

The wizard thief is fundamentally a ley line walker with an emphasis on magic that is useful in thievery. Unlike the traditional line walker, the wizard thief usually has much less understanding of magic and a narrower band of spell knowledge. This is because the character is a thief first and a wizard second. The art of mystic thievery is traditionally passed down from father to son (or daughter). Since the main interest is stealing, the focus of the magic is almost entirely aimed in that direction. The wizard thief seldom even considers learning other areas of magic. Consequently, their spell knowledge will reflect their thief orientation and is limited to what poppa could teach. Typically most of the character's spells will be of the type that cause illusion, deception, confusion and concealment. The wizard thief progresses in experience at a slower pace because the character is fundamentally a split-class and focuses much of his training and attention on thievery and street-smarts rather than magic.

Wizard Thief Abilities

1. **Sense ley lines and magic energy:** The ability to sense whether a ley line or nexus is nearby. Identical to the line walker O.C.C.; see **Rifts RPG**, page 83.
2. **Read Ley Lines:** The power to instantly know the direction, length, nexus locations, and similar things about the ley line. Identical to the line walker O.C.C.; see **Rifts RPG**, page 83.
3. **Ley Line Transmission:** The ability to send a verbal and/or visual message along a ley line. Identical to the line walker O.C.C.; see **Rifts RPG**, page 83.
4. **Ley Line Phasing:** The power to instantly teleport from one place to another on the same ley line. Identical to the line walker O.C.C.; see **Rifts RPG**, page 83.
5. **Initial Spell Knowledge:** At level one experience, the character knows the following spells:
 - Blinding Flash
 - Globe of Daylight
 - See the Invisible
 - Chameleon
 - Concealment
 - Detect Concealment

Charismatic Aura
Mask of Deceit
Fool's Gold
Escape
Energy Disruption
Levitation
Armor of Ithan
Repel Animals
Reduce Self
Teleport: Lesser

The character can also select a total of four additional spells. The spell selections can be made from levels 1-4.



6. **Learning New Spells:** Additional spells and rituals of any magic level can be learned and/or purchased at any time regardless of the character's experience level. See *the Pursuit of Magic* in the **Rifts RPG**, page 164. Just remember that the wizard thief will select magic that will aid him in his pursuits as a *thief*, not mystic power.
7. **Magic Bonuses:** +2 to save vs horror factor, +1 to save vs magic, +1 spell strength at levels three, seven, ten and thirteen.
8. **P.P.E.:** Like all practitioners of magic, the wizard thief is a living battery of mystic energy that he can draw on to create magic. The character's permanent P.P.E. base is $2D4 \times 10$ plus the thief's P.E. attribute. Add $2D6$ P.P.E. per level of experience.

Note: The wizard thief does not have the line walker's powers of line drifting, ley line rejuvenation, or ley line observation ball.

Attribute Requirements: I.Q. 10, M.E. 12 or higher; a high P.P. (12 or better) is ideal but not mandatory. Only 50% of the wizard thieves are literate in any language.

Alignment Limitations: The character must be unprincipled, anarchist or evil. A thief cannot be of a good alignment.

O.C.C. Skills:

- Basic Math (+20%)
- Lore: Demons & Monsters (20%)
- Lore: Faeries (15%)
- Dance (+15%)
- Play Musical Instrument: One of choice (+5%)
- Language: Gypsy (98%)
- Language: Euro (+30%)
- Language: Select three of choice (+20%)
- Streetwise (+10%)
- Palming (+10%)
- Pick Pockets (+5%)
- W.P.: One of choice
- Hand to Hand: Basic

Hand to hand: basic can be changed to expert at the cost of two "other" skills, or increased to martial arts (or assassin if evil) for the cost of three "other" skill selections.

O.C.C. Related Skills: Select five other skills from any of the available skill categories. Plus select one additional skill at levels three, six, nine, and twelve. All new skills start at level one proficiency.

Secondary Skills: The character also gets to select two secondary skills from the list, excluding those marked "None," at levels two, five, eight, and twelve. These are additional areas of knowledge that do not get the advantage of the bonus listed in parentheses. All secondary skills start at the base skill level.

- Communications: Any (+5%)
- Domestic: Any (+10%)
- Electrical: None
- Espionage: Disguise, forgery, intelligence, and wilderness survival only (+10%)
- Mechanical: None
- Medical: First aid only (+5%)
- Military: None
- Physical: Any, excluding boxing, wrestling and acrobatics.
- Pilot: Any (+10%), except robot combat: elite, tanks & APCs, jets, jet fighters, and ships.
- Pilot Related: Any
- Rogue: Any (+5%)
- Science: Any (+10%)
- Technical: Any (+10%; literacy and languages +15%)
- W.P.: Any
- Wilderness: Any (+5%)

Standard Equipment: Cloak or cape (with or without a hood), a set of clothing, a set of traveling clothes, light mega-damage body armor or T-40 "plain clothes" armor, bright colored bandanna, bright colored scarf, stylish gloves, sunglasses, energy rifle or pistol, pair of knives, knapsack, backpack, 1D4 small pouches or sacks, six wooden stakes and a mallet, wood or silver cross, canteen, binoculars, magnifying glass, pocket flashlight, large flashlight, 50 feet (15.2 m) of light cord and grappling hook, note pad or sketch book, 1D4 pens or pencils. A horse, or robot horse, or hovercycle or land buggy are the character's choices for a vehicle. **Note:** All gypsies are snappy and stylish dressers and their choice of garments will reflect their boldness and bright personalities.

Notable additional Equipment that a wizard thief may want to acquire includes magic weapons, magic potions, magic equipment, scrolls, vibro-blade, laser scalpel, signal flares, smoke grenades, tear gas grenades, mini-tool kit, multi-optics band, handcuffs, surveillance items, pocket mirror, pocket laser distancer, pocket digital disc recorder/player for recording his observations, and a hand-held computer.

Money: Starts with 1D6 × 1000 in credit and 3D4 × 1000 credits worth of jewelry, artifacts and other stolen goods. The gypsy enjoys the good life and tends to spend his money quickly and freely on life's many pleasures and extravagances.

Cybernetics: Starts with none and will avoid getting cybernetics except for medical reasons. He may consider bio-wizardry items.



LONG

Gypsy Seer O.C.C.

The gypsy seer may call himself a fortune-teller but he or she is much more. They are a variation on the mystic. Exactly why this variant mystic is common only among the gypsies of Europe and the oracles of China remains a mystery. Like the traditional mystic, this character possesses both psionic and magic powers. The character is born with these powers so the seer needs no formal education and does not study magic. As young as age five, the psionic powers start to manifest themselves. After puberty, around age 14, the gypsy seer will suddenly know some spell magic, including the oracle spell.

The seer just accepts his powers as a gift of nature. The intuitive nature of the character's powers tends to give him or her a spiritual or metaphysical perspective of life. They trust feelings and dreams, see signs of good luck or bad omens, read palms, see the future and sense danger.

The Psionic Powers of a Gypsy Seer

1. **Sense Supernatural Evil:** The seer is keenly aware of the supernatural world around him/her. As a result, the character can sense the presence of supernatural evil forces. **Range:** 300 feet (91.5 m) plus 20 feet (6 m) per level of experience.

The seer can also sense the approach of great evil, including a supernatural, alien intelligence, gods, demon lords, or an invading army of monsters or humans. The ability will come as a feeling of dread and as prophetic dream at least 72 hours in advance of the real danger. Frequently, the warnings and dreams come weeks in advance.

2. **Read Palms:** The seer can tell a lot about a person by looking at the character's palms. In many respects, this power is a sort of acute clairvoyance and see aura rolled into one.

By looking at a person's palm, the seer can see the following:

- Estimate the person's alignment.
- Tell if the character is filled with hate or happiness.
- Tell whether he or she is troubled by something or afraid.
- Tell whether or not the character is sick or addicted.
- Tell whether or not the character is hunted.
- Tell whether or not the character is in love.
- Whether he or she is possessed.
- Recognize the sign of evil; i.e. recognize vampires, werebeasts, and demon shape changers like the succubus, incubus, dybuk, and other supernatural beings who can perform metamorphosis into human form. This ability does not include humans transformed by metamorphosis spell magic, changelings or dragons.
- Estimate age to within 2D4 years. This means the seer can recognize creatures who are hundreds or thousands of years old even though they may look completely human.
- Sense the presence of psionic powers.
- Sense high P.P.E. (20 or more points).
- Estimate the general level of experience. Low (1-3), medium (4-7), high (8 and up).
- Estimate the general alignment, i.e. good, selfish, or evil.

Note: By using his/her power of clairvoyance while holding the person's palm, the seer may glimpse that person's possible future. The impression is usually vague, like, "I sense danger" or good fortune", or "you find what you are looking for," or "you will be challenged," or "you will have to make an important decision." The seer's insight is usually based on events already in motion and that are likely to transpire within the next eight weeks. Occasionally, the seer will actually see an image of some future event involving the character (G.M.'s discretion).

3. **Other, more common psionic powers automatic to the gypsy seer:** Clairvoyance, object read, presence sense, sixth sense, see aura, mind block auto-defense and hypnotic suggestion.

At experience levels two, four, seven, ten, and thirteen the character can select one additional psionic power from the categories of sensitive or healing.

4. **I.S.P.:** Roll $1D6 \times 10$ plus the character's M.E. number to determine the base Inner Strength Points (I.S.P.). The seer gets an additional 10 I.S.P. per level of experience.
5. **Saving throws versus psionic attack:** The gypsy seer is considered to be a master psionic and saves on a roll of 10 or higher and is +5 to save vs possession and insanity.

Magic Powers

1. **Initial Spell Knowledge:** At level one experience, the character knows oracle, exorcism, see the invisible, and death trance.
2. **Learning New Spells:** The seer intuitively knows a couple of new spells as he reaches each new level of experience.

At second level he learns tongues and one spell of choice from level one and two spells.

At third level he learns Eyes of Thoth and one spell of choice from level one and two spells.

At fourth level he learns commune with spirits and one spell of choice from levels 1-3.

At fifth level he learns calling and one spell of choice from levels 1-4.

At sixth level he learns protection circle: simple and superior and one spell of choice from levels 1-5.

At seventh level he learns dispel magic barrier and one spell of choice from levels 1-6.

At eighth level and each subsequent level of experience the character can select a total of two new spells from levels 1-8.

3. **Magic Bonuses:** +4 to save vs horror factor, +2 to save vs magic, +1 spell strength at levels three, seven, ten and thirteen.
4. **P.P.E.:** Like all practitioners of magic, the seer is a living battery of mystic energy that he can draw on to create magic. The character's permanent P.P.E. base is $1D6 \times 10$ plus the seer's P.E. attribute. Add $1D6$ P.P.E. per level of experience.

Attribute Requirements: M.E. 14 or higher; a high I.Q. and M.A. are helpful but not mandatory. Only 10% of the gypsy seers are literate in any language.

Alignment Limitations: None. Can be any alignment.

O.C.C. Skills:

- Basic Math (+20%)
- Lore: Demons & Monsters (20%)
- Lore: Faeries (15%)
- Dance (+15%)
- Sing (+10%)
- Play Musical Instrument: One of choice (10%)
- Language: Gypsy (98%)
- Language: Euro (+30%)
- Language: Select three of choice (+20%)
- Wilderness Survival (+20%)
- Streetwise (+16%)
- Palming (+10%)
- Concealment (+6%)
- W.P.: One of choice
- Hand to Hand: Basic

Hand to hand: basic can be changed to expert at the cost of two "other" skill, or increased to martial arts (or assassin if evil) for the cost of three "other" skill selections.

O.C.C. Related Skills: Select four other skills from any of the available skill categories. Plus select one additional skill at levels three, six, nine, and twelve. All new skills start at level one proficiency.

Secondary Skills: The character also gets to select two secondary skills from the list, excluding those marked "None," at levels two, five, eight, and twelve. These are additional areas of knowledge that do not get the advantage of the bonus listed in parentheses. All secondary skills start at the base skill level.

Communications: Any (+5%)

Domestic: Any (+10%)

Electrical: None

Espionage: Any (+5%)

Mechanical: None

Medical: First aid or Holistic medicine only (+5%)

Military: None

Physical: Any, excluding boxing, wrestling, gymnastics & acrobatics.

Pilot: Hover vehicles, automobiles, horsemanship, and boats (+10%) Pilot Related: Any

Rogue: Any (+4%)

Science: Any (+10%)

Technical: Any (+10%)

W.P.: Any

Wilderness: Any (+5%)

Standard Equipment: Hooded cloak or robe, a set of clothing, a set of traveling clothes, light mega-damage body armor, Millennium Tree leaf armor, or T-40 "plain clothes" armor, bright colored bandanna, bright colored scarf, energy rifle or pistol, walking stick or staff, a knife or sling, knapsack, backpack, 1D4 small pouches or sacks, six wooden stakes and a mallet, a silver cross, squirt gun filled with water, a canteen filled with holy water, canteen for drinking water, pocket flashlight, note pad and sketch book, pocket digital disc recorder/player for recording his dreams and observations, 1D4 writing implements. A horse, or car or hover vehicle but only if the character can drive. **Note:** Of all the gypsies, the seer dresses the most demure. However, the character is likely to wear 2D4 rings, bracelets, necklaces, pins, earrings and other jewelry.

Notable additional Equipment that a seer may want to acquire includes magic jewelry/crystals, staves and wands, magic potions, herbs, demon slaying weapons/magic, and other types of exotic jewelry, weapons and objects. Sensory equipment, hand-held computer, language translator, cameras and recording equipment may also be of interest.

Money: Starts with 2D6 × 1000 in credit and 3D4 × 1000 credits worth of gold, jewelry, and artifacts. The gypsy enjoys the good life and tends to spend his money quickly and freely on life's many pleasures and extravagances.

Cybernetics: Starts with none and will avoid getting cybernetic except for medical reasons. The character may consider bio-wizardry items.



LONG

Gypsy — The Gifted O.C.C.

"The Gifted" or "The Gifted Ones" are gypsy healers. This character will have both psionic healing abilities and knowledge in the ways of medicine and herbology. They are among the most revered of the gypsies and often hold a high place among the clans. The Gifted tend to be the least violent and have few thief/rogue skills.

Psionic Powers

Randomly roll or select one of the following:

01-25 Major psionic: Select a total of 6 powers from any two psionic power categories (limited to healing, sensitive, and physical). I.S.P.: 1D4 × 10 plus M.E. number. Add 1D6 + 1 I.S.P. for each level of experience. Bonuses: +2 to save vs disease and poison, +1 to save vs magic, +1 to save vs magic sickness and curses, and +2 to save vs horror factor.

26-50 Major psionic: Select 8 powers from the healing category. I.S.P.: 1D4 × 10 plus M.E. number. Add 1D6 + 1 I.S.P. for each level of experience. Bonuses: +3 to save vs disease and poison, +1 to save vs magic, +2 to save vs magic sickness and curses, and +3 to save vs horror factor.

51-75 Master psionic: Select five healing powers, two sensitive powers, two physical powers, the super psionic power of bio-regeneration and a super psi-power of choice. At levels four, seven, ten and 13, the character can select one additional super psionic power or two lesser psi-powers from any of the three categories. I.S.P.: 2D6 × 10 plus M.E. number. Add

10 I.S.P. for each level of experience. **Bonuses:** +2 to save vs disease and poison, +1 to save vs magic, +1 to save vs magic sickness and curses, and +3 to save vs horror factor.

76-00 Master psionic: Select all healing powers and four super psionic powers of choice. At levels two, four, six, nine and 12, the character can select one additional super psionic power or two lesser psi-powers from any of the three categories. **I.S.P.:** 2D6 × 10 plus M.E. number. Add 10 I.S.P. for each level of experience. **Bonuses:** +4 to save vs disease and poison, +1 to save vs magic, +2 to save vs magic sickness and curses, and +4 to save vs horror factor.

Attribute Requirements: M.E. 14 or higher; a high I.Q. and P.P. are also ideal but not mandatory. Less than 5% of The Gifted are literate in any language.

Alignment Limitations: None. Can be any alignment.

O.C.C. Skills:

Basic Math (+10%)

Language: Gypsy (98%)

Language: Euro (+30%)

Languages: Select two of choice (+20%)

Streetwise & Streetwise: Drugs (both are +20%)

Dance (+20%)

Cook (+20%)

Preserve Food (+20%)

Identify Plants & Fruits (20%)

Biology (+20%)

Pathology (+20%)

Medical Doctor (+15%)

*Holistic Medicine (+30%)

W.P. Knife

W.P. Targeting (typically throwing knives and sling)

Hand to Hand: Basic

* **Note:** With the Game Master's approval, the holistic medicine skill can include the skills and powers of the herbalist/herbology skill as presented in **Rifts World Book Three: England**, including making curative teas and potions. The character also relies on his or her own psionic healing powers and abilities.

Hand to hand: basic can be changed to expert at the cost of two "other" skills, or increased to martial arts (or assassin if evil) for the cost of three "other" skill selections.

O.C.C. Related Skills: None if a master psionic. Select four "other" skills from any of the available skill categories if a major psionic. Plus select one additional skill at levels three, six, nine, and twelve. All new skills start at level one proficiency.

Secondary Skills: The character also gets to select two secondary skills from the list, excluding those marked "None," at levels two, four, eight, and twelve. These are additional areas of knowledge that do not get the advantage of the bonus listed in parentheses. All secondary skills start at the base skill level.

Communications: Any (+5%)

Domestic: Any (+10%)

Electrical: None

Espionage: Any (+5%)

Mechanical: None

Medical: See O.C.C. skills

Military: None

Physical: Any, excluding boxing, wrestling, gymnastics & acrobatics.

Pilot: Hover vehicles, automobiles, horsemanship, and boats (+10%) Pilot Related: Any

Rogue: Any

Science: Any (+10%)

Technical: Any (+15%)

W.P.: Any

Wilderness: Any (+10%)

Standard Equipment: Hooded cloak or robe, medical gown, a set of fancy clothing, a set of traveling clothes, light mega-damage body armor, Millennium Tree leaf armor, or T-40 "plain clothes" armor, bright colored bandanna, bright colored scarf, weapon of choice, sling, a pair of throwing knives, large knife, small hand axe, scalpels, knapsack, backpack, small pouches or sacks, silver cross, mirror, magnifying glass, binoculars, pocket digital disc recorder/player for recording his diagnoses and observations, 1D4 writing implements. A horse, or car or hover vehicle but only if the character can drive.

Medical kit with soap, disposable towels, bandages, suture tape, antiseptics, protein healing suave, aspirin, painkillers, antibiotics, sedatives, anesthetics, hypodermic gun, stethoscope, pen flashlight and portable compu-drug dispenser. As well as another bag of holistic herbs, teas, salves and potions.

Surgical kit includes a variety of scalpels, one laser scalpel, needles, clamps, sutures, suture tape, suture gun, several IRMSS/Internal Robot Micro-Surgeon Systems, RMK/Robot Medical Kit, hand-held blood pressure machine (computerized), 3D4 thermometers, six unbreakable specimen containers, 100 pairs of disposable surgical gloves, two pair of reusable surgical gloves, and other basic items.



Money: Starts with 1D6 × 1000 in credit and 3D4 × 1000 credits worth of gold, jewelry, and artifacts. The gypsy enjoys the good life and tends to spend his money quickly and freely on life's many pleasures and extravagances.

Cybernetics: Starts with none and will avoid getting cybernetics except for medical reasons. This character will never consider bio-wizardry items.

INFILTRATION

BY KEVIN SIEMBEDA



KEVIN SIEMBIEDA - 94



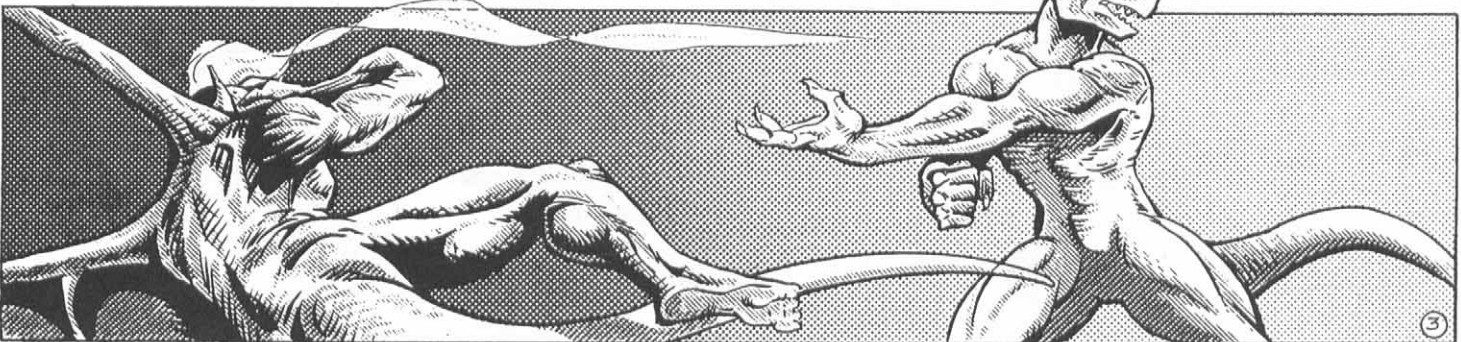



I WONDER HOW LONG HE WALKED AMONG US? THIS ROBOT WAS THE MOST CONVINCING YET. SO REAL. SO LIFE-LIKE. THE HUMAN'S TECHNOLOGY IS EQUAL TO ANY MAGIC I HAVE EVER KNOWN.

SIRE, I BELIEVE THIS ONE IS A CYBORG.





YES, SIRE. UNDOUBTEDLY
ONE OF MANY. THESE 'BORGS'
ARE DIFFICULT TO DETECT. THEY
SHOW EMOTION, CUNNING AND
HUMAN RESOURCEFULNESS — PLUS
BEING PART MAN AND MACHINE
OUR ROBOT AND RADIO DETECTION
DEVICES ARE USELESS.



Gargoyle Empire

The observations of Erin Tarn

Erin Tarn made this account:

“Shortly after our arrival to the New German Republic, Victor Lazlo was called to visit a friend in the country once known as Poland. We had been travelling for some time when, in the distance, we spied the ruins of an ancient Pre-Rifts city. Of course I wanted to explore it. A couple of my companions chuckled and shook their heads, ‘No.’ One explained that it was almost certainly a haven for gargoyles. Victor described how gargoyles liked to inhabit the ruins of ancient cities. ‘Like maggots among the bones of the dead.’ added one of our companions. They should have known me better by then. I had to see it firsthand! Victor growled his disapproval, but I wouldn’t take no for an answer.

“We left our vehicles miles from the city to avoid detection and proceeded on foot. One of the powerful mages who accompanied us had used his magic to turn us invisible. Gargoyles can’t see the invisible but have keen senses of smell, hearing, and hawk-like vision, so we still needed to use extreme caution.

“I had heard gargoyles and gurgoyles liked to inhabit forests and live in the trees. Indeed they do. Several miles from the city, as we travelled through the underbrush of a light forest, we heard the rustle of leaves overhead, looked up, and saw four or five gurgoyles half concealed among the branches. For every 50 gurgoyles, we’d spy one winged gargoyle, usually perched in the highest branches of a tree. I wondered how many unsuspecting travelers fell prey to gargoyle ambushes because they failed to look up.

“As we approached the city, I began to question the wisdom of this trek. The closer we got, the more monsters we had to avoid. On the outskirts of the city, virtually every tree was filled with scores of the creatures. There must have been thousands! They reminded me of a flock of giant demonic birds. Most were dozing in the warm autumn sun. Others chattered and snarled in their native gargoyle tongue, Gobblely or Dragonese. I had pictured gargoyle society as an armed camp of grunting neanderthals, beating their chests, and fighting amongst themselves. Instead, I found them to be playful and tolerant with each other. Although they squabbled, shoved, and wrestled, there was no bloodshed and none of the fighting seemed meant to inflict great injury.

“I had never seen these creatures in their natural environment, so I was surprised to see such savage monsters so relaxed, indulgent and friendly. I was equally amazed by their grace, agility and speed. From time to time, a small group of gargoyles would leap from branch to branch like monkeys. The tail also served as a rudder, allowing the gargoyles to change direction in mid-air and provide them with greater balance. I could now imagine that the gargoyle’s home world must be a land of endless forests with saplings the size of Millennium Trees. Of course, I have no idea. While I pondered such things, we arrived at the edge of the city.

“The forest ran up and into the city so we had leafy cover all the way in. The city lay in absolute ruin. For the most part, the place was overgrown with vegetation. Vines climbed the walls of buildings. Tall grass, weeds, and underbrush were everywhere. There were even areas completely overgrown with trees, like an unkept city park. The plants made their home in 300 years of dust and dirt that buried the old city streets and many of the smaller houses.

“The buildings that still stood, served as the dilapidated roosts for gargoyles and gurgoyles alike. There was no reason to repair or restore the buildings. The gargoyles don’t care about appearance and they are not adversely affected by weather. Furthermore, they love the outdoors and dislike confining spaces. Consequently, one could see gargoyles and gurgoyles perched on ledges, windows, fallen beams, walls and rooftops. Smashed out windows and gaping holes functioned as doorways. Many had been widened to accommodate the giant creatures. In some cases, an entire wall was missing, showing the rusted skeleton of metal girders.

“The closer I looked, I began to realize that the gargoyles had made a number of additions and changes. Iron girders, beams, tree trunks and even old, mangled buses had been stuck into the sides of buildings to create more perches to rest on. From many of the beams and openings hung ropes or cables used by the gargoyles to climb and swing. In a few instances, a canopy of cables hung like a tattered net or demented jungle gym where the gargoyles romped and played. Ancient automobiles and the debris from toppled buildings were gathered and used like crude building blocks to make towers and mounds. These towers were often built on the roofs of buildings to make them higher. From the debris towers, there were more beams, girders and protrusions for perches. The highest points were often graced with totem poles or crude statues hewn from rock or trees.

“The tallest buildings were obviously the favorites of the winged gargoyles. It seemed that the majority of gurgoyles lived on the lower levels, from the ground to about ten stories up. They hung from glassless windows and holes, perched on walls, cavorted up the sides of buildings, dangled from cables, and leapt from perch to perch. Although I could spot gurgoyles on the higher levels, it was clear that the domain of the giant gargoyles began at the tenth story and continued upward.

“On the ground was the occasional gargoyle and the infrequent gargoyle or gargoylite. By comparison, the ground level seemed deserted. Again, I learned that things were not as they seemed at first glance. Standing at one place for a long period of time, I saw a cavalcade of misanthropes scurrying from one place to another. I recognized goblins, boogie-men, simvan, a variety of D-bees and the occasional brodkil, ogre, and giant. Although we did not see any dragons, Sir Thorpe thought he recognized the tracks of a nightstalker.

“Victor explained that lesser monsters associated with gargoyles. Many, such as goblins and boogie-men, made their homes below the surface. This made perfect sense. Below the buildings and rubble were basements, parking structures, old



sewage tunnels and even the occasional subway (depending on the city). These were wonderful dwellings for subterranean beings who could clear out these places and add their own network of tunnels and mazes. Shy creatures like the boogie-men, and solitary demons like ghouls, could establish lairs without fear of intrusion by humans, for who would dare to invade a city occupied by thousands of gargoyles. Others, like the ogres and giants, joined the gargoyles as warriors committed to destroying or enslaving humankind. Some of the D-bees also joined the gargoyles for an opportunity to get revenge, plunder and kill. However, most D-bees and any humans are likely to be slaves or cattle.

“According to my companions, there are several cities like this one scattered throughout Europe, especially in France (including legendary Paris), Belgium, Austria and Italy; all of which fall into the territory claimed by the Gargoyle Empire. I find myself thinking the word ‘city’ seems inappropriate. It is certainly not a city in the human sense. There are no institutions of learning, science, medicine, manufacturing, farming, or socialization. There are few laws and little sense of history. This community of gargoyles is only a city because they inhabit one area and the size of the population must number into the tens of thousands (I could not hazard a guess at their total number).

“On our way back through the forest I was anxious for the safety of our vehicles. Unfortunately, our passage became blocked by a particularly rowdy group of gargoyles who tumbled to the ground in a great commotion. An instant later, it began to rain gargoyles as scores of them began to drop from the trees to cheer on the wrestling match. At least a dozen joined the struggle so that there were nearly 20 bodies flailing on the ground. The gathering crowd screeched and howled their approval and encouragement. Those in the trees rattled branches and howled along with them. We, on other hand, were trapped. Although still invisible, we clung to the shadows, hoping we would not be noticed. A few moments later, I realized that a pair of particularly mean looking gargoyles were looking in our direction and sniffing the air. I didn’t need to be an expert about gargoyles to know that these two had caught a whiff of our scent. I mentally chastised myself for letting my curiosity put us in such danger.

“Suddenly, there was a crash of mystic lightning followed by a thunderous bellow. Three gargoyles came crashing through the trees from above. One turned to solid stone before my eyes. From what I could understand, the three winged giants were not in the mood for roughhousing and did not appreciate their afternoon nap being interrupted. They pulled the wrestlers apart with claws and tails, throwing them against trees and other gargoyles. The crowd scurried into the woods or back into the trees to avoid the ire of their superiors. Thankfully, the two ugly brutes who had caught wind of our presence went with them. We took this opportunity to make our escape and reached our vehicles without further incident.

“I have since witnessed gargoyles in combat against humans and D-bees. In the field of battle they seem neither playful nor tolerant. They fight like demons without mercy and with great viciousness and cruelty. I cannot imagine having to face down a great swarm of these creatures and can better understand (but not condone) the fear and paranoia that grips the people of the New German Republic. We are lucky that although there are large gatherings like the one we had visited and they sometimes sweep the land in great flocks and marauding hordes, gargoyles

are more likely to operate in much smaller and manageable splinter groups. However, I am told that the minions of the Gargoyle Empire have exhibited a growing understanding of technology, use it with increasing proficiency and seem to be more organized than any gargoyle force man has ever encountered previously. I pray these reports are erroneous.

**Excerpted from a letter by Erin Tarn —
Autumn, Circa 103 PA**

About Gargoyles

The gargoyle is a sub-species of the so-called demons — supernatural beings from other dimensions. Most demons are predatory beasts that either prey on humans and D-bees, or like to torment and hurt them. Most supernatural beings possess super-human strength and powers, including psionics and magic. On a supernatural scale of one to ten, with ten being the most powerful, gargoyles generally rate only as a two or three. The gargoyle’s humanoid shape, vulnerabilities and comparatively minor powers have relegated them to the category of sub-demons. Most humans assume they are reptilian in nature, because they are born from an egg. This is not true. The gargoyle is more closely related to a warm-blooded, predatory bird than a lizard.

Regardless of what exactly gargoyles may be and how they rate against other supernatural creatures, compared to humans, they are powerful giants who possess supernatural strength, limited psionic powers and some degree of magic. Like so many other supernatural beings and creatures of magic, gargoyles traditionally rely on their supernatural powers and size. In this case, they also rely on their vast numbers to overwhelm enemies. As a rule, they never develop an understanding of science or learn to use technology. In part, this is because gargoyle society is fragmented and chaotic. Like birds, they congregate in great flocks that can number into the millions. Also like birds, gargoyles are attracted to flocks, instinctively joining them and following wherever they go. If the flock travels to a particular place, the majority follows. If the flock engages in war, the majority of its members join the battle. This often creates the illusion of leadership and organization, but in reality, there is little structure to gargoyle society other than the fact that they flock together and get swept up in the frenzy of the crowd.

Individual gargoyles and small groups (a half dozen to a thousand depending on the size of the flock) are constantly splintering from the larger group to make stops or to investigate places, people, and things. They may rejoin the flock later, join a different flock, or continue on their own. Regardless of the flock’s size, it is little more than a giant gathering of selfish individuals who do not work particularly well together.

To stay with the bird analogy, picture this scene that we’ve all seen in our own backyards. When a single bird finds a slice of bread, it immediately begins to eat it. Inevitably, several other birds see the bounty and fly in to join the feast. They don’t share, they just take. The original finder of the bread may see it torn in half and two other birds (from the same flock or a different one) fly off with the bread. Both are pursued by several other hungry birds attracted by the ruckus and the sight of food. They may squawk and peck at each other for ownership of the morsel, but they seldom seriously hurt one another. While two or three squabble and posture with each other, another snatches

the bread and takes off with it. The entire situation is a frantic free-for-all. When the bread is finally devoured, they fly off to find more or sit around grooming each other. The tumult of the moment is forgotten until the next morsel of food is discovered. During all of this time, birds who weren't hungry stayed out of the squabble, basking in the warm sun or watching with dispassionate eyes. Although most humans don't realize it, they have just witnessed an example of gargoyle society in action.

Like birds, gargoyles are animalistic creatures who are driven by instinct more than intellect. They hunt, feed, mate, fight and move on. They don't have families and rarely develop friendships. A mated pair join only for the purpose of procreation. They stay together only long enough to spawn, lay eggs, place them in a hatchery, help protect them until they hatch, get the offspring started and then depart. Males and females rarely stay together for more than a year and will have scores of mates throughout their lifetimes. Like most hatchlings, they don't recognize families and have no idea who their parents, brothers, sisters or children may be. Nor do they care.

Their instincts tell them that there is safety and strength in numbers, so they gather in flocks. As a flock animal, complete strangers of the same species are usually welcomed, like a member of transdimensional fraternity. When the flock is threatened its members respond in various ways. Some will break and flee, others will fight to the death, but most will follow the flock whether it be one or the other. One must remember that the gargoyle flock is a gathering of predators. As such, they are aggressive, mean and savage, especially toward non-gargoyles and creatures seen as prey.

Gargoyles are omnivorous, meaning they can eat a variety of different foods, including fruit, nuts, grains, vegetables and meat. The gargoyle's favorite food is raw meat, particularly the flesh of large mammals, including humans and other humanoids. Some people incorrectly call gargoyles cannibals. A cannibal eats his own kind — gargoyles do not eat their fellow gargoyles. Slain comrades are either left where they fall or gathered and burnt in a funeral pyre of magic fire.

The Gargoyle Hierarchy

The general term "gargoyle" refers to the entire gargoyle race, like the term "birds" refers to all birds, whether they be sparrows or eagles. Among gargoyles there are three very distinct types: the giant winged gargoyles, the smaller flightless gurgoyles and the diminutive gargoylites.

Gurgoyles and gargoylites are usually submissive to all gargoyles. This is in harmony with these creatures' instincts and regard for power. Gargoyles are large, strong, smart and can fly, giving them an indisputable advantage over their smaller brothers and a higher place in the social order.

Among the winged gargoyles, there are less obvious distinctions of different types. Although the strongest gargoyle warriors will have a higher place in the "pecking" order than others, there are natural leaders with even greater power. The **Gargoyle Mage** possesses a natural link to elemental forces of magic similar to a human warlock (see **Rifts Conversion Book One** for descriptions about the Warlock O.C.C. and elemental magic). Although a mage can become a king or queen, they are usually relegated to the status of secondary generals and advisors to the king, queen and other leaders. The true leaders within gargoyle society

are the **Gargoyle Lords**. They are usually larger, stronger and smarter than most other gargoyles. In addition, they possess the power to metamorph into living stone, making them more powerful still.

The final "pecking order" is determined through combat and intimidation. The gargoyle hierarchy goes something like this:

Gargoyle King and/or Queen (of a flock)

Gargoyle Lords

Gargoyle Mages

Gargoyles — Winged giants with superior strength.

Gurgoyles — Smaller, weaker, wingless gargoyles

Gargoylites — Tiny, physically weak beings, few in number.

Other beings — Accepted as part of the community.

It is interesting to note that gargoyles will accept other supernatural beings as a member of their flock and even as a king or queen. Gargoyles respect and fear power, and are almost always submissive to it. This has made them the ideal troops, minions and fodder for powerful supernatural beings. Dragons, demon lords and alien intelligences are their most likely masters, but gods and other beings have also been known to command legions of gargoyles. Among gargoyles, it is always the most powerful who rules. Typical leaders are creatures (not necessarily a gargoyle) who are more powerful than the norm. The most powerful becomes the king or queen.

Ultimately the power structure of a gargoyle community is in a descending order of raw power and ambition. From time to time, that order may be challenged from new members, like young reaching full maturity or outsiders who recently joined the flock. These individual battles and duels are rarely to the death. In fact, gargoyles seldom kill each other or wage war on other gargoyle communities. There are seldom warring rival flocks, although there may be different communities under different leadership. For example: The gargoyles of Atlantis follow and obey Lord Splynncryth, while the members of the Gargoyle Empire are a different flock who obey Zerstrun and his generals. Other flocks in other parts of the world and in other dimensions follow other leaders.

Gargoyles may accept and even worship other *supernatural* beings and creatures of magic, but they *never* accept mortal humans or D-bees. A powerful, evil, human practitioner of magic may summon and command a dozen or more gargoyles, but they rarely accept him as their equal and slay him if they have the opportunity. Likewise, only monstrous D-bees may be accepted into the fold, but they can never rise above the status of an ordinary gargoyle. Here again, instincts come into play. All mortal humans and most humanoids are seen as prey regardless of their sophistication and power. Unless a human or D-bee somehow comes to possess great supernatural powers, he or she will always be regarded as "meat."

Habitats

All gargoyles are creatures of the wilderness. They do not erect cities with streets, lights, trains, shops and buildings. Instead they meld with nature, living in trees and on mountains. Many are nomadic, constantly travelling and exploring new realms.

The winged gargoyles love the high ground and, if given the choice, will congregate in the mountains. In Europe the Gargoyle Empire has laid claim to the French, Italian, Swiss and Bavarian

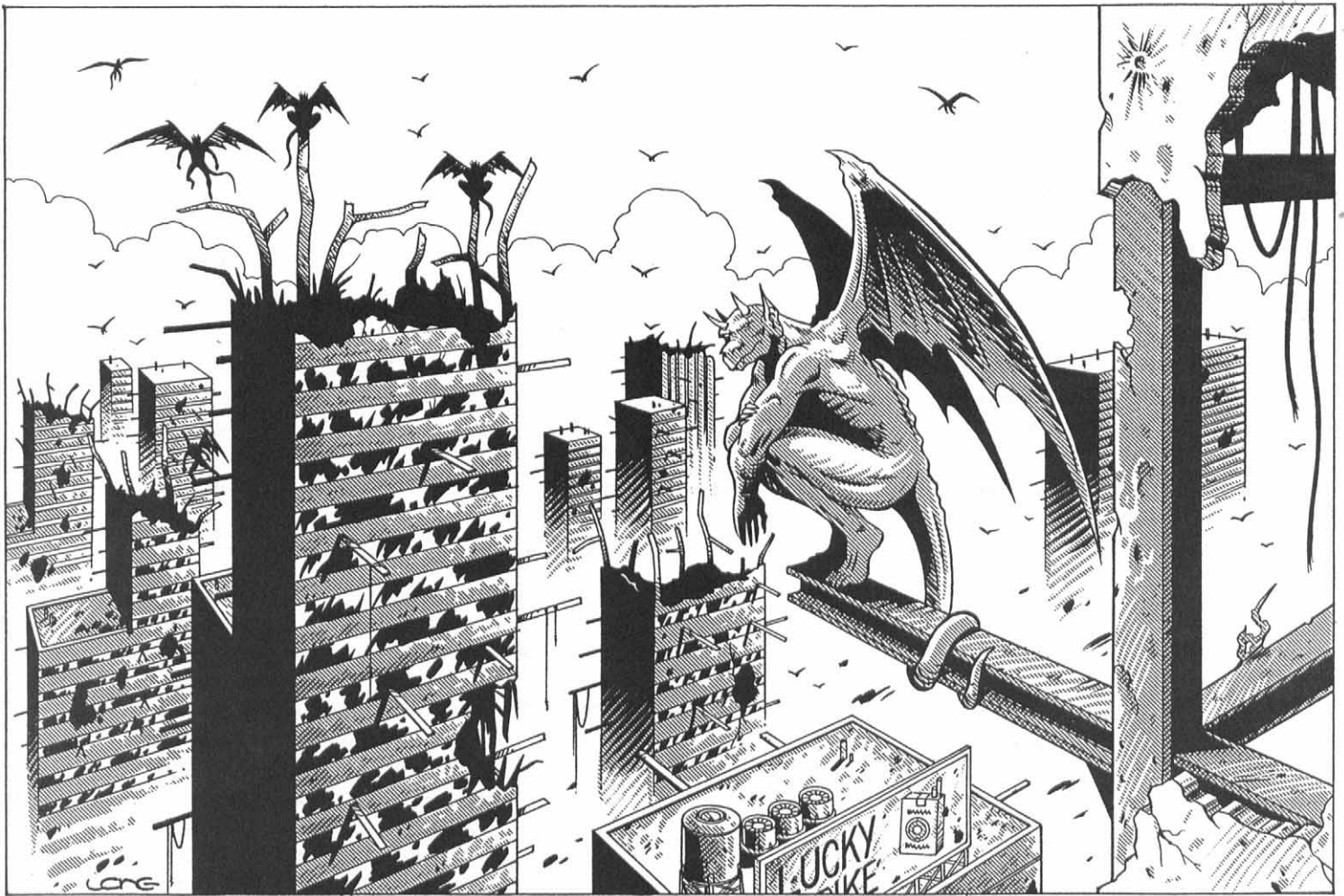

Alps. Mountain communities are frequently carved out of the mountains. They usually start with a natural cave, cavern, or canyon and enlarge or modify it to fit their needs. Gargoyles, slaves and magic are used to dig these mountain tunnels and chambers. These lairs are often huge, with chambers the size of football stadiums and wide tunnels connecting the various chambers and leading back outside. Gargoyles and their kin will also live outdoors, among the rocks, peaks and trees (if not too high up the mountain).

Gurgoyles like to live in mountainous regions. However, unlike their winged brothers, they cannot fly up to the highest peaks and back down to the forested lowlands to search for prey like hungry eagles. Instead, gurgoyles stay in or near the mountain forests and lowlands closer to prey. They also inhabit the ruins of pre-rifts cities and conquered enemies. Both the gurgoyles and gargoyles enjoy the artificial canyons, caves, peaks and spires of human cities (see the Erin Tarn description at the beginning of the Gargoyle Empire section).

Note: The forest line stops at about 5000 feet (1524 m) up the mountain. Alpine pasture and tundra (scrub; no trees) continues to about 8500 feet (2590 m) before turning into glacial rock, snow and ice. The winged gargoyles love the high peaks and often roost among them, while the majority of the gurgoyles inhabit the lower forests and scrub areas.

Forest City Areas

When gargoyles settle at one location they establish a dwelling place rather than a city. Of course there are exceptions. For

example, the gargoyles of Atlantis, under the guidance and rule of the Splugorth, are more organized and have a few streets, shops and coliseum style arenas. By comparison, the gargoyles of Europe are far more primitive. Still, there are things consistent to most gargoyle communities that are exemplified by the monsters of the Gargoyle Empire.

A typical community/city will be located at a fixed gathering place. Here the majority of the flock (75%) congregates. Gargoyle communities, whether they are located in the forest or the mountains, are filled with totem poles, megaliths and towers made of stones and debris. Gargoyles mark the borders of their domains with totem poles, giving fair warning to travelers and foolish intruders.

The term city "area" is used, because unless the creatures inhabit a conquered city or ruins erected by some other life form, they do not build roads, houses or buildings. Instead, they live in the trees and/or build a central area filled with totem poles, pillars, megaliths and debris towers. Giant boulders and trees are used to make totem poles and megaliths, but everything is used to make debris towers, including rocks, trees, mangled and captured vehicles, hunks of robots, chunks of buildings, bones and anything else that can be used as building material. These towers typically stand 100 to 500 feet tall (30.5 m to 152 m) and have many horizontal beams that serve as perches for the creatures. Totem poles and pillars seldom exceed 100 feet (30.5 m).

A city "area" will also have several gladiatorial arenas, hunting lodges, metalsmiths and a hatchery. Any merchant shops, board-

ing houses, and other buildings (or tents) will be the handiwork of non-gargoyle allies allowed to live with the gargoyles (or prisoners enslaved by them). Any road or pathway is simply the result of the plants and ground being trampled flat.

A **gargoyle arena** is typically a large, 20 to 50 foot (6 to 15 m) deep pit dug into the ground. The size can vary from something as small as the equivalent of a basement for a house to the length and circumference of a football stadium. Pillars, trees, and totem poles encircle the pit, providing perches for the spectators. The arena is the site of festivals, games, gambling, physical contests, wrestling, duels, torture, gladiatorial combat, and all manner of blood sports.

A **gargoyle hunting lodge** is typically a cave, series of large huts, cavern, valley, pit or area where the warriors gather to boast of their triumphs, exchange tales of combat, show off their spoils and trade items.

Metalsmiths: Gargoyles are reasonably competent metalworkers and traditionally make many of their own metal swords and other weapons. Huge stone furnaces surrounded by an arcade wall denotes the location of a smith.

The hatchery is almost always hidden in caves or subterranean chambers. It can be a natural formation or dug out by the gargoyles. Unlike the rest of the city "area" with its pillars and towers, the location of the hatchery has no such markings and is usually concealed by rubble and large rocks. Inside, the brood of eggs are guarded by a minimum of 2D4 gargoyle mages, 4D6 gargoyle lords, 1D4 × 10 gargoyles, and 1D6 × 10 gurgoyles (males and females). If a nest is invaded, the entire flock will fight to the death to defend the eggs.

Gargoyles proliferate in great numbers, hatching from broods of eggs that often number into the thousands, even millions! Female gargoyles lay 3D6 eggs once every 10 months. One in a hundred is a gargoyle lord and one in every 20,000 is a gargoyle mage. Gurgoyles lay 4D6 eggs, while gargoyle lites, the rarest of the breed, lay only 1D4 eggs every 10 months.

The eggs are collected and protected in large, heavily guarded hatcheries. The eggs hatch within three months. The parents will help care for all the young for about the first four to six months. After that time, the young are strong enough to fend for themselves. The young reach full maturity within two years (play young as having half the usual mega-damage and attribute stats). The male/female ratio is roughly 55% male and 45% female.

The Empire

Despite all the references to gargoyles being like birds, they are not creatures of pure instinct and do have human-like intelligence. Gargoyles can learn to use weapons, tools, math and science (at least to some degree). They have their own spoken language and usually learn to speak two or three others. They also exhibit some degree of ingenuity and inventiveness.

Although the gargoyles, gurgoyles, brodkil and other supernatural beings still tend to rely on magic, psionics and their natural powers, the troops in the Gargoyle Empire have a fair understanding of technology. This means they are much quicker

at recognizing the value, powers, effects and dangers of robots, weapons, vehicles, and devices, enabling them to respond appropriately.

In the last few years, The gargoyles and their minions have actively hired high-tech mercenaries, designers, builders and mechanics. The Gargoyle Empire and brodkil have added fundamental assault weapons and equipment to their arsenal. This includes energy weapons, rail guns, Kittani plasma weapons and explosives. Equipment includes such notable items as radios and camera/optical equipment, detection devices, and even giant robots and cybernetics! In most instances, the gargoyles and their minions could never design, build or repair a device as simple as a flashlight, but they know how to use and maintain it.

A mysterious kingdom/manufacturer known as **Mindwerks** has been instrumental in providing the gargoyles and their minions with much of their high-tech equipment. So have the Splugorth (secretly), the New Phoenix Empire and others.

A Dangerous Force

The members of the Gargoyle Empire have become a dangerous anomaly. For the first time in eons, they have established a more organized society and have adopted some of the ways of humans, using weapons and machines modeled after man's. Although this is unusual, it fits with the gargoyle's instinctive pattern for "survival of the fittest." Their adaptation to using high-tech items makes them stronger, and strength is good!

They are also a rarity because they do not answer to a higher life form such as a demon lord, god or alien intelligence. Without a supreme power to lead them, control their birth rate or send millions on missions of doom, their numbers are growing at an alarming rate. This makes them incredibly dangerous. Unchecked, the evil Empire could conquer Europe and turn their attention to other lands. This is something that not only concerns the humans, but Lord Splynnrcryth and other forces.

The prime mover behind the Gargoyle Empire and its use of technology, is Emperor Zerstrun (pronounced Zeer strun). This gargoyle lord is a charismatic leader who has proven himself in combat and has won the hearts and minds of his people. He has shown them that gargoyles can be the masters of their own destiny. That they don't need a demon lord or other powerful being to lead them. He has given success through unity, organization, cunning and adaptation. The Emperor inspires them with talk of vengeance, conquest and destiny. He works his troops into a savage frenzy and sends them forth to do his bidding. At least for the moment, his flock is dedicated and loyal to him and his cause.

Emperor Zerstrun has been savvy enough to make alliances with the New Phoenix Empire, Mindwerks, brodkil, gene-splicers and other forces, to acquire modern weapons, equipment and knowledge. These same allies supply the Empire with the equipment they need in exchange for captured booty, gold, raw materials and services (protection, assassination, etc.). He has also been forceful enough to make his minions learn these new ways and use technology. As long as the Empire continues to have one success after another, the lesser gargoyles and minions will remain loyal, become bolder, and grow in their expertise with the creations of man. **Note:** If Emperor Zerstrun is slain, most of the gargoyles will forsake the learning of science and technology, especially the use of vehicles, bots and electronic

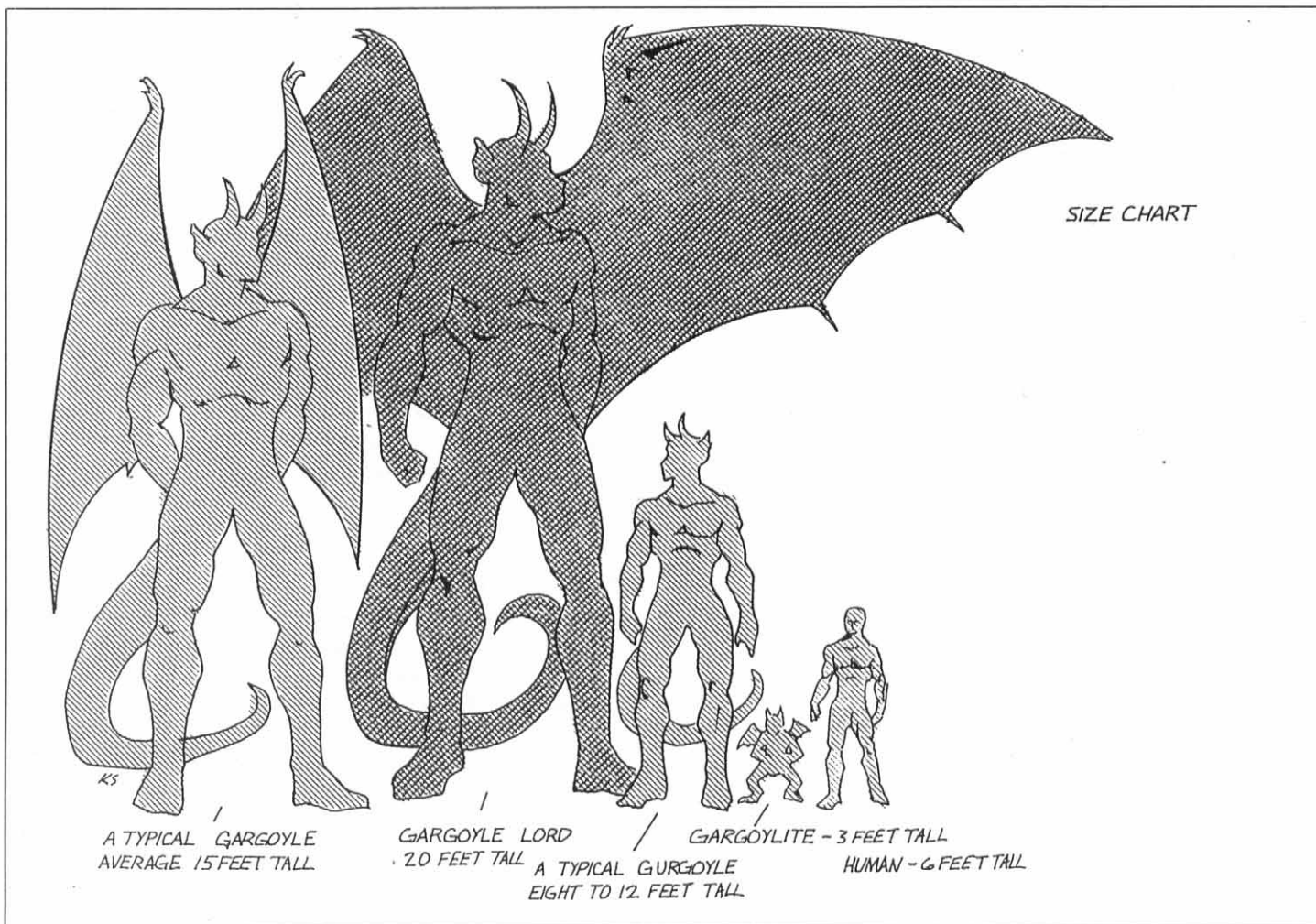

equipment, and return to their old ways. However, they will keep using modern weapons. Likewise, if Zerstrun is somehow badly discredited, some of his troops will leave the Empire to join other flocks.

Ironically, the gargoyles' growing reliance on man's technology and machines has ostracized them from their demonic kin — never have demons, even gargoyle sub-demons, become so independent or come to rely so completely on technology like the Gargoyle Empire in Europe. This is a development that worries some demon lords and gods. They fear that these gargoyles may get too powerful, too bold, and may one day challenge them. For the moment, they do nothing, but at some point they may decide to wage war against them, sending their own demonic hordes upon the Earth.

Even Lord Splynncryth of Atlantis has become concerned. At first he found the Gargoyle Empire to be very amusing — excellent entertainment and a good market for the sale of weapons and miscellaneous supplies. However, with the sudden introduction of power armor, robots, and major (unknown) players like Mindwerks and gene-splicers, the conflict has taken a new and disturbing twist. If the Empire grows too powerful, it will definitely change the dynamics of politics on Earth — particularly among supernatural forces. The Earth, with its thousands of dimensional rifts, is too valuable a commodity for any one power to control, especially gargoyle sub-demons. For now, Lord Splynncryth simply observes. He has slowed sales to the Empire but wants to keep his ties with them to better spy on these ambitious upstarts.

Gargoyles & Gurgoyles

Optional Player Characters

Gargoyles are huge demonic looking creatures who appear to be giant lizard-like humanoids with massive bat wings, sharp-toothed maw, dark green or grey-green skin, and blazing yellow eyes. The gargoyle's reptilian appearance is a bit deceptive, for though they are hatched from eggs, they are warm-blooded. The specter of their grim visage can be seen in legends throughout Earth's history, which means they have visited our planet in the past.

Although considered to be demons, they are creatures from another dimension. Gargoyles have a pack mentality and travel in vast flocks. In days past, one rarely encountered more than a pair on Earth, but since the coming of the rifts, they are all too common, especially in Europe and China. Vast legions of gargoyles have joined forces with other supernatural and/or alien beings to create scattered kingdoms throughout parts of Spain, France, Italy, Austria, Germany, Poland, Czechoslovakia, Hungary, Romania, Russia, and perhaps elsewhere as well. They are constantly warring against the New German Republic.

Gargoyles have a low intelligence and tend to rely on brute strength, natural powers and superior numbers. However, they are not stupid and can be very treacherous and are always ruthless. Remember, gargoyles (and gurgoyles) are instinctively aggressive predators who work as individuals and in small groups, as well as part of a large flock or tribe. They love to fight and

will die with a toothy grin etched across their lips. Part of the pack mentality is to secure a territory, mate and expand. Thus, the presence of gargoyles and their kin could spell disaster for Earth if their population is not held in check. Gargoyles are definitely demonic *invaders* who will try to conquer the planet.



Gurgoyles are somewhat smaller, wingless versions of gargoyles. They are equally vicious and serve as the foot soldiers of the invading hordes. They are excellent warriors and ruthless in combat. Gurgoyles and gargoyles are familiar with the use of energy weapons and some of the non-human kingdoms actually manufacture energy weapons for them. It is the gurgoyles who wear plate body armor and operate the newly developed power armor and giant robots. Gargoyles prefer heavy weapons like rail guns, pulse rifles, particle beam and plasma weapons. Both gargoyles and gurgoyles have a special fondness for vibroblades, rune weapons and whips/chain weapons.

Gargoyles are always submissive and loyal to gargoyle mages, lords and their winged brothers (gargoyles). Both gurgoyles and gargoyles are carnivores who feast on the flesh of any living creature who falls prey to them, from cattle to humans. Although gurgoyles and gargoyles possess some psychic abilities, it is only the gargoyle lords and mages who possess great magic or psionic power.

Gargoyle and Gurgoyles R.C.C.

Alignment: Typically anarchist or evil, but can be any.

Attributes (Gargoyle): The number of six-sided dice to roll is as indicated: I.Q. 2D6+2, M.E. 3D6+1, M.A. 2D6+2, P.S. 18+2D6, P.P. 18+2D6, P.E. 18+2D6, P.B. 2D6, Spd running

5D6, but speed flying is 2D4×10+10.

Attributes (Gurgoyles): The number of six-sided dice to roll is as indicated: I.Q. 2D6, M.E. 3D6, M.A. 2D6, P.S. 24+2D6, P.P. 18+2D6, P.E. 18+2D6, P.B. 2D6, Spd running 10+6D6.

Hit Points: See M.D.C.; become mega-damage beings on Rifts Earth.

Natural Armor Rating: See M.D.C.

M.D.C.: Gargoyle: 1D6×100+100, Gurgoyles: 1D4×100

Horror Factor: 16 gargoyle, 14 gurgoyles

P.P.E.: 2D6 for typical gurgoyles and gargoyles.

Natural Abilities: Gargoyles can fly, both gargoyles and gurgoyles have superior night vision (can see in one-tenth the light needed by a human) and superior, hawk-like day vision and are able to see a foot tall (0.3 m) target 2 miles (3.2 m) away. The tails are not prehensile, but are agile and strong enough to be used like an arm to hit a target. Gargoyles can leap 100 feet (30.5 m), gliding with their wings. Gurgoyles leap 40 feet (12 m). Both can bio-regenerate 4D6 M.D. every hour.

Combat: Both creatures have five attacks per melee.

Damage: Restrained claw attack inflicts 4D6 S.D.C. damage plus P.S. bonus, full strength claw/punch or kick inflicts 3D6 M.D. (gargoyles and gurgoyles with a P.S. of 31 or higher do 4D6 M.D.), power punch does 6D6 M.D., but counts as two attacks, strike with the tail does 2D6 M.D., bite does 2D6 M.D., or by weapon. Gargoyles can also perform a flying tackle that does 2D6 M.D. and has a 75% chance of knocking the person down (victim loses one attack and initiative), but counts as two attacks.

Bonuses: In addition to physical attributes, +2 on initiative, +1 to strike, +2 to parry and dodge, +4 to dodge while in flight, +1 to save vs psionic attacks, and +10 to save vs horror factor.

Psionics: I.S.P. is 1D4×10. Meditation, mind block, presence sense, sense magic, telepathy, resist hunger, resist fatigue and resist thirst. Equal to a 6th level psychic.

Magic: Only gargoyle mages can learn magic.

R.C.C.s: The average gargoyle and gurgoyles is a warrior, but also see *Gargoyle Lord*, *Gargoyle Mage* and *Gargoyles* which follow.

R.C.C. Warrior Skills: Detect ambush (+10%), detect concealment (+10%), escape artist (gurgoyles only, +10%), intelligence (+8%), track humanoids (+10%), wilderness survival (+15%), first aid (+5%), prowl (+10), climb (+10%), swim (gurgoyles only +10%, gargoyles are -10%), W.P. sword, W.P. energy weapon of choice and two additional of choice (any), speak Gargoyle, Dragonese/Elven and Gobblely 98% and can learn two other languages (+10%), plus the character can select six additional secondary skills from any category except electrical, mechanical, medical and science (no skill bonuses).

Level of Experience: Player characters use the same experience table as the psi-stalker. The average NPC warrior will be 1D4 level.

Habitat: Common to Europe and China, particularly Spain, France, Italy, Austria, Germany, Poland, Romania and Russia, perhaps elsewhere as well. Gargoyles love mountainous, forests and hilly terrain.

Average Life Span: 300 to 500 years, but some have been known to live as long as a thousand years.

Value: As a slave in the gladiatorial arena, one can command a price of 75,000 to 150,000 credits.

Enemies: Generally speaking, gargoyles and their kin do not get along well with most true supernatural beings. They hate vampires and detest ghouls and devilkins. They tend to stay with their own kind. Those they do accept tend to be powerful creatures to whom they are usually subservient.

The members of the Gargoyle Empire have broken this general rule and freely associate with most monster races other than vampires. This makes other gargoyles look upon them as a disturbing anomaly.

Allies: Gargoyles frequently join forces with other supernatural beings and monstrous D-bees. They are especially friendly toward trolls and other giants, mutant animals, and so-called lesser demons because they are on more of an equal footing with them. Many gargoyles are also friendly with the Splugorth who frequently employ them as guardians, scouts and slavers. The Splugorth have given one particular tribe/flock of gargoyles dominion over the northwestern mountains of Atlantis.

The Gargoyle Empire of Europe is officially allied with the New Phoenix Empire, Mindwerks, and other regional monster forces, including the brodkil and gene-splicers. However, most other alliances are tentative and subject to change.

Size Gargoyle: 10 to 20 feet tall (3 to 6 m), wingspan is 20 ft (6 m) and weigh 1200 to 2000 pounds (540 to 900 kg).

Size Gurgoyles: Gurgoyles are 8 to 12 ft (2.4 to 3.6 m) tall and weigh 800 to 1000 pounds (360 to 450 kg).

Notes: Gargoyles and gurgoyles are always loyal to their tribe or flock, even if that community has been adopted and is composed primarily of non-gargoyles. They work very well as a member of a small team and especially so under the direction of a gargoyle lord or powerful supernatural being. Males and females look nearly identical, only females tend to be a bit less muscular, have small horns and are a bit more fleshy or soft looking. Remember, gargoyles are hatched from eggs. They are not mammals, so the females do not have breasts and none have nipples or a belly button.

Gargoyle Lord

Gargoyle lords are so named because they are the natural leaders of the gargoyle species and possess powers not shared by others of their kind. Two of these powers include invisibility and metamorphosis into living stone. A gargoyle lord is considered to be of royal heritage and an elite warrior. One out of every hundred gargoyles is a lord, one out of every four to eight thousand gargoyles is recognized as a *high lord*. These are effectively generals or royal Dukes or Barons and usually of a high experience level (1D6+4) and of great physical strength or ability as a warrior. All lords organize and lead the gargoyles and gurgoyles in war, migration and social structure. It's interesting that most gargoyles do not make a great distinction between male or female and either gender can rule a flock.

The ultimate leader of a flock will be the most powerful of the gargoyle lords or mages. They are elevated to the position and title of King, Queen, Emperor or Ultimate High Lord. However, powerful supernatural creatures such as dragons, gods, demons and alien intelligences can become the ultimate high lord.

Gargoyle Lord R.C.C. Data

Data Note: All other information is the same as the basic gargoyle.

Alignments: Any, but usually anarchist or evil.

Attributes (lord): The number of six-sided dice to roll is as indicated: I.Q. 2D6+5, M.E. 3D6+2, M.A. 2D6+3, P.S. 24+2D6, P.P. 18+2D6 P.E. 18+2D6, P.B. 2D6+1, Spd running 5D6, but speed flying is 2D4×10+10.

Hit Points: See M.D.C.; become mega-damage beings on Rifts Earth.

Natural Armor Rating: See M.D.C.

M.D.C.: Gargoyle Lord: 1D4×100+300, also see stone metamorphosis.

Horror Factor: 16

P.P.E.: 6D6

Natural Abilities: The lord possesses special powers far beyond the normal gargoyle. One is the startling metamorphosis into living stone! The transformation can be performed three times per day, increasing M.D.C. by 200 and adds 1D6 M.D. to punches and kicks, but reduces speed by one-third. The creature can still fly in stone form but at half speed. The maximum duration of this metamorphosis is six hours per each transformation. Of course, the character can cancel the magic at any time. The gargoyle lord can also turn invisible at will, teleport self twice per day (range 2400 feet/732 m, 93% accuracy), breathe fire once per melee (4D6 M.D., range 90 feet/27.4 m), as well as the usual gargoyle abilities.

Combat: Six attacks per melee.

Damage: Restrained claw attack inflicts 4D6 S.D.C. damage plus P.S. bonus, full strength claw/punch inflicts 4D6 M.D., power punch does 1D6×10 M.D., but counts as two attacks, strike with tail 3D6 M.D., bite does 2D6 M.D., fire breath 4D6 M.D., or by weapon. Flying tackle does 2D6 M.D. (add 2D6 M.D. if in stone form) and has a 75% chance of knocking the person down (victim loses one attack and initiative), but counts as two attacks.

Bonuses: In addition to physical attribute bonuses the character is +2 on initiative, +3 to strike, parry and dodge, +6 to dodge while in flight, +3 on all saving throws, and +10 to save vs horror factor.

Psionics: I.S.P. is 1D6×10. Meditation, mind block, presence sense, sense magic, telepathy, resist hunger, resist fatigue and resist thirst. Equal to a 6th level psychic.

Magic: Only gargoyle mages can learn magic.

R.C.C.s: Same as the gargoyle.

R.C.C. Warlord Skills: Detect ambush (+10%), detect concealment (+10%), intelligence (+12%), track humanoids (+15%), wilderness survival (+15%), land navigation (+10%), prowl (+5), climb (+10%), swim (-10%), W.P. sword, W.P. energy weapon of choice and three others of choice (any), speaks Gargoyle, Dragonese/Elven and Gobblely 98%, literate in Dragonese 88%, and speaks four other languages (+10%), plus can select eight additional secondary skills from any category except electrical, mechanical, medical and science (+5% skill bonus).

Level of Experience: Player characters use the same experience table as the dragon. NPC lords will range 1D4+3 levels. High lords are 1D4+5 levels or higher. They are likely to have a legion of gargoyles and gurgoyles at their beck and call. The Ultimate High Lord is usually 10th level or higher.



and commands an entire flock which could number into the hundreds of thousands (sometimes millions).

Size: 15 to 20 feet tall (4.6 to 6 m) and weighing over two tons.

Note: There is one gargoyle lord for approximately every 100 gargoyles. These characters can amass a treasure trove of weapons, armor, artifacts, gems, precious metals and the occasional magic item.

Gargoyle Mage

The gargoyle mage is endowed with natural magic abilities through a supernatural link with elemental forces. These powers are similar to the human *elemental warlock* except their magic is limited to *one* specific area of elemental magic: Earth. These powers and the lord's ability to turn into living stone would suggest that gargoyles are somehow related to elementals. It is possible that they are actually lesser elementals or cousins to elemental beings. Whatever their connection to earth magic may be, it is unknown to the gargoyles. They accept their powers without question and their history offers no clues.

The gargoyle mage is a rarity. Only about one out of every 20,000 gargoyles is one. They look exactly like a typical gargoyle and can be of either sex. The mage is often the smartest and most charismatic of the gargoyle clan and use this to their advantage. They can become the Ultimate High Lord of a flock, but more often decide to serve as an advisor to the King. This is not done out of submissiveness but out of cunning. Frequently, it is a mage advisor who is the real power (or an equal power) behind the throne, manipulating the more physically powerful lord of the flock or using his voice to enforce the mage's edicts.

The gargoyle mage is also one of the few gargoyle characters to show great independence and have been known to leave a gargoyle flock to establish their own kingdom among non-gargoyles. In most instances, such kingdoms are relatively small and the people are non-human. Often the gargoyle mage is worshiped or feared as a god or demon lord by the likes of goblins, kobolds, orcs, and other creatures of low intelligence and warlike ways. There have even been incidents where a village or tribe of humans or D-bees have accepted the gargoyle as their ruler or god. **Note:** The mage often has a handful of subservient

gargoyles (2D4) and gurgoyles (3D4) to serve as members of his trusted guard and seconds in command. Of course, the number of gargoyles/gurgoyles among the mage's legion can be of a lower or greater number than those listed here and may also include a few gargoylites or other demonic minions. These splinter groups are usually fairly small, although the kingdom they rule can be comparatively large.

Gargoyle Mage R.C.C. Data

Data Note: All other information is the same as the gargoyle.

Alignments: Any, but usually anarchist or evil.

Attributes (Mage): The number of six-sided dice to roll is as indicated: I.Q. 2D6+6, M.E. 3D6+3, M.A. 3D6, P.S. 18+2D6, P.P. 18+2D6, P.E. 18+2D6, P.B. 2D6, Spd running 5D6, but speed flying is 2D4×10+10.

Hit Points: See M.D.C.; become mega-damage beings on Rifts Earth.

Natural Armor Rating: See M.D.C.

M.D.C.: Gargoyle Mage: 1D6×100+150

Horror Factor: 16

P.P.E.: 3D6×10

Natural Abilities: The mage possesses special powers greater than the typical gargoyle and different than the gargoyle lord: Turn invisible at will (unlimited duration) and earth elemental magic (described below), as well as teleport self twice per 24 hours (range 2400 feet/732 m, 93% accuracy), breathe fire once per melee (4-24 damage), as well as all the usual gargoyle abilities.

Combat: Five physical attacks per melee or four magic attacks.

Damage: Restrained claw attack inflicts 4D6 S.D.C. damage plus P.S. bonus, full strength claw/punch or kick inflicts 3D6 M.D., power punch does 6D6 M.D., but counts as two attacks, bite does 2D6 M.D., or by weapon. Flying tackle does 2D6 M.D. and has a 75% chance of knocking the person down (victim loses one attack and initiative), but counts as two attacks.

Bonuses: In addition to physical attribute bonuses the character is +3 on initiative, +2 to strike, parry and dodge, +4 to dodge while in flight, +4 to save vs magic, +3 on all other saving throws, and +12 to save vs horror factor.

Psionics: I.S.P. is 1D6×10. Meditation, mind block, presence sense, sense magic, sense evil, detect psionics, healing touch, exorcism, telepathy, resist hunger, resist fatigue and resist thirst. Equal to a 6th level psychic.

Magic: P.P.E. 3D6×10 plus an additional 2D6 points per level of experience. Possesses all 1-3 level earth elemental magic spells at a proficiency equal to a fourth level warlock, can speak to all elemental beings (80% language proficiency), has an 80% chance of seeing even an invisible elemental and can sense the presence of elementals within 1000 feet (305 m) of him. See **Rifts Conversion Book One** for descriptions about the Warlock O.C.C., elementals and elemental magic. Gargoyle mages can also study other areas of magic including herbology/herbalist, but few pursue such studies. However, most have a rudimentary understanding of the basic principles of magic, P.P.E. and ley lines.

R.C.C.s: Warlock and scholar.

R.C.C. Skills: Intelligence (+12%), track humanoids (+5%), wilderness survival (+10%), land navigation (+8%), street-wise (+10%), demon & monster lore (+20%), astronomy (+10%), basic and advanced math (+15%), first aid

(+10%), prowl (+10%), climb (+10%), swim (-10%), speaks Dragonese/Elven and Gobblely 98%, literate in Dragonese 98% and two others (+20%), and speaks four other languages (+20%), plus can select twelve additional secondary skills from any category (+10% skill bonus on all).

Level of Experience: Player characters use the same experience table as the dragon. The average NPC mage will range from 1D4+1 levels of experience, but can be lower or much higher. The experienced mage will be 2D4+2 level. The highest level characters can be incredibly dangerous, possess powerful magic, wield magic/rune weapons and are likely to command a legion of gargoyles and gurgoyles!

Size: 15 to 20 feet tall (4.6 to 6 m).

Note: There is one gargoyle mage in approximately every 20,000 gargoyles. These characters can amass a fortune in magic items, gems and precious metals. Gargoylites are one of the mage's favorite minions. They are used for reconnaissance, spying, theft and assassination.

Gargoylites

Gargoylites are a comparatively tiny, squat version of the gargoyle lords, and may be further evidence of the gargoyle's strange evolution. Physically, the creatures are unimposing. They stand only three feet (0.9 m) tall, have round, pudgy bodies, stumpy legs and small, seemingly underdeveloped wings. As for instincts, gargoylites do not share the aggressiveness and joy of combat with their larger kin, but tend toward mischief, thievery, deception and manipulation rather than wholesale destruction. They also lack the lust for power and need to dominate others, but are obsessive and psychotically greedy for precious and semi-precious stones. Their deceptive nature has made them the favorite spies of gargoyle lords and mages. Shifters, summoners and other powerful beings have also found gargoylites to be wonderful spies and allies.

Gargoylite R.C.C. Data

Alignment: Typically anarchist, but can be any.

Attributes (Gargoylite): The number of six-sided dice to roll is as indicated: I.Q. 2D6+2, M.E. 3D6+1, M.A. 3D6+2, P.S. 18+1D6, P.P. 16+1D6, P.E. 16+2D6, P.B. 2D6, Spd running 3D6, but speed flying is 1D4×10+10.

M.D.C.: Gargoylite: 1D4×100

Horror Factor: 10

P.P.E.: 4D6

Natural Abilities: The gargoylite possesses special powers very similar to the gargoyle lord. Metamorphosis into living stone can be performed three times per day, increasing M.D.C. by 100 and adds 1D6 M.D. to punches and kicks, but reduces speed by one-third. Flight is still possible in stone form, but at half speed. The duration of the transformation is limited to six hours per metamorphosis.

Other abilities include flight (regardless of how disproportionately small their wings may be), nightvision 120 ft (36.6 m; can see in total darkness), superior hawk-like vision in sunlight and owl-like vision in darkness (can see in one-tenth the light needed by a human), can leap 20 feet (6 m), gliding with their wings and bio-regenerates 6D6 M.D.C. every hour. The gargoylite can also turn invisible at will and breathe fire once per melee (4D6 M.D., range 60 feet/18.3 m).

Combat: Four attacks per melee.



Weight: 100 pounds (45 kg).

Note: Their short, stubby, little wings appear to be useless but can carry the gargoylite and up to 500 pounds with ease. However, they cannot sustain long flights (30 minutes maximum) and must take frequent rests or hitch a ride. Their skin is green, their horns tiny and their eyes yellow-orange. Their short tail is ineffectual in battle.

The Gargoyle as a Player Character

Most gargoyles are of an anarchist or evil alignment. Their anarchist society, predatory instincts, and philosophy of "might makes right" and "the strongest or meanest is the best," leaves little room for characters of a good alignment to develop. Those who persist in being good are either reclusive individuals of the lowest social level in the flock or rogues who leave or are thrown out of the tribe.

Gargoyles of an anarchist or good alignment can join forces with humans and D-bees, but this can only lead to hardship. Most Europeans (humans and D-bees) loathe all gargoyles regardless of their alignment or past good deeds. When it comes to gargoyles, many people have adopted the attitude of, "Shoot first and don't bother with questions." Few Europeans, other than gypsies and foreigners, will ever trust a gargoyle! If they don't kill the beast on sight, they will belittle and abuse the character verbally and physically. Furthermore, they will regard any humans or D-bees who associate with gargoyles as the worst kind of scum, traitors, bandits or stupid pawns of the enemy. In any case, none are worth keeping alive and they will be reviled, chased away, attacked or killed (or at least the attempt will be made). Merchants will not sell to them and people will spit in their faces rather than give them the time of day. **Note:** Asians share similar sentiments when it comes to gargoyles and their associates. However, gargoyles are far less feared and hated in North and South America, Canada, Africa and other parts of the world. In places like Atlantis, the New Phoenix Empire and other monster dominated kingdoms, they are welcomed and treated with respect and kindness.

Other gargoyles will view characters who associate with humans or who have a good alignment and high regard for all life forms as weak, stupid and inferior. Depending on their conduct, evil and war-like gargoyles may regard the character to be a traitor and a coward. This can lead to duels and, if the character loses, enslavement, imprisonment, torture or death.

Gargoyles & Technology

In most instances, the gargoyles and their minions could never create, build or repair a device as simple as a flashlight, but they know how to use and maintain it. Most importantly, they understand its basic function, value, and danger, enabling them to respond appropriately. Along these lines, the Gargoyle Empire and other supernatural beings have added mega-damage weapons and armor to their arsenal. This includes rail guns, laser rifles, vibro-blades, Kittani plasma weapons, explosives, the occasional vehicle, cybernetic implants, bionic limbs and weapons, M.O.M. conversions, power armor and robot vehicles, as well as devices that detect radio waves, radiation and life forms.

Damage: Restrained claw attack inflicts 3D6 S.D.C. damage plus P.S. bonus, full strength claw/punch or kick inflicts 2D6 M.D., power punch does 4D6 M.D., but counts as two attacks, bite does 1D6 M.D., or by weapon. Gargoylites performing a flying tackle does 1D6 M.D. and have a 50% chance of knocking the person down (victim loses one attack and initiative), but counts as two attacks.

Bonuses: In addition to physical attributes, +2 on initiative, +1 to strike, +2 to parry and dodge, +4 to dodge while in flight, +3 on all saving throws, and +10 to save vs horror factor.

Psionics: I.S.P. is 6D6. Meditation, mind block, presence sense, sense magic, see aura, object read, telepathy, resist hunger, resist fatigue and resist thirst. Equal to a 4th level psychic.

Magic: None, other than natural abilities; too lazy to study magic.

R.C.C.s: The average gargoylite is a spy/thief/scavenger.

R.C.C. Spy-Thief Skills: Escape artist (+10%), intelligence (+10%), wilderness survival (+10%), land navigation (+10%), pick locks (+10%), pick pockets (+5%), palming (+10%), concealment (+5%), prowl (+10), climb (+10%), swim (-10%), W.P. knife and W.P. energy pistol, basic math (+15%), speak Dragonese/Elven and Gobblely 98% and two other languages (+10%), plus can select six additional secondary skills from any category except electrical, mechanical, medical and science (no skill bonuses).

Level of Experience: Player characters use the same experience table as the Dog Pack. The average NPCs will range 1D4 + 1 levels, but can be virtually any level. Gargoylites of high level (9th and higher) are often revered and envied by other gargoylites as master thieves and spies and are likely to command a pack of 3D4 gargoylite thieves and a dozen gargoyles or other lesser minions.

Habitat: Same as gargoyles.

Average Life Span: 400 to 600 years, but some have been known to live over a thousand years.

Size: Three feet tall (0.9 m)

A mysterious manufacturer known as **Mindwerks** has provided the gargoyles, gurgoyles and their minions with many high-tech detectors, devices and weapons. So have the Splugorth (secretly), the New Phoenix Empire and others.

This has made the gargoyles of Europe a very different and much more dangerous foe than the traditional gargoyles recognized by most people.

In many respects it has been Triax and the NGR who have helped encourage the gargoyles to adapt and learn about technology. They began to realize that they were being consistently overpowered by the high-tech weapons and machines of the NGR. This led to them adopting the attitude of "fight fire with fire." Emperor Zerstrun would like to see his minions adapt and advance even faster.

Another contributing factor to the Gargoyle Empire's ability to attain high tech devices for war is the availability of alien weapons and technology from the rifts and from other manufacturers like Mindwerks. These forces who also either hate humans, Triax or the New German Republic, welcome the opportunity to help the gargoyles (and others). Other helpful forces have made contributions to further their own agenda or simply for their own amusement.

As the gargoyles have become more technologically astute, they have developed a greater understanding of how things work and how to recognize the power and danger of NGR war machines, especially robots. There was a time where the very concept of a robot, especially robots made to look like a gargoyle, was incomprehensible. But that time has passed.

Methods of Recognizing EIRs

The average gargoyle soldier has been trained to be on the lookout for NGR Enemy Infiltration Robots (EIRs). This has led to stricter troop identification procedures, better organization and greater alertness among the troops. The following are the four main methods of detection.

1. Observation: Alert observers can identify EIRs simply through observation. Some EIRs, particularly older models, have somewhat awkward and stiff robot-like movements. Robots also tend to be less spontaneous and more rigid in their speech and motor responses than living creatures. An EIR may also be identified by accident, especially during and after combat. Awkward, herky-jerky movements or a distorted voice may be evident after the bot has been damaged. Likewise, metal and circuits might become exposed when the fake skin is torn or burnt. Gargoyle warriors find themselves looking to see whether or not their comrades bleed when struck by shrapnel or weapons. And if he bleeds, does he seem to respond to pain? Robots often don't.

Another giveaway is uncharacteristic behavior, like not eating, avoiding participation in torture, or failing to attack an NGR soldier/human when the opportunity avails itself. All these things can contribute to the identification of EIRs.

The average, reasonably intelligent gargoyle character (I.Q. 7 or higher) has a 01-45% chance of randomly identifying an Enemy Infiltration Robot (EIR) through observation. The likelihood of discovery is increased to 01-75% if the gargoyle is actively trying to locate EIRs or when the bot has infiltrated an elite group of gargoyle lords. On the other hand, characters with

an I.Q. of six or less will only notice the most obvious signs and are only 01-25% likely to identify an undamaged EIR even when looking for one.

2. Psionics: All gargoyles have limited psionic powers. This means they can use the psychic sensitive powers of see aura, sense magic, presence sense, and telepathy to tell whether or not a suspicious gargoyle or stranger is really "alive" or a mechanical spy. However, the use of psionics to penetrate disguises (shape changers, metamorphed dragons, etc., as well as robots) is far from foolproof and is likely only to add to one's suspicions rather than deliver concrete evidence. After all, a psionic mind block prevents the success of psychic probes like see aura, detect psionics, telepathy and most others. Gargoyles are not creatures of magic, so if the power to sense magic finds a character aglow with mystic energy, it may indicate a mystic disguise, but such a detection is useless against the mechanical EIRs. Presence sense can be helpful but generally covers too wide an area. It is useless unless the test subject is carefully secluded in an area away from other higher life forms (including animals). However, a mind block might block this power too. Furthermore, the psychic sensitive is wasting precious I.S.P. on inconclusive psionic probes.

The average gargoyle has a 01-40% chance of detecting or identifying an EIR via psionic probes. The *gargoyle mage* has a wider range of powers and a greater chance of ferreting out EIRs (01-60%) and other impostors (01-70%).

3. Radio Detection: The gargoyles and brodkil have allied themselves with more technologically advanced creatures. From them they have learned to use detection devices that enable them to pick up and track radio transmissions to their source, and block transmissions, and destroy the robot.

At locations where the gargoyles are working with detection devices, the odds of randomly discovering an EIR are dramatically higher; 01-75% for random detection and 01-98% as the result of a deliberate search. Detection of radio transmissions and tracing them to the source of transmission is 01-94%.

4. Bloodletting: The simplest way to determine whether the suspect is a robot or living creature is to see if he bleeds. A character suspected of being a robot may be requested to allow himself to be cut or stabbed. Some gargoyle encampments have even started a policy where all warriors returning from the outside allow their forearm to be cut and bled to prove their identity. Since all gargoyles and gurgoyles can regenerate minor damage within an hour, few *real* monsters have any objections. The damage inflicted is seldom severe, just enough to spill some blood.

Refusal to comply will lead to a duel or brawl. If blood is drawn from the subsequent confrontation, the battle is likely to end abruptly, and the combatants will assume that the character who refused to be bled is just a jerk. If the subject of such an attack desires to continue the fight (insulted, too angry to stop, is really a cyborg, etc.) the fight can continue, with potentially deadly results.

Note: Undaunted, Triax and the NGR have found new ways to improve and disguise the Enemy Infiltration Robots. To counter the bloodletting tests, Triax created EIRs with artificial blood and nano-repair bots to stop the bleeding of fake blood and to repair minor damage. The gargoyles have not yet figured out more sophisticated means of identification such as blood

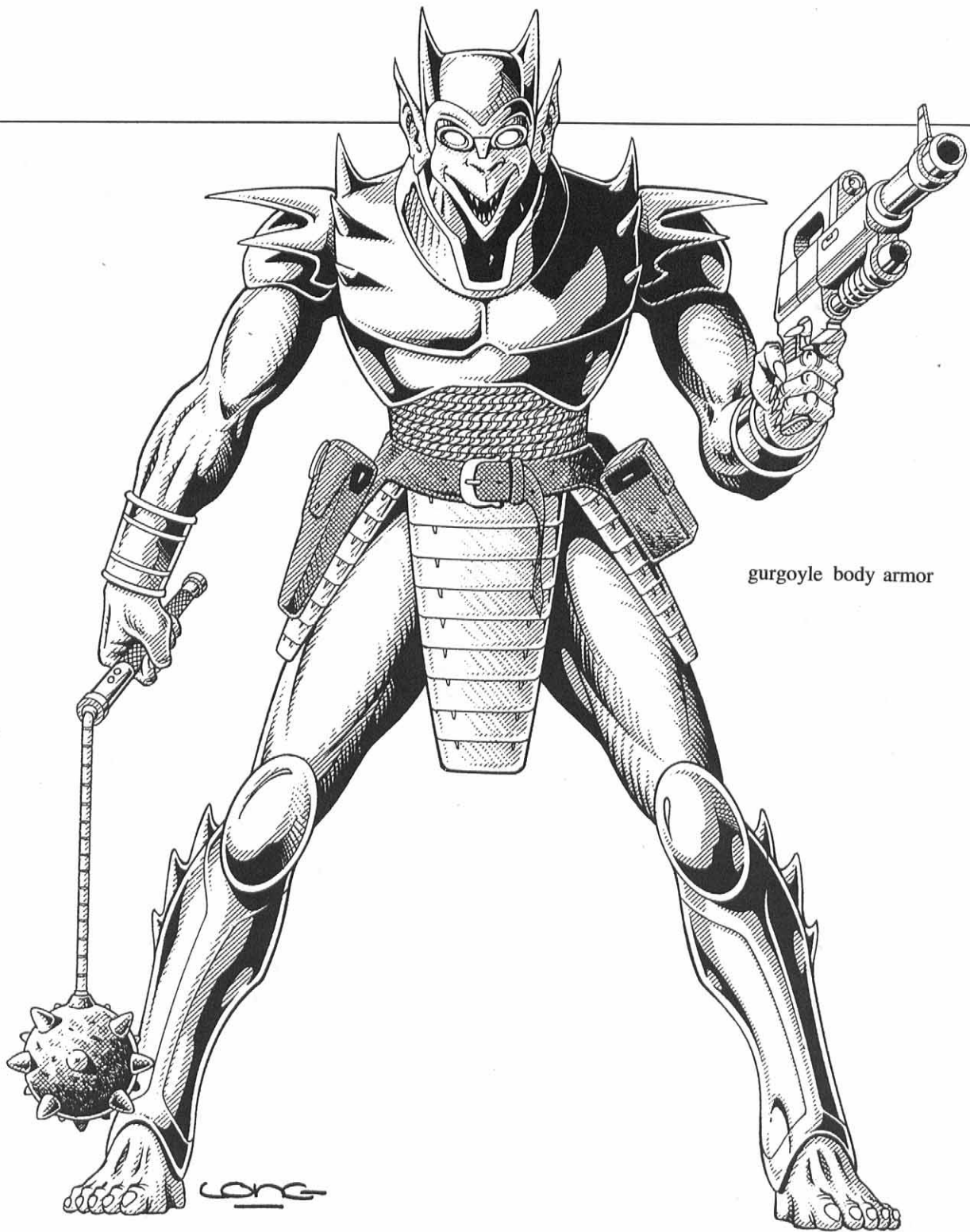

gargoyle body armor

analysis. Besides, more elaborate and time consuming testing is frequently inappropriate or impossible in the field of combat. Consequently, this ruse is reasonably effective.

In an effort to create an even more foolproof infiltration unit, Triax is developing the Enemy Infiltration Cyborg (EICs). Since the borg is part machine and part living creature, it will pass the presence sense test and most cursory psionic probes. The

human inside the machine can react quickly and spontaneously as well as display emotions, thus completely countering detection by observation. Furthermore, the cyborg can have real skin or seemingly real synthetic skin and blood, eliminating the blood-letting test. Likewise, the human operative can exercise greater cunning and discretion in the use of radio transmissions and sabotage. See the section on EIRs and EICs elsewhere in this book.

Robots & Weapons of the Gargoyle Empire

- G-10 Gurgyle Power Armor
- G-11 Gargyle Power Armor
- G-20 Avenger Bot
- G-30 Wrecker Bot
- G-40 Super Bot (see Mindwerks supplement)

Emperor Zerstrun has created an elite force of gurgyle and gargoyle warriors who use modern weapons and equipment. The following items are common to that elite force and many of the gargoyle lords/commanders. At the present time, his elite army is limited to about 50,000 troops (70% the wingless gurgyles). However, he hopes to quadruple that number in less than a year and many of the millions of other gurgyles use energy weapons, rail guns, and equipment as well as magic items.

Gargoyle Body Armor

Approximately 40% of the gurgyle army wears this body armor. Another 10% wear makeshift armor put together from the captured remnants of the enemy or other foes (basically the same stats). In both cases, the armor provides additional mega-damage protection in the field of combat, but they are not full environmental suits. Remember this armor is giant-size, for creatures 8 to 12 feet (2.4 to 3.6 m) tall.

Only 25% of the giant winged gurgyles wear body armor. Most complain that they find it too confining.

- M.D.C. 150
- Weight: 100 lbs (45 kg)
- Fair mobility, -10% prowl penalty.
- Black market cost: 40,000 credits; poor availability.
- Colors: Any

Gurgyle G-10 Power Armor

The gurgyle power armor is a full environmental suit with robot augmentation much like the human suits. It is giant-sized because the wearer is a giant. The armor has wicked, spiked shoulder plates, jet thrusters for power leaps, and a few basic weapons. The complexity of the weapons and the suit's operation have been kept to a minimum. Weapons are deliberately familiar and easy to use. They include vibro-claws for hand to hand combat, a vibro-axe, an optional hand-gun and built-in ion blasters and mini-missiles. The sensor and communication system are similar to those of the human units, but with simpler display screens and more automated systems to make the armor user friendly.

Note 1: Gargyles 15 feet tall or smaller can wear a virtually identical power armor suit, the G-11. The only difference is that the creature's wings are exposed to allow flight and greater mobility.

Note 2: The gurgyle power armor is not depicted here because it looks very similar to the giant Avenger robot which follows this description. The only physical differences between the two are that the robot vehicle is twice as big and has short legs, giving it a more squat appearance.

- Model:** G-10 Gurgyle Power Armor
G-11 Gargyle Power Armor

Class: Strategic Armor Military Assault suit

Crew: One

M.D.C. by Location:

- Shoulders/Upper arm (2) — 100 each
- * Forearms (2) — 60 each
- * Claws (2) — 30 each
- Legs (2) — 90 each
- * Ion Blasters (2; side of chest) — 20 each
- * Back Mini-Missile Launcher (1) — 30
- * Maneuvering Jets (4, small) — 15 each
- * Reinforced Helmet/Head — 100
- **Main Body — 250

* All items marked with a single asterisk are small and/or difficult targets to hit. An attacker can only hit one when he makes a *called shot*, but even then he is -4 to strike.

Destroying the helmet of the power armor means the gurgyle's head is exposed to further attacks, however, remember that the gurgyle is a mega-damage creature and can withstand at least 75 points of damage to his head.

**Depleting the M.D.C. of the main body will shut the armor down completely, rendering it useless.

Speed

Running: 100 mph (160 km) maximum. Note that the act of running does tire its operator, but at 10% of the usual fatigue rate, thanks to the robot exo-skeleton.

Leaping: Assisted by the augmenting armor the character can leap up to 50 feet (15.2 m) high or lengthwise unassisted by the thrusters. A *jet thruster assisted leap* propels the unit up to 200 feet (61 m) high or lengthwise.

Flying: Flight is not possible. Nor are high speed, continuous leaps like the Terrain Hopper. **Power System:** Nuclear; average energy life is 10 years.

Statistical Data

Height: 10 to 14 feet (3 to 4.3 m) from head to toe. Remember, this is a suit worn over the body.

Width: 8 to 12 feet (2.4 to 3.6 m)

Length: 6 feet (1.8 m)

Weight: 1.4 tons

Physical Strength: Augmentation provides bonuses; see hand to hand combat, number six.

Cargo: None

Power System: Nuclear, average energy life is 10 years.

Black Market Cost: Rarely available. 2+ million credits.

Weapon Systems

1. Ion Blasters (2): Located in the lower portion of the chest are twin ion blasters. Each is a circular style turret that can rotate in all directions 90 degrees.

Primary Purpose: Assault

Mega-Damage: 3D6 per single blast or 6D6 per simultaneous blasts from both weapons at the same target.

Range: 1200 feet (365 m)

Rate of Fire: Equal to the number of hand to hand melee actions of the pilot plus power armor bonuses.

Payload: Effectively unlimited.

2. Concealed Back Mini-Missile Launcher (1): A small mini-missile launcher, holding four (4) mini-missiles, is built into the back of the armor.

Primary Purpose: Anti-Aircraft/Anti-Power Armor

Secondary Purpose: Assault

Missile Type: Any mini-missile can be used, but standard issue is armor piercing (1D4 × 10 M.D.) or plasma (1D6 × 10). Fragmentation is seldom used by these anti-armor units.

Mega-Damage: Varies with missile type.

Range: Usually about a mile.

Rate of Fire: One at a time or volleys of two, three or four.

Payload: 4 total.

3. Vibro-Claws: Each hand is equipped with vibro-claws (giant size).

Mega-damage: 3D6 M.D. per hand strike plus the creature's normal damage for supernatural physical strength (this is not true of the larger robot vehicles).

Range: Hand to hand combat.

4. Vibro-Axe: A giant vibro-axe is standard issue. In addition to the axe blade, the spike or blades located at the top and bottom are also deadly vibro-blade appendages and inflict mega-damage. This weapon can be substituted with a Kittani plasma weapon or magic weapon.

Mega-damage: Giant Axe Blade: 4D6 M.D., secondary spikes or blades: 2D6 M.D.

Range: Hand to hand combat.

Note: A handheld weapon.

5. Energy Rifles, Light Rail Gun and other weapons can be carried and used.

6. Hand to Hand Combat: Rather than use a weapon, the pilot can engage in mega-damage hand to hand combat. The gargoyle is a supernatural creature and already inflicts mega-damage from his punches and kicks. Consequently, the damage listed below are in addition to damage inflicted by the creature's supernatural strength. Bonuses: One additional melee action/attack at experience levels one, four, and ten. +1 on initiative, +1 to parry and dodge, +3 to roll with impact, and +3 to pull punch.

Full Strength Punch — 1D6 M.D.

Power Punch — 2D6 M.D., but counts as two melee attacks.

Shoulder Butt with Spikes — 1D6 M.D.

Kick or Knee Jab with Spikes — 2D4 M.D.

Jet Assisted Leap Kick — 2D6 M.D., but counts as two melee attacks.

Body Slam/Ram — 1D4 M.D.

Jet Assisted Body Slam/Ram — 1D6 M.D.

7. Sensors & Systems of Note: Fundamentally, all the *basic* items as found in human power armor.

Gargoyle G-20 Avenger Combat Robot

This robot combat vehicle greatly resembles the gargoyle power armor except that it is larger, has stubby mechanical legs and the pilot is seated in the chest. It also uses the same basic weapon systems, only larger — which may mean greater range and/or damage capabilities.

Exclusive to the Gargoyle Empire

Model: G-20 Avenger

Class: Strategic Armor Military Assault Robot

Crew: One

M.D.C. by Location:

Shoulders/Upper arm (2) — 150 each

* Forearms (2) — 100 each

* Claws (2) — 40 each

Legs (2) — 120 each

Back Mini-Missile Launcher (1) — 75

* Ion Blasters (2; side of chest) — 30 each

* Maneuvering Jets (4, small) — 25 each

* Sensor Head — 75

* Pilot View Port — 55

**Main Body — 350

* All items marked with a single asterisk are small and/or difficult targets to hit. An attacker can only hit one when he makes a *called shot*, but even then he is -4 to strike.

Destroying the head of the power armor will eliminate all forms of optical enhancement and sensory systems. The pilot must rely on his own vision and senses. All robot combat bonuses are reduced by half! Destroying the maneuvering jet thrusters only prevents jet assisted leaps.

**Depleting the M.D.C. of the main body will shut the armor down completely, rendering it useless.

Speed

Running: 60 mph (96 km) maximum. Note that the act of running does tire its operator.

Leaping: The powerful robot legs can leap up to 20 feet (6 m) high or lengthwise unassisted by the thrusters. A *jet thruster assisted leap* propels the unit up to 100 feet (30.5 m) high and 150 feet (45.7 m) lengthwise.

Flying: Flight is not possible. Nor are high speed, continuous leaps like the Terrain Hopper.

Power System: Nuclear; average energy life is 10 years.

Statistical Data

Height: 20 feet (6 m) from head to toe.

Width: 15 feet (4.6 m)

Length: 10 feet (3 m)

Weight: 30 tons

Physical Strength: Equal to a P.S. 38

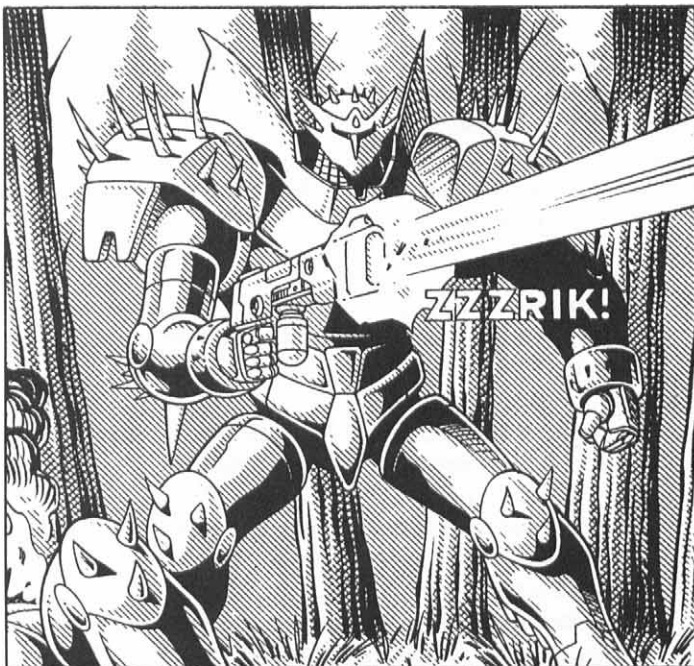

Cargo: None

Power System: Nuclear, average energy life is 10 years.

Black Market Cost: Rarely available. 18+ million credits.

Weapon Systems

- 1. Ion Blasters (2):** Located in the lower portion of the chest are twin ion blasters. Each is a circular style turret that can rotate in all directions in a 90 degree arc.

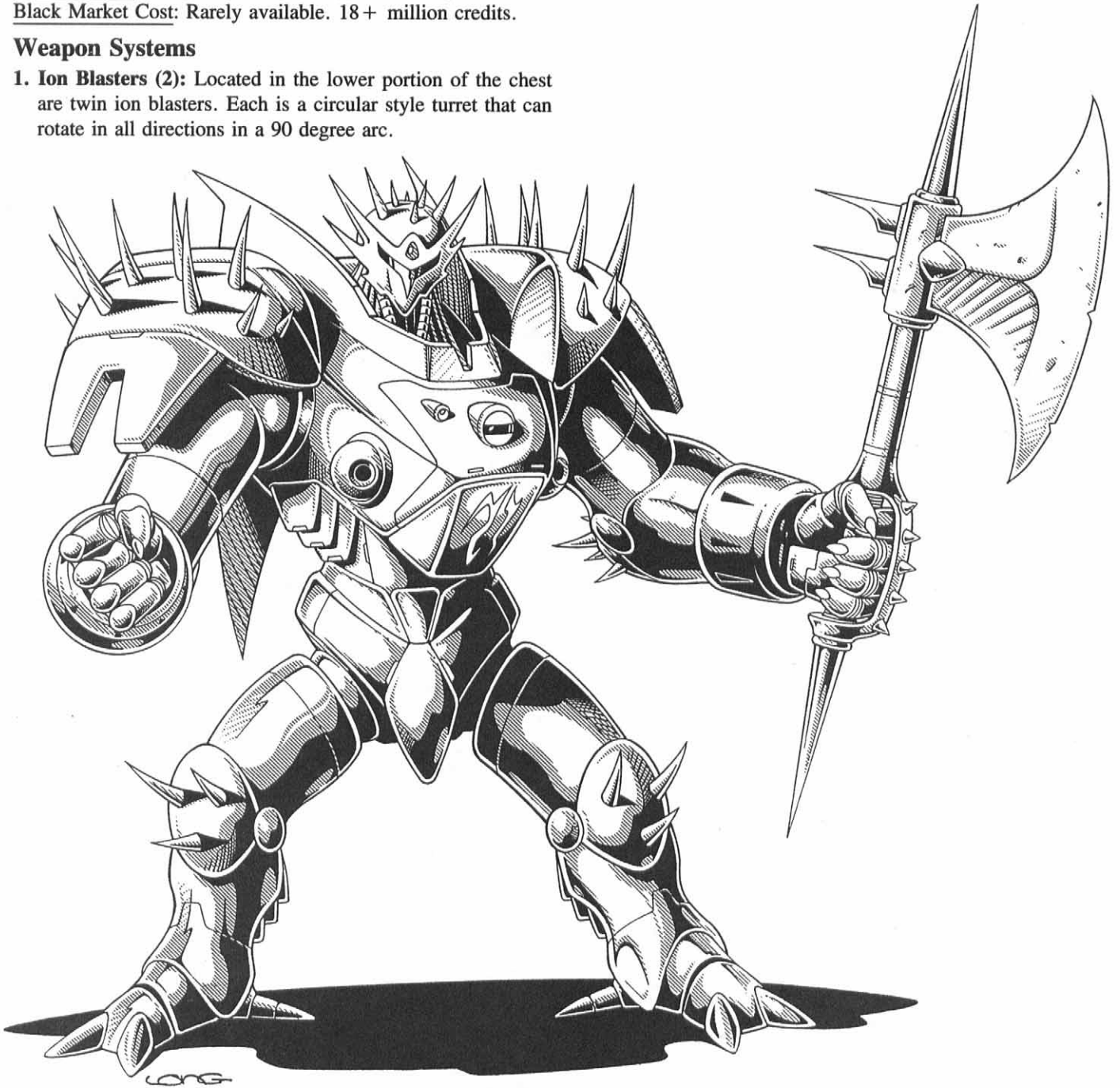

Primary Purpose: Assault

Mega-Damage: 3D6 per single blast or 6D6 per simultaneous blasts from both weapons at the same target.

Range: 2000 feet (610 m)

Rate of Fire: Equal to the number of hand to hand melee actions of the pilot plus power armor bonuses.

Payload: Effectively unlimited.

- 2. Concealed Back Mini-Missile Launcher (1):** A small mini-missile launcher, holding ten mini-missiles, is built into the back of the armor.

Primary Purpose: Anti-Aircraft/Anti-Power Armor

Secondary Purpose: Assault

Missile Type: Any mini-missile can be used, but standard issue is armor piercing (1D4 × 10 M.D.) or plasma (1D6 × 10). Frag-

mentation is seldom used by these anti-armor units.

Mega-Damage: Varies with missile type.

Range: Usually about a mile.

Rate of Fire: One at a time or volleys of two, three or four.

Payload: 10 total.

- 3. Vibro-Claws:** Each hand is equipped with vibro-claws (giant size).

Mega-damage: 3D6 M.D. per hand strike.

Range: Hand to hand combat.

- 4. Vibro-Axe:** A giant vibro-axe is standard issue. In addition to the axe blade, the spike or blades located at the top and bottom are also deadly vibro-blade appendages and inflict mega-damage. This weapon can be substituted with a Kittani plasma weapon or magic weapon.

Mega-damage: Giant Axe Blade: 4D6 M.D., secondary spikes or blades: 2D6 M.D.

Range: Hand to hand combat.

Note: A hand held weapon.

5. **Giant-Sized Energy Rifles, Rail Guns** and other weapons can be carried and used by the bot, including NGR items.

6. **Hand to Hand Combat:** Rather than use a weapon, the pilot can engage in mega-damage hand to hand combat. The gurgyle is a supernatural creature, so a normal punch or kick from one will inflict mega-damage. However, inside the robot, the pilot must rely on the mechanical strengths and abilities of the robot, not his own. Bonuses: Two additional attacks per melee round, +1 on initiative, +1 to parry, +2 to roll with impact, and +2 to pull punch.

Restrained Punch or Kick — 1D6 × 10 S.D.C.

Normal Punch — 2D6 M.D.

Power Punch — 4D6 M.D., but counts as two melee attacks.

Kick or Knee Jab with Spikes — 2D6 M.D.

Jet Assisted Leap Kick — 3D6 + 2 M.D., but counts as two melee attacks.

Body Slam/Ram — 1D6 M.D.

Jet Assisted Body Slam/Ram — 2D6 M.D.

7. **Sensors & Systems of Note:** Fundamentally, all the *basic* items as found in human robots, only simpler.

Gurgyle G-30 Wrecker Combat Robot

In addition to the Avenger combat bot, there is the even bigger and more powerful G-30 Wrecker! This robot vehicle resembles the gargoyle, complete with wings and large horns, however the wings do not provide the bot with the ability to fly. They do offer great armor protection from rear assaults and are razor sharp to slice an opponent with a quick turn or sideswipe. Missiles are fired from the chest and lasers from its fingers. A powerful ion cannon is located in the belly, but the most unusual weapon are the energy balls and chains located in the two forearms. The variety of weapons are deliberately limited and kept as simple as possible.

The big bot was specifically designed to combat the NGR's Black Knight, Devastator and other giant robots.

Exclusive to the Gargoyles Empire

Model: G-30 Wrecker

Class: Strategic Armor Military Assault Robot

Crew: One gurgyle pilot, a gunner and a gargoylite supervisor.

Note: Only the gurgyles (sometimes supervised by gargoylites) pilot the giant robot vehicles. The giant, winged gargoyles prefer to do battle in the flesh.

M.D.C. by Location:

Chest Mini-Missile Launchers (2) — 150 each

* Ion Cannon (1; belly) — 90

* Energy Ball and Chain (2) — 110 each

* Energy Ball and Chain Line (2) — 50 each

Wings (2) — 120 each

Shoulders/Upper Arms (2) — 200 each

* Forearms (2) — 150 each

* Claws/hands (2) — 60 each

Legs (2) — 220 each

Jet Thrusters (2; chest) — 120 each

* Jet Thrusters (2; lower leg) — 50 each

* Reinforced Sensor Head — 135

**Main Body — 450

* All items marked with a single asterisk are small and/or difficult targets to hit. An attacker can only hit one when he makes a *called shot*, but even then he is -4 to strike.

Destroying the head of the bot will eliminate all forms of optical enhancement and sensory systems. The pilot must rely on his own gurgyle vision and senses. All robot combat bonuses are reduced by half! Destroying the maneuvering jet thrusters only prevents jet assisted leaps.

**Depleting the M.D.C. of the main body will shut the armor down completely, rendering it useless.

Speed

Running: 50 mph (96 km) maximum. Note that the act of running does tire its operator.

Leaping: The powerful robot legs can leap up to 30 feet (9 m) high or 50 feet (15.2 m) lengthwise unassisted by the thrusters.

Jet thruster assisted leaps: Propels the unit up to 800 feet (244 m) high or lengthwise. The thrusters can also stop or reduce impact from falls.

Flying: Flight is not possible. Nor are high speed, continuous leaps like the Terrain Hopper.

Power System: Nuclear; average energy life is 10 years.

Statistical Data

Height: 30 feet (6 m) from head to toe.

Width: 15 feet (4.6 m)

Length: 10 feet (3 m)

Weight: 30 tons

Physical Strength: Equal to a P.S. 40

Cargo: None

Power System: Nuclear, average energy life is 10 years.

Black Market Cost: Not available.

Weapon Systems

1. **Ion Cannon (1):** Located in the bot's belly is a powerful ion blaster. It is a circular style turret that can rotate in all directions in a 90 degree arc.

Primary Purpose: Assault

Mega-Damage: 6D6 per blast.

Range: 3000 feet (915 m)

Rate of Fire: Equal to the number of hand to hand melee actions of the gunner.

Payload: Effectively unlimited.

2. **Concealed Chest Mini-Missile Launchers (2):** The two plates on the chest flip up top to reveal mini-missile launchers. These are also usually operated by the gunner.

Primary Purpose: Anti-Aircraft/Anti-Power Armor

Secondary Purpose: Assault

Missile Type: Any mini-missile can be used, but standard issue is armor piercing (1D4 × 10 M.D.) or plasma (1D6 × 10). Fragmentation is seldom used by these anti-armor units.

Mega-Damage: Varies with missile type.

Range: Usually about a mile.

Rate of Fire: One at a time or volleys of two, three or four.

Payload: 48 total; 24 in each chest launcher.

3. **Laser Fingers (4):** On each hand are two fingers that conceal medium lasers. Point and shoot.

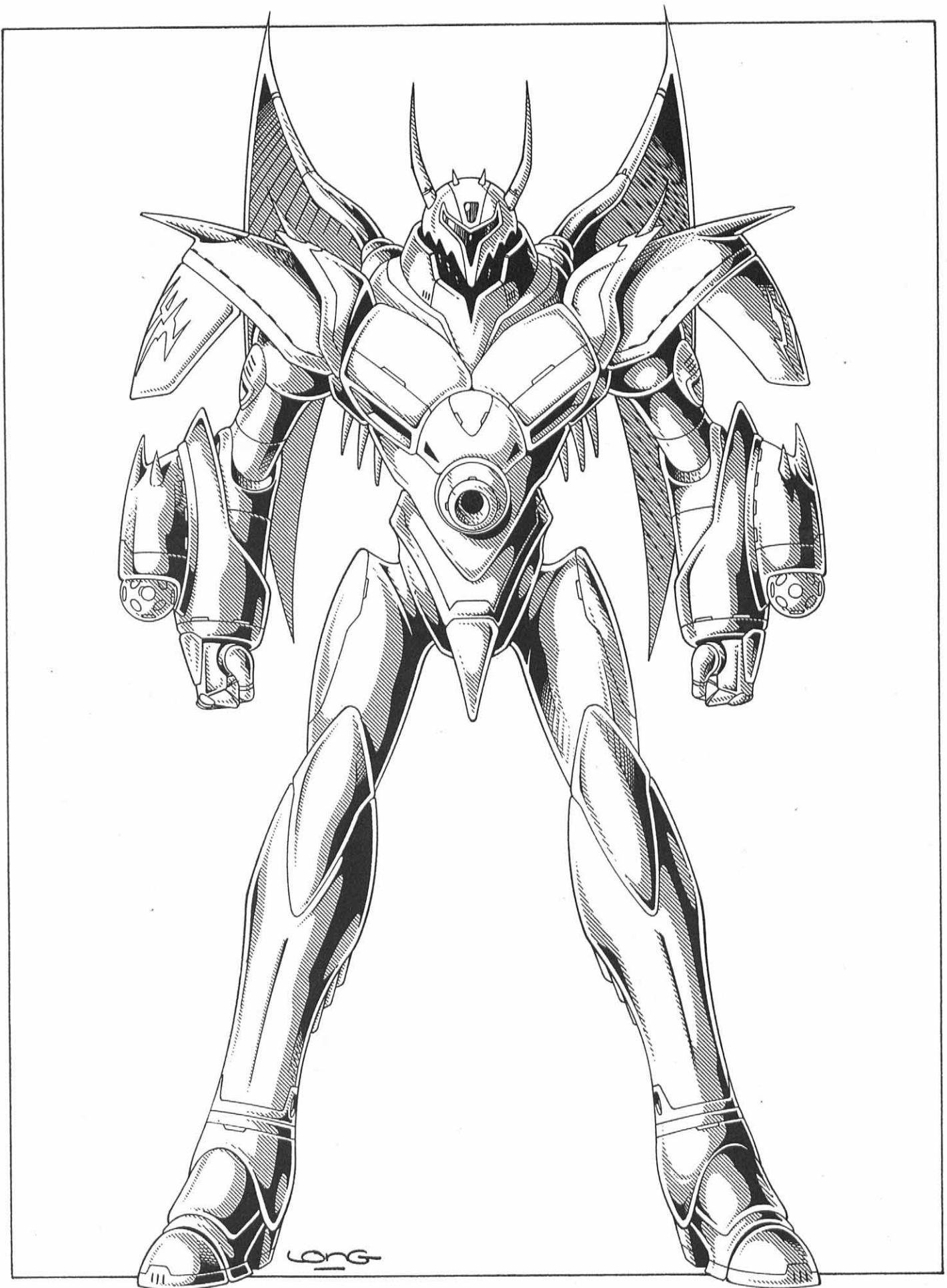

Primary Purpose: Assault

Mega-Damage: 2D6 per blast or 4D6 per double simultaneous blast. No more than two finger lasers can be fired simultaneously at the same target with any measure of accuracy (unless at point-blank range).

Range: 1200 feet (366 m)

Rate of Fire: Equal to the number of hand to hand melee actions of the gunner.

Payload: Effectively unlimited.

4. Retractable Energy Ball and Chain (2): The ball shaped nodules in the forearms are energy spheres attached to long, extendable and retractable lines and function like giant balls and chains. In many respects, they are giant robot versions of the neural blast whip, only they inflict much more damage.

Like the neural blast whip, this energy weapon releases a charge that temporarily short-circuits the nervous system whenever it strikes an opponent with either the ball or the energized cable. This weapon is especially effective against other supernatural beings because in this case, the charge or blast is a powerful electrical jolt. Striking unarmored humans will kill them. Unarmored mega-damage creatures may be stunned. Those in body armor or power armor may have a temporary system failure. Like the neural blast whip, the energy ball and chain are designed to kill!

Mega-Damage: 4D6 M.D. per strike. This weapon is an M.D.C. structure and can be used to parry M.D. attacks from robots and power armor.

Stun Penalties for Mega-Damage Creatures: Using this weapon against mega-damage beings such as demons and dragons inflicts the same amounts of mega-damage, and double damage to beings who are vulnerable to electricity. The jolt will cause the victim to lose initiative and one melee action/attack per each strike of the ball. Furthermore, the creature will be momentarily dazed for the rest of that melee and is -2 to strike, parry, and dodge.

Characters in power armor or environmental body armor suffer damage, and there is a 01-40% chance of targeting, radar or communications getting temporarily knocked out for 1D4 minutes. However, the character inside the armor is grounded and insulated so he is impervious to being dazed.

Robot vehicles only suffer mega-damage from the hits.

Save vs Being Dazed: The save roll is the same as saving against non-lethal poison, '16 or higher. The character must save each time he or she is struck. A successful save means the victim of the attack is NOT dazed and suffers no penalties.

Bonuses: +2 to strike and parry.

5. Giant-Sized Energy weapons, electro-mace and others can be carried and used by the bot, including NGR items.

6. Hand to Hand Combat: Rather than use a weapon, the pilot can engage in mega-damage hand to hand combat. The gargoyle is a supernatural creature, so a normal punch or kick from one will inflict mega-damage. However, inside the robot, the pilot must rely on the mechanical strengths and abilities of the robot, not his own. Bonuses: Two additional attacks per melee round, +1 on initiative, +1 to parry, +2 to roll with impact, and +2 to pull punch.

Restrained Punch or Kick — 1D4 M.D.

Normal Punch — 3D6 M.D.

Power Punch — 6D6 M.D., but counts as two melee attacks.

Normal Kick — 3D6 M.D.

Jet Assisted Leap Kick — 6D6 M.D., but counts as two melee attacks.

Body Slam/Ram — 3D6 M.D.

Jet Assisted Body Slam/Ram — 4D6 M.D.

Body Throw — 2D4 M.D.

Head Butt — 2D6 M.D.

7. Sensors & Systems of Note: Fundamentally, all the *basic* items as found in human robots, only simpler.

Gargoyle Weapons

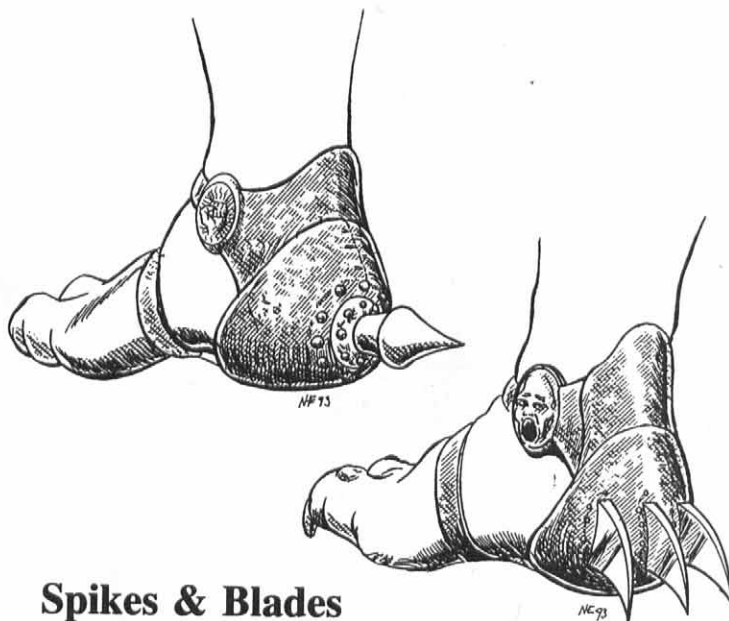

Spikes & Blades

Gargoyles frequently wear combat apparel that adds to the potential damage of hand to hand attacks as described below.

Gargoyles and gurgoyles are especially fond of blade weapons and spikes and adorn their armor and weapons with them. Spiked brass knuckles, footwear, knee pads, shoulder pads, and gauntlets may all be lined with sharp spikes or blades. These add 1D4 M.D. plus the damage inflicted by the character's supernatural strength to any attack that utilizes them.

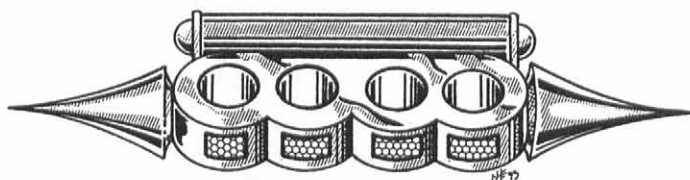

Blaster Knuckle Spikes

This is an energy weapon variation on brass knuckles. First, the knuckles add damage to punches and the spikes can be used to stab. However, every time the knuckle portion or spikes strike they emit a low intensity energy burst which inflicts additional damage and jolts one's opponent.

Weight: 5 lbs (2.3 kg)

Mega-Damage: Normal blunt damage (blaster turned off): 1D4

M.D. plus the damage inflicted by the gargoyle's supernatural P.S. or 1D6 M.D. from a spike.

Damage with the blaster turned on: 2D4 M.D. plus the damage inflicted by the gargoyle's supernatural P.S. or 2D6 M.D. from a spike.

Additional Penalties: The startled victim of the blast also loses initiative (if he had it in the first place) and is -2 to roll with a punch or impact from any attack with the knuckles.

Rate of Fire: Hand to hand punches

Effective Range: Arm's length

Payload: 32 blasts/jolts; recharges after two hours. A blast is expended every time the knuckle weapon strikes something. The blaster can be turned on and off as desired.

Black Market Cost: 15,000 credits. Fair availability. Remember, this is a giant-size weapon.

Wing & Tail Blades

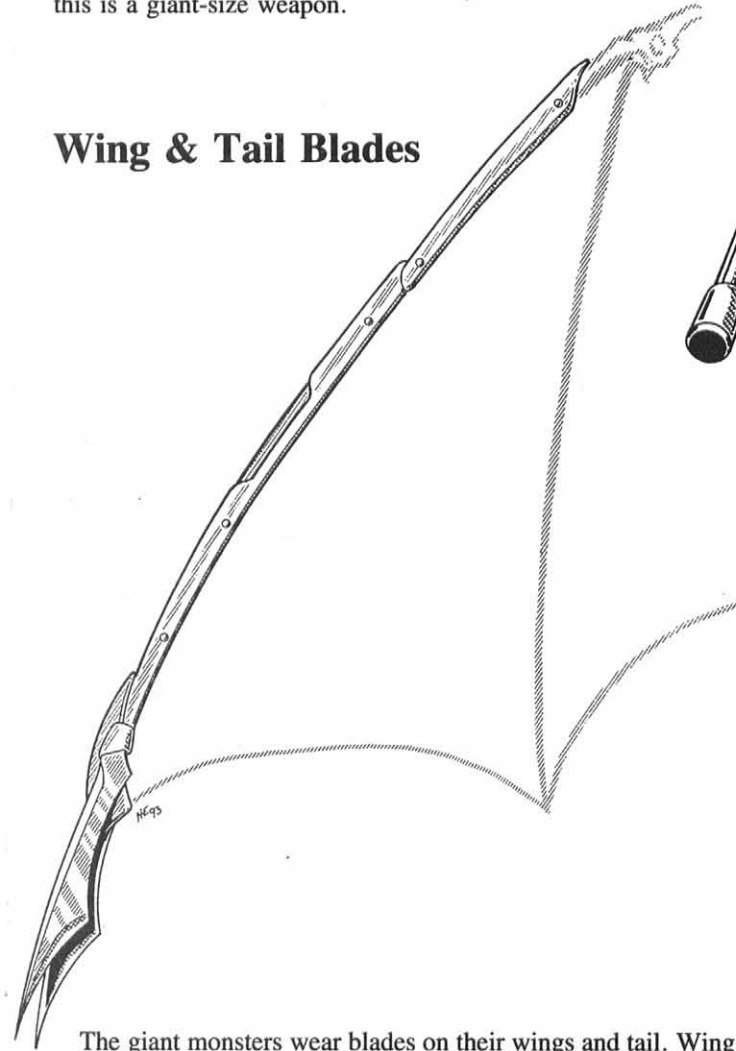

The giant monsters wear blades on their wings and tail. Wing blades are used to rake across the body of an enemy as the gargoyle flies past him. Tail blades are used like a whip to stab and slash an opponent. Ordinary types add 1D6 M.D. to the damage inflicted by the creature's supernatural strength. However, some have started using vibro-blades which adds 2D6 M.D. plus the damage from their supernatural strength. **Note:** Gargoyle Lords may use magic blades instead; rune weapons, techno-wizard creations and others.

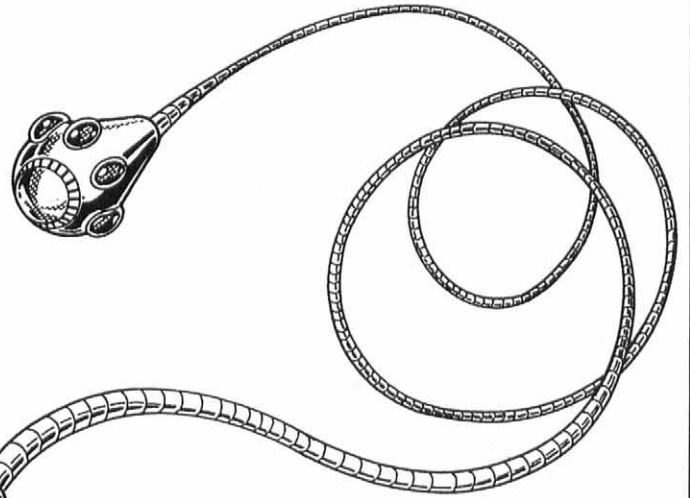

Blaster Neural Whip

Another close combat weapon used by gargoyles and other giants is the blaster neural whip. Like the neural mace, this energy weapon releases an energy charge that temporarily short-circuits the nervous system whenever it strikes an opponent with the ball at the end of the whip. There is a chance of rendering an unarmored person unconscious, but even if the individual remains conscious the charge will impair his movement. Unlike the neural mace which is designed to stun an opponent for the purpose of capture, the whip is intended to kill! As a result, it inflicts mega-damage.

Physical damage from the whip is 2D4 M.D. plus damage from the supernatural strength of its user. Note that the whip is an M.D.C. structure and can be used to parry M.D. attacks from robots and power armor.

Stun Penalties for the Victim protected by half armor, magic armor or the Armor of Ithan spell: The body armor absorbs the mega-damage, but the character inside is still shocked and suffers the following penalties: -8 to strike, parry, and dodge for 2D4 melees. The duration of the impairment is increased 2D4 melees for every hit by the whip (also roll each time to see if knocked unconscious). Remember, stun is only effective against characters who are not protected by environmental armor.

Using this weapon against mega-damage beings such as demons and dragons will inflict the same amounts of mega-damage, but has different stun penalties. The jolt will cause the creature to only lose initiative and one melee action/attack per strike of the whip. Save vs The Blaster Neural Whip is the same as saving against non-lethal poison, 16 or higher. The character must save each time he or she is struck. A successful save means the character is not stunned and only loses initiative.

Note: The whip is ineffective against environmental M.D.C. body armor, power armor, and robots. It is effective against cyborgs not completely enclosed in full environmental armor, half suits or armor like those worn by the gargoyles, or body armor without a helmet (it's not fully environmental without the helmet attached), other gargoyles, demons and mega-damage creatures.



Gargoyle Firebrand Spear

The firebrand spear is a techno-wizard device. The spear's shaft is made of metal with fine strands of copper and silver imbedded in it. The spearhead is a blood red crystal.

The magic is activated by thought and 7 P.P.E. or 15 I.S.P. When activated, the spearhead glows red like a hot ember and is enveloped with heat vapors. When it strikes an opponent, there is a blast as if he was struck by a fireball or plasma blast!

Weight: 15 lbs (6.8 kg)

Mega-Damage: Note that the spear can be used as a mega-damage weapon to stab and parry whether it is magically charged or not. The giant, uncharged weapon inflicts 2D6 M.D. plus the damage inflicted by the gargoyle's supernatural P.S. (1D6 M.D. when the spear is human-size).

Firebrand Damage: When magically charged, the weapon inflicts 5D6 M.D. plus the damage inflicted by the gargoyle's supernatural P.S.. There is a 01-50% chance that combustibles will catch fire.

Rate of Fire: Equal to the warrior's attacks per melee.

Effective Range: Hand to hand, or 500 feet (153 m) when thrown by a gargoyle or gurgyle (about 200 feet/61 m for human-sized spears thrown by a human). However, a thrown spear must be physically retrieved or it is lost.

Payload: Depends on the P.P.E. and/or I.S.P. of the warrior.

Each plasma/fire strike costs 15 I.S.P. or 7 P.P.E. points.

Market Cost: 75,000 to 100,000 credits whether the spear is human or giant size.

Triax Electro-Mace & Neural Mace

The gargoyles love the electro-mace used by the X-2500 Black Knight. Its capture or purchase is a prize. Gargoyles and gurgylites sometimes use the neural mace. See the Triax weapon section for the descriptions.

WR-12 Giant Ion Pistol

This is an energy pistol designed for giant humanoids. The appearance is that of a Pre-Rifts sub-machinegun with a short shoulder stock

Weight: 10 lbs (4.5 kg)

Mega-Damage: 2D6 M.D.

Rate of Fire: Standard, see Modern Weapon Proficiency Section.

Effective Range: 600 feet (183 m)

Payload: 30 shots per E-clip.

Market Cost: 10,000 credits. Fair availability.

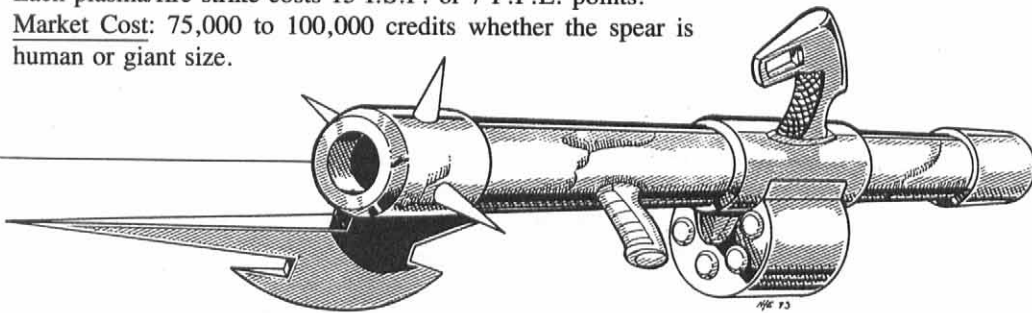

Gargoyle Grenade Mace

At first glance, this giant-sized weapon looks like a spiked battle axe, but upon closer scrutiny one can see that it also has an opening at the top, a round magazine, handle and trigger. The weapon can be used as a mace/morning star, axe or projectile weapon!

Weight: 25 lbs (11 kg)

Mega-Damage: Blunt/Mace: 1D6 plus supernatural P.S. mega-damage.

Chopping/Axe: 1D6 plus supernatural P.S. mega-damage.

Grenade: 5D6 M.D. each to everything in a 20 foot radius.

Rate of Fire: Grenade: one per melee action; point, squeeze the trigger and boom.

Effective Range: 400 feet (122 m)

Payload: Grenades: Six. They can be reloaded in one melee round (15 seconds).

Black Market Cost: 20,000 credits for the weapon and 200 credits for each grenade. Fair availability. Remember, this is a giant-size weapon (although the grenades are like large bullets to the gargoyles).

Gargoyle Laser Mace

Looks identical to the grenade mace except that it has an energy-clip sticking out of it rather than a round magazine. As the name suggests, it fires a laser beam.

Weight: 20 lbs (9 kg)

Mega-Damage: Blunt/Mace: 1D6 plus supernatural P.S. mega-damage.

Chopping/Axe: 1D6 plus supernatural P.S. mega-damage.

Laser: 3D6 M.D. per shot.

Rate of Fire: Standard, see Modern Weapon Proficiency Section.

Effective Range: 800 feet (244 m)

Payload: 20 shots from an FSE-clip or 10 from a short clip.

Black Market Cost: 25,000 credits for the weapon. Fair availability. Remember, this is a giant-size weapon.

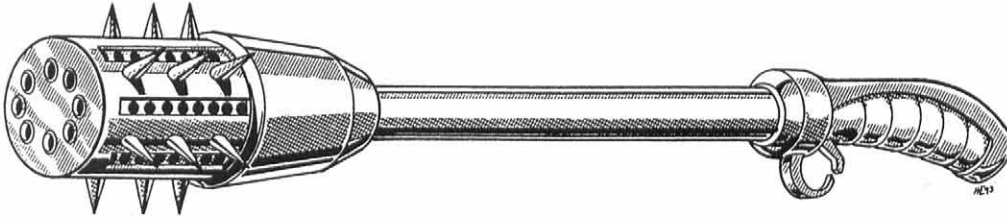

Super-Eight Pistol Mace

This is another giant mace-like item that is also a projectile weapon. It can be used in hand to hand combat or fire explosive cartridges similar to the Triax pump guns (which are what inspired this design).

Weight: 25 lbs (11 kg)

Mega-Damage: Blunt/Mace: 1D6 plus supernatural P.S. mega-damage.

Explosive Bullets (large): 1D4 M.D. per single shot, 4D4 M.D. from a short burst (4 rounds) or 5D6 M.D. from a full burst (8 rounds).

Rate of Fire: Standard, see Modern Weapon Proficiency Section.

Effective Range: 800 feet (244 m)

Payload: 48 shots or six full bursts.

Black Market Cost: 15,000 credits for the weapon and 100 credits per box of 48 rounds. Fair availability. Remember, this is a giant-size weapon.

WR-100 Giant Laser Rifle

A heavy laser rifle designed for giant humanoid. Comes standard with an infrared, telescopic sight.

Weight: 20 lbs (9 kg)

Mega-Damage: 3D6 M.D. per blast.

Rate of Fire: Standard, see Modern Weapon Proficiency Section.

Maximum Effective Range: 1600 feet (488 m)

Payload: 20 shots per E-clip.

Special Bonus: +1 to strike (so an aimed shot is +5).

Black Market Cost: 25,000 credits. Fair availability.

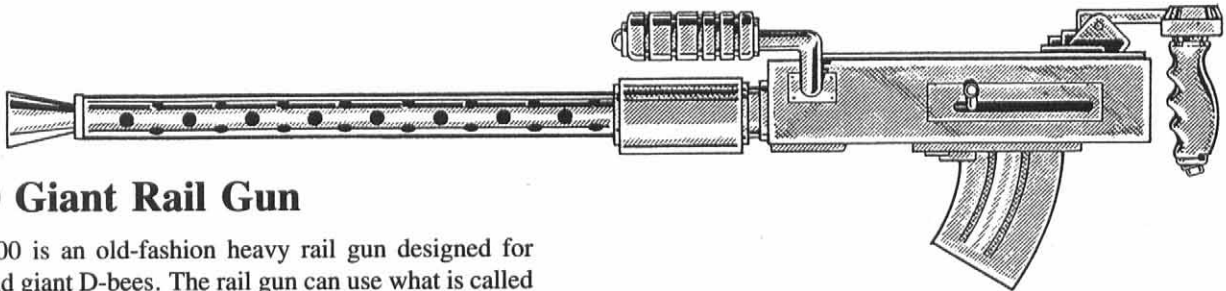

WR-200 Giant Rail Gun

The WR-200 is an old-fashioned heavy rail gun designed for borks, bots and giant D-bees. The rail gun can use what is called a short clip with 300 rounds (10 bursts) or a belt feed drum containing 3000 rounds (100 bursts).

Primary Purpose: Assault

Secondary Purpose: Defense

Weight: Gun: 250 lbs (112.5 kg). An ammo-drum is another 250 lbs (112 kg) and is carried as a large backpack.

Mega-Damage: A full damage burst fires 30 rounds and inflicts 1D4 × 10 M.D. A short burst of 15 rounds does 3D6 M.D.; single shots are not possible.

Rate of Fire: Equal to number of combined hand to hand attacks (usually 4-8).

Maximum Effective Range: 6000 feet (1828 m)

Payload: The short clip holds 300 rounds and is capable of firing 10 full damage bursts (30 rounds) or 20 half damage short bursts (15 rounds).

The 3000 round drum is capable of firing 100 full damage bursts or 200 half damage bursts (15 rounds). Reloading a drum will take the average gargoyle 1D4 minutes, but a field mechanic could do it in under a minute. A strength of 28 or higher is required to handle the gun and the drum.

Black Market Cost: 65,000 credits. Good availability.

Kittani Laser Wrist Blasters

A pair of wristbands similar to the ones used by the Altara warrior women. Mini-lasers with a magic power pack worn on the back. See the center figure depicted on the cover of **Rifts**.

Mega-Damage: 2D6 M.D. per blast.

Range: 1200 feet (366 m)

Rate of Fire: Up to five blasts per melee.

Payload: 60 blasts, backpack recharges completely in four hours.

Note: Splugorth design.

Market Price: 22,000 credits. Poor availability.

Note: Cost and stats are the same for both giant and man-sized weapons.

Kittani Double Blade Plasma Axe

An energy weapon used for in-close combat originally designed for use with Kittani power armor. The weapon can be used as a bludgeon or energized to slice through mega-damage structures like a hot knife through butter. It can also fire a short-range burst of plasma. Unlike the power armor version, this weapon draws its power from an E-clip.

Primary Purpose: Assault

Weight: 10 lbs (4.5 kg)

Mega-Damage (Human-size): 3D6 M.D. per axe strike or 6D6 M.D. per plasma blast. Each blast drains 10 minutes from the power supply. 3D6 S.D.C. damage when not energized.

Mega-Damage (Giant-size): 1D4 × 10 M.D. per axe strike and per plasma blast. Each blast drains 10 minutes from the power supply. 3D6 S.D.C. damage when not energized.

Rate of Fire: Equal to the number of hand to hand attacks (usually 4-6).

Maximum Effective Range: Close combat or plasma blast of 100 ft (30.5 m).

Payload: 60 minutes or less per clip, depending on the number of plasma blasts fired. A maximum of six plasma blasts.

Market Price: 32,000 credits for human-size (this is still a large weapon and suitable for small gurgoyles) and 45,000 credits for giant-size. Good availability. A favorite among the winged gargoyles and large gurgoyles.

Kittani Plasma Sword

A sword that radiates plasma energy like the Kittani axe.

Primary Purpose: Assault

Weight: 3 lbs (1.35 kg)

Mega-Damage: 2D6 M.D. per sword strike or 4D6 M.D. per plasma blast. Each blast drains 10 minutes from the power supply. Or 2D6 + 2 S.D.C. damage when not energized.

Rate of Fire: Equal to the number of hand to hand attacks (usually 4-6).

Maximum Effective Range: Close combat or plasma blast of 100 ft (30.5 m).

Payload: 60 minutes or less per clip, depending on the number of plasma blasts fired. A maximum of six plasma blasts.

Market Price: 28,000 credits. Good availability.

Note: Cost and stats are the same for both giant and man-sized weapons.

Kittani Energy Lance

A handheld, long-range, precision laser weapon. Designed for use by borgs, bots and power armor. Only fires single shots and is +2 to strike on called shots.

Primary Purpose: Sniper; long range.

Weight: 20 lbs (9 kg).

Mega-Damage: 3D6 M.D. per single shot at long range. The weapon can be adjusted to half the range and twice the damage (6D6 M.D.). Or 2D4 M.D. as a stabbing lance or blunt weapon.

Rate of Fire: Equal to combined number of hand to hand attacks of the operator (usually 4-6).

Maximum Effective Range: 6000 feet (1828 m) or 3000 (915 m)

Payload: 40 shots; recharges after four hours. Fair availability.

A favorite among the winged gargoyles.

Market Price: 39,000 credits. Poor availability.

Note: Cost and stats are the same for both giant and man-sized weapons.

Other Weapons

Remember, the gargoyles can use any of the NGR/Triax, Coalition or other weapons designed to be used by giant D-bees, larger than human-sized robots, power armor and borgs, including the TX-41 Pulse Rifle, rail guns and others. They also use techno-wizard devices, rune weapons and other magic items.

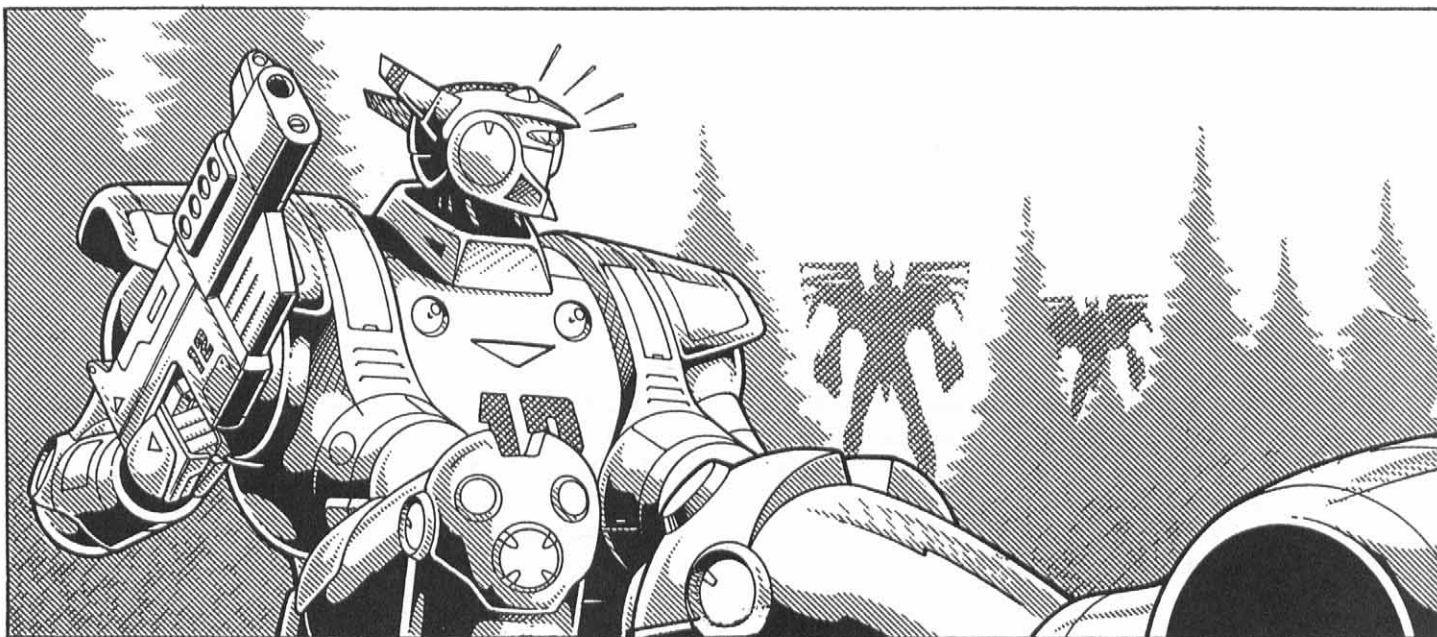

People & Places

A Quick Overview of Europe

The **New German Republic** has laid claim to the countries once known as East and West Germany and the Netherlands/Amsterdam. However, it is also a force in Poland and has waged military and humanitarian campaigns in Austria, Belgium, Switzerland, Hungary, Czechoslovakia, Poland and Scandinavia. These are the last (and often fading) bastions of humankind in Europe. If the Republic should ever decide to expand its borders, these are the countries most likely to be claimed or rebuilt, pretty much in the order they are listed. As it is, the NGR is having a difficult enough time preserving its own country and helping other human cities and kingdoms whenever they can.

Along the southern and eastern borders of the NGR are what they call **Monsters Zones** — territories dominated by inhuman D-bees, monsters and supernatural beings. The immediate neighboring countries of Belgium, Switzerland, Northern France, Northern Italy, and Austria are under the direct control of the **Gargoyle Empire**. Much of Poland and most of Czechoslovakia has fallen to the **Brodkil Empire**.

A Basic Population Breakdown of

Intelligent Life Forms in Europe

- 22% Humans
- 38% D-bees
- 8% Gargoyles
- 2% Brodkil
- 8% Supernatural Predators
- 14% So-called Demons/Supernatural Beings
- 4% Faerie Folk
- 1% Dragons & Creatures of Magic
- 0.1% Gods and Alien Intelligences
- 2.9% Others

The Wilderness

Magic and the supernatural are commonplace in the wilderness. Fairies can be seen playing in fields of flowers, birds share the sky with gryphons, dragons and gargoyles, and monsters roam the land. Some of these monsters are animals from other worlds who have come to Earth through dimensional rifts. Others are intelligent but inhuman looking aliens from other dimensions. Some have been torn from their homes by dimensional anomalies. Other are runaway slaves while still others are dimensional travelers, explorers and merchants. Some come in peace. Other come as invaders or tormentors.

The majority of Europe is unpopulated wilderness. Here and there are lightly populated pockets of civilization with many diverse peoples and cultures. Most are D-bees and most are of a low technology. The hordes of millions of gargoyles is an anomaly. Rarely has any one creature come to dominate one

part of the world. However, adventurers can stumble across supernatural menaces and creatures of magic just about anywhere in Europe (and most of the Rifts world for that matter). There are thousands of tiny kingdoms and millions of tiny villages, inhabited, ruled or plagued by demons and monsters. Vampires, werewolves, hell hounds, ghouls, poltergeists, entities, dragons, baal-rogs, giant worms, demon lords and many other horrific creatures stalk the people of Europe. Even god-like beings who claim to be the deities of ancient myth walk the earth, sometimes helping, sometimes hurting, and sometimes creating mischief or extracting their own inhuman pleasures.

For the most part, the demons, gods and supernatural menaces are lone villains or work in small groups. For example, an enterprising team of adventurers or mercenaries may come across a human or D-bee village enslaved by a dragon or demon. The creature is likely to be powerful, but is not likely to have more than a dozen or so supernatural minions at its command. It doesn't need an army because it possesses incredible magic and/or supernatural powers. Thus, the creature and a handful of superhuman minions are the equivalent of a small human army or a platoon of bots or borgs. Ordinary people don't have a chance against them, but highly skilled modern soldiers or a powerful group of adventurers may be a different story.

Remember too, that many supernatural monsters are instinctive predatory hunters with moderate intelligence. They regard all humans and D-bees within their territory as prey and/or playthings. These monsters, even if there is a pack of them, are not likely to be organized, possess technology, or command minions. Instead they are like wild animals that hunt and kill for food and pleasure. They rely entirely on their instincts, supernatural powers, magic and cunning.

These are the denizens that haunt Europe.

France & Spain

The country once known as France is a dangerous, forest covered wasteland. It is filled with faerie folk, ghosts, goblins, and monsters of all kinds. The Gargoyle Empire has claimed the **French Alps**, but other than the mountains, no one tribe, kingdom or race of beings have officially laid claim to the rest of the country.

The ruins of the once great city known as **Paris** are occupied by a flock of gargoyles who are not official members of the Empire. Perhaps the most notable landmark is the six Eiffel Towers. The gargoyles who live in the ruins of Paris found the still standing Eiffel Tower made an excellent habitat and were inspired to erect five, crude, lopsided versions of their own (they are found scattered around the original). Paris is also inhabited by other denizens of evil, including Blood Druids.

The mysterious **Blood Druids** are said to have a powerful hold over France and Spain, but they actually appear to be a small cult of necromantic fanatics. If the druids have any one stronghold or place of influence, it remains a mystery, at least to the NGR.

The north of France and much of its coastline (what's left of it from the rising ocean) was once the site of hundreds of ancient stone megaliths. Today, it is a virtual mystic highway with scores

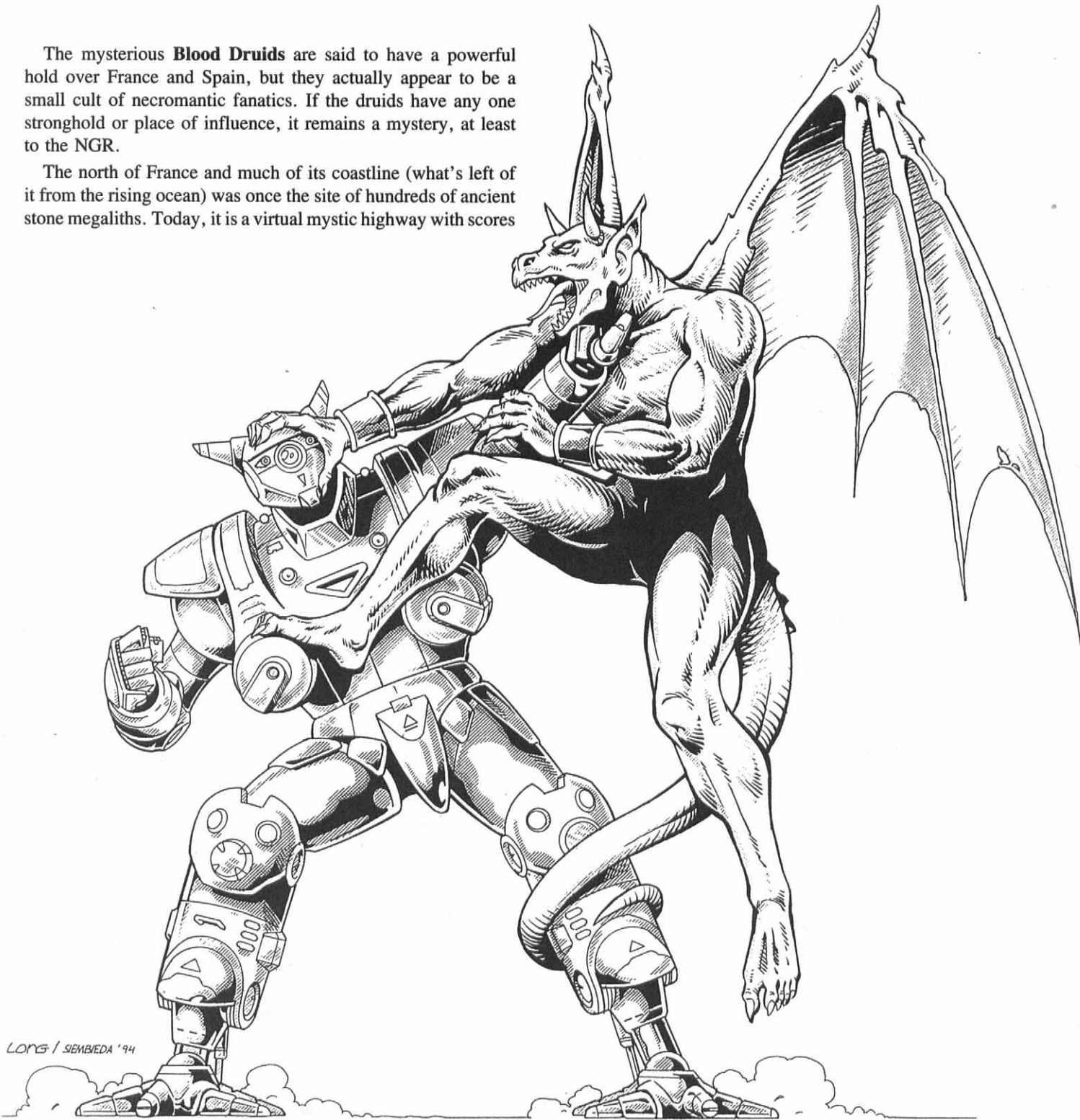

of ley lines, nexus junctions and places of magic. Dimensional rifts randomly opening are a common occurrence and one of the reasons it remains an unclaimed wilderness.

Spain is very similar to France in that it is mainly a forested wilderness with vast uninhabited regions and no one force claiming it as their land. Population centers, primarily of non-humans, are starting to appear along the Mediterranean Sea.

Italy

When the ley lines erupted, Atlantis reappeared, the oceans rose, and human civilization was obliterated from Italy and most coastal communities along the Mediterranean, including Sicily,

Greece, Crete, Turkey, Syria, Israel, and parts of Yugoslavia. Civilization has recently exploded in that region, with at least a half dozen different peoples, human and non-humans, making bids for power and land.

One of the most notable forces are the *wolfen*, giant humanoid wolves reminiscent of the Coalition's dog boys. They come from a dimension known as the **Palladium World**. They are hard working, strong, resilient, organized and superb warriors. Ironically, their style of combat, native garb, customs and penchant for military conquest is very much like the ancient Roman Empire. The similarities are so striking that some scholars have speculated that a Roman legion may have been rifted to the

Palladium world thousands of years ago and the survivors taught the wolves their ways. Other scholars insist it is nothing more than an example of parallel development.

Romania & Hungary

Most of Romania and Hungary is wilderness. What humans and D-bees exist are peasant folk, gypsies and farmers. Although high-tech equipment, mercenaries and travelers can be encountered, there are no modern cities found in either country.

Land of the Undead?

The occasional appearance of a vampire or a small group of vampires is to be expected from monster-ridden Europe, however, these demons have never been able to become entrenched in this part of the world. This is largely because the four major forces in Europe, humans, gargoyles, brodkil and Minions of Splugorth, actively hunt and destroy them. In addition, most other people, including D-bees, recognize the danger vampires represent and also try to destroy them. Still, there is an increasing number of rumors coming out of Romania that vampires are quietly building a community(s) for themselves.

Gypsies are convinced that vampires inhabit the Romanian highlands and stay away from that territory. To lend some credence to the gypsies' stories, the NGR military recently had a skirmish with four gypsies turned into the undead and with another vampire that was stalking the streets of Dusseldorf. These were the first encounters with vampires in over 30 years. **Note:** The Brodkil and Poles are unaware of any vampire presence in Poland. German leaders are confident that the NGR is free of the monsters as well. The Gargoyle Empire slays any they find.

A Precautionary Investigation

Perhaps the only thing gargoyles and humans have in common is their fear and hatred of vampires. Gargoyles destroy them whenever and wherever they are discovered. The Gargoyle Empire, Lord Splynncryth of Atlantis, the NGR, True Atlanteans, and even the Coalition States are increasingly concerned with reports of vampire activity and have dispatched several teams to investigate the matter. As a result, adventurers may encounter True Atlantean Undead Slayers, Coalition soldiers, NGR intelligence operatives, gargoyles from the Empire, and local vampire hunters (peasants, D-bee warriors, mercenaries, etc.).

Lord Splynncryth has gone so far as to send extermination squads to hunt down and eliminate the undead. These hunting parties can include any mix of Splugorth minions, including Kittani warriors, Overlords, Sunaj assassins and gargoyles loyal to Atlantis. The Minions of Splugorth had troops eradicate a fledgling community of vampires established in Hungary shortly after arriving on Earth (the Splugorth and vampire intelligences are ancient rivals). At the time, they were confident that all had been exterminated, but vampires are a cunning pest and one or two may have escaped to rebuild. More likely, these vampires are a new batch come to spread their infestation from South America or another dimension.

The Gargoyle Empire also reported to their Splugorth friends a few encounters with small gangs of vampires and one tiny community around the time of the NGR's Bloody Campaign, 3 P.A. These encounters were in the Transylvanian Alps near the

Yugoslavian border, but the gargoyles also believe they had destroyed them all.

The Real Vampire Story

A few different vampire intelligences would like to establish kingdoms on Earth. One in particular, Vladapar, had mounted two invasions in Earth's past. One was when the original Atlantis was a supreme power and crushed him, and the other was in more recent human history and led to the legends of Count Dracula and modern vampire lore.

His attempts to reclaim Romania have been crushed by opposition on every front. Despite Vladapar's best efforts, there are currently less than one thousand vampires scattered throughout Romania and perhaps another couple hundred in the rest of Europe and parts of Russia. At this rate, it will be hundreds of years (if ever) before his legion is large enough to bring his physical body to Earth. Still, Vladapar and his undead minions represent a danger to humans and other life forms.

Poland

The country once known as Poland is an unpopulated expanse of forest, mountains and grasslands. Like Germany, it had originally survived the Great Cataclysm very well when compared to the rest of Europe. However, the invasions by gargoyles, brodkil and other supernatural forces have shattered cities and slain tens of millions. Hundreds of Post-Rifts cities lay in ruin or have been conquered by inhuman monsters.

The nerve center of human civilization in Poland is a cluster of smaller cities and villages around the industrial giant Poznan. This area is known as the Poznan Collective. Its close proximity to Germany, a formal alliance with that nation, regular trade and military assistance have all been contributing factors in its survival.

Poznan is a city of 1.9 million with another 3.7 million in the surrounding Collective. As incredible as it may sound, they represent roughly half of the remaining human population in all of Poland! Millions of Poles have fled to the comparative safety of the New German Republic, but for every person who has survived there are 50 dead. The populations of entire cities have been obliterated by assaults from the gargoyles, brodkil and other supernatural forces. Virtually every Polish family has lost loved ones to demons and D-bees. This has made the Poles hate and despise non-humans more than the people of the NGR. With rare exception, the typical human will look upon any non-human as a dangerous enemy. They definitely ascribe to the philosophy of "shoot first and don't bother with questions," when it comes to dealing with the supernatural beings and, to a lesser degree, D-bees and strangers. Sadly, most, especially those living in the wilderness, see life as a matter of kill or be killed.

Wilderness folk tend to be extremely secretive and avoid contact with strangers. They will not share information, hide the best for themselves, and are cool and aloof. They are so paranoid of outsiders that they frequently even hide their women and children, along with their valuables, when strangers come to town. It is a rarity for these people to accept outsiders into their community, even though they may hire mercenaries and adventurers to protect them or to provide services.

The City of Poznan — Poland

Compared to the NGR, Poznan and the communities around it are third world kingdoms. The tech levels vary from the mid-20th Century to the mid-21st Century. The Collective is reasonably self-sufficient and strong, but under constant threat of invasion by the brodkil and other supernatural enemies.

Poznan refines metal, manufactures vehicles, building materials, low-end electronics, and components for the NGR. This includes items for bots, weapons, vehicles and housing. They are modestly familiar with advanced robotics and cybernetics, but only have one major manufacturer who is fundamentally a subsidiary of Triax Industries.

Like the NGR, Poznan and most of the Collective are places of extremes. The wealthy live in the parts of town that sparkle with chrome, silver and gold. At Poznan itself, the center of town is comparatively clean and pleasant. A giant underground complex is located beneath a dozen downtown skyscrapers and scores of apartment buildings, workshops and businesses. The subterranean portion of the city is expansive, with subway tunnels reaching out like tendrils to several of the smaller communities in the Collective. Located underground are great warehouses of surplus food, materials and supplies, for it is underground that they are safest from the giant monsters who invade their land. It is also under the earth where the wealthy and powerful make their homes. There are parks, fountains, theaters, art galleries, shopping-malls, and all the luxuries and services one would expect to find at any major metropolis.

By contrast, much of the surface portions of the city are dark and soiled, covered in soot from the belching factories. Most inhabitants don't seem to notice or mind. The factories are their life's blood. Considering how many other cities have fallen to the enemy over the last few decades, they are glad to be alive and free. The poorest neighborhoods are typically the closest to the factories or on the farthest outskirts of the city, which are the most vulnerable to enemy attack. The sky is hazy and grey from factory smoke. Little, one and two story homes are covered in dirt and soot. The streets are littered with paper, debris and garbage waiting for disposal (garbage disposal is typically 1D4 weeks late). Vermin scamper across roads and down alleyways. Human vermin, such as thieves, muggers, drug dealers, black marketeers, cyber-snatchers, the occasional D-bee, and other low-lives, lurk in the shadows.

Cybernetic and Juicer augmentation are the rage at the Poznan Collective. Drugs and booze are commonplace, used by many people to forget their hardships and the constant danger from monsters. Jape and Juicier augmentation are also easy to acquire. M.O.M. implants are scarce, but one can get them if he has enough money and makes the right connections. There seems to be a body-chop-shop every few blocks, especially in the poorest sections of town where the black market and organized crime have their strongest holds. These are dangerous places. The cyber-doc is often an evil, self-serving villain who enlists the services of criminals, cyber-snatchers, junkies and mercenaries.

Gangs of all kinds roam the streets looking for excitement, trouble and plunder. Some of the most dangerous are those who use augmenting drugs and who've undergone Juicer or Crazies/

M.O.M. conversions. The worst are the cyber-snatchers. These are the ghoulish punks who make a living by robbing people of their valuable cybernetic prosthetics and implants. Since retrieving most types of cybernetic/bionic items requires surgery, most cyber-snatchers are cutthroats and murderers who kill and mutilate their victims. They sell their ill-gotten spoils to unscrupulous body-chop-shops or the black market. Even the gypsies have too much pride and respect for life and fair play to associate with cyber-snatchers or deal in their wares.

Despite the criminal element and despair of the people, Poznan and the surrounding communities can be interesting places to visit, particularly if one stays away from trouble areas and brigands. Unlike the tiny wilderness communities, Poznan and many of the communities welcome mercenaries and adventurers. They are even reasonably tolerant of D-bees who look extremely human, such as elves, True Atlanteans, and mutants, as well as practitioners of magic. They are also accepting of dog boys and delighted to see visitors from the Coalition States.

The communities in the Poznan Collective offer visitors some fine hotels, entertainment, magic shops, fortune-tellers, healers, antique shops, legitimate cyber-shops, automobile and robot garages (repairs and upgrades), nightclubs, dance halls, taverns, and gambling establishments (legal and illegal). They also offer bold and resourceful individuals interesting opportunities. Many of the businesses (especially the black market, although the characters may not know they are dealing with criminals) are always looking for temporary help. The most common areas of service are in protection (guard a person, place, valuables, etc.), escort (bodyguard), delivery, surveillance, private detective work, repossession, wilderness scouting, wilderness recovery/salvage, exploration and similar. Some of the more blatantly criminal opportunities include robbery, acts of revenge, assassination, intimidation, extortion, delivering or guarding contraband and so on.

Military Troops

The Poznan Military: The Poznan Collective has a small high-tech army of trained soldiers. 60% of the weapons, armor and equipment have been acquired from the NGR or are knock-offs of NGR/Triax designs.

288 Crazies

500 Juicers

800 Power Armor Troops

1100 Cyborgs

6000 Foot soldiers

12,000 mercenaries (A large range of different warriors including robot vehicle pilots, borgs, headhunters, wilderness scouts, and men of magic. 40% are ex-NGR soldiers.)

NGR Troops at the Poznan Collective: The NGR, unable to turn its back on its fellow humans and hoping to prevent all of Poland from falling to supernatural monsters, has two armored divisions stationed at **Poznan** and a medium-sized military base is located at **Pleszew**, between the Poznan Collective and the smaller industrial community at **Wroclaw**.

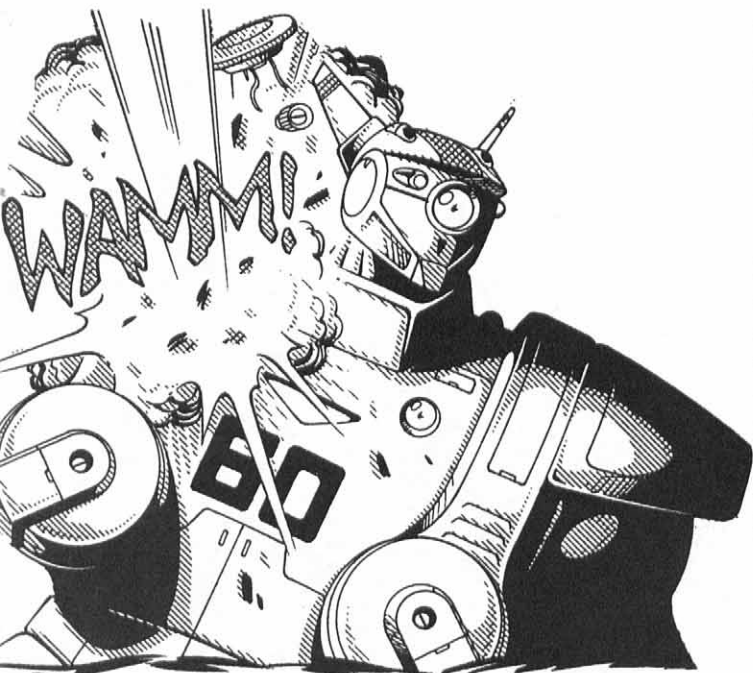

Pleszew Troops:

- 6000 Infantry soldiers (half are Poles)
- 3000 DV-12 Dyna-bots
- 1000 DV-40 Hunter/Killer Drones
- 24 EIR-20 Gargoyle Drones
- 12 EIR-30 Gargoylite Drones
- 1000 X-535 Jagers
- 500 X-60 Flankers
- 288 X-10A Predators
- 144 X-622 Bugs
- 96 X-821 Land Crabs
- 96 X-1000 Dyna-Max
- 96 X-545 Super Jagers
- 24 X-2500 Dragonwings
- 6 X-2700 Black Knights
- 1 X-5000 Devastator
- 96 XM-180 Drop Ships
- 12 XM-250 Medical Hover Stations
- 48 XM-270 Mosquito Air ships
- 24 XM-275 Lightning Combat Jets
- 96 XM-300 Terror Mini-Tanks
- 48 XM-330 Phantom Hover Tanks

Wroclaw — Poland

Wroclaw is another industrial city, with several smaller communities around it. Wroclaw is only 100 miles (160 km) south of the Poznan Collective and is protected by the NGR troops at **Pleszew**, roughly 50 miles (80 km) northeast. It is a quieter and less dangerous place, with half a million residents. The land around the city is mostly farmland and orchards, with scattered villages that account for another 100,000 people. To the south and east are the domain of the brodkil.

The Gargoyle Empire

The Gargoyle Empire claims the countries once known as Germany, Belgium, Switzerland, Austria, Hungary, Czechoslovakia, northern Italy, northern Yugoslavia and the series of mountains known as the Alps. However, their main forces are

in the mountains of Switzerland, Austria, northern Italy and parts of Yugoslavia. They are strongest and most numerous in the mountains; specifically the French, Swiss, Italian and Bavarian Alps. Also see the section about gargoyles elsewhere in this book.

Gargoyles in Poland

The Gargoyle Empire has acknowledged the Brodkil's claim to all of Poland and have withdrawn all of their troops. Only a couple thousand gargoyles remain. Of these, most are tiny splinter groups, rogues, bandits and stragglers. This is a blessing for the Poznan Collective, Wroclaw and tiny human villages. At least for the moment, they are not under siege by demonic creatures.

Meanwhile, the brodkil have been concentrating on activities in southeastern Poland and Czechoslovakia and have left western Poland unmolested.

Note: The gargoyles and brodkil have enjoyed a lasting alliance for nearly 120 years and continue to support each other. If one or the other should need aid they will be quick to respond. There are no feelings of rivalry or suspicion between the two.

Gypsies

Gypsies are human and D-bee nomads who wander all over Europe and as far east as Mongolia and northern China. However, they feel most at home in the countries of France, Switzerland, Germany, Austria, Poland, Hungary, and Russia. Also see the section describing gypsy O.C.C.s.

The Brodkil Empire

Poland & Czechoslovakia

The Brodkil Empire lays claim to all of the countries once known as Poland and Czechoslovakia, but really only dominates the northern half of Czechoslovakia and the southwestern corner of Poland.

Historically, the giant warriors have always participated in military campaigns with their gargoyle allies, and have seldom launched any major campaigns on their own. In fact, most humans and D-bees believe that without the gargoyles' help, the brodkil would never have conquered the territories they now occupy. The brodkil continue to be quiet and reclusive, limiting their activities to small areas of Poland and Czechoslovakia and away from the NGR. Their numbers, compared to the gargoyles, are small. The NGR estimates not more than five million are scattered in seemingly disjointed tribes and communities. One NGR general has been so bold as to claim that he could destroy the Brodkil Empire in six months. Thus, the leaders of the NGR continue to focus on the Gargoyle Empire and ignore the brodkil. A potentially fatal mistake.

What the NGR doesn't realize is that the brodkil are more organized, aggressive and militarily oriented than the gargoyles. They have been reclusive and non-threatening for a reason. They've been plotting and preparing for years. Brodkil love technology. They have mastered the basic understanding and use of technology more completely than the gargoyles or any other supernatural monsters that plague the region. This is especially true in regard to weapons and cybernetics! The brodkil

have always had a natural affinity for weapons and have adapted to high-tech gizmos with amazing intuition. They may not know how to turn on a television set or drive a car, but they know how to operate, clean and maintain energy weapons. At least half are armed with energy weapons and rail guns, and all fight with ferocity. In addition, brodkil have always gotten along with members of other monster races and have had a formidable number of lesser demons, simvan and other monstrous D-bees join their armies.

Furthermore, the brodkils' true numbers are nearly twice what NGR intelligence believes they are, with over a million hiding in the Czech and Carpathian mountains. Tens of thousands have submitted to bionic augmentation — mainly a bionic limb or two, three or four bionic weapons and a half dozen implants or other mechanical improvements. Hundreds of thousands have undergone Mind Over Matter (M.O.M.) experiments, conversions and augmentation. The person responsible for this insanity is the mysterious **Angel of Death**, the mad genius behind **Mindwerks**. The NGR, the people of Poland and surrounding countries have no idea what's in store for them, because these augmented brodkil are unlike anything they have ever encountered. **Publisher's Note:** Unfortunately, the reader will also have to wait until the publication of the **Mindwerks Sourcebook** to learn the dark secrets and technological horrors unleashed by Mindwerks.

Meanwhile the brodkil wait and plot like anxious children, brimming with excitement. Soon they will be ready to strike. Soon they will be ready to take their place with their gargoyle allies as the second greatest military power in Europe (excluding the NGR, of course). Together they shall rise and crush the New German Republic once and for all. Humankind and all lesser beings shall be their slaves. Such are the dreams of conquest and glory that dance in the minds of the European brodkil.

The Brodkil R.C.C.

The following is excerpted from **Rifts Sourcebook One**

The Brodkil are a race of superhuman giants who are apparently of supernatural origin. Like the gargoyles, they do not possess significant powers other than superhuman strength, a mega-damage body, and the ability to turn invisible.

The brodkil are incredibly aggressive and war-like. Normally, they are nomadic scavengers with no technology of their own nor organized society. The typical tribe will range from 20 to 100, while raiding parties can be as few as three and seldom more than 25. However, these brodkil have learned from the gargoyles and are quietly building an empire.

The nomadic warriors travel the wilderness, attacking travelers, villages, and towns to plunder what they need. They are fair hunters but would rather steal livestock or waylay and eat some unsuspecting travelers than spend time stalking wild animals. The brodkil are meat-eating predators who feast on the flesh of humanoids, as well as animals.

These demons are lazy and hate to learn complicated skills or skills that do not directly impact on their lives as warriors and thieves. Consequently, most of their skills and interests are combat oriented.



The Brodkil

Alignment: Selfish or Evil.

Horror Factor: 10

Size: Approximately 9 feet (2.7 m). **Weight:** 350 lbs (103 kg)

Typical Attributes: I.Q.: 10, M.E.: 18, M.A.: 12, P.S.: 30, P.P.: 18, P.E. 20, P.B.: 5, Spd. 22

Player Character Attributes: The number of dice to roll are as follows: I.Q.: 2D6+3, M.E.: 4D6, M.A.: 3D6+1, P.S.: 5D6+5, P.P.: 3D6+4, P.E.: 4D6, P.B.: 2D6, Spd.: 6D6

P.P.E.: 2D4 × 10, **I.S.P.:** None

Mega-Damage Creature: Main Body: 250

Combat Data: Five attacks per melee. +4 to strike, +6 to parry and dodge, +15 S.D.C. damage, +2 on initiative, +2 to save vs psionics and +4 to save vs magic.

Damage:

Restrained Punch: 4D6+15 (P.S.) S.D.C.

Full Strength Punch: 2D6 M.D.

Power Punch: 4D6 M.D. (two attacks)

Bionic Arm Power Punch: 3D6 M.D.

Tear: 2D6 M.D.

Crush: 1D6 M.D.

Bite: 1D4 M.D.

Body Flip/Throw: 6D6+15 (P.S.) S.D.C.

Natural Abilities: M.D.C. body, impervious to normal fire and cold, prowl 40%, turn invisible at will, bio-regenerate 2D6 M.D.C. per hour.

Magic Powers: None.

Psionics: None.

Skills of Note: All are usually equal to about fourth level. Hand to hand basic or expert, boxing, wrestling, climbing, tracking, intelligence, radio: basic, pilot hover craft, three languages, W.P. knife, sword, blunt, and energy rifle. Game Masters may add skills from the categories of weapon proficiencies, communications, technical, domestic, and wilderness (no bonuses).

Bionics: Any bionic augmentation will always be partial reconstruction, never full conversion. The most common bionic features include bionic lungs, one or two arms, occasionally an extra limb (tail or tentacle), forearm blasters, vibro-blades, and retractable claws/blades. Common implants include the gyro-compass, amplified hearing, multi-optic systems, laser eye, and similar.

Weapons: Favorite weapons include energy rifles, rail guns, vibro-blades, Kittani plasma weapons, bionics, and magic weapons. They also use binoculars and optical enhancements.

Note: Because the Brodkil have no supernatural, psionic, or magic powers, they can benefit from bionic weapons and implants without ill effect other than losing the ability to turn invisible. The Brodkil love bionics and M.O.M. implants.

Gene-Splicers

Gene-splacers are mysterious aliens who have appeared in Europe in the last ten years. They are ugly, tall humanoids of mysterious origin and intent. They seem to be explorers and scientists who are experimenting on the many different life forms found on Earth (including brodkil). They seem to wield an alien technology superior to Triax and are masters of genetic engineering. At least for the last year, there seems to be less than a few hundred, usually sequestered away in secluded areas. So far they seem to have limited their range of operation and genetic experiments to the countries once known as Germany, Austria, and Czechoslovakia. Like alien Doctor Franksteins, they create genetic mutations and monsters that make the Coalition States' dog boys look like child's play.

Publisher's Note: Unfortunately, gamers will have to wait until the publication of the **Mindwerks Sourcebook** (coming soon) to get all the inside information regarding the gene-splacers and their nightmarish creations.

Notes Concerning Non-Human Good Guys & D-Bees

Simvan monster riders are common in this part of the world, especially in Hungary, Romania, and Russia. They can be helpful in controlling and directing non-intelligent monsters. Simvan are respected and feared as fearless warriors by many of the D-Bee wilderness communities.

Unfortunately, there are good and evil simvan. Evil monster riders and those who have suffered persecution at the hands of humans, have allied themselves with the gargoyles, brodkil and other non-human forces. See **Rifts Sourcebook One** (or the **Mindwerks Sourcebook**) for a complete description about the Simvan.

True Atlantean Undead Slayers are independent champions obsessed with killing vampires, zombies, mummies, animated skeletons, necromancers, dybuks, and all types of ghouls and undead monsters. The character may also exterminate other types of monsters if he feels like it, or if he see the monsters as a serious danger to innocent lives. Most (90%) are NOT affiliated with either side (NGR or Gargoyles). This means they are typically free to walk unmolested in territories dominated by humans and monsters. They are also employed by both humans and monsters to track and exterminate vampires. They are respected and feared.

Undead Slayers also serve as bearers of news, rumors and information. They frequently trade their unique services and information for food, supplies and a place to sleep. Many small wilderness communities revere the undead slayers as heroes and lavish all sorts of comforts and rewards on them for their help and protection. See **Rifts Atlantis** for a complete description about all True Atlanteans & the Splugorth.

Psi-Stalkers can be encountered throughout Europe, but are especially common in the monster-ridden Black Forest, Germany, Austria and France. They can be good or evil, but most are considered good guys because they hunt supernatural monsters. Only rogues associate with gargoyles and other demonic creatures. 1D6 may join forces with an undead slayer in an organized and methodical mission of destruction. Most operate as mercs or lone hunters. Those who travel or live within a community of psi-stalkers will hunt in packs of 2D6 and sometimes as large as 1D6 × 10. Psi-stalkers call their tribes or communities "packs." Like a wolf pack, the community is nomadic, always travelling and hunting, but usually within a particular territory they consider their own. The typical radius of their territory is 100 to 200 miles (160 to 320 km).

They allow other races and "independent" psi-stalkers to co-exist in their territory as long as they do not cause serious damage to the wilderness and wildlife. Many small human and D-bee villagers and woodsmen don't even know they share their land with psi-stalkers. Other psi-stalker tribes are allowed to travel through another pack's territory and even pursue prey from their territory into another pack's area, without conflict. However, if they try to conquer that territory or attack the people who live in the area (including non-stalkers), a bloody war will erupt until the invader flees (they may be pursued and destroyed or their land conquered and added to the other's territory). This is a rarity.

Note: Psi-stalkers can sense another pack's territory and most respect it. Sometimes two to six packs will join forces to fight a common enemy. A typical pack/tribe will have 40 to 240 members. Independent psi-stalkers are one or two stalkers who travel alone or as a pair outside a pack. They are considered equal to an outsider and cannot join a pack without a trial by ritual combat and must start as a subservient member of the adopting pack.

Splugorth Military Advisors: The Splugorth try to keep their hands in everything and have taken a great interest in the conflicts centering around the Gargoyle Empire and the New German Republic. The Minions of Splugorth (Atlantis) have sent merchants and observers, military advisors to help the gargoyles, advisors and troops to spy on the gargoyles, and teams to keep an eye on the NGR, gene-splacers, brodkil and others. They'd like to find out about Mindwerks too. Troops mainly consist of

2D4 Overlords or Kittani in power armor and 1D4 Power Lords or gargoyles led by a High-Lord or Conservator.

The **Coalition States** have ambassadors, observers and troops stationed at the New German Republic. They also have small investigative teams operating in Germany and surrounding territories. Some are known to the NGR but others are spies and intelligence agents unknown to them. They may be disguised as mercenaries, merchants or adventurers.

Temporal Raiders, warriors and wizards are also found here and there throughout Europe. Most are lone wolf adventurers, but occasionally, one will settle down to protect or rule a village, city or kingdom. See **Rifts England** for details.

Note: The Mindwerks Sourcebook will include more data on new D-bees, gene-splicers, genetic monsters, brodkil, Emperor Zerstrun, and M.O.M. implants, as well as more details about the New German Republic and major cities such as Bonn, Stuttgart, Dusseldorf, and Ruhr.

German Language Translations

To add to the gaming flavor, we've provided a number of English to German translations. The words in the parentheses are the pronunciation key. **Note:** "der" is pronounced dare. "die" is pronounced "dee" and "das" is pronounced dahs.

Angel of death der Vernichtungsendel (fair nick tungs eng ell) or der Todesengel (toad ess eng ell)

Annihilation/Extermination: die Vernichtung (fair nick tung – rhymes with Jung)

Annihilation/Destruction: die Zerstoerung (tsair shtoohr ung)

Battle, The: der Schlacht (shlahkt)

Black Forest: der Schwarzwald (shvarts vahld)

Black Knight: der Schwartzritter (shvarts ritt air)

Bug/beetle: der Kaefer (kay fur)

Brain: das Gehirn (ga heern)

Castle: das Schloss (shloss) or die Burg (boorg)

City: die Stadt (shtaht)

Cybernetics: die Kybernetik (koo bare net eek)

Danger: die Gefahr (ga far)

Dragonwing(s): der(die) Drachenfluegel (drah ken flew gell)

Death: der Tod (toad)

Demon: der Daemon (day mun)

Devil: der Teufel (toy full)

Devastation: die Verwuestung (fair voost ung)

Electricity: der Strom (shtrohm)

Electronics: die Elektronik (ell ek tron eek)

Factory: die Fabrik (fah breek)

Glitter Boy or **Glittering Brat:** das Glitzernknaabe (glits airnk nob eh) or **Sparkling Boy:** der Funkelnjunge (foon keln yung eh)

Genocide/Extermination of a race: die Ausrottung (ows rot ung)

Gypsy: das Zigeuner (tsigoin air)

Havoc Creator: der Verwuestungshoepfer (fair voost ung shoop fair)

Head: der Kopf (kowpf)

Human: der Mensch (men tsh)

Insect: die Wanze/das Insekt (vahnts eh/een tsehkt)

Intellect: der Intellekt (een teh lehkt)

Job: die Arbeit (are bite)

Marauder or Robber: der Raeuber (roy bare)

Mechanism: das Getriebe (ga treeb eh)

Mindwerks/Brain Factory: das Gehirnwerk (ga heern vairk) or die Verstandfabrik (fer shtahnd fah breek)

Minion(s): der(die) Günstling(e) (guun stling eh)

Monster: das Ungeheuer (oon ga hoi air)

Mountain: der Berg (baigr)

Predator (animal): der Raubtier (rowb teer)

Production: das Werk (vairk)

Robot: der Roboter (robe ott air)

Rift, The: der Spalt (shpahlt)

Rifts: die Spalte (shpahlt eh)

River: der Fluss

Sense: der Sinn (tsin)

Spirit: der Geist (rhymes with iced)

Super Trooper: der Ueberkavallerist (oob air kava lare ist)

Terrain Hopper: der Gelaendehuepfender (gah lane deh hoop fen dare)

Thief: der Dieb (deeb)

Thought: der Gedanke (ga dahn keh)

Village: das Dorf (dorf)

Water: das Wasser (vass air)

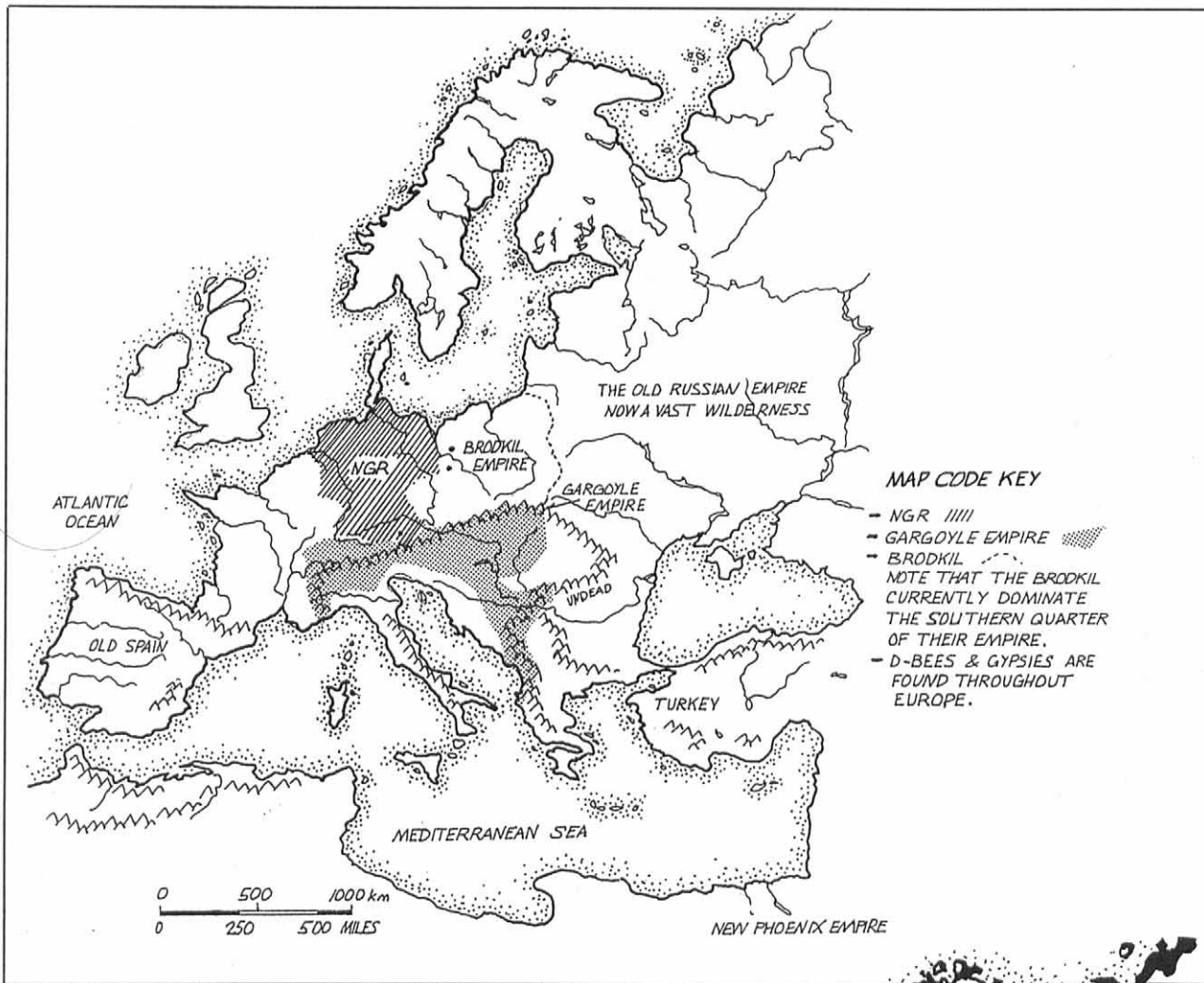

PRE-RIFTS EUROPE

THE BLACK AREAS ARE UNDERWATER SINCE THE REAPPEARANCE OF ATLANTIS.

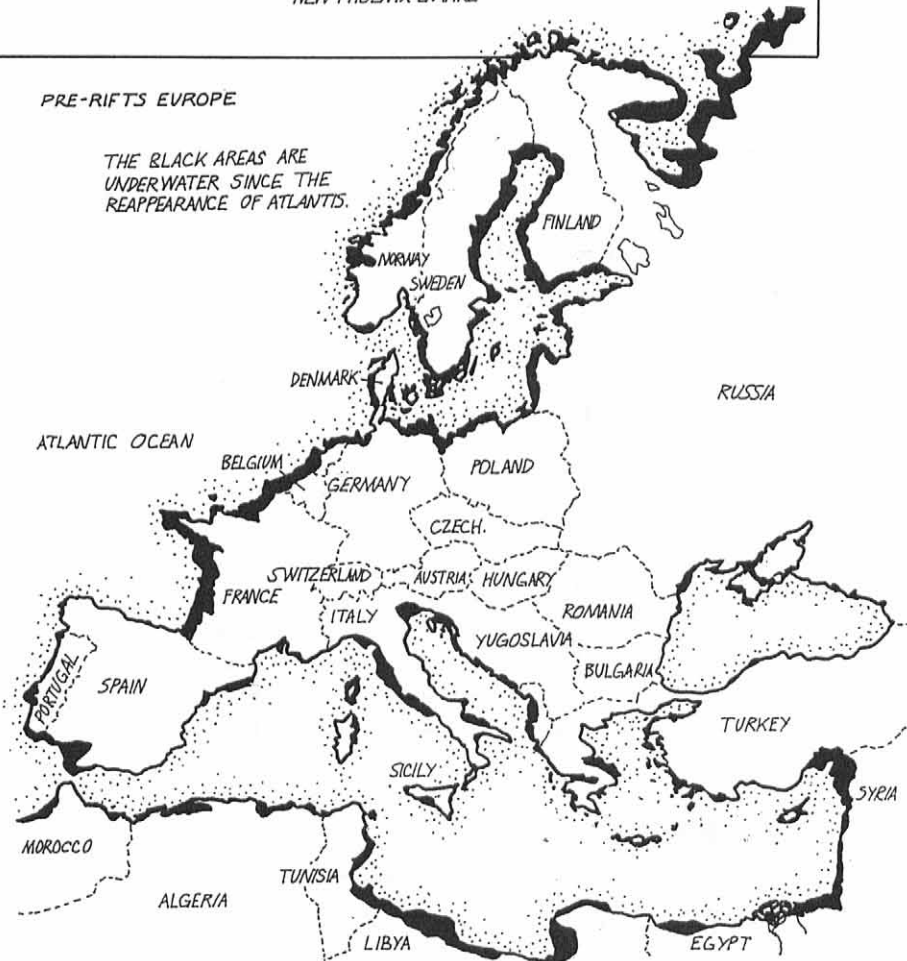

Experience Tables

Intelligence Officer

1	0,000-2,100
2	2,101-4,200
3	4,201-8,400
4	8,401-16,800
5	16,801-25,000
6	25,001-35,000
7	35,001-50,000
8	50,001-70,000
9	70,001-95,000
10	95,001-130,000
11	130,001-180,000
12	180,001-234,000
13	234,001-285,000
14	285,001-345,000
15	345,001-410,000

Intelligence Commando

1	0,000-2,150
2	2,151-4,300
3	4,301-8,600
4	8,601-17,200
5	17,201-25,500
6	25,501-36,000
7	36,001-52,000
8	52,001-73,000
9	73,001-98,000
10	98,001-134,000
11	134,001-184,000
12	184,001-240,000
13	240,001-295,000
14	295,001-365,000
15	365,001-425,000

Power Armor Commando

1	0,000-2,200
2	2,201-4,400
3	4,401-8,800
4	8,801-17,600
5	17,601-27,800
6	27,801-37,900
7	37,901-55,100
8	55,101-75,200
9	75,201-100,300
10	100,301-145,500
11	145,501-190,600
12	190,601-245,700
13	245,701-295,800
14	295,801-345,900
15	345,901-415,100

Robot Soldier

1	0,000-2,500
2	2,501-5,000
3	5,001-10,000
4	10,001-20,000
5	20,001-30,000
6	30,001-50,000
7	50,001-80,000
8	80,001-120,000
9	120,001-160,000
10	160,001-190,000
11	190,001-240,000
12	240,001-300,000
13	300,001-370,000
14	370,001-440,000
15	440,001-510,000

Cyborg Soldier

1	0,000-2,150
2	2,151-4,300
3	4,301-8,600
4	8,601-18,600
5	18,601-26,600
6	26,601-36,600
7	36,601-54,600
8	54,601-75,600
9	75,601-99,600
10	99,601-135,600
11	135,601-185,600
12	185,601-240,600
13	240,601-290,600
14	290,601-343,600
15	343,601-423,600

Robot Combat Pilot

1	0,000-2,250
2	2,251-4,400
3	4,401-8,800
4	8,801-17,600
5	17,601-24,000
6	24,001-35,000
7	35,001-50,500
8	50,501-72,500
9	72,501-98,500
10	98,501-140,500
11	140,501-200,500
12	200,501-250,500
13	250,501-300,500
14	300,501-400,500
15	400,501-500,000

Gypsy — The Gifted

1	0,000-2,050
2	2,051-4,100
3	4,101-8,250
4	8,251-16,500
5	16,501-24,600
6	24,601-34,700
7	34,701-49,800
8	49,801-69,900
9	69,901-95,000
10	95,001-130,000
11	130,001-180,200
12	180,201-230,000
13	230,001-280,400
14	280,401-340,500
15	340,501-400,600

Gypsy Seer

1	0,000-2,200
2	2,201-4,400
3	4,401-9,000
4	9,001-19,000
5	19,001-28,000
6	28,001-40,000
7	40,001-60,000
8	60,001-80,000
9	80,001-100,000
10	100,001-150,000
11	150,001-200,000
12	200,001-275,000
13	275,001-350,000
14	350,001-425,000
15	425,001-525,000

Gypsy Wizard Thief

1	0,000-2,700
2	2,701-5,400
3	5,401-10,800
4	10,801-21,600
5	21,601-31,600
6	31,601-42,800
7	42,801-62,000
8	62,001-90,000
9	90,001-120,000
10	120,001-170,000
11	170,001-220,000
12	220,001-290,000
13	290,001-400,000
14	400,001-500,000
15	500,001-700,000

Gypsy Thief

1	0,000-1,900
2	1,901-3,800
3	3,801-7,300
4	7,301-14,300
5	14,301-21,000
6	21,001-30,000
7	30,001-40,000
8	40,001-53,000
9	53,001-73,000
10	73,001-103,000
11	103,001-138,000
12	138,001-188,000
13	188,001-238,000
14	238,001-288,000
15	288,001-330,000

Euro-Juicer

1	0,000-2,140
2	2,141-4,280
3	4,281-8,560
4	8,561-17,520
5	17,521-25,520
6	25,521-35,520
7	35,521-50,520
8	50,521-71,000
9	71,001-96,000
10	96,001-131,200
11	131,201-181,300
12	181,301-231,400
13	231,401-281,500
14	281,501-341,600
15	341,601-401,700

Communications Officer

Medic/Medical Officer

Field Mechanic O.C.C.

1	0,000-1,925
2	1,926-3,850
3	3,851-7,450
4	7,451-15,000
5	15,001-21,500
6	21,501-31,500
7	31,501-41,500
8	41,501-54,000
9	54,001-75,000
10	75,001-105,000
11	105,001-140,000
12	140,001-190,000
13	190,001-240,000
14	240,001-300,000
15	300,001-350,000

Combat Soldier & Police/Enforcement

1	0,000-1,970
2	1,971-3,940
3	3,941-7,880
4	7,881-14,880
5	14,881-21,880
6	21,881-31,880
7	31,881-41,220
8	41,221-54,440
9	54,441-74,660
10	74,661-104,880
11	104,881-139,220
12	139,221-189,440
13	189,441-239,660
14	239,661-290,880
15	290,881-335,000

Other O.C.C.s & R.C.C.s

Characters from the **Rifts RPG** and **Rifts Worldbooks** like the True Atlantean, druid, temporal raider, knight, crazy, line walker, techno-wizard, wilderness scout, mind melter, dragon

and others can all be used in the European setting. See the appropriate **Rifts RPG books** for the experience tables and additional data about these characters.

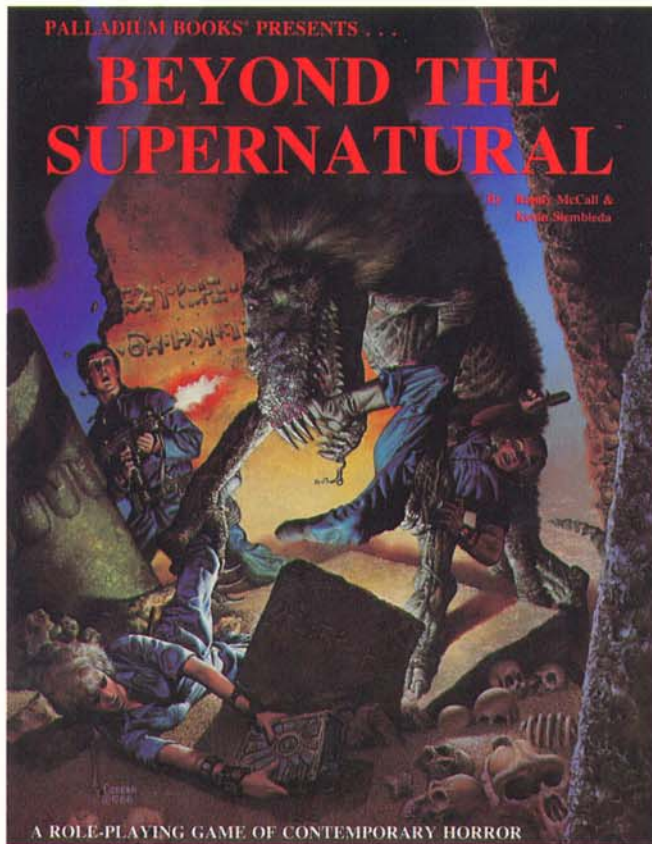

Also from Palladium Books®

Beyond The Supernatural RPG™

Before the ley lines erupted there was the mysterious world of Victor Lazlo's modern Earth — but not as you know it. In the shadows, along the ley lines, among ancient ruins, and the alleys of the cities lurk supernatural predators, ghosts and demons. Scientists deny their existence but from the shadows the monsters laugh.

- Perhaps the most comprehensive horror RPG on the market.
- 9 Occupational Character Classes, including several psychic O.C.C.s, the arcanist, and parapsychologist.
- Over 40 psychic abilities.
- A magic system that works in the modern world.
- Monsters, ghostly entities, supernatural possession and more!
- A unique world that blends horror, the paranormal, and technology set in our modern world.
- Reviewer and designer, Ken Rolston, reported the concepts in this book border on "genius." See why!
- Written by Kevin Siembieda & Randy McCall.
- Art by Steve Bisette, Long and Siembieda. Cover by Corben.
- 250+ pages — \$19.95

Palladium Books® Presents:

Rifts® World Book Five: Triax™ & The NGR™

- Comic Strips by Kevin Long and Kevin Siembieda.
- 20 new O.C.C.s. and new skills.
- New robots, power armor, cyborgs, implants, weapons, tanks, aircraft and equipment by the ton!
- The New German Republic outlined and mapped.
- The Gargoyle Empire and other villains.
- Epic adventure, ideas and more!
- Over 200 pages.

A supplement for the Rifts® RPG.

Compatible with the entire Palladium Books® Megaverse®!

\$20.95

Cat. No. 810

I.S.B.N. 0916211-60-6

ISBN 0-916211-60-6

