

Palladium Books® Presents:

Rifts® Dimension Book Two: Phase World™

By C.J. Carella

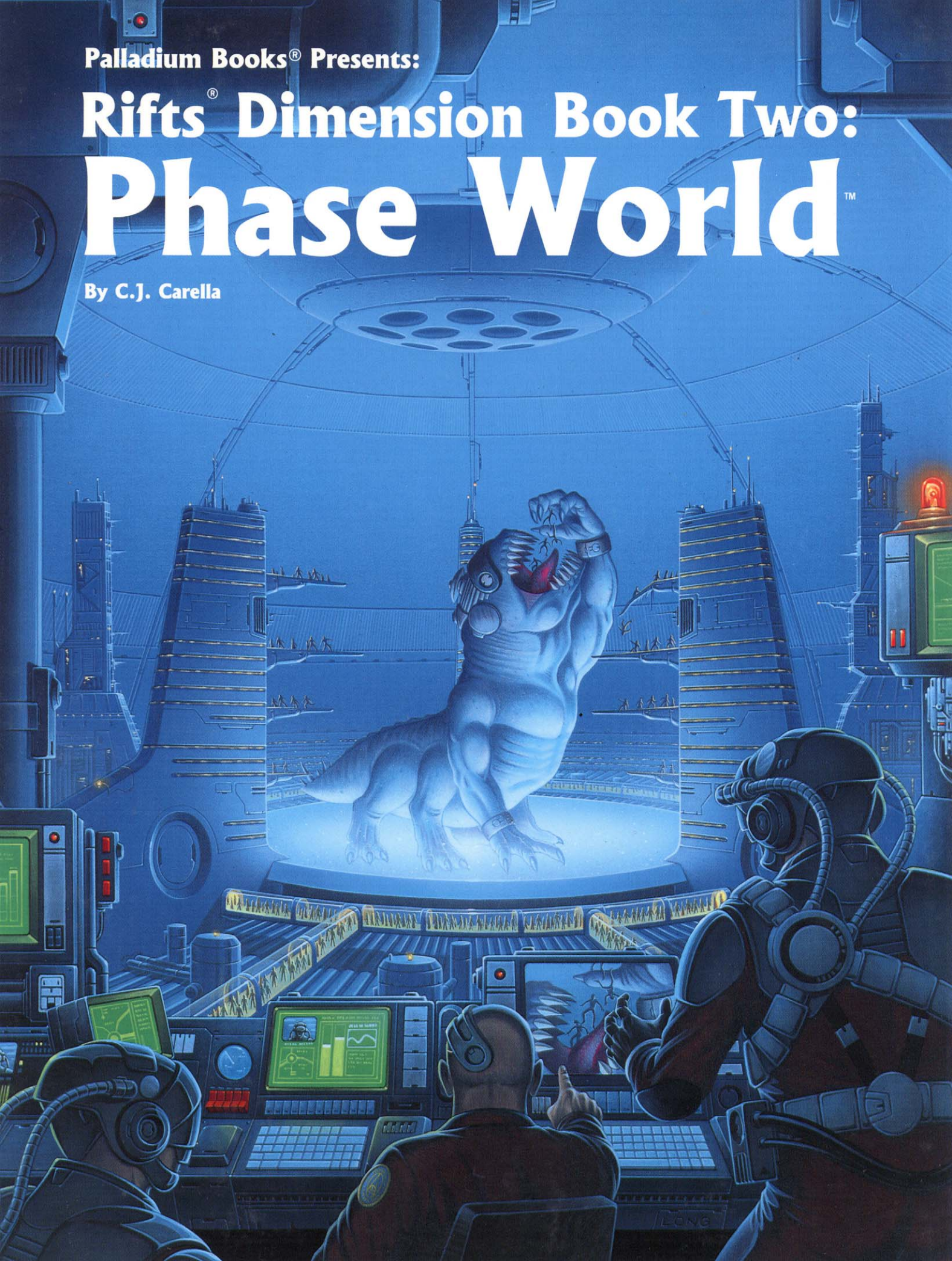

Warning!

Violence and the Supernatural

This book may be inappropriate for young readers.

The fictional World of Rifts[®] is violent, deadly and filled with supernatural monsters. Other-dimensional beings, often referred to as “demons,” torment, stalk and prey on humans. Other alien life forms, monsters, gods and demigods, as well as magic, insanity, and war are all elements in this book.

Some parents may find the violence and supernatural elements of the game inappropriate for young readers/players. We suggest parental discretion.

Please note that none of us at Palladium Books[®] condone nor encourage the occult, the practice of magic, the use of drugs, or violence.

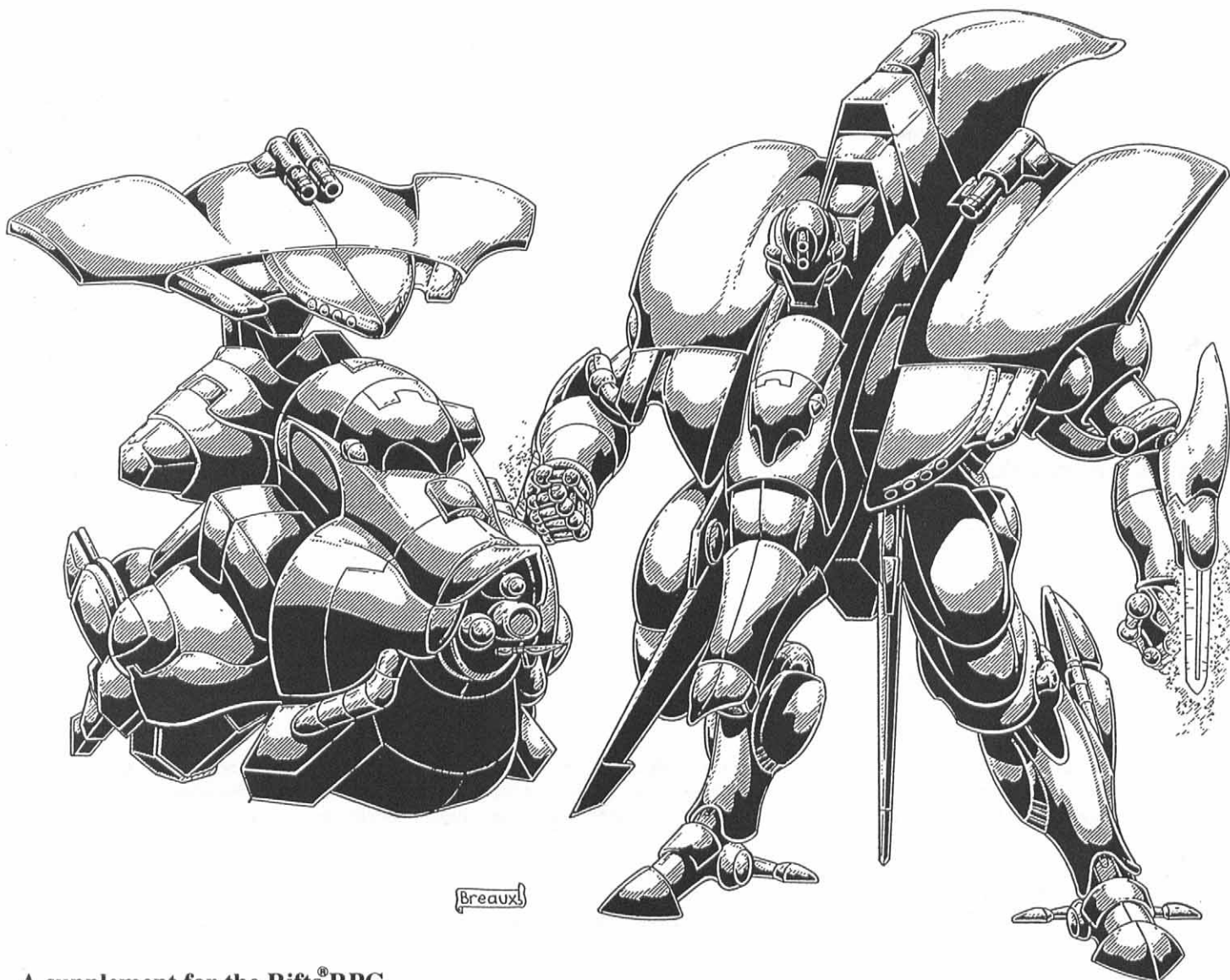

A supplement for the Rifts[®] RPG.
Compatible with the entire Palladium Books Megaverse![®]

Palladium Books® Presents:

Phase World™

Rifts® Dimension Book Two:

Written By: Carlos J. Martijena-Carella

Additional Text & Concepts: Kevin Siembieda

Senior Editor: Kevin Siembieda

**Editors: Alex Marciniszyn
James A. Osten
Kevin Kirsten
Julius Rosenstein**

Cover Painting: Kevin Long

**Interior Artists: Wayne Breaux Jr.
Scott Johnson
Kevin Long
Vince Martin**

**Character Sheets: Thomas Bartold
Kevin Kirsten**
(Inspired by designs by Gordon Delp)

Art Direction & Keylining: Kevin Siembieda

**Typography: Maryann Siembieda
Michael O'Connor**

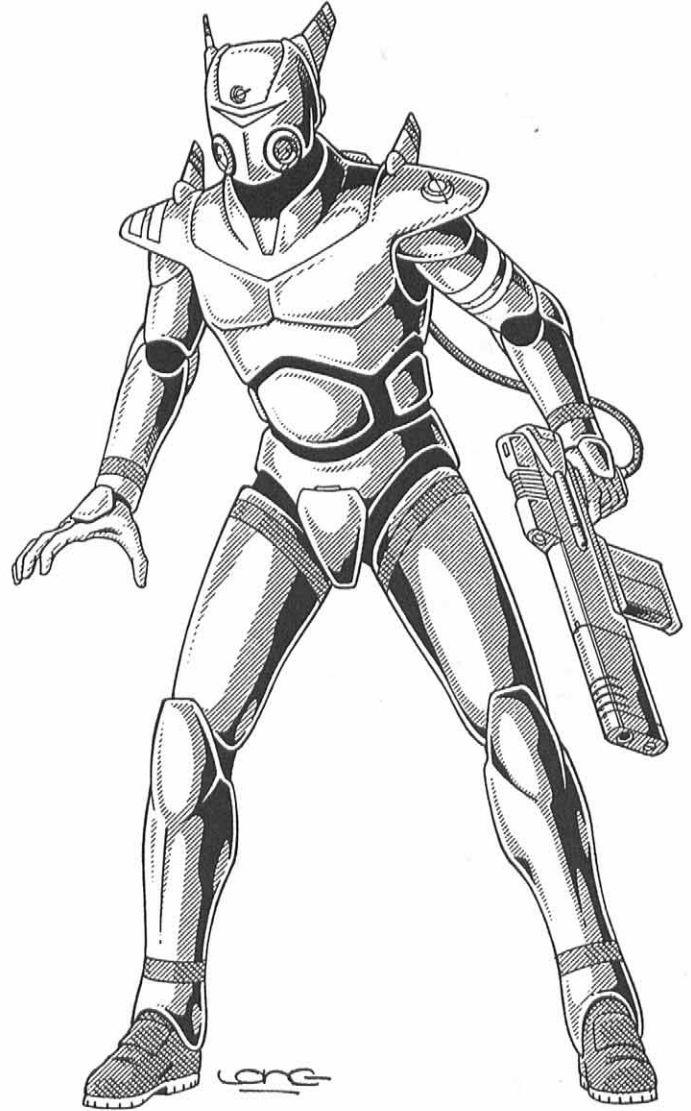

Special Thanks to C.J. Carella for an epic, new dimension of adventure and mystery. To Kevin Long for his cover depicting an unwanted visitor from a Rift. Vince and Wayne for some of their best artwork ever! Talented new artist Scott Johnson for his contributions. And to Maryann, Kevin Kirsten, Steve, Alex, Mike and the usual gang of Palladium wizards for another exciting Rifts dimension book.

Kevin Siembieda

Contents

Introduction	7	True Naruni R.C.C. (NPC Villain)	48
The Phase World Universe	8	The Gene Splicers	49
The Cosmic Forge	9	The Three Galaxies	50
An Overview of Phase World	9	Languages (Trade Tongues 1-6)	52
The Spacegates	10	The Consortium of Civilized Worlds (CCW)	53
Phase World Government	10	CCW Government	53
Society	11	CCW Society	55
Foreign Relations	11	Foreign Affairs	55
Center	11	Major Worlds of the CCW	55
City Highlights	14	CCW Characters & O.C.C.s	56
Level 1: The Manors	14	CAF Trooper O.C.C.	56
Level 2-A: Gateland	15	CAF Fleet Officer O.C.C.	58
Level 2-B: Space Port	17	TVIA Inspector O.C.C.	59
Level 3-A: Splugorth Trading Post	17	CAF Scientist O.C.C.	60
Level 3-B: The Open Market/Wonderworld	18	Noro R.C.C.	61
Level 4-A: Free Trade Zone (Naruni Enterprises)	18	Noro Psychic O.C.C.	63
Level 4-B: The Warlock Market	19	Noro Mystic Warrior O.C.C.	64
The Lower Levels: 5-8	19	Space Wolfen R.C.C.	65
The Rift Levels: 9-10	20	Wolfen Quatoria O.C.C.	66
Some Notable Citizens	20	Catyr R.C.C.	68
Thraxus	20	Seljuk R.C.C.	69
Anshurr	22	The Transgalactic Empire (TE)	70
Trader Smythers	23	Government	71
The Knife Master	23	Society	72
The Promethean R.C.C.	24	The Free World Council	72
The First Stage Promethean	25	Foreign Affairs	73
Promethean Phase Adept O.C.C.	27	Major Worlds of the Transgalactic Empire	73
Promethean Time Master O.C.C.	28	Kreeghor R.C.C.	73
Phase Mystic O.C.C.	29	Royal Kreeghor R.C.C.	74
Second Stage Promethean	31	Kreeghor Emperor (NPC Villain)	76
Phase Powers	32	Machine People R.C.C.	77
Anti-Phase	32	Silhouette R.C.C.	80
Close Rift	32	Imperial Legionnaire O.C.C.	82
D-Phase	32	Imperial Security Agent O.C.C.	82
D-Shift Distance	32	Freedom Fighter O.C.C.	83
D-Shift Ghost	33	The United Worlds of Warlock (UWW)	84
Dimensional Leap	33	Government	85
Fast Draw	34	Society	86
Multi-Phase	34	Foreign Affairs	86
Phase Blast	34	Major Worlds within the United Worlds of Warlock	86
Phase Field	34	The Splugorth Planets	86
Phase Warp: Confuse	34	Government	87
Phase Warp: Displacement	34	Society	87
Phase Warp: Split Persona	34	The Paradise Federation	87
Spacial Distortion: Self	35	Government	88
Spacial Distortion: Others	35	Society	88
Other Races & O.C.C.s of Note	35	Foreign Affairs	88
Draconoid R.C.C.	35	Pleasurer R.C.C.	88
Phantom R.C.C.	36	Other Worlds & Organizations of Note	90
Spacer O.C.C.	38	The Star Hives	91
Galactic Tracer O.C.C.	39	Killer Beetles (NPC Villain)	91
Space Pirate O.C.C.	40	Vacuum Wasps R.C.C.	92
Runner O.C.C.	41	Termite Engineer R.C.C.	93
Colonist O.C.C.	42	Worker Ants (NPC Villain)	94
Other Rifts O.C.C.s and R.C.C.s	43	Hive Queen (Evil Alien Intelligence)	95
Naruni Enterprises (N.E.)	44	The Dominators	96
The Naruni Repo-Bot R.C.C.	46	The Dominator R.C.C.	96

Contents

The Cosmo-Knights	99	Gravitonic Technology	125
The Cosmo-Knight O.C.C.	100	Gravity Rail Guns	125
The Fallen Knights	102	GR-10P Pistol	125
Creating More Alien Races	104	GR-45HP "Jackhammer" Heavy Pistol	126
Step One: Attributes	104	GR-15AR Assault Rifle	126
Step Two: Damage Capacity	104	Grav Packs	126
Step Three: Alien Appearance	105	Psionic Crystal Technology	127
Step Four: Physiological Modifications	105	Crystal-Bolt Pistol	127
Step Five: Unusual Characteristics	106	Crystal Paralyzer	127
Step Six: Unusual Powers	106	Crystal Assault Rifle	128
Step Seven: Technological Level	107	Augmenting Helmet	128
Step Eight: Magic Level	107	Telepathic Communicator	128
Step Nine: General Attitude/Culture	108	Psionic Crystal Armor	128
Monsters and Animals	109	Psionic Power Armor	128
Arboreal Wailers	109	Robots & Powered Armor	130
Kreeghor Bloodhounds	110	Silverhawk Attack Exoskeleton (CAF)	130
Lesser Ugglies	111	Battleram Attack Robot (CAF)	133
Vampire Ugglies	112	"Groundpounder" PA-10 Infantry Power Armor (CAF)	135
Killer Apes	112	Warlord Mark I (TE)	137
Weapons and Technology	114	Warlord Mark II (TE)	139
Weapons	114	Kittani Transformable Robot-Fighter	140
HI-30 Laser Pistol	114	Other Equipment	142
HI-10 Heavy Laser Pistol	115	Tanks & Infantry Fighting Vehicles	143
HI-50 Laser Rifle	115	"Bombard" Infantry Robot (CAF)	143
HI-80 Combat Laser Rifle	115	Phalanx Main Battle Tank (CAF/Wolfen)	145
EP-5 Energy Pulse Pistol	116	Maniple IFV APC (CAF)	147
EPR-8 Energy Pulse Rifle	116	Dark Slayer Main Battle Tank (TE)	147
Power Halberd	116	Kartuhm-Terek "The Doomsday Machine" (TE)	148
NE-4 Plasma Cartridge Pistol	117	Starships & Space	150
NE-10 Plasma Cartridge Rifle	117	Space Skills (New)	150
NE-200 Plasma Cartridge Machinegun	117	Fighters & Small Vessel Combat	151
NE-50 Particle Beam Rifle	118	FTL Propulsion	152
CAF Repeating Rocket Launcher	118	Sensor Systems	153
Body Armor and Spacesuits	119	SpaceShip Weapon Systems	153
Light Combat Armor	119	Point Defense Lasers	153
CAF Jumpsuit	119	HI-Laser Cannon (Light)	154
CAF Battle Armor	120	HI-Laser Cannon (Medium)	154
CAF Heavy Battle Armor	120	HI-Cannon (Heavy)	154
Spacer Suit	120	Particle Beam Cannon (Light and Medium)	154
Spacer Hard Suit	120	Particle beam Cannon (Heavy)	154
Kreeghor Battle Armor	121	PC-50 Light Phase Cannon	155
Imperial Legionnaire's Armor	121	PC-100 Phase Cannon	155
Personal Force Fields	121	PC-200 heavy Phase Cannon	155
N-F12A Light Force Field	121	GR-100 Light Autocannon	155
N-20 (A or B) Medium Force Field	121	GR-1000 Autocannon	155
N-40 Heavy Force Field	122	Missiles	155
N-50 Superheavy Force Field	122	Rift Projector Cannon (UWW)	155
Phase Technology	122	Variable Force Fields	156
Phase Beamers	122	Space Fighters	157
PH-21 Phase Beamer	123	Scorpion Class Light Fighter (CAF)	157
PH-100 Heavy Phase Beamer	123	Proctor-Class Long Range Interceptor (CAF)	158
PH-400 Heavy Phase Beamer	123	Flying Fang Interceptor (TE)	159
Phase Sword	124	Broadsword Delta-Wing Multi-Environmental Fighter (NE)	160
Phase Fields	124	Star Ghost-Class Fighter (Phase World)	162
P-Field (Defensive Fields)	124	Shadow Bolt Strike Ship (UWW)	164
OP-Fields (Out of Phase Fields)	124	Military Shuttles	165
Phase-Tech Med Kit	125	CAF Assault Shuttle	165

Contents

“Rain of Death” Troop Transports (TE)	166	Typical Runner Ship	171
Star Freighters	168	Typical Merchantman	172
Scimitar-Class Light Patrol Ship (CAF)	168	Starships	173
Berserker Class Warship (TE)	170	Phase World Campaign Ideas	173
Merchant and Transport Ships	171	Character Sheets	181

Quick Find

CCW: Consortium of Civilized Worlds	53
CCW Body Armor	119
CCW Weapons	15
CCW Robots & Power Armor	130
CCW Rocket Launcher	118
Chronicles of the Cosmos	9
Cosmic Forge: Origin	9
Experience Tables	183
First, The: Origin/History	9
FTL Propulsion	152
Gravitonic Technology & Weapons	125
Grav Packs	126
Kittani Robot Fighter	140
Languages	52
Monsters and Animals	109
Paradise Federation	87
Psionic Crystal Technology & Weapons	127
Monsters and Animals	109
Skills (new)	150
Spaceship Weapons	153
Spaceship: Fighters	157
Spaceship: Merchant	171
Spaceship: Military Shuttles	165
Star Hives	91
Tanks and Vehicles	143
United World of Warlock (UWW)	84

Naruni Enterprises	44
NE: Board of Directors	44
NE: Center (lvl 4-A)	18
NE: Force Fields	121
NE: Repo-Bots R.C.C.	46
NE: Thraxus NPC	20
NE: Trader Smythers NPC	23
NE: True Naruni R.C.C.	48
NE: Weapons	117

Phase World

Phase World: Center	11
Phase World: City Highlights	14
Phase World: Dimensional Gateways	13
Phase World: Gateland (lvl 2-A)	15
Phase World: Overview	9
Phase World: Prometheans	24
Phase World: Spacegates	10
Phase World: Spacegate Jump System	153
Phase Mystic O.C.C.	29
Phase Powers	32
Phase Technology & Weapons	122
Promethean R.C.C.	24
Promethean First Stage R.C.C.	25
Promethean Phase Adept O.C.C.	27
Promethean Second Stage NPC	31
Promethean Time Maste O.C.C.	28

Splugorth: Center (lvl 3-A)	17
Splugorth: Anshurr NPC	22
Splugorth Planets	86
TE: Transgalactic Empire	70
TE: Body Armor	121
TE: Doomsday Machine	148
TE: Kreeghor Emperor	76
TE: Weapons	116

O.C.C.s & R.C.C.s

CAF Fleet Officer O.C.C. (CCW)	58
CAF Scientist O.C.C. (CCW)	60
CAF Trooper O.C.C. (CCW)	56
CAF TVIA Inspector O.C.C. (CCW)	59
Catyr R.C.C. (CCW)	68
Colonist O.C.C.	42
Cosmo-Knight O.C.C. (optional)	100
Cosmo-Knight: Fallen O.C.C.	102
Creating Alien R.C.C.s	104
Dominator R.C.C.	96
Draconid R.C.C.	35
Freedom Fighter O.C.C. (TE)	83
Galactic Tracer O.C.C. (Bounty Hunter)	39
Imperial Legionaire O.C.C. (TE)	82
Imperial Security Agent O.C.C. (TE)	82
Kreeghor R.C.C. (TE)	73
Kreeghor, Royal R.C.C. (TE)	74
Machine People R.C.C. (TE)	77
Noro R.C.C. (CCW)	61
Noro Mystic Warrior O.C.C. (CCW)	64
Noro Psychic R.C.C. (CCW)	63
Other O.C.C.s & R.C.C.s	43
Phantom R.C.C.	36
Phase Mystic O.C.C.	29
Pleasurer R.C.C.	88
Promethean R.C.C.	24
Promethean First Stage R.C.C.	25
Promethean Phase Adept O.C.C.	27
Promethean Second Stage NPC	31
Promethean Time Master O.C.C.	28
Runner O.C.C.	41
Repo-Bots R.C.C.	46
Seljuk R.C.C. (CCW)	69
Silhouette R.C.C. (TE)	80
Spacer O.C.C.	38
Space Pirate O.C.C.	40
Space Wolfen R.C.C. (CCW)	65
Termite Engineer R.C.C. (optional)	93
True Naruni R.C.C.	48
Vaccum Wasp R.C.C. (optional)	92
Wolfen Quatoria O.C.C. (CCW)	66

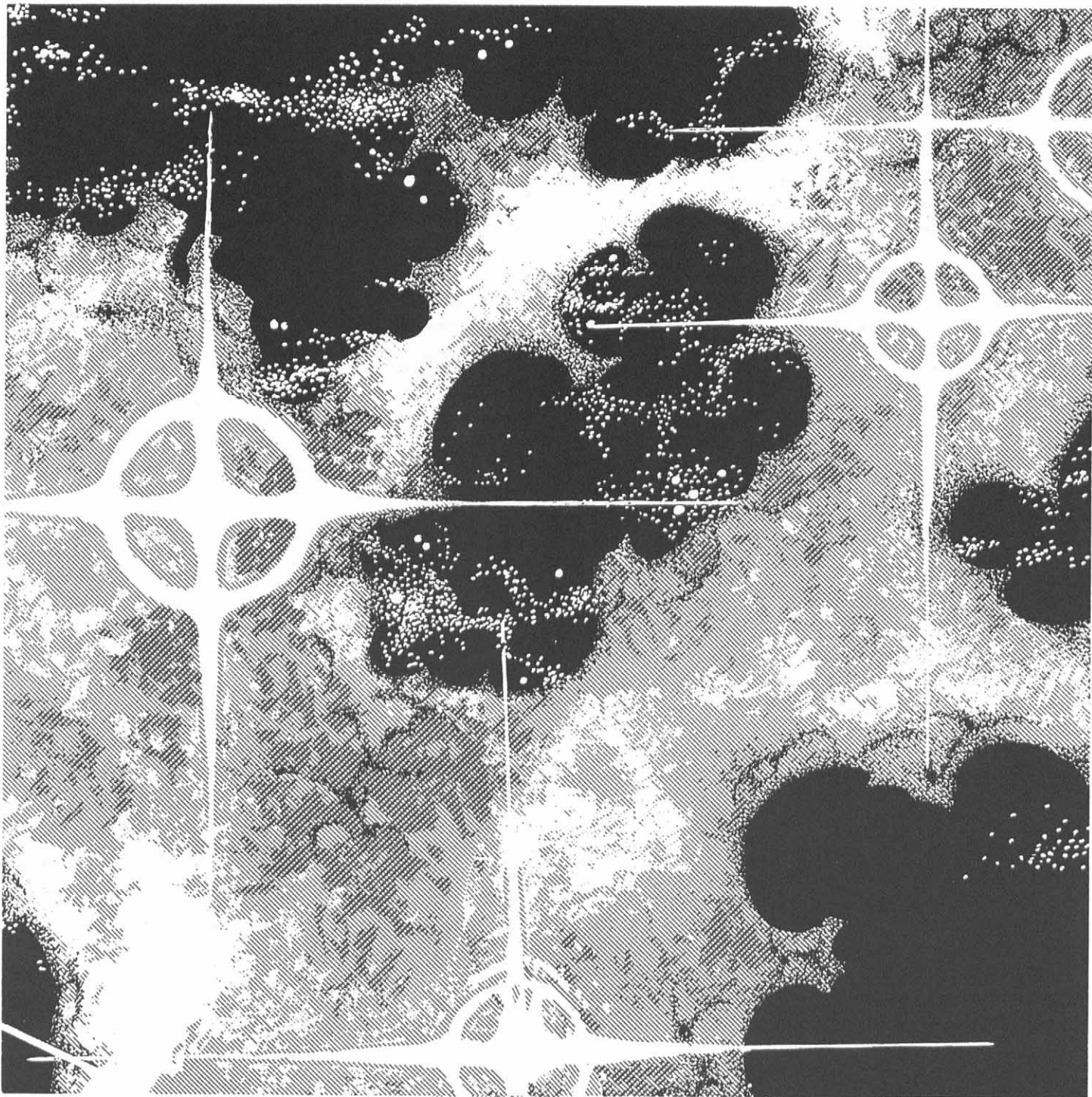

Introduction

Space adventure has always held a special place in my feverish mind. Among the endless stars, anything is possible, from exploration and discovery to cosmic adventures and mundane dramas. All the traditional tales, and a few unique ones, can be told against a backdrop of alien worlds and exotic races. While writing **Phase World**, I tried to keep all those possibilities in mind. The world in these pages tries to encompass several themes of science fiction and fantasy while keeping the unique flavor of the **Rifts** setting.

In these pages you will find old villains like the Splugorth and Naruni Enterprises alongside new ones, like the predatory Kreeghor and the alien Star Hives. Phase World's Center can be

the ultimate campaign city, a place where everything and everyone can pop up to give aid or cause trouble. The neighboring Three Galaxies are big enough to accommodate wars and crime-infested worlds as well as decadent luxury planets and anything in between. As it often happens with a **Rifts** book, the number of ideas soon outstripped deadlines and page counts, so I will continue to detail the Phase World universe in future sourcebooks. In fact, I am currently working on the first Phase World Sourcebook which should hit the shelves a few months after this one does.

So holster your laser pistol, hop into your phase ship, and visit the Three Galaxies. Hope you enjoy the trip.

The Phase WorldTM Universe

"I sure hope you know what you're doing, Slick," Cray whispered. "Collecting a bounty on Level Nine is always a royal pain. I still think we should wait until he ..."

"No waiting," Slick said, his voice cold and steady. "We can't let him escape."

Cray shrugged. Teaches him to partner up with a total stranger. Still, if Cray hadn't joined forces with Slick, he'd still be trying to find Duke in the Red Nebula, half a galaxy away. Slick's info and Cray's contacts had led them to *Phase World*.

Figures, Cray thought philosophically. Everything comes to Phase World, eventually. The fact that he had been born on the damned mudball didn't make him feel any better about collecting a bounty there. Phase World was weird. Weird in a way that made Cray, a guy who had been to seventy-two different planets and thought he'd seen it all, feel the hackles on his neck rise even before their starship had docked.

Well, too late to back down now, Cray thought as he and his partner entered the bar. At least this time he was working with another human. Nothing wrong about aliens, not really, but he never could trust them completely.

The bar was chock-full of aliens. This was level Seven, after all, just an elevator's ride away from the space docks and too close for comfort to the *D-Gates*. Cray almost shuddered at the thought of them. Nobody could pay him enough to track somebody to another dimension. It was bad enough going to other planets.

Cray scanned the bar with trained eyes. On the corner table to his left, sat two humans, a kreeghor Renegade and a green humanoid with six eyes arranged around his head. They were playing a game of las-chips. From the way the kreeghor's ridge spines kept rising and falling, he was not doing too well, and an unhappy kreeghor was bad for anybody's health. The hologram over the bar depicted three female singers going on about freeing one's mind, in some language close enough to *Galactic Trade Tongue Four* that he could make it out. A winged faerie of some kind frittered around the image.

Then he saw Duke. He was walking towards the las-chip game, probably to spend some of the money he'd made traffick-ing forbidden *Forge* artifacts. Out of the corner of his eye, Slick nodded. Let's be smooth, Cray prayed. The HI-laser pistol was in his hand and leveled at Duke in the space of a heartbeat.

"Bonded Authority!" Cray yelled out loud. "Freeze, Duke! We've got you covered!"

Duke froze. He looked humanoid enough, except for the grayish skin and lack of any body hair. Standing still, he made a good impression of a statue. So far so good. Now ...

Duke twisted his head so he was facing Cray. "Don't move," Cray repeated. What the hell was Slick doing? He hadn't even drawn a gun!

At least the rest of the bar's customers were not interfering.

Duke smiled. His yellow eyes flashed with a blast of light, and next thing Cray knew, he was on the floor, convulsing in pure agony. Magic! his mind yelled above the blinding pain. Bastard's got magic!

Cray hated magic.

Duke turned to Slick. His eyes flashed again, and Cray expected to see his partner fall down and convulse. Instead, Slick just stood there, cool as a cucumber.

"Duke Stone-Fist," Slick said calmly. "You are guilty of violating the sanctity of the Cosmic Forge. What you stole has caused the deaths of two billion sentient beings. You will pay for your crimes."

"You may be magic-proof, sucker, but I bet you ain't laser proof!" Duke drew and fired as he spoke. Cray, who had managed to crawl to his feet, saw Duke's face sag with incredulity. His expression mirrored Cray's. The high-intensity laser beam had struck Slick right above his left eye. But his head hadn't been vaporized as it should have. In fact, Slick's skin wasn't even singed!

"Wrong move." Slick's body flashed red. After the blinding light was gone, Cray's old partner had been replaced by a metal-armored figure. The armor looked more like a second skin, following every muscle curve in Slick's body. The helmet had a razor-sharp crest, and Slick's face was sculpted on the outside. No, it wasn't sculpted, because the metal lips moved when Slick spoke.

"You will pay, Duke."

A Cosmo-knight. Just great, Cray thought. Any chances he'd had of collecting the bounty had just gone out the window. Cosmo-knights rarely took prisoners, and what remains they left behind were never enough for concrete identification. A Cosmo-knight could bring down the whole bar if Duke didn't surrender, and since Duke was pulling an archaic-looking sword that crackled with mystic energy, it didn't look like Duke was going to surrender.

This was shaping up to be a real bad day.

Phase World is a planet in the *Three Galaxies*, one of millions of inhabited worlds. Neither the planet nor the Three Galaxies are what most people would consider normal. The Phase World universe is a place where magic, technology and super powers coexist and create volatile mixtures. Where ultra-powerful cosmo-knights soar unaided through space, and where ultra-tech spaceships exchange broadsides with enchanted vessels. There are two major elements in this universe, elements that influence every planet whose natives have managed to break free from the bonds of gravity and space-time. The first one is the **Cosmic Forge**, a mythical artifact that is believed to be responsible for the coming of magic and super-powers. The other is **Phase World** itself, the commercial and technological center of the universe, the terminus of all known spacelanes — and a world where transdimensional gates reach to hundreds of other universes.

The planet Phase World is a transdimensional nexus point rivaled only by Rifts Earth. Dimensional travelers from all points in the Megaverse, from Splugorth agents to mages from the Palladium world to the denizens of Wormwood and many other

places, they all come together in this strange planet where normal space and time is an illusion.

Everything comes together in *Center*, a mountain-like city that holds 600 million people! People that represent thousands of races and incredible origins. Center is the largest spaceport and dimensional terminus of the Three Galaxies, a mile-high arcology where the worst slums of the Megaverse coexist with unimaginable wealth. The native race of Phase World, the mysterious *prometheans*, are the masters of phase technology, a form of science that allows incredible feats such as teleportation, faster-than-light travel and powerful force fields.

The Cosmic Forge

“When the universe was young, The First rose from the primeval ooze. The First made machines and built a civilization while today’s stars were still being born. Being The First, they were the wisest and most learned of all. They broke the chains of gravity and the bonds of *realspace*. On golden chariots they explored the nascent galaxy. In their laboratories, they learned to breed stars.

“They wanted too much, the First did. A thousand worlds conquered, stars enclosed in crystal spheres, gateways to infinite realities, they had all this and more. The First thirsted for the innermost secrets of the universe and they searched for them with all their energy. On the farthest corner of reality, where *realspace* and *otherspace* meet, they built a Forge. A cauldron where a million galaxies could be born. The Cosmic Forge was no mere tool, for no mindless artifact could contain its power. The minds and souls of a thousand thousands of the wisest among the First were placed within the Cosmic Forge. When its fire burned, it could be seen instantly across the entire galaxy, unbound by distance and time. And The First rejoiced, for they thought they had mastered the arts of creation.

“The Cosmic Forge tried to use Its powers to help. Its energies coursed through the stars, healing the sick, empowering the genes of The First, giving Its creators the gift of eternal life. The First became as gods and basked in the light of the Forge.

“But every light casts a shadow. There was One among the First who seethed with jealousy and anger. The One wished to be above the First, as the First were above all others. The One coveted the power of the Cosmic Forge. Its guardians were deceived and overpowered. The One seized the Forge for just a moment. With but a wish, he willed The First to be no more. A thousand worlds were cleansed of life in that instant, and the First were no more. The Cosmic Forge spewed forth flames that to this day swirl across the galaxies, sometimes touching the living and gifting or slaying them.

“The One’s triumph lasted but a moment, for the Forge was self-aware and not an obedient slave. It broke free and sent the One into oblivion. But then, in horror, It saw what It had done, and hid Its Light in shame. And through an eternity, the Cosmic Forge remains hidden, touching only those few who are worthy of Its power.”

—From the *Chronicles of the Cosmos*

The legends of every spacefaring civilization in the Phase World universe mention the Cosmic Forge. Obscure manuscripts like the *Chronicles of the Cosmos* offer precious few facts. It is widely believed that the First were an ancient civilization that created some ultimately powerful artifact. Some think it was an artificially created space anomaly, something like the natural forming of black holes, only a thousand times more potent. Others have speculated that it was a planet-sized computer with infinite wisdom and knowledge. Some suspect it was all those things and more, perhaps a “reality generator” where the wishes of the user would be granted and become reality! A few civilizations with a mystical outlook accept the words of the *Chronicles* literally. Sometimes, these disagreements flare into the galactic equivalent of religious wars.

The Cosmic Forge is used to explain anything that defies scientific and sorcerous explanations. Among other things, the influence of the Forge accounts for the existence of powerful “magic fields” and a system of ley lines that extends into space and crisscross the Three Galaxies. Magic is as powerful in the Three Galaxies as it is on Rifts Earth and Wormwood. Most civilizations, however, are ignorant of this fact, and have little or no skills in the use of magic, preferring to rely on technology and psionic powers.

An Overview of Phase World™

Phase World: The Planet

Population Breakdown: 5 billion (estimated)

Prometheans 71%

Draconids 10%

Phantoms 4%

Center citizens and visitors 15%

Phase World is the foremost trading point of the Three Galaxies, and perhaps of the Megaverse. Connected to hundreds of dimensions and accessible to thousands of planets on its own dimension, this world is often referred to as the “Center of the Universe.” While this is an exaggeration, everybody who has visited the planet agrees that very few places in the Megaverse share the diversity and strangeness of this world.

Located near the core of the oldest known galaxy, Phase World is the fifth planet of an aging red star. From up in orbit, it has a red-and-blue coloration; most of the land is made up of reddish minerals, and the planet has less free water than Earth. The planet is close to Earth in size and has a day that lasts 22.3 terrestrial hours. Phase World’s orbit around its star is much longer, however, so a Phase World year is roughly equivalent to fifty-three Earth years. The climate is artificially uniform, with temperatures averaging 70-80 degrees Fahrenheit (21 to 27 degrees C), even at the planet’s poles. Exactly how this is accomplished is one of Phase World’s many secrets. Only its rulers know if this control over weather is achieved through magic or technology.

The landscape is dotted by farms and cities. However, visitors rarely get to see how the majority of Phase World's inhabitants live, because they are confined to **Center**, an enormous enclosed city or arcology. Center is an artificial mountain that stands one mile high. It is made up of hundreds of levels that go all the way down beneath the surface to a mile in depth. Six hundred million sentients inhabit Center, making it one of the largest cities in the Three Galaxies. Inside, there are the equivalent of a dozen full cities, each on top of the other. Throughout the recorded history of the Three Galaxies, Center stands as one of the wonders of the universe, an unmatched feat of engineering.

Ships in orbit around phase world can see an intricate network of ley lines crisscrossing the planet. Center itself has no less than a twelve ley line nexus in diverse levels of the city! Ley line storms occur occasionally on the planet's surface, but somehow they are always controlled without damaging people or property.

Surrounding the planet is a ring of sixteen large space stations where large ships and cargo vessels dock. Also within orbit are hundreds of smaller satellites, including military stations and sixty-four *spacegates*. The spacegates are unique devices that bend time and space to allow instant transportation anywhere in the Three Galaxies to Phase World. It is important to understand that the spacegates are a one-way trip to Phase World; they cannot be used to return home (although some of the Rifts gates at Center can be used for such purposes, but most cannot accommodate spaceships). Every hour, hundreds of ships arrive through the spacegates. Meanwhile, hundreds of others arrive and depart using more conventional methods of travel. Not everybody trusts the spacegates, although there has never been any problems with them.

Everything from small shuttle-sized vessels to giant cargo ships are allowed to land at Center's huge spaceport on the planet's surface. However, much of the trade takes place in orbit, with ships exchanging cargoes and passengers with other ships and orbital stations. Consequently, one never has to land on the planet itself. However, most travelers cannot resist visiting the planet itself. For one, the choicest merchandise, especially those of extra-dimensional origins, can only be found "groundside" at the city of Center. In fact, it is said that *anything* can be found at Center, be it rare pieces of equipment, weapons, magic souvenirs or exotic entertainment. There is danger, especially in the lower levels where maintenance and law-enforcement are scarce, and where Rift activity is a constant threat, but many risk themselves in those areas, because forbidden pleasures and equipment can be purchased there.

Visitors to Phase World include merchants buying and selling wares from places in the Three Galaxies as well as more distant worlds and other dimensions; criminals trying to hide among Center's teeming multitudes; bounty hunters trying to root out those criminals; mercenaries, assassins and other "professionals" selling their talents to the highest bidder; smugglers trying to buy or sell illegal cargoes from all corners of the Megaverse; entertainers looking for work; scientists looking for new technologies to study; magicians searching for unique artifacts; dimensional travelers on their way to other destinations; and thrill-seekers, adventurers and refugees, each of them driven by personal reasons.

Despite its incredible strategic importance, Phase World has remained an independent world throughout its history. Every would-be conqueror who has tried to take the planet has failed, usually losing his life in the process. This independence places Phase World above the laws of most civilizations, which makes it a haven for criminals, refugees, and unsavory characters of all kind. Visitors go there at their own risk.

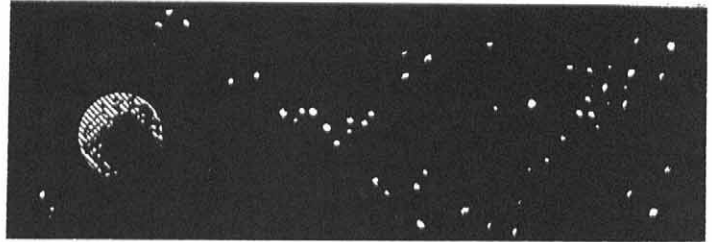

The Spacegates

Sixty-four large structures known as spacegates float in high orbit over Phase World. They are giant rings, 10 miles (16 km) in diameter, covered with strange machinery and monitoring stations. These unique artifacts are powered by legendary *phase technology*. Many people covet the secret of the spacegates, but nobody has been able to examine one closely, let alone get their hands on one of them. Many teams of spies, thieves and scientists have tried to unlock their secrets but none have succeeded. No other civilization in the Megaverse has been able to replicate their effects.

A ship with a *phase transceiver* can instantly teleport to a spacegate from anywhere in the Three Galaxies. The prometheans who man the spacegates can scan the ship (via the phase transceiver) before letting it teleport through. If the ship seems hostile or dangerous, they can refuse to let it make the jump. The gates only work for ships arriving "to" Phase World. The vessel needs to find another way back home, typically using some sort of propulsion system like a gravity drive, phase drive or rift drive. Some merchants don't bother with a spacedrive at all. Instead, they fill a slower-than-light ship with merchandise, teleport to Phase World or to one of the space stations, and sell both the cargo and the ship! They get back home by booking passage back to their world on another ship or through a Rifts gate.

The effect of these spacegates on the economy of the Three Galaxies is enormous. Merchants from the farthest corners of the Three Galaxies can meet and exchange goods on Phase World in a fraction of the time it would take them to go to each other's planets. Coupled with the planet's network of dimensional gates leading to other worlds in the Megaverse, the spacegates make Phase World the place to find anything.

Phase World Government

Phase World is controlled by the **Prometheans**, the only known race to have natural *phase powers*. Besides the prometheans, only the *draconid* and *phantom* races have a significant presence on the planet, and even those have 80% of their population in Center or the orbiting spaceports.

Prometheans have two stages of development: first stage prometheans are the only ones who venture outside their planet. They are large humanoids with rocky hides. Second stage prometheans are much larger, as well as wiser and more power-

ful. "Second-stagers" are also alien beings whose motives and goals are hard (perhaps impossible) to comprehend. The planet is ruled by the Elders, all the second-stage prometheans that remain on the planet. Nobody knows exactly how many "second-stagers" exist, or how they meet or decide policy. Their orders are simply handed down to the administrators of the planet (all of whom are first-stagers) and followed scrupulously.

Diplomacy and all direct contact with other races are also conducted by first-stagers, who then consult with their elders and return with their final judgment. Many races find this insulting, arguing that the prometheans consider other races beneath their notice and send their "children" to talk to them. At least two wars have been fought over this perceived slight. Since the offended races lost the wars both times, the rest have decided to accept this facet of promethean culture, whether it is an insult or not.

Phase World is independent and neutral in matters of galactic policy. The planet does not take sides in any conflict and will trade with all sides of a dispute. Any ship can find safe haven in Phase World space and the planet has no extradition treaties with anybody. Often, vessels from opposite sides in a war may find themselves docked side by side at a port orbiting the planet. Any attempt to launch an attack while in Phase World space (which happens to include most of the solar system from the prometheans' point of view) will result in an attack by the Phase World fleet and the confiscation or destruction of the offending vessel. However, the neutrality policy does *not* apply to the entire city of Center (see that section for details).

Society

As far as any outsiders can tell, Phase World has a very harmonious society, without conflict or disturbances. The first stage prometheans are intelligent and capable beings in their own right, but seem to be perfectly content with obeying their elders on most things. Those who feel rebellious or discontent usually decide to travel beyond the planet, or reside in Center where the influence of their elders is minimal.

When they are allowed to stay, non-prometheans are treated fairly but kept under a watchful eye, and have very limited rights. Most non-prometheans, with the exception of draconids and phantoms, are not allowed to visit or travel to the rest of the world or any spaceports, except under strict supervision. Very few are ever granted residence rights. The draconids and phantoms tend to live in their own communities and select their own local governments; most of them stay at Center and avoid the rest of the planet.

The harmonious nature found on most of the planet clashes badly with the reputation Phase World has throughout the Megaverse as a lawless world where everything is for sale. This reputation is only deserved in the megalopolis known as Center. The decadence and abandon found at Center and on the surrounding space stations (which are little more than extensions of the city itself) are what most people picture when they think of Phase World.

Foreign Relations

Every major civilization in the Three Galaxies uses Phase World as a trading nexus. About 15% to 35% of all trade conducted by the Consortium of Civilized Worlds (CCW), the

Transgalactic Empire, the United Worlds of Warlock (UWW), and most planetary collectives will pass through Phase World. If the planet were blockaded or captured by a hostile force, the economies of all these worlds would suffer a crippling blow. However, at least from a historical point of view, capturing Phase World has proven to be an impossible task. It might be possible to blockade the orbital spaceports, if the blockaders had a massive fleet of ships and were able to defeat Phase World's fearsome Defense Forces, but such a move would not be tolerated by the other "nations" of the Three Galaxies. Such an action would cause them tremendous suffering and incite them to immediately declare war on the blockaders and take action to liberate the port. Also, since reinforcements can be teleported instantly to Phase World through the *Spacegates*, the attackers would have to move very quickly to win a victory. The occasional fool, both mortal and immortal (godlings), who has attempted such an invasion has met with defeat. These facts have all helped to preserve Phase World's independence. The civilizations of the Three Galaxies have to accept the fact that all manner of illegal and immoral transactions occur there — almost everything done on Phase World is illegal somewhere in the Three Galaxies, from slavery and bloodsports to freedom of speech or the right to purchase and carry arms.

Center

Population Breakdown: 600 million inhabitants total, plus another 80 to 100 million in the orbiting space stations.

Prometheans 5%

Draconids 5%

Humans 5%

Phantoms 5%

Wolfen 4%

Seljuk 2%

Noro 1%

Others 73%; thousands of races from the Three Galaxies and the Megaverse visit Phase World. Typically, each represents less than 0.5% of the total population. Virtually all races of the Megaverse who have developed advanced technology or magic have at least a handful of individuals living or visiting somewhere at Center.

Center is an artificial mound, a mile high, and shining with a million lights at night. It is the oldest known building in the Three Galaxies, as well as the largest. It is revered as a religious shrine to the First Race (believed to be the city's original architects) and chastised by many as a den of iniquity. It is a gateway to infinite worlds and the central station of all spacelanes. A city where one can find incredible wealth and comfort, as well as Rifts-infested hellholes. Center is all that, and more.

As a shuttle approaches Center, its crew will see a white mountain, roughly square in shape, towering above the surrounding landscape. As it gets closer, details become clearer. Thousands upon thousands of ridges, windows, balconies, satellite dishes, and glowing runes mark the walls of the artificial mountain; a building with the land area of a large city. Every minute, scores of shuttles and small spaceships blast off into the stratosphere, as dozens more make their landings. Occasionally, a flare of Rift activity provides an awesome (and often dangerous) light show, as lightning bolts of impossible colors lick the

city walls, and strange cloud formations appear above its roof, sometimes taking the shapes of faces or monsters.

Center is the city's city. The streets are constantly filled with throngs of visitors. Everything is open around the clock. Merchants have three shifts a "day," and the selling, trading, gambling, dining and adventure never stops. The lights never go out, except in the places where there are few lights to begin with. Many people have been born, lived their lives and died in Center without every stepping out of it, and yet they will have seen more strange sights and known more cultures than many veteran dimensional travelers. In one of the many market squares, one can find kreeghor warriors haggling with kydians over the price of a rune sword, or elves examining a laser gun from a Naruni Enterprises representative. Dragons, demons and godlings walk the streets and even stranger sights are commonplace.

Many come to Center to seek their fortune. Most of them come to sad ends or discover that life is full of surprises, not all of them pleasant ones. Trillionaires can observe the world below on balconies in the first level of the megalopolis, while two miles below, rag clad, desperate beings resort to robbing corpses, scavenging garbage or even cannibalism to survive.



A **transdimensional visitor** who arrives to Center from a "Gate" (probably from a pyramid in some multidimensional trading center like Splynn or Worldgate), will find himself in an incredibly large way-station crowded with thousands of people of every shape and color milling around, entering or leaving through one of the hundreds of dimensional gates. A dozen exotic smells, and hundreds of alien noises and sights will threaten to overload his senses. Even as he tries to make sense of it all, an

official-looking draconid or prometean sitting behind a desk will address him, asking questions, and demanding an entry fee. Every so often, some disturbance will break out at one of the gates. A demon, perhaps, trying to get in without paying, or an angry godling picking a fight with the customs people, or a giant devouring monster that accidentally appeared due to a dimensional anomaly. A flurry of violence and some deaths later, things go back to their chaotic but relatively peaceful state. The offenders are carted away for disposal, or gated back to where they came from.

The unfortunates who arrive through a random rift in reality, either victims of a dimensional accident or adventurous shifters, will see a different side of Center. They are not likely to appear at one of the gates. If they did they could be sent back to where they came or, if that place could not be determined, put to work in this new alien environment (like it or not, conform or die). Instead, they are likely to appear on muck-covered streets, in poorly lighted areas. Garbage is piled in heaps in the alleys (is that a human arm protruding from it? Whatever it is, something that looks like a rat with feathered wings is dining on it). Sections of the wall seem to shift its appearance every few minutes (first they look like seamless plastic, then they acquire the shape of mossy castle walls, then they change to highly polished wooden surfaces, and back to plastic). People of all races (many the like of which they've never seen) scurry around cautiously, often clutching weapons, from swords to plasma blasters. In the distance, one can hear the occasional stray shot or even a continuous battle going on. If the new arrival is alone, a multi-racial group of unkempt strangers may approach, grinning evilly, trying to put their victim at ease before attacking. If lucky they are only out for booty and not blood. The city is filled with thousands of such unfortunate and often unwilling dimensional travelers. This is one of thousands of depositories of the Bermuda Triangle and places like it throughout the Megaverse. The most fortunate can eventually earn enough money to find their way back home. Others join the galactic community as space adventurers, mercenaries and laborers. Still others make their home (good or bad) in the dimensional slums of Center. Half don't survive a week.

City History

Several scientists have examined the city walls and dated their materials. According to the most advanced dating systems available, Center was built over five million years ago! This precedes every known galactic civilization and most cultures of the Megaverse. Not even the prometheans know who built the city. They admit their race didn't do it, but if they know more, they aren't talking. This has led to the popular belief that Center was the creation of the First Race, the mythical ancient civilization that built the Cosmic Forge. A number of cults have erected shrines in Center, where they pray to the Forge and the First Race. So far, their prayers haven't been answered.

The city is built on a super-nexus connecting seven major ley lines, and is crisscrossed by even more ley lines and dotted with small ley line nexus points. Rift activity is frequent, especially in the lower levels and around the surface. Most of the transdimensional instabilities and random disturbances in the area are channeled through a complex system of dimensional gates and fail-safes that make Center relatively stable and secure. This

same system that contains the ley line activity gives the prometheans incredible control over the mystic energies and allows them to open Rifts to a number of different dimensions and thousands of worlds. Dangerous, random dimensional disturbances occur mainly at the lowest levels of the great city where the dregs and castoffs of society are forced to live.

The Prometheans turned the city into an intergalactic and interdimensional center three thousand years ago, leaving it mostly in the hands of other races. The prometheans do not interfere with the city's inhabitants, as long as they present no threat to the rest of them or their planet. The promethean rulers of the planet have placed enough administrators and soldiers in the city to ensure it would function with relative smoothness and then leased the rest of it to the highest bidder. The more dangerous areas were all but given away to anybody who wanted a stake in them.

Many people wonder at the morality of the promethean rulers, since they have given permission to slavers, murderers and all kinds of miscreants and outlaws to set up shop on their planet. Even many first-stage prometheans find this fact very hard to understand and difficult to condone. Some think that Center is a transdimensional trap, that one day it will become a prison (or an execution chamber) for all evildoers within. Others fear that Center is controlled by forces that not even the Elders can stop, and that is why they have not put an end to the crimes that go on there. Such are the many legends of the Center. The Elders give no explanations and continue to observe in silence.

Many of the most important galactic and dimensional civilizations scrambled for a foothold at Center. **The Splugorth** tried to conquer the city shortly after it became a trading center. Their attack failed miserably, so they settled for leasing an entire section of city. This area has been remade in their image. **Naruni Enterprises**, perhaps the largest transdimensional arms merchant of the Megaverse, has its headquarters in Center. Weapon deals that can affect the future of entire solar systems are made or broken in offices whose windows face the bustling market squares on Level Four. The CCW, the Transgalactic Empire and half a dozen other galactic civilizations have embassies on Level One, from which all manner of plots and intrigue are hatched.

Besides being a bustling trade city, Center also offers all manner of tourist attractions. Some of the best entertainers in the Megaverse come to ply their trade in the city. Those looking for darker pastimes will also find them at Center, including bloodsports and other forbidden practices. The city is also an ideal place to hide. Pirates, smugglers and terrorists all flock to the lower levels of the city where the strongest rule and where there are few laws and fewer lawmen. By the same token, bounty hunters and undercover law enforcers often follow those criminals to the ends of the Earth, or in this case, their dark lairs on Phase World.

City Geography

Inside, Center is a labyrinth of epic proportions. The first four levels have a clearance of three to five hundred feet (91 to 152 m) and each of them is roughly the size of a normal-sized city. Three of those levels are divided into two sections by massive walls, allowing different cultures to coexist side by side. The size and diversity of the city can be staggering. To avoid being overwhelmed, many visitors prefer to stick to one section of the

city and try to pretend the others don't exist. Even many lifelong natives rarely know more than one or two levels of Center and would be as easily confused as a tourist in the other sections.

Getting Around

Traffic in any city is always a problem. In a multi-level city of 600 million, they only get worse. Each city level has a network of roads and sidewalks. They are wide and well controlled on the first four levels, but become narrow, dirty and chaotic on the last six. A system of monorails (just like subway trains, traveling in descending spiral patterns), elevators, staircases and ladders takes care of most of the traffic between levels. A few teleportation chambers (built with phase technology) take care of the rest. Inside some walls, a labyrinthine system of poorly-lighted ladders and stairs allow people who don't want to use the trains to climb up or down to their destination. The ladders are unguarded and unsafe in the bottom three levels, but well-watched by promethean security officers in the other seven.

Travelers between sections and levels have to go through checkpoints. In some places, the checkpoint is there more to prevent people from getting out of the section than getting in! Security at checkpoints ranges from letting people come and go with a nod to full body searches using technological and magical measures. The checkpoints are manned by a combined force of city guards and officers representing the particular sector. Details are given on each specific sector below.

Security

As far as the prometheans are concerned, security deals with only four things: damage to the city itself and threats to the planet at large, the transdimensional gate system, and the spaceport. As long as those areas remain secure, the inhabitants and visitors of the city are free to rob, abuse, murder and enslave each other as much as they wish. On a handful of occasions, full-fledged wars have erupted between city levels or sections, including one two year long conflict that killed over thirty million inhabitants! During these wars, access to the combat areas were sealed and every time the battlers tried to move to either the spaceport or the gateways, they were met by the overwhelming power of the promethean security force and the other city protectors. Eventually, the war burned itself out and it was back to business as usual (in most sections, things remained normal throughout the conflict).

The city itself appears to be absolutely indestructible. The prometheans know it was built using advanced phase technology that is beyond even their understanding or means (or at least, beyond the means of the phase-tech they share with other races). Even a multi-megaton nuclear explosion at point-blank range will not damage even the thinnest structural walls. Interior walls, most of which were built by the new inhabitants, are another matter altogether, but destroying them (and the people inside) will not damage the city's structural integrity in any way. The walls' invulnerability makes it very difficult to analyze them, because samples cannot be collected. Researchers can only try to do scans on their surface, which offers little information.

The dimensional gateway and spaceport sections of the city are heavily fortified. Force fields and phase-fields can appear in an instant to block access to the elevator cages, the runways and the stair systems leading to other levels. These fields can selec-

tively isolate these areas from some or all the other levels and sections of Center. There are only four gates leading out of the city and they can be shut down by sliding doors as indestructible as the walls of the complex. Promethean reinforcements can be teleported in as needed to besieged areas of rioters or invaders, while their phase fields make similar attempts at teleporting or dimensional gating (in or out) impossible for their enemies.

As long as visitors or residents don't antagonize the promethean authorities, they can fly out of the city and into space without restriction. If a bounty hunter captures somebody and shows legal papers (from any civilization — the prometheans aren't picky) demanding the prisoner's capture, he is allowed to carry off his captive. If the outlaw manages to escape and tries to fly back to Center, he is allowed to do so as well. Frustrated bounty hunters and lawmen can only expect basic information from Center authorities, like, "Yes, the man you seek did arrive back at the spaceport. He headed to the lower levels. Don't know exactly where. Good day." There is no degree of cooperation or interference. They neither harbor criminals and refugees nor expel them from the city. "What is, is." and "Those who know, know." are two common phrases among the authorities and merchants of Center.

Despite this apparent apathy, each smaller section of the city provides its own security and they can be a lot less tolerant, anarchistic or helpful than the prometheans. At the Manors, for example, visitors are screened carefully and are not allowed in without a valid reason for being there. The first four levels are fairly careful about allowing in any heavy weapons, known criminals, dangerous demons, and other undesirables. In the lower levels, however, everything goes. Some sections are controlled by powerful criminal gangs and they may take violent or extreme issue with unwanted visitors, especially knights and law officers. Likewise, many corporations and merchants employ their own private security force (army). These troops can be of great assistance or hinderance depending on who they are, whose involved and the exact situation.

Living Conditions

The logistics of keeping almost a billion citizens and visitors supplied with water, food and air, plus the messy business of waste disposal, would be overwhelming even for the highest technological civilizations of the Three Galaxies. The city, however, was designed by a technology centuries ahead of the most advanced known races. It is believed that Center may be controlled by a sentient computer, hidden somewhere beneath the lowest levels of the city. Many expeditions have braved the darkest catacombs below Center, trying to discover this miraculous control room, but they have returned empty-handed. Still, many keep trying, because discovering this place would mean absolute control over the city.

Climate control is excellent. Nobody knows where the air and cooling systems are. Some speculate that the air is dimensionally gated from other worlds as needed. The temperature ranges from 60 to 70 degrees Fahrenheit (16 to 21 C). Large-scale fires are drowned out by water that comes out of nowhere, or chemicals that smother fires that water cannot extinguish. Again, these measures seem to use magic, phase or teleport technologies beyond anything known to the Three Galaxies. There are also no adverse problems dealing with air pressure which should be very

high one mile below the surface. A low-grade phase field somehow prevents pressure from crushing people even if they go into the catacombs that are said to run miles below the city!

Food dispensers will sell prepared or raw foodstuffs (the latter is cheaper). Payment can be made in credit or by placing valuables in the same tray that teleports the food in or out. The food is imported from other planets, dimensions or from the surrounding countryside. Occasionally, in the lower levels, a group will try to control the food supply and starve out those who cannot afford their inflated prices. Usually, the would-be hoarders end up getting themselves murdered by angry mobs.

Waste products are also teleported away. The sewer system leads to a dimensional gate that dumps the waste on a gas giant in the same planetary system as Phase World. Garbage bins will teleport away any non-living things placed there. A favorite way for criminals to dispose of corpses is to simply dump them in the bins.

City Highlights

Described below are some salient points and important characters of the city. Future Phase World sourcebooks will expand on this information.

Level 1: The Manors

People of all races and origins live in the Manors. They have one thing in common, money. Lots of it. The cheapest piece of property in the Manors costs millions of credits. Only the fabulously wealthy and their servants live there, enjoying decadent luxuries that would make a Roman noble blush. Anything can be purchased in Center, and the lords of the Manors can afford to buy any of it, from the best magical and technological security systems to the most sophisticated or corrupt forms of enjoyment.

This level is one of the most beautiful sights of the Megaverse, filled with enormous palaces and ornate apartment buildings. Some are surrounded by spacious gardens that simulate hundreds of different ecosystems. Others are domed complexes that project a different holographic landscape every day. Colorful towers rise to the domed ceiling, 700 feet (213 m) high, large enough to have small cloud formations. Holograms create a perfect illusion of daylight, which can be changed to night for selected sections of the Manors, while keeping the rest well lit. The streets leading to and from the diverse mansions and buildings are broad and clean. Motorized traffic is kept to a minimum to avoid disturbing the residents. There are no shops or markets, instead, merchants bring their wares to the presence of the magnates or servants are sent to the lower levels to get whatever their masters desire. Although this section is as big as any two sections of the lower levels, the population is small, about one-third the size of the average city level.

Despite the opulent life style, the Manors is not a happy place. Tension, hatred and fear are thick in the air. Servants fear their masters, who can fire, destroy or even kill them at a whim. Relatives fear, hate and envy one another, often conspiring to win inheritances, or to cheat or steal a bigger piece of the pie than their siblings. Rival households try to outdo or destroy each other. Although they have the best protection money can buy, the

Lords and Ladies (as they are collectively known) are often assassinated by those close to them. A few have become hermits, living in palaces by themselves and attended to only by robot servants. Others figure out that the best way to remain safe is to do unto others before they do unto you.

Since Center does not have a real government, the various sections and levels establish their own laws and leadership. The first resident of the area is the mysterious and possibly immortal man known as Thraxus (described later). He is also the governor of the First Level. He oversees the enforcement of the Compact he himself wrote. The Compact is a contract that every resident of the Manors must sign before being granted the right to live there. The rules are full of legalese, but they boil down to one thing: anything goes inside a person's home, as long as it does not become obvious, embarrassing or dangerous to other residents. There is also an unwritten law that the residents quickly learn: As long as you can bribe your way out of a problem or pay to cover it up, anything goes beyond one's home — as long as it doesn't anger Thraxus or one of his cronies.

Some Places of Interest at the Manors

The Checkpoints: Every entrance to Level One is heavily guarded. A private guard team made up of the best cutthroats money can buy (supplied by Naruni Enterprises) with a small contingent of promethean guards, stands at each checkpoint. Visitors have to present identification and a satisfactory story before they are allowed in. If their story is not acceptable or does not check out (for example, if somebody claims they are visiting a resident, the resident is called to confirm the story), they are fined 1D6×1000 credits (the exact amount is usually at the guards' discretion!). If they cannot pay the fine, payment can be extracted in goods (i.e., anything the unfortunate was carrying on him) or in labor (1 to 3 months forced labor)! This policy tends to discourage "undesirables" from pestering the checkpoint guards.

Thraxus' White Tower: This building dominates the Manors' sector. Built all the way to the ceiling of Level One, the White Tower is an ivory-colored, round, featureless tower that almost appears to be a column supporting the vaulted ceiling. The tower is on top of a hill and is 500 feet (152 m) tall and 70 feet (21.3 m) in diameter. People who are allowed in, discover that the place is larger on the inside. The tower is some sort of dimensional gateway or some sort of dimensional pocket in large scale. The decor and shape of the interior is always changing to suit the whims of Thraxus, the wealthiest man in the city. Some favorites include a 17th Century Earth royal courtroom of French style, an ultra-tech control room aping a starship's bridge, a jungle motif with living plant furniture and gorilla-like servants, and a desert background with a richly furnished tent where Thraxus welcomes visitors. Naruni Enterprises' Board of Directors sometimes holds private parties and informal get-togethers at the White Tower.

The Embassy Buildings: This is a luxury hotel and apartment building owned by Thraxus. Its apartments can be rented, leased or sold to important (and wealthy) visitors at outrageous prices. Rent starts at 100,000 credits a month and that's for the smallest studio apartments! The apartments have all types of comforts, including full room service (optional) and mini-swimming pools or jacuzzi facilities inside the apartments them-

selves! Magical and technological entertainment services and the best furnishings are readily available. As its name indicates, these buildings also house, at reduced charges, the ambassadors of several space and transdimensional civilizations. These embassies only deal with the most important heads of state. Level Two has consulates that take care of the "common people."

The interactions between the different embassies and the wealthy residents of the Embassy Buildings could fill a hundred spy novels. Bribery, espionage, blackmail, disinformation campaigns, rumor-mills, discrete liaisons, sexual affairs and the occasional burglary and murder are the order of the day at this establishment.

Level 2-A: Gateland

Gateland occupies the west half of Level Two. This is where dimensional gates are regularly opened to some 800 locations across the Megaverse. It is also where dimensional traffic is at its thickest and most chaotic. An entire corps of prometheans (over 15,000 soldiers and 1,500 Phase Adepts) is stationed on this level to deal with any disturbance. Additionally, two city guard divisions (20,000 soldiers of diverse species, equipped with Naruni Enterprises weaponry) is also present and ever alert for trouble. To add to this impressive manpower, there is a Special Brigade of 1,200 magicians, super-powered beings and supernatural D-Bees. Additional troops can be teleported in from military bases elsewhere on Phase World. On one occasion, over 100,000 soldiers were called in to deal with a supernatural intelligence that was trying to break into the city. After a savage battle that killed thousands of soldiers and innocent bystanders, the entity was destroyed.

There are 1,280 gateways arranged in a semicircular pattern on the southwest corner of the city. Each gateway leads to a different place. Some have been inactive for decades or centuries, while others let in tens of thousands of visitors every day! The gateways are connected to pyramids, permanent Rifts, magical portals, and dimensional teleport devices across the Megaverse. Some are largely unknown by the natives of that dimension and used only by those with secret knowledge. Others are common portals of travel known by all. Some gateways can be calibrated to go to more than one place, or to accept visitors from several different dimensions.

Some of the dimensions these gateways lead to include:

Rifts Earth: Five gateways are connected to Rifts Earth. They lead to: *Splynn in Atlantis*, where they are used by a number of transdimensional traders (with the exception of Naruni Enterprises, traditional competitors and enemies of the Splugorth); the *Evil Millennium Tree in Europe* (see **Mindwerks**), used mostly by supernatural beings and evil sorcerers; the *City of Cibola* in the Amazon Jungle (see **Rifts South America**), an important trading center for Naruni Enterprises; the *Yucatan peninsula* (see **Rifts Vampire Kingdoms**), and a *secret Naruni Enterprises facility* in North America.

Wormwood: Two gateways are connected to this planet. One at the city of Worldgate which is used mostly for transdimensional trade, and another in a deep cave with a ley line nexus, in the heart of the Unholy's territory. The cave nexus is used by a number of champions of good to stage guerrilla raids against the Unholy (Note: The discovery of this gateway by the dark forces

that control the planet could lead to attacks against Center from the Unholy's minions). These gateways are restricted to a number of authorized users and very few (less than 50 people) know of their destination. The prometheans have kept the existence of Wormwood from the Splugorth and Naruni Enterprises, for reasons known only to the giant Lords of Phase World.

The Plain of Mist: Three gateways are connected to this mysterious dimension of rolling mists and featureless white sky. This seemingly endless plain is said to be a major transdimensional terminus with gates to thousands of worlds, some of which can only be reached from there. The place is a featureless desert, except for the occasional Millennium Tree, city, or fortress town, and for the long caravan chains traveling through it. Traffic to and from the Plain of Mist is incredible, with thousands of visitors and kilotons of merchandise entering and leaving each gate every hour! Each gate is built around a fortified city. The smallest has a population of 50,000 people of diverse races and the largest has over 10 million inhabitants. All kinds of wares are purchased in the Plain of Mist and brought back to Phase World where they quickly find a market. The transdimensional merchants known as the *Plain Riders* have become enormously wealthy, but theirs is a very risky profession because the Plain of Mist is one of the most dangerous places in the Megaverse, beset by transdimensional bandits, monsters and supernatural intelligences.

Megalopolis/Olympia: This dimensional realm is connected by one gate to Phase World. The gate is in Megalopolis, a huge city peopled by demigods, M.D.C. humanoids (similar to the natives of Wormwood), cyclops (both lesser and greater), dozens of D-bee races, and the occasional godling. Megalopolis worships the Pantheon of Olympia (see **Rifts Conversion Book Two: Pantheons of the Megaverse**), which overlooks the city from the immense mountain known as True Olympus. The city borders a seemingly endless sea and is surrounded by forests full of mythological creatures and monsters. There is a brisk trade of magical items and weapons as well as some technology and techno-wizardry. The cyclops are renowned weaponsmiths and their lightning arrows, spears and javelins always bring an excellent price. The gods of Olympus have been known to use the gate for occasional visits to Phase World, either to make purchases (the god Hermes is a great customer of fast vehicles and exotic weapons) or to use the gates to go elsewhere.

The Scorched Lands: This dimension is covered by black rocks and sand under an angry red sky. Travelers arrive through gates that open through *dolmens* very similar to the ones found in Stonehenge. Four very active gates lead to this dimension. The scorched lands are connected to *Dyval*, the demonic plane; *Hades*, the Greek death-realm, and the *elemental planes* of fire and earth. A few cities are scattered among the black mountains. Their inhabitants are dedicated mostly to mining and metal working; the black lands have incredibly rich metal deposits. Despite frequent raids by demons and elementals, the scarcity of food and water, and other dangers, these cities have grown and prospered, largely because very valuable minerals, including psyllite, uranium, and some rare and exotic metals and gems are found there. A great deal of trade is conducted between these cities and Phase World. One of the cities is run and controlled by Naruni Enterprises — the city became indebted to the corporation and when they couldn't meet their payments their mines

were seized and they now work as slave labor. A stark reminder of the dangers of doing business with the Naruni.

The Ugakwa Homeworld: This is a dimension covered in a thick atmosphere and light gravity. It is the homeworld of the ugakwa Explorers described in **Rifts Mindwerks**. The ugakwa have become a market for technology and also export their own products, including powerful force fields superior than those sold by Naruni Enterprises.

Others: Two gates are connected to the *Palladium World*, but are only used by the occasional dimensional traveler. These gates are unique in that their location keeps changing over time — the gates seem to be moving around the planet! Other gates connect to several versions of 20th Century Earth, including the world of *Heroes Unlimited* and *Ninjas and Superspies*. Many of the gates reach dimensions controlled by the Splugorth, Naruni Enterprises, and ancient "divine" pantheons.

Some Places of Interest on Level Two

Dimensional Checkpoints: Each gateway is surrounded by force field fences (M.D.C. 1000) and arrivals will be questioned by a promethean inspector backed up by a squad of soldiers of diverse races. Gateways with a lot of traffic will have dozens or hundreds of inspectors assigned to them to help speed up the arrival process. The visitors will be asked their business and intentions in Center. If the promethean and the arrivals don't have a common language, magic or a technological translator will be used. If the visitors have heavy weapons, power armor, robots, etc., and are not willing to leave them in storage, they are allowed to go to levels 7-10 through a special elevator that only goes to those levels. Otherwise, they have the run of the second level and will have access to all the other levels and sections; provided, of course, that they can get past those sections' respective checkpoints.

Hostile arrivals will be countered immediately. The guards will try to drive intruders back through the portal which will then be closed for 1D6 hours. Reinforcements will arrive quickly, equipped with heavy weapons and assisted by magicians and psychics.

The Central Station: This sector is exactly between section 2-A and section 2-B (see the Space Port, below). The Central Station has the main monorail system that leads to levels 3-7 and has massive elevators that go to all ten levels. The Central Station is a chaotic place usually filled by hundreds of thousands of new arrivals. The place is big enough to deal with a crowd in the millions. Hundreds of monorails leave in different directions every minute or so, and about 5,000 elevators are evenly spaced on three walls. The monorails are clean and well kept. Their seats are self-adjusting, able to accommodate any humanoid between 4 (1.2 m) and 12 feet (3.7 m) tall comfortably. Each elevator is the size of a house with a clearance of 50 feet (15.2 m)! They are often used by oversized creatures that find the monorail accommodations too cramped.

Security at the station is heavy. In the event of a fire or other major disturbance, the entire station is filled with force fields (1000 M.D.C.) that divide and isolate the whole area in 20×20 foot (6.1×6.1 m) squares! This prevents riots and mass combat from breaking out and security can release innocent bystanders while leaving the perpetrators trapped in one or more force fields.

The Warehouse Sector: This area is also shared with level 2-B (see below). This is where merchants take their merchandise for transport to the other sectors or levels. The massive warehouses take up almost a third of the entire second level. Trucks and forklifts are constantly moving crates, chests, and boxes. A complex computerized and magical system keeps track of the merchandise, making theft or losses a rarity. This sector also has a strip of office buildings, filled by shipping companies, wholesale buyers, insurers, and traders. Most large-scale transactions that do not involve one of the open markets in the lower section are usually conducted here or on the space stations.

Level 2-B: Space Port

The other half of level two consists of thousands of landing pads for space shuttles and cargo ships. The largest space port in the Three Galaxies is located here, and is the size of a small city. Shuttles with a cargo capacity of as much as 100,000 tons (90,700 metric tons) land every few minutes on one of the landing pads that rim the outside of the city. Spacers and passengers from all corners of the galaxies crowd the walkways leading to the Central Station, or to Spacetown, the favorite hangout of most pilots and ship crews.

Places of Interest on Level 2-B

Spacetown: Spacetown has all the amenities spacers could wish for, including inns, taverns, night clubs, and other entertainment areas. This is where pilots go to hang out, trade tall tales, get drunk or start friendly brawls. The dozens of bars found there are also a good place to find new jobs, hire a pilot or an entire ship, or listen to the rumor mill. Two kinds of people frequent this place: Spacers who wish the company of their own kind, and non-spacers who are there to hire, admire, or “slum” with the spacers. The two groups don’t mix together very well and some bars will not let in anybody who doesn’t look like a true spacer. Some go so far as to prohibit anybody who isn’t a regular or a guest of a regular.

The Shipyards: Hundreds of ships are being repaired, customized or built at any given moment in Center’s massive shipyards. This is the place to go to buy, sell, repair or improve small ships (under 1,000 tons in weight/907 metric tons). Larger ships are dealt with in the surrounding space stations. Many research and development corporations have set up shop in this area, and prototypes of new and improved space drives, ship weapons, sensor systems and other ship parts are built and tested here. As a result, industrial espionage is rampant in this area.

Level 3-A: Splugorth Trading Post

This sector is mostly peopled by Splugorth minions, monsters, inhuman looking aliens, and supernatural creatures. After the last attempt to conquer Phase World failed, a Splugorth named Klynncryth (Lord Klynn for short) made a deal with the prometheans. In return for leasing rights on a sector of the city, Klynn would ensure that no further attacks would be made against Phase World. So far, both parties have kept their side of the bargain and Level 3-A is one of the most important Splugorth cities in the Megaverse. The recent opening of the city of Splynn in Atlantis (see **Rifts Atlantis**) has somewhat eclipsed the popularity of Klynn’s “city,” but it still remains a major trading center.

Lord Klynncryth seems content with his place in the Megaverse. Unlike most Splugorths, he has not tried to increase his power at the expense of his neighbors. However, it is rumored that Klynn is simply biding his time, and that he has his eye on one day becoming the ruler of Center and the master of the secrets of phase technology. Lord Klynncryth’s agents are everywhere, in the city, at other locations on the planet, the space stations, and other key locations throughout the Three Galaxies. He is very well informed about all the goings-on throughout the galaxies.

Level 3-A is a very active trading center and is very popular among non-humanoid races. Humans, elves, wolven and other humanoids are not welcome, and such visitors are often met with contempt and hostility. The kreeghor race abhors the Splugorth and their minions, so very few members of that race venture into this sector unless they are looking for trouble. The only exceptions to this rule are humanoid pirates and criminals who often arrive to sell slaves or stolen articles. This level is also a “tourist” attraction for many of the most bloodthirsty species in the Megaverse, who travel from all over to see the gruesome spectacles presented at the *Blood Dome*.

Sector 3-A has its own transdimensional network, using a pyramid built on one of the many ley line nexuses found in the city. The pyramid is connected to several Splugorth controlled worlds, with the notable exception of Atlantis; Lords Klynncryth and Splynncryth do not get along and have been quiet rivals for over 10,000 years. Demons, dragons, elementals and other inhuman beings often arrive at Center through the pyramid.

A large segment (over 20%) of the sector’s population belongs to the kittani race (see **Rifts Atlantis**). The kittani belong to an ancient spacefaring race, and they feel very much at home in the high-tech setting of the Three Galaxies. The rest of the population is evenly divided among kyidian overlords, powerlords, metzla, slave races and other minions. Slavery is widespread in the sector. This and other inhuman brutality bothers many civilized inhabitants of the Center. Due to this, and the general hostility towards humanoids, traffic between Level 3-A and other sectors is minimal.

Places of Interest on Level 3-A

The Blood Dome: This giant enclosed stadium is Lord Klynn’s answer to the Atlantis Arena. Monsters and slaves participate in all manner of blood sports, from duels to pitched battles involving as many as a hundred participants! Special nights also offer savage executions to entertain the most depraved of souls. These gruesome spectacles attract monstrous spectators from across the Megaverse. The Blood Dome has a “stable” of regular gladiators and monsters, although the attrition rate among both is horrifying. It also welcomes independent “entertainers” who bring exotic slaves, gladiators or pets to the Dome to pit them against the best local talent.

The Blood Dome can seat up to 100,000 spectators, both humanoid or giant-sized. Special events (the Monthly Monster Mash is the most popular) are televised/holovised on a pay-per-view basis. People anywhere in Center who pay a 50 credit fee can watch the event from their homes or hotel rooms. The Monthly Monster Mash usually gets as many as 70 million viewers!

The Dimensional Market: This large open market is not quite as impressive as the Splynn Dimensional Market of Atlantis, but it comes very close. The wares from dozens of Splugorth controlled dimensions, and traders from hundreds of worlds can be found there. The Dimensional Market does not get a good variety of articles from the Three Galaxies, however, due to the Splugorth's bad reputation and the resentment of the local inhabitants.

Level 3-B:

The Open Market/Wonderworld

Separated from sector 3-A by a huge structural wall, the Open Market is an area where small and medium-sized businesses can rent out space to sell their wares. This section is also well known for *Wonderworld*, one of the largest arcades and entertainment centers in the Three Galaxies. Tourists, merchants and collectors all flock to this area. This is one of the most active sectors of the city, with merchants haggling with customers every hour of the day and night. Most of the stores are highly specialized, usually selling the wares of one planet or even a single type of item. Exotic perfumes, toys, weapons, clothing and antique stores are all common. Spices from far off worlds, or alien dimensions are sold side by side with 17th Century Earth antique clocks, virtual reality game cartridges, and fancy dresses.

The sector is divided into districts, and some are more high-ten than others. Permanent residents live in neighborhoods ranging from comfortable and luxurious apartment buildings to crime-infested slums. In the slums, some crime gangs are so well armed and organized that they sometimes venture into the well-lit shopping centers for a quick stick-up or mugging. However, most crimes on this level are non-violent and consists primarily of con-games, the sale of substandard or fake merchandise, pirated CDs, and similar rip-offs. There is nothing like a Consumer Protection Agency at Center, so buyers beware!

Security in this sector is provided by private police services paid for by the Merchants' League, a loose association of store owners. These rent-a-cops watch carefully for disturbances, shoplifting, and robberies. In any dispute between storeowners and customers, they will take the storeowner's side. The private police dresses in bright blue uniforms and are armed with lasers and stunners.

Places of Interest on Level 3-B

The Hy'werth Jah'Shum Inns: This transgalactic franchise of hotels and restaurants have no less than twelve hotels and motels on this level, each covering an area of the open market. The hotels, commonly known as Hi-Jahs, are reasonably priced with comfortable rooms averaging 40 to 100 credits a night. The food is second rate, but cheap. Several dozen copycat hotels also crowd the sector's streets.

Wonderworld: Towering over all other structures in the sector, reaching all the way to the ceiling, is Wonderworld. It looks like a "miniature" version of Center itself. The compound is a combination theme park, arcade, movie theater, circus and art gallery. Licensed by the Paradise Foundation, Wonderworld is filled with rides, virtual reality games, simulation rooms, exotic acts, strange animals and other attractions. Although it cannot compete in scope with the Paradise planets, Wonderworld attracts

many tourists. The entertainment offered here is for the most part, wholesome "family-oriented" fun. Weapons and controlled substances are strictly forbidden, and the staff is trained to be cheerful and polite under every circumstance — even while hauling away a "rejected" customer.

There are rumors that some areas of Wonderworld cater to darker, forbidden lusts and pleasures. However, no such allegations have been proved and most people figure that the neighboring Splugorth sector provides enough evil forms of entertainment to satisfy anybody. The rumors continue, however, claiming that these secret rooms provide things that not even the Splugorth would touch!



Level 4-A: Free Trade Zone (FTZ) (Naruni Enterprises)

The Free Trade Zone is commonly known as "the Big Lie" by the citizens of Center. The so-called "free zone" is tightly controlled by Naruni Enterprises, the largest arms dealer of the Megaverse. Although the Zone does not limit itself to the sale of weapons, everything in it has a military theme. Naruni Enterprises is a firm believer in merchandising and the zone offers many different things to visitors.

First and foremost is the weapons trade. Almost one-fifth of the entire sector is a giant showcase of military technology. Handguns, rifles, vibro-blades, explosives, personal force fields, hover tanks, artillery pieces and exotic gadgets are exhibited and demonstrated around the clock. Even though most tests are conducted in sound-proof buildings, echoes from the largest explosions and energy discharges can be heard throughout the level.

War veterans who visit the FTZ always feel uneasy because of the echoes, which bring about many bad memories, and arouse old combat senses. Buyers representing governments, mercenary companies, and more unsavory organizations all line up to observe and choose implements of destruction.

Of course, that is not all Naruni offers. A lot of subsidiaries have grown side by side with the weapons merchants. Among them is the entertainment industry. Movies, virtual reality programs, and interactive shows have been developed around the weapons Naruni sells and the people who use them. Naruni has been known to offer discounts, or even supply free weapons and equipment for participants in a real war in return for exclusive media rights to that war. Teams of filmmakers follow the soldiers around, capturing their life-and-death struggles. Sometimes micro-cameras are strapped on or implanted into the soldiers' bodies, recording everything up to and including their death agonies. The footage is then doctored up and enhanced into the finest movies, holograms, virtual reality shows and even full-sensory "feelies" money can buy. "Feelies" are sensory spectacles in which the viewer/participant is plugged into the action and fully experiences everything recorded in the programs. The FTZ has many theme parks that show these movies and which offer rides and holographs simulating combat. Annual championships for combat simulation computer games attract their share of crowds too.

Toys mimicking the weapons Naruni Enterprises manufactures are also very popular. Some people suspect that Naruni pushes those toys to create instant product recognition. In this way, children will grow up wanting to own a real Naruni plasma-cartridge rifle. If these children grow up to become soldiers or government officials, their subconscious desires might lead them to making purchases of real Naruni guns one day.

Additionally, fake suits of armor, posters, holograms, books, electronic magazines and other licensed merchandise are sold in the Free Trade Zone. Naruni Enterprises has had centuries of practice to master the art of squeezing the last credit out of their properties.

Places of Interest on Level 4-A

The Demo Rooms (DRs): These heavily fortified buildings are filled with shooting ranges, simulated battle-sites, and test rooms. Customers can try their weapons in these rooms. Anything smaller than a tank can be test-driven, shot, or tested. The Demo Rooms are heavily guarded in case of an attack or raids. Their corridors are sealed by armored doors and each DR becomes a bunker with enough firepower to damage a starship.

The Mechaboy Arena: This is the site of Naruni Enterprises' famous Space Wars game, a holographic/virtual reality game where the players each pilot a ship, robot or tank and participate in huge simulated battles. A number of competitions, both individual and teams, are held every year. The most famous being the Mechaboy Championship, in which an all-out fight between simulated robots (all based on licensed Naruni Enterprises systems, of course) determines who the new Mechaboy Master will be for the coming year. Sometimes, a few Mechaboy Masters have discovered a taste and an aptitude for the real thing and have gone on to become mercenaries or even members of one of Naruni Enterprises' dreaded troubleshooting squads.

Level 4-B:

The Warlock Market

This sector is headed by the *United Worlds of Warlock* (described later), a confederacy of planets that rely on magic to travel through space. The Warlock Market is a center of technowizardry. Products from the United Worlds of Warlock and all corners of the Megaverse are bought and sold here. Alchemical potions, magical weapons, mystic armor, magical scrolls, exotic pets and familiars, and all manner of things arcane can be found in the bustling streets of this market. Even the occasional rune weapon can be purchased here, although they are very rare and expensive. While the Warlock Market is not quite as well-stocked as the Splugorth-run transdimensional emporiums or the city of Splynn, it has the advantage of not being hostile toward humanoids.

The entire market is a strange, wild place. Outbursts of unexpected magical activity are common, although thankfully, Rifts or ley line storms have only occurred three times in the history of the sector. Still, elementals often run wild through the streets, or a summoned creature somehow manages to break free and wreaks havoc on the streets. The security patrols of the market always have at least one magician or warlock with them to prevent too many mishaps from happening.

There are also three magical universities famed throughout the Megaverse, and dozens of lesser schools located on this level. A few of these places are traps for the unwary, where fools without an ounce of magical potential are taught a great deal of useless mumbo jumbo for outrageous prices. However, most of the schools are legitimate and run by true magicians, warlocks and sorcerers. The universities are funded by a few wealthy patrons, but make most of their money by selling their own scrolls, potions and magical items, as well as by charging very high tuitions. However, their tutelage is of superior quality and serious students of the mystic arts can learn much about magic, supernatural forces, gods and dimensional travel.

Places of Interest on Level 4-B:

The Institute of Magical Arts: This is the largest magical university on the level. All traditional magic systems, including both ceremonial and elemental magic, are taught here. There is even a very small and exclusive Department of Temporal Magic, staffed by an ancient temporal raider (see **Rifts England**). This department accepts and teaches only a handful of deserving pupils. Technowizardry, circles and ward making are also part of the available curriculum. Tuition is an amazing 100,000 credits per semester (not including materials, room and board), but very promising students may be granted scholarships in return for a term of servitude to their benefactor. Many teachers and their assistants at the Institute are former students paying off their tuition.

The Lower Levels: 5-8

These areas are not as well-known and frequented by visitors. For one, they are relatively smaller. While the first levels have a clearance of hundreds of feet, the lower ones only have a 100 foot (30.5 m) ceiling or less (becoming smaller at each level). Their streets are narrower, dirtier, and they have less in the way

of open spaces and tourist attractions. Levels 5 and 6 hold the residential quarters of most long-term citizens of Center. Small apartment buildings, shopping centers, and a few parks fill these areas. There are a few manufacturing plants and other sources of employment, but about half of the inhabitants work in the upper levels. Levels 7 and 8 house the poorest residents, the unemployed, and undesirables.

Each level resembles a small city. Like most cities, they have their good and bad areas, places where the well-to-do enjoy luxury and places where it is not safe to walk the streets. The local constables usually guard the people who “deserve” protection and ignore the poor and downtrodden who are easy prey to criminals. These sectors attract some tourists looking for such forms of entertainment as prostitution, high-stakes gambling, and exotic drugs.

The lower levels are the place to get goods not readily available up above: smuggled items, pirated copies of all kinds of articles, dangerous and experimental drugs and other illegal (even in Phase World) products can be found in the slum areas of these sectors, especially on level Seven and Eight. Powerful street gangs control whole city blocks and regulate the city’s Black Market.

Places of Interest on the Lower Levels:

The Checkpoints: The checkpoints at levels 5 and 6 are reasonably strict and well-manned. At levels 7 and higher, however, vigilance is minimal and almost anybody can be let in, even people with heavy weapons, suspicious packages, slaves, captives or carrying unconscious bodies. Once they are inside, they are on their own and getting out of the lowest levels is a lot harder than getting in.

The Rat Nest: Located on Level Eight, this area has been staked by the Society of the Knife, a shadowy organization that runs a great deal of illegal businesses in Center. The society’s leader, the mysterious Knife Master, controls the Black Market. No major deals can go down in the area without his consent. The Rat Nest is the size of an entire city block. Abandoned buildings have been outfitted with stalls that are rented out to drug dealers, smugglers, prostitutes and other criminal miscreants. Gangs of armed thugs patrol the area and personal bodyguards are as common as flies. Outbreaks of violence are common and lone visitors are often ambushed, robbed and beaten — if they are lucky.

The Rift Levels: 9-10

The last two levels of Center are the most dangerous ones. Only people who have nowhere else to go, and a few madmen who want to be there, dwell among their dark corridors. The original purposes of these levels are unknown. They may have been used as a sewer system, or for maintenance crews. These two levels have a mere 20 foot (6.1 m) ceiling clearance and the streets are narrow and poorly lighted, inspiring claustrophobic feelings in visitors. The checkpoints leading to this area are more concerned about keeping things out than letting people in. Most long-term residents are supernatural monsters and their victims. People convicted of crimes against the city are often tossed into these levels without any weapons and equipment and left to fend for themselves. Victims of the Society of the Knife, escaped slaves, refugees, victims of random Rifting, the poor and the insane also number among the hundreds of thousands of residents.

Life expectancy in these areas is low. Even so, people manage to survive, trading among themselves, saving enough money to buy food from wall dispensers, or engaging in cannibalism or worse. Some bands of criminals and supernatural predators live here and raid the upper levels using secret tunnels known only to them. Sometimes, an armed party descends into these levels in search of some stolen valuable or victims of kidnappings, braving the dangers of insane cultists, alien monsters and worse.

Hundreds of unfortunates find themselves Rifted into these levels from other dimensions. Rifts open and close randomly in different places. Another strange thing about the two levels is that they are crisscrossed with ley lines. Magicians in these levels will get all the benefits of being near a ley line and minor ley line nexuses occur every few blocks. This prompts some magicians to travel down below to use the magical energies available there, or to enlist the supernatural monsters attracted to them.

Some Notable Citizens

Thraxus

Ruler of the Manors

Thraxus is the oldest resident of the Manors level and of the city itself. Center’s records go back for 5,000 years and Thraxus has been listed there every year, starting with the first. He is reputed as being the wealthiest man in the Three Galaxies. He sits on the Board of Directors of Naruni Enterprises’ Three Galaxies/Phase World franchise, and is an important shareholder in this transdimensional corporation. Those holdings alone are worth trillions of credits and they represent only a fraction of what he owns. From shipyards to casinos, Thraxus owns all manner of property through the Three Galaxies, as well as other dimensions. Nobody knows where the magnate came from. He is obviously a supernatural being of some sort, having lived for thousands of years. Further proof of his superhuman nature has been shown every time somebody has tried to assassinate him. The would-be killers have always failed spectacularly. It is rumored that Thraxus is a godling who amassed his fortune after millennia of adventuring through the Megaverse, murdering all manner of creatures to steal their goods. This rumor seems to be confirmed by Thraxus’ comments about his old “dungeon crawling” life. Some tales even claim that Thraxus started out as a mortal adventurer and that he somehow gained, stole or otherwise acquired his godling powers.

Thraxus is concerned with only two things: making sure that the Manors (which he sees as his personal domain) remain quiet and undisturbed, and entertaining himself. This entertainment can be anything from exotic spectacles to simple conspiracy. Thraxus loves to plot against other powerful beings. He sees life as a game and enjoys pitting his resources and wits against worthy opponents. He doesn’t even mind losing, as long as it happens in an entertaining manner, and he doesn’t lose more than he can afford (the latter instance has never happened).



John N

Many adventurers have been called to Thraxus' White Tower to perform diverse missions in his many schemes. While he prefers willing participants, he is not above bribing, blackmailing or extorting "pawns" to do what he wants. For instance, he has often convinced cosmo-knights to perform quests for him in return for billions of credits' worth of aid to a worthy cause. In other cases, he has kidnapped a hero's loved ones and used them

to gain the leverage he desires. His missions can be something as simple as delivering a package to another planet (however, all too often somebody else wants the contents of the package very badly). Or they can be as complex as stealing a holy relic from a heavily-guarded planet dominated by religious fanatics and making the theft look like it was conducted by a rival faction.

Thraxus' anarchistic nature and delusion that life is just a game, means he is as likely to be found fighting for good causes as against them. He has foiled the Splugorth several times and as a result, he has been the target of numerous Sunaj assassins and other minions. He has also been the nemesis of many champions of light. Who he sides with often depends on how he perceives things, the challenge of the "game," and which side of the bed he woke up on.

Alignment: Anarchist with leanings toward miscreant.

Attributes: I.Q. 24, M.E. 30, M.A. 27, P.S. 20, P.P. 19, P.E. 23, P.B. 17, Spd. 16; supernatural attributes.

M.D.C.: 684

Horror Factor: 9 for those who know of his reputation (awe)

P.P.E.: 30

O.C.C.: Godling

Level of Experience: 15th level godling

Natural Abilities: See the invisible and turn invisible at will, resistant to poison, drugs and toxins (half as effective), nightvision 200 ft (61 m), fire and cold resistant (does half damage), regenerates 1D6x5 M.D.C. per minute, and can fire energy blasts doing 8D6 M.D. (range: 1000 ft/305 m).

Disposition: Thraxus is a consummate manipulator.

Psionic Powers: None

Magical Knowledge: None, but has an extensive knowledge of magic lore, weapons and artifacts. He owns dozens of magical items with spell-casting abilities and combat properties.

Combat abilities: Hand to Hand: Expert

Attacks Per Melee Round: Six

Bonuses: +3 on initiative, +4 to strike, +10 to parry and dodge, +4 to roll with impact, +4 to pull punch, +10 save vs magic, +10 save vs poison and disease, and +10 to save vs horror factor.

O.C.C. Skills of Note: Has the following skills at 98%. All Trade Languages of the Three Galaxies, Dragonese/Elven, and a half dozen more from different worlds, plus demon and monster lore, detect ambush, escape artist, prowl, streetwise, tracking, and wilderness survival.

Alliances and Allies: Thraxus has extensive contacts with Naruni Enterprises and other corporations of the Three Galaxies. It is believed that some of his fellow "dungeon-crawlers" are now powerful magicians, rulers of entire planets, and other influential people who he can call upon for favors, and have them or their agents lend him a helping hand.

Minions: Thraxus' current stable of bodyguards include: A horned dragon hatchling called Saburo (5th level); a tattooed man going by the name Doodles (8th level), Total Eclipse, a silhouette sorcerer (9th level), and Crimson, a kreeghor renegade (7th level). Additionally, Thraxus has a personal army of at least 500 soldiers of different races, equipped with the best Naruni Enterprises weapons and equipment.

Transportation: He has enough money to buy or rent a fleet of any known vehicles.

Weapons and Equipment: Thraxus' old "dungeon crawling" days and later purchases have netted him an impressive arsenal of magical and technological weapons. These include half a dozen greatest rune weapons, two dozen greater rune weapons, and nearly a hundred magical weapons of all types from over a hundred different dimensions. Among these weapons are artifacts able to inflict 2D6×10 M.D. per attack and create force fields with 1,000 M.D.C.! Thraxus always wears a half dozen rings as well as earrings, necklaces and armbands. These magical jewels make Thraxus invulnerable to magic, most energy attacks, and psionics, as well as allow him to teleport to a safe haven when needed (equal to the superior teleport spell). This magical arsenal, coupled with his personal powers and allies, makes him almost impossible to capture or kill.

Money: Thraxus has liquid assets (cash) amounting to over 100 trillion credits. His other holdings and properties are probably worth between fifty and a hundred times as much! This is more money than the entire gross national product of any individual planet.

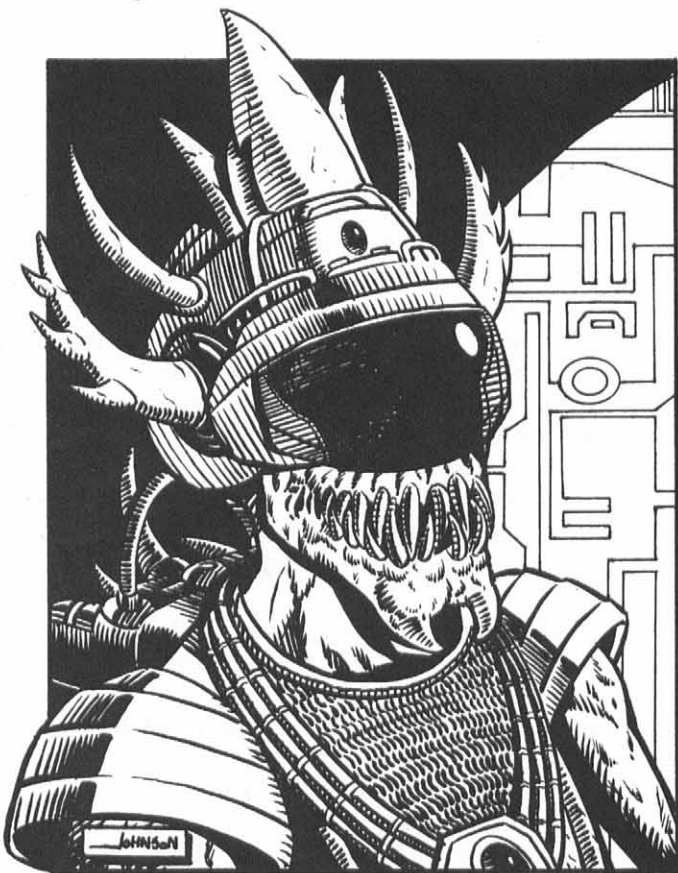

Anshurr

The Eye of Klynncryth

Anshurr is a Splugorth High Lord (see *Rifts Atlantis*) and Lord Klynncryth's right-hand man. He is the Splugorth's chief of intelligence and counter-espionage, a job that has earned him the nickname "The Eye of Klynncryth." Through the use of magic, informants, secret agents and the best surveillance systems available to the Splugorth, Anshurr knows almost everything worth knowing in both Center and much of the Three Galaxies. Through his information network, he has carved out a nice little

empire of his own, and he is not above selling information to the highest bidder, as long as that information does not harm the interests of his master. Anshurr knows very well where his true loyalties must lie if he wants to survive. Lord Klynncryth knows of Anshurr's "extracurricular activities" and approves, as long as the High Lord remembers his place. So far, this has always been the case.

Unlike many High Lords, Anshurr is not prejudiced against humanoids. He sees them as very valuable and useful slaves and servants. Many of his favorite agents include humans, renegade Atlanteans, elves and other "lesser races." The High Lord has been involved in a private war with Thraxus for some time now. The Splugorth and Naruni Enterprises are ancient enemies and any representative of that company is a danger to be neutralized.

Alignment: Diabolic

Attributes: I.Q. 22, M.E. 20, M.A. 11, P.S. 32, P.P. 21, P.E. 18, P.B. 3, Spd. 24. Supernatural strength and endurance.

M.D.C.: 300

Horror Factor: 14

P.P.E.: 300

O.C.C.: High Lord

Level of Experience: 10th

Natural Abilities: Nightvision 1000 ft (305 m), excellent color vision, turn invisible at will, see the invisible, bio-regenerate 1D4×10 M.D.C. per minute, and dimensional teleport 98% to his master only, as often as once every 24 hours.

Disposition: Anshurr is a master of understated intimidation. He rarely threatens victims directly or loses his temper. Instead, he quietly shows them what he will do to them if they don't cooperate. In an emotionless, almost bored tone, he will describe the most horrible tortures imaginable. When dealing with underlings, he also remains calm and self-controlled, but he does not tolerate failure, and death is the least of an unsuccessful minion's worries.

Psionic Powers: Major psionic. Astral projection, empathy, mind block, object read, sense magic, speed reading, telepathy and total recall, all equal to a 10th level psychic.

I.S.P.: 60

Magical Knowledge: Knows all spells and ritual knowledge from levels 1-13, plus all stone master powers, the power to create magic tattoos, and bio-wizardry.

Combat abilities: Natural

Attacks Per Melee Round: Five physical attacks per melee or two by magic.

Bonuses: +1 on initiative, +4 to strike, +4 to parry and dodge, +2 to roll/pull punch, +2 save vs magic, +1 save vs poison and disease, +8 to save vs horror factor.

Vulnerabilities/Penalties: Takes double damage from certain holy and magic weapons.

O.C.C. Skills of Note: Biology, astronomy, chemistry, pathology, holistic medicine, basic and advanced math, computer operation, radio: basic and scrambler, and intelligence, all at 98%. Languages: Dragonese/Elf, Faerie, Gobblely, American, Trade One through Six, and Atlantean, all at 98%.

Alliances and Allies: As Klynncryth's second in command, Anshurr commands a great deal of respect from other evil beings. His closest friend is a Raksasha demon called Zabranas.

Minions: Anshurr has a small army of spies, bodyguards and

special agents. Also, he can command Sector 3-A's security forces, which include several thousand kittani and kyidian warriors as well as tattooed men, metzla monsters, and other powerful minions and slaves.

Weapons: Owns a lesser rune sword (5D6 M.D.) with all the usual powers, a psi-interrogator, and a staff of pacification (see **Rifts Atlantis**).

Body Armor: Standard High Lord armor (100 M.D.C.)

Money: Can get his hands on 1D4×100 million credits at a moment's notice and can make special requests from Lord Klynncryth for more funds.

Trader Smythers

Naruni Enterprises

Smythers is a member of the Uteni race (see **Rifts Mercenaries**), and one of the major members of Naruni Enterprises. This important trader is in charge of the entire Free Trade Zone, which makes him one of the most prominent citizens of Center. A masterful administrator and businessman, Smythers has kept Naruni Enterprises running smoothly in this important part of the Megaverse. The only problems he has are usually related to Thraxus, whom he does not trust, and the Splugorth, who are always trying to subtly undermine Naruni Enterprises (and vice versa).

Besides being in charge of Naruni's "above-board" dealings, Smythers controls a large segment of the Black Market in Center, and other parts of the Megaverse. Some weapon systems that are illegal even in Phase World, such as chemical and bacteriological weapons, are sold through underworld contacts. To that effect, Smythers has had dealings with the *Society of the Knife* and other criminals and smugglers. Although it would appear that these illegal dealings are made privately by Smythers, they are actually a regular part of Naruni Enterprises' business practices. The corporation must sell its products and does not care which markets it approaches to do so. Should the illegal weapon traffic be discovered, the corporation would claim ignorance and the blame would fall squarely upon Smythers.

Trader Smythers and Thraxus do not like each other. Thraxus is a constant source of problems on the Naruni Board of Directors, where he constantly engages in power plays that are disruptive and benefit no one. Once, Smythers tried to have Thraxus quietly assassinated. His team of killers got mailed back to him — in several small packages. Although Thraxus did not retaliate, Smythers is terribly afraid of the magnate and would do almost anything to have him eliminated.

Alignment: Aberrant

Attributes: I.Q. 20, M.E. 15, M.A. 23, P.S. 12, P.P. 15, P.E. 16, P.B. 18, Spd. 11.

M.D.C.: By armor or force field only.

S.D.C./Hit Points: 243 S.D.C. and 51 Hit Points

Horror Factor: None

P.P.E.: 20

O.C.C.: Alien Merchant

Level of Experience: 10th

Natural Abilities: Limited shape-changing. The Uteni's natural appearance is that of a hairless, light-blue biped, about eight feet (2.4 m) tall, with thin and spindly limbs, large eyes, and

no mouth or nose (they breathe through their skins). They can, however, alter their size and features to those of any biped from four to nine feet (1.2 to 2.7 m) tall (their weight remains the same). They cannot simulate body hair and their skin color always remains the same blue.

Disposition: Smythers has the disposition of a used-car salesman. He'll be your buddy as long as you have something he wants, or when he's trying to sell you something. He can only be trusted for as long as it is in his best interest to keep his word. If a better offer comes along, he will turn his back on his own parents or even sell them (rumor has it that he sold all his siblings to slave traders, back when he was a youngster).

Psionic Powers: Clairvoyance, mind block and see aura.

I.S.P.: 86

Magical Knowledge: None

Combat abilities: Hand to Hand: Basic

Attacks Per Melee Round: Four

Bonuses: +1 to strike, +2 to parry and dodge, +4 to roll/pull punch, and +3 to save vs horror factor.

O.C.C. Skills of Note: Computer hacking 98%, computer programming 98%, galactic lore 98%, demon and monster lore 98%, and speaks all trade languages and a dozen other languages of the Three Galaxies. W.P. energy pistol and energy rifle.

Alliances and Allies: Trader Smythers has the full support of Naruni Enterprises and is loosely affiliated with the Society of the Knife and other criminals.

Minions: Has a personal bodyguard made up of kreeghor renegades that are fanatically loyal to him.

Weapons: Several handguns (all manufactured by N.E., of course).

Body Armor: Personal Force Field (130 M.D.C.)

Money: Has a personal fortune of 900 million credits and has trillions of credits at his disposal through Naruni Enterprises.

The Knife Master

Leader of the Society of the Knife

The Society of the Knife is an underground organization that controls a number of illegal activities in Center. It combines elements from the Thieves' Guild, an assassin cult, the Mob, and the black market. Members swear never to reveal any of the secrets about the society, and betrayal is repaid with death. The society has become a major force in the city's politics. The security forces of Center are aware of the society's activities and they often try to stop them, but they have only managed to capture or kill a few low-ranking society members and barely put a dent in its operations.

The Knife Master is the leader of the society. It is not known if he actually founded the organization or if he rose through the ranks to his current position. Very few people know what he looks like, only that he appears to be human. Some rumors claim that the Knife Master is actually several different people. During meetings of the society, the Knife Master often wears a mask. Only the members of the society's inner circle have actually seen his face.



The truth is far different. The Knife Master is one person, a native of the alien dimension of **Wormwood** who found himself in Phase World while escaping the local authorities. While fighting for his life on Level Ten, he was contacted by an alien intelligence that lives hidden there. The intelligence and the refugee made a pact, trading power for servitude. With his new powers, the former warrior was able to form his own criminal gang. A gang that slowly increased in power until it became the Society of the Knife. For several centuries, the Knife Master has been the pawn of this alien intelligence, creating a powerful criminal network that may one day be used for darker purposes.

None of the society's members know the Knife Master's true origins or of his affiliation with the alien intelligence. However, a few suspect he is more than he seems. His fighting skills are uncanny. In his previous life, he was a powerful freelance warrior, and his title is more than an honorific. The Knife Master has often executed an accused traitor himself. Sometimes these executions have taken place in crude arenas, with the condemned been given a hand weapon of his choice, to make things "sporting." The Knife Master has never lost these matches.

Real Name: Arno the Freelancer

Alignment: Diabolic

Attributes: I.Q. 13, M.E. 11, M.A. 18, P.S. 35, P.P. 27, P.E. 20, P.B. 9, Spd. 24.

M.D.C.: 248

Horror Factor: None, unless his true nature is discovered (8).

P.P.E.: 18

O.C.C.: Former freelancer O.C.C. (see **Rifts Dimension Book One: Wormwood**), now a witch (see **Rifts Conversion Book One**).

Level of Experience: 8th level freelancer and 6th level witch.

Natural Abilities: The Gift of Power: Increased physical prowess and physical structure, supernatural strength, and bio-

generate 1D4×10 M.D.C. per hour. As a native of Wormwood, he is naturally an M.D.C. being.

Disposition: Before making a pact with an evil entity, Arno was a warrior who only cared about saving his own skin (miscreant alignment). The pact has made him an angry, embittered man who knows he is a pawn of a greater power. He takes out his frustrations on those around him, getting some small comfort from the fear and misery he causes others. He is a ruthless but efficient businessman and leader who does not tolerate disobedience or insolence.

Psionic Powers: None

Magical Knowledge: None

Combat abilities: Hand to Hand: Assassin (8th level) plus boxing.

Attacks Per Melee Round: Five hand to hand attacks per melee.

Bonuses: +2 on initiative, +8 to strike, +12 to parry and dodge, +7 to roll with impact or to pull punch, +5 to save vs magic, +3 save vs poison and disease, and +6 to save vs horror factor.

O.C.C. Skills of Note: W.P. knife, W.P. sword, speaks American, Trade Three, Trade Four and Trade Six, all at 98%, and Demongogian at 80%. Plus he knows demon and monster lore 75%, prowl 70%, and streetwise 57%.

Alliances and Allies: The Knife Master has an arrangement with Naruni Enterprises, through Trader Smythers. Smythers provides the society with illegal weapons and some assistance, in return for the society's support. Additionally, a number of supernatural creatures on levels Nine and Ten serve the alien intelligence that controls the Knife Master. These creatures might come to his aid in an emergency or to avenge his death.

Minions: The Society of the Knife has over 50,000 full-time members and five times as many "hired muscle."

Weapons: Favors a magical knife (3D6 M.D. plus hand to hand damage that returns when thrown). Also commonly carries an NE-4 plasma cartridge pistol.

Body Armor: Wormwood chain mail (40 M.D.C.) plus a Naruni Force Field (110 M.D.C.)

Money: Millions (perhaps billions) of credits are at his disposal.

The Promethean R.C.C.

The prometheans are an ancient and mysterious race. Their large size and stone-like hides gives them a brutish, intimidating appearance. Looks can be deceiving, however, and prometheans have one of the highest I.Q. averages in the Three Galaxies, surpassed only by the telepathic noro race. More importantly, these massive humanoids are the only race that has mastered phase technology, and are the only sentient race that can "step out of phase" naturally, without the use of technology.

Prometheans have two stages of development. First Stage prometheans are what most people think of when they talk about the members of the race: big, blocky humanoids with enormous intelligence and strange powers. However, these are only immature individuals, little more than children from the perspective of their elders. Second stage prometheans are giants, averaging

over 30 feet (9.1 m) tall. They are rarely seen in public and never outside the planet of Phase World. Their way of thinking is completely alien to most races — it is believed that they are able to project their consciousness into several universes at the same time, and that they are in communication with four or five dimensional beings at any given moment. Nobody seems to know what their goals are. A few people have started cults that either worship the second stage prometheans as gods, or damn them as demons. The prometheans ignore both the worshippers and the persecutors.

Nobody knows for sure how long prometheans live. There are no recorded cases of a second stage promethean dying from old age in the known history of the Three Galaxies. Many believe that prometheans are true immortals, vulnerable only to accidents and violence. Others think that the creatures are very long-lived but they die off eventually — otherwise, the prometheans would have overrun the entire universe long ago. Since the second stage prometheans volunteer no information about themselves, none of these rumors can be proved.

First Stage Promethean

Optional Player Character

First Stage Prometheans are large humanoids (7 to 10 feet/2.1 to 3.0 m tall) with barrel-shaped chests, thick limbs and round heads. Their grayish purple skins are coarse, with the consistency and hardness of stone. Their mouths are little more than thin slits and their eyes are solid black beads. Prometheans have no noses, and don't need to breath. They draw air through their mouths only to speak. They can survive in the vacuum of space unaided by any breathing apparatus or vaccum suit and are invulnerable to most environmental hazards, including radiation and toxic fumes.

The "immature" prometheans are actually as intelligent as the adults of most sentient races. They are roughly human-size and appear to have no genders as we understand them. They don't know much about their second stage elders, but instead of trying to understand what they will become, they seek to learn as much as they can about the rest of the universe. First Stage Prometheans are expected to experience as many different situations as they can before moving on to the next stage of their existence. Thus, first stagers are often found throughout the Three Galaxies as pilots, explorers, travelers, tourists and adventurers. A few even engage in criminal activities like smuggling, piracy or worse. Their personalities are very human-like and go the whole range, from dead serious to clownish, from compassionate to savage and vindictive. Unlike humans, however, prometheans consider all their behavior as part of their discovery process. As they grow older, a formerly evil promethean may see the error of his way and change completely. For this reason, they will almost never kill any member of their race, no matter how evil, because in their view, there is always a chance for redemption. All prometheans who are ready to enter the second stage are principled or scrupulous in alignment.

Prometheans become eligible to enter the second stage of development after reaching 10th level and attaining the appropriate good alignment. To do so, they must pass a test to determine their maturity. This test will almost always involve a quest of some sort, either somewhere in the Three Galaxies or some place

in the Megaverse. Many of these tests are dangerous and may have important consequences for other people. In some cases, the test has involved saving an entire planet from a plague, an invasion, or some other disaster. Prometheans undergoing the test can secure help from other beings, including younger prometheans. An adventure or even a campaign could revolve around a group of player characters trying to help a promethean pass a Test of Maturity.

Some refuse to take the test. There is no stigma attached to the desire to stay at the first stage of development and other prometheans will usually respect their brethren's desires. In any case, the character can always change his mind at any point in the future. The elders make the assumption that if a young promethean does not want to go on to the next stage, he is simply not ready for it and should wait till the time is right.

Alignment: Any

Attributes: I.Q. 3D6+10, M.E. 3D4+10, M.A. 3D4+10, P.S. 4D6+10, P.P. 3D6, P.E. 3D6+12, P.B. 2D4, Spd. 3D6; supernatural beings.

Size: 7 to 10 feet tall (2.1 to 3.0 m).

Weight: 300 to 800 lbs (136 to 362 kg).

M.D.C.: None, but see natural abilities.

S.D.C./Hit Points: 1D6×100 S.D.C. and P.E.×5 hit points. Add 2D6 hit points per level of experience. Also, the prometheans' unique phase powers protects them from most M.D.C. attacks: M.D. attacks inflict only *one S.D.C. point per M.D. point!!* S.D.C. weapons do half damage.

Horror Factor: 10

P.P.E.: 3D6×10

Average Life Span: Unknown. At least several thousand years.

Natural Abilities: Doesn't breathe air and are immune to radiation and normal heat, fire, cold, gases and disease. Can see in total darkness and have eagle-like normal vision.

Phased bodies: Prometheans are in a permanent state of "phase." This means the energies of most weapons are harmlessly dispersed as they pass through their bodies. This dispersal is directly proportional to the energy of the weapon. Hurting a promethean is equally easy (or hard) with an archaic S.D.C. sword as an M.D. laser. Mega-damage attacks from any source inflict only one S.D.C. point per M.D. point rolled. Meanwhile, S.D.C. weapons do half damage.

Phase Teleportation: Prometheans can "step out of phase" and travel at incredible speeds in an intangible state. This is the equivalent of teleportation, because a phased character can only travel in a straight line and for only a second or two. Concentration takes one melee round and is the only action that can be performed during that round. Range: One mile (1.6 km) per level of experience. Chance of Success: 50% plus 4% per level of experience. A failed roll means the teleport does not occur. Passengers, vehicles and large amounts of equipment cannot be teleported along with the promethean.

Sense Dimensional Anomalies: Can automatically detect Rifts, dimensional envelopes and pockets, fourth-dimensional and two-dimensional beings, astral travelers and the invisible energy essence of alien intelligences and entities. Range: One mile (1.6 km) or line of sight, whichever is less.

Ley Line Phasing: Equal to the ley line walker ability.

Experience Level: 1-15; average 1D6+1

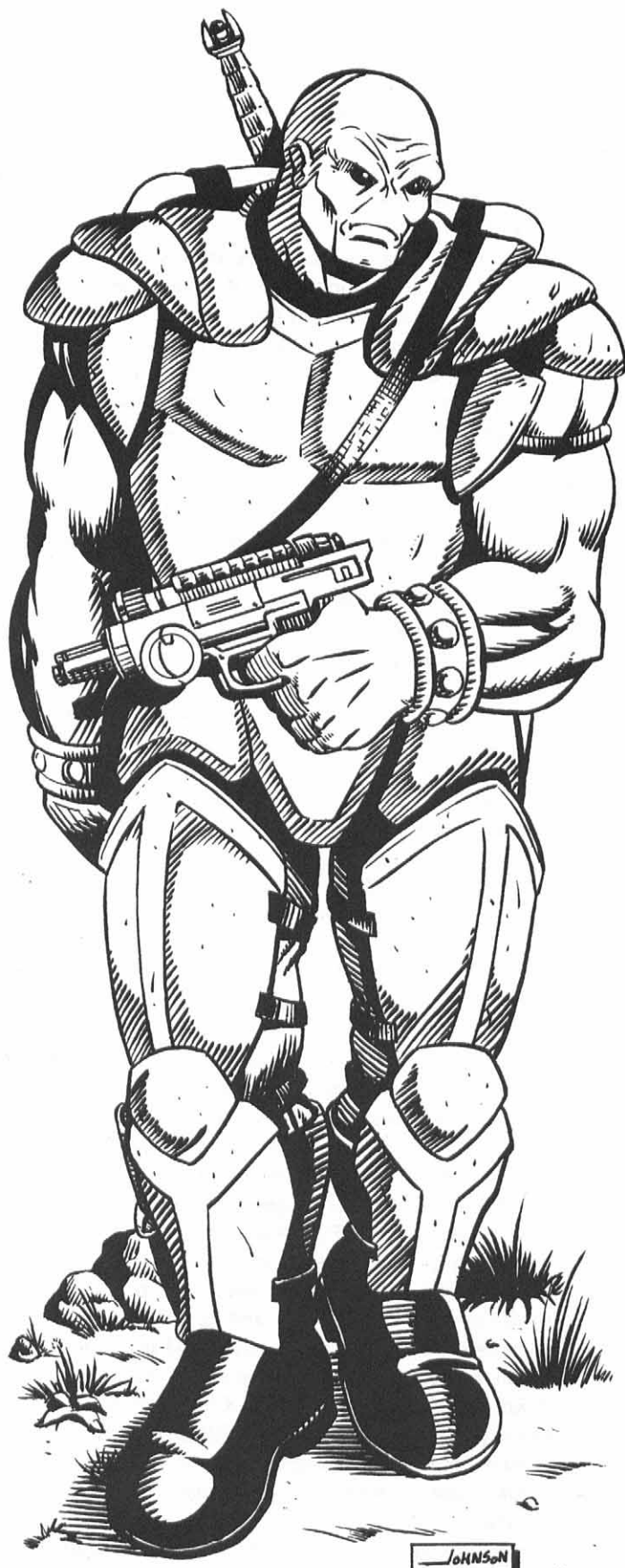

Psionic Powers: Empathy, telepathy, total recall and mind block autodefense are automatic to all prometheans. Plus any three powers from the healing, sensitive or physical categories. Add one more power from any of these three categories every level after the first.

I.S.P.: M.E.x5, plus 10 per level of experience. Considered a master psionic.

Magic Powers: Varies. Some prometheans pursue temporal magic, becoming either temporal wizards (see **Rifts England**) or time masters (elsewhere in this section), but most of them disdain the study of magic. **Special:** Prometheans can choose Temporal Magic spells (but no other normal spells) instead of R.C.C. related or secondary skills! No more than four spells can be selected in this way. Only about 5% of all First Stage Prometheans bother learning spells and only 1% dedicate themselves full-time to the pursuit of magic. See the Promethean Time Master O.C.C.

Phase Powers: Prometheans can also study and deepen their knowledge of phase powers, which is what many do. Each phase power learned in this way counts as an "other" or secondary skill, just as spells (see above). Up to four phase powers can be learned in this way, but no more powers can be learned or purchased past this point. Also see the *Promethean Phase Adept R.C.C.* **Note:** Both temporal spells and phase powers can be learned, but they cannot "total" more than four, not four of each.

Damage: Prometheans have supernatural strength, and inflict mega-damage with their punches and kicks. See **Rifts Conversion Book One**, page 22, to calculate damage.

Bonuses: +1 on initiative, +6 to save vs magic, +3 to save vs psionics, +6 to save vs horror factor. All these are in addition to attribute and skill bonuses.

Vulnerabilities/Penalties: Phase-tech weapons inflict double damage and magic does full damage.

R.C.C. Skills:

Language and literacy: Promethean 98%

Language and literacy: Trade Two 98%

Two languages of choice (+25%)

Basic Math (+20%)

Advanced Math (+20%)

Hand to Hand: Basic

Hand to Hand: Basic can be changed to expert at the cost of one "other" skill or martial arts or assassin at the cost of two "other" skills.

R.C.C. Related Skills: Select 14 other skills. Up to four "other" skills can be taken as temporal magic spells or phase powers instead of conventional skills. Plus, select two additional skills at level three, two at level six, and one at levels nine, twelve and fourteen. All new skills start at level one proficiency.

Communications: Any (+5%)

Domestic: Any

Electrical: Any (+10%)

Espionage: Any (+10%)

Mechanical: Any (+10%)

Medical: Any (+5%)

Military: Any (+5%)

Physical: Any except acrobatics.

Pilot: Any (+10%)

Pilot Related: Any (+5%)

Rogue: Any (+10%)

Science: Any (+15%)

Technical: Any (+10%)

W.P.: Any

Wilderness: Any

Secondary Skills: The character also gets to select eight secondary skills from the previous list. These are additional areas of knowledge that do not get the advantage of the bonus listed in parentheses.

Alliances and Allies: Prometheans work closely with members of the draconid race. They are also well regarded by the Consortium of Civilized Worlds, the largest civilization in the Three Galaxies. The cosmo-knights respect all prometheans, although they will not hesitate to stop an evil or dangerous member of the race. Prometheans are persecuted in the Transgalactic Empire and are hated or feared in many areas of the Three Galaxies and other dimensions.

Weapons: Favor phase-tech weapons, but can use any equipment available.

Body Armor: Warrior-types favor segmented armor manufactured on Phase World (120 M.D.C.); for an extra cost, the armor can have a phase field.

Equipment: 2D6×10,000 credits in equipment or weapons, plus 1D6×1000 credits in cash or trade items.

Promethean Phase Adept O.C.C.

Optional Player Character

The phase adepts are first stage prometheans who have dedicated themselves to the mastery of phase powers for the protection of their race. They are the equivalent of mystic warriors who have developed an arsenal of exotic powers using their phase abilities. They can walk through walls, make their bodies intangible, alter the weight and momentum of objects, and teleport in combat. Their teachings include a strict code of honor, and an oath to protect Phase World and other worlds from invaders and despoilers.

Most adepts are on Phase World, guarding key installations and enforcing the law at Center (at least in the areas that remain under the prometheans' control). At some point, however, all adepts are expected to leave Phase World for some time (from decades to centuries) and travel through the Three Galaxies and/or the Megaverse to learn more about the universe at large, and their place in it. Those on such furloughs usually act as law enforcers, bodyguards or crusaders. They are one of the few beings that often work alongside cosmo-knights to battle threats on a cosmic level.

Alignment: Usually scrupulous or principled. A few renegades are diabolic or aberrant, and are feared throughout the galaxies.

Attribute Requirements: I.Q. 17 and M.E. 17.

O.C.C. Abilities and Bonuses: In addition to the normal powers of all prometheans (see above), the phase adept learns a variety of powers.

1. Attribute and Combat Bonuses: Due to their intense physical training, they get +3D6×10 S.D.C., +1D6 to P.S., and +1D4 to P.P. They also have one extra attack per melee, and +2 to initiative.

2. Phase Powers: At level one, the adepts can take six phase powers from the list found at the end of this section. Plus they select another phase power at each additional level of experience.

3. Psionic Powers: In addition to the normal psionic powers available to all prometheans, phase adepts select one superpsionic power at level one (excluding psi-sword, which cannot be learned until third level), and one power from any category for each additional level of experience.

4. Magical Resistance: Phase adepts learn to focus their minds to generate a low-level phase field around them that *nullifies* magic energies. Any spell that directly targets a phase adept is negated! Spells that create energies that attack the target (call lightning, fireball, etc.) are not affected by the field and inflict full damage, as do rune weapons and other types of magic weapons. This power costs 5 I.S.P. per spell that is negated.

5. I.S.P.: Phase Adepts use I.S.P. to fuel both phase and psionic powers. To calculate their I.S.P., roll 1D4×100 and add the M.E. attribute. They get an additional 15 I.S.P. per level of experience.

O.C.C. Skills:

Language and literacy: Promethean 98%

Language and literacy: Trade Two 98%

Two languages of choice (+25%)

Basic Math (+20%)

Advanced Math (+20%)

Galactic Lore (+15%)

Pilot: Small Spacecraft (+20%)

Pilot: Any two (+15%)

Prowl (+15%)

Detect Ambush (+20%)

W.P. Sword

W.P. Energy Pistol

W.P. Energy Rifle

Hand to Hand: Martial Arts

O.C.C. Related Skills: Select six other skills, plus two additional skills at levels four, seven, nine and twelve.

Communication: Any (+5%)

Domestic: Any

Electrical: Any

Espionage: Any (+10%)

Mechanical: Any

Medical: First aid or paramedic only (+10%)

Military: Any (+5%)

Physical: Any (+5% where applicable)

Pilot: Any (+5%)

Pilot Related: Any (+10%)

Rogue: Any (+5%)

Science: Any

Technical: Any (+10%)

W.P.: Any

Wilderness: Any (+5%)

Secondary Skills: The character gets to select four secondary skills from those listed. These are additional areas of knowledge that do not get the advantage of the bonus listed in the parentheses. All secondary skills start at the base skill level.

Standard Equipment: Steelcloth loose-fitting robes (A.R. 12, 90 M.D.C.), a suit of heavy environmental body armor (150 M.D.C.), phase beamer and one heavy energy weapon of

choice, computer chip with audiovisual meditation aids, phase-tech first aid-kit, and emergency rations for 1D4 weeks.

Money: 2D6×1000 in credit or trade items.

Cybernetics: None. Phase Adepts never use cybernetics.



Promethean Time Master O.C.C.

Optional Player Character

A small percentage of the Promethean race (about 1%) dedicate themselves fully to the study of temporal magic. These mages are greatly respected throughout the Three Galaxies and many places of the Megaverse. Their control over sorcery coupled with their natural phase powers makes them dangerous enemies. Half of these mages are temporal wizards as described in **Rifts England**. The other half are time masters. The time masters are adventurers and explorers who try to discover the innermost secrets of the universe.

According to several legends, the prometheans learned temporal magic from fourth-dimensional beings like the mysterious god Zurvan (see **Pantheons of the Megaverse**). In any case, promethean time masters do not learn spells like the temporal wizard or warrior. Instead, they undergo rituals of advancement in a way similar to a mystic or warlock. Some occultists believe that the time masters are the equivalent of a warlock, but a warlock that concentrates on the "element" of time. This link to the timestream does take a toll on the character's sanity, but it is not as extreme as the effects on "traditional" temporal wizards and warriors.

So far no member of another race has learned to establish a mystic link with the timestream. Only prometheans can become time masters, and they cannot teach their spells to wizards. Only the few that become true temporal wizards and warriors can act as teachers of temporal magic.

Attribute Requirements: I.Q. and M.E. 12 or higher.

O.C.C. Abilities and Bonuses:

Promethean time masters have all the normal abilities of their race, plus:

- 1. Spell Magic:** At first level, time masters learn two temporal magic spells of choice. Additionally, they can select two regular magical spells from levels 1-3. At each level of experience, the time master must enter a meditative trance in which he is transported to a transdimensional realm where time and space are warped beyond recognition. By communing with this chaotic dimension, the character gains one temporal magic spell and one normal magic spell of the same or lower level as the character.
- 2. P.P.E.:** The time master has 3D6×10+100 plus the P.E. attribute and gains 10 points per each additional level of experience.
- 3. Insanities:** Roll once on either the phobia or obsession tables (see **Rifts**, page 20) to determine the insanity (G.M.'s choice or he can let the player decide).

O.C.C. Skills:

Language and literacy: Promethean 98%

Language and literacy: Trade Two 98%

Two languages of choice (+25%)

Demon and monster lore (+15%)

Basic Math (+20%)

Advanced Math (+20%)

Piloting (any one) (+10%)

W.P.: Energy Pistol

Hand to Hand: Basic

Hand to Hand: Basic can be converted to expert at the cost of one "other" skill or to martial arts at the cost of two "other" skills.

O.C.C. Related Skills: Select 6 other skills. Plus, select one additional skill at levels three, seven and twelve. All new skills start at level one proficiency.

Communications: Any (+5%)

Domestic: Any

Electrical: Any

Espionage: Any

Mechanical: Any

Medical: Any

Military: None

Physical: Any except acrobatics.

Pilot: Any (+10%)

Pilot Related: Any (+5%)

Rogue: Any (+5%)

Science: Any (+5%)

Technical: Any (+10%)

W.P.: Any

Wilderness: Any (+5%)

Secondary Skills: The character also gets to select six secondary skills from the previous list. These are additional areas of knowledge that do not get the advantage of the bonus listed in parentheses.

Standard Equipment: One phase weapon of choice, one energy weapon, 1D6 E-cells, hand computer, cloak and hood, and knapsack.

Money: 2D6×1000 credits

Cybernetics: Never get any.

Phase Mystic O.C.C.

Optional Player Character

A few worthy *non-prometheans* with great psionic potential are sometimes accepted as pupils by the phase adepts. This tiny elite group of beings are the only creatures besides the promethean race to have some degree of control over phase powers. Their control over phase abilities is not as extensive or great as that of true phase adepts and they lack many of the special powers of the promethean race. Phase mystics are often feared, because even their limited phase abilities make them fearsome enemies.

Phase mystics undergo similar training and initiation rituals to those of phase adepts. They are expected to follow the same code of honor and strict morality, and to champion the cause of good wherever they go. Sometimes phase mystics have turned against their former teachers and become powerful criminals and conquerors. This is one reason why so few beings are ever taught the secrets of phase powers.

The lucky few who learn these secrets usually become dedicated enemies of evil, joining forces with cosmo-knights and other champions. Others remove themselves from human concerns, concentrating only on mastering their powers. Despite their knowledge, phase mystics are as baffled by phase technology as anybody else.

Attribute Requirements: I.Q. and M.E. 15 or higher. High physical attributes are desirable but not necessary.

Alignment: Most phase mystics are of good alignment. A few are unprincipled and only a small percentage are anarchist or evil.

Races: Phase mystics come only from a few races. Most mystics are human, draconid, wolfen, seljuk and noro. Once a kreeghor may have become a phase mystic, but his existence is lost to legends and myths.

O.C.C. Abilities and Bonuses:

- 1. Bonuses:** Due to their intense physical training, phase mystics have +1 to P.S. and P.P., +3D6 S.D.C. (or M.D.C. if an M.D.C. being to begin with) and are +2 to initiative.
- 2. Phase Powers:** Phase mystics can select four phase powers at level one. Plus they get to select an additional power at each additional level of experience.
- 3. Psionic Powers:** At level one, the phase mystic can select three psionic powers from the healing, sensitive or physical categories, and one super-psionic power (excluding psi-sword, which cannot be learned until third level). One power from any one category can be selected for each additional level of experience. They are considered to be master psionics.
- 4. Magical Resistance:** Phase mystics learn to focus their minds to generate a low level phase field around them that nullifies

magic energies. Any spell that directly targets a phase mystic is negated. Spells that create energies that attack the target (call lightning, fireball, etc.) are not affected by the field and inflict full damage. Likewise, rune and other magic weapons do full damage. This power costs 5 I.S.P. per spell negated.

- 5. I.S.P.:** Phase mystics use I.S.P. to fuel both phase and psionic powers. To calculate their I.S.P., roll 2D6×10 and add the M.E. attribute. They get an additional 10 I.S.P. per level of experience.

O.C.C. Skills:

Language and literacy: Promethean at 98%

Language and literacy: Native Language at 98%

Three languages of choice (+20%)

Basic Math (+20%)

Advanced Math (+10%)

Galactic Lore (+10%)

Pilot: Small Spacecraft (+15%)

Pilot: Any two (+10%)

Prowl (+10%)

Detect Ambush (+20%)

W.P. Sword

W.P. Energy Pistol

W.P. Energy Rifle

Hand to Hand: Expert

Hand to Hand: Expert can be converted to martial arts at the cost of one "other" skill.

- O.C.C. Related Skills:** Select six other skills, plus two additional skills at levels four, seven, nine and twelve.

Communication: Any (+5%)

Domestic: Any

Electrical: Any

Espionage: Any (+10%)

Mechanical: Any

Medical: First aid or paramedic only (+10%)

Military: Any (+5%)

Physical: Any (+5% where applicable)

Pilot: Any (+5%)

Pilot Related: Any (+5%)

Rogue: Any (+5%)

Science: Any

Technical: Any (+10%)

W.P.: Any

Wilderness: Any

- Secondary Skills:** The character also gets to select six secondary skills from the previous list. These are additional areas of knowledge that do not get the advantage of the bonus listed in parentheses.

Standard Equipment: Steelcloth loose-fitting robes and jumpsuit (A.R. 19, 40 M.D.C.), a suit of heavy environmental body armor appropriate for the race, a phase beamer and one heavy energy weapon of choice, computer chip with audiovisual meditation aids, phase-tech first-aid kit, and emergency rations for 1D4 weeks.

Money: 2D4×1000 credits

Cybernetics: None to start. Only acquired if absolutely necessary, and tend to stick to simple prosthetics and bio-systems. Bionics interferes with magic.



Second Stage Promethean

Non-Player Characters

When a promethean passes the Test of Maturity, he walks into one of the *Initiation Temples* (only six known temples are all in Phase World). Some never come back out. Those that do are transformed physically and mentally. Their old personalities become a fading echo, and are replaced by an alien way of thinking. Second stage prometheans are similar to elementals and other alien beings in that their morality and principles have little in common with those of most sentient races. For instance, the rulers of Phase World permit all kinds of criminal activity to occur in Center, including slavery, drug trafficking, kidnapping and extortion. Only the areas directly under the prometheans' control are free of such activities. Either the second stage prometheans don't care about the fates of the victims who suffer from these crimes or they have chosen not to interfere with them for unknown reasons.

Second stage prometheans are fearsome creatures. They double or triple in size and mass (averaging 15 to 30 feet tall/4.6 to 9 m). Their speed and agility are reduced, but their rock-like bodies become incredibly tough, making them full mega-damage beings. Looking at a second stager for more than a few minutes can be unsettling, as their forms seem to change in subtle ways. Their color starts fluctuating and they often seem to grow or diminish in size and proportions. Occasionally, people can see through their bodies as if they were ghosts. Once in a while they disappear and reappear a short distance away! Most sentients feel uncomfortable in the presence of these beings, another reason they rely on first stage "children" to conduct most diplomatic talks and negotiations.

Second staggers rarely become involved in the affairs of the Megaverse. When they do so, it means that some danger of cosmic significance is at large. They are distrusted and feared by many of the other "great powers" of the Megaverse. The Splugorh hate these beings, but all direct attacks against the Prometheans have failed miserably. Instead, the Splugorh have decided to maintain a facade of diplomacy while trying to subtly sabotage and undermine the giants. So far, this tactic has not succeeded, either. A few gods and supernatural beings are on good terms with the prometheans.

Note: Second stage prometheans are meant to be an NPC race. Their power and alien nature make them unfit as player characters.

Alignment: Unknown. Something between principled and aberrant, depending on the situation.

Attributes: Use a first stage promethean, but add the following extra dice, bonuses or penalties: I.Q. +2, M.E. +2, M.A. +2, P.S. +1D6+6, P.P. -2, P.E. +1, P.B. -1, Spd. -1D6; still supernatural beings.

Size: 15 to 30 feet (4.6 to 9 m) tall.

Weight: 4 to 6 tons (3600 to 5400 kg).

M.D.C.: 4D6×100

Horror Factor: 14

P.P.E.: 2D6×10 in addition to what their First Stage form had.

Average Life Span: Unknown, presumably thousands of years and they may be true immortals (don't die of old age or natural causes).

Natural Abilities: Doesn't breathe air and is immune to radiation and normal heat, fire, cold, gases and disease. Can see in total darkness and has eagle-like normal vision.

Phased bodies: Prometheans are in a permanent state of phase; the energies of most weapons are harmlessly dispersed as they pass through their bodies. Second stage prometheans are totally impervious to S.D.C. weapons and all other attacks do only one-quarter damage! Even magical and psionic attacks are affected by this power and do half damage.

Phase Teleportation: Prometheans can "step out of phase" and travel at incredible speeds in an intangible state. This is the equivalent of teleportation, because a phased character can only travel in a straight line and for only a second or two. Concentration takes one melee round and is the only action that can be performed during that round. Range: 1,000 miles (1600 km). Chance of Success: 88% plus 1% per level of experience.

Dimensional Teleport: Second Stage Prometheans can travel to other dimensions without opening Rifts or using dimensional gates. This power is limited to places/dimensions known by, or previously visited by the character. Chance of Success: 50% plus 5% per level of experience.

Sense Dimensional Anomalies: Can automatically detect Rifts, dimensional envelopes and pockets, fourth-dimensional and two-dimensional beings, astral travelers and the invisible energy essence of alien intelligences and entities. Range: One mile (1.6 km) or line of sight, whichever is less.

Ley Line Phasing: Equal to the ley line walker ability.

Experience Level: A first level second stage promethean has all the skills/bonuses of a 10th level first stage promethean, but start at a new strata of experience (use the dragon experience table starting at level 10 at first level). Average experience level is 1D6+3.

Psionic Powers: Know all sensitive, physical and healing powers. Plus they know four super-psionic powers and learn a new one every level after the first.

I.S.P.: Triple the amount he had as a first stager.

Magic Powers: Only those that were learned as a first stager.

Phase Powers: Know ALL phase powers.

Combat: First Stage abilities at level 10. Doesn't gain any more combat bonuses or expertise in that area regardless of age or level.

Bonuses: +1 on initiative, +6 to save vs magic, +6 to save vs psionics, +6 to save vs horror factor. All these are in addition to attribute and skill bonuses.

R.C.C. Skills: In addition to the skills of a 10th level first-stage promethean, select an additional six "other" skills.

Alliances and Allies: Second stage prometheans are an important force in the Megaverse, but they rarely use their powers to interfere with others. They are on good terms with Zurvan (the Persian god of time) and with the ruler of the Indian Pantheon, Brahma (see **Pantheons of the Megaverse** for these and other gods). They may be involved in the effort to contain a number of powerful evil intelligences such as the Old Ones.

Weapons and armor: Never use any. They rely on their supernatural abilities (psionics, phase powers, attributes, etc.)

Phase Powers™

Phase powers seem to be a variation on psionic abilities. Like psionic powers, they are activated by using I.S.P. Besides prometheans, only the phase mystic O.C.C. can learn these abilities. Phase powers separate the user from normal space-time, allowing him to perform a number of superhuman feats, from teleportation to being in two places at the same time!

G.M. Note: Dealing with Phase Powers

The abilities of the promethean race and their phase powers can be hard to manage in some campaigns. Players whose characters can teleport away from trouble (among other things) may think they can get away with murder (sometimes literally). If the Game Master allows prometheans or phase powers in his campaigns, he should keep the following facts in mind.

1. People in the Three Galaxies are aware of phase powers and technology and have developed a number of countermeasures against them. Force fields are effective barriers against phase adepts because most phase powers (including teleportation) will not work through even the flimsiest force field.

2. Magic is also an important defense. Magic barriers will hinder or stop phase powers. Furthermore, most magic spells and weapons inflict full damage against first stage prometheans and phase mystics; half damage on second stagers.

3. In general, phase powers and phase-characters should be limited to high-powered or "cosmic" campaigns. There are very few of them in the Megaverse and they usually get involved in important quests and adventures from the get-go.

If characters start getting too cocky, equipping their antagonists with magical or technological countermeasures (or even with their own phase adepts!) should deal with that problem. Also remember that there are *always* consequences for one's actions. A phase powered character who abuses his abilities will be hated and feared, which is likely to cause bounty hunters, mercenaries, cosmo-knights, heroes or even other prometheans (first or second stagers) to hunt him down and bring him to justice. Also remember that most people throughout the Megaverse dislike, distrust, and even loathe and despise beings who possess phase powers.

Alphabetical List of Phase Powers

Anti-Phase (30)
Close Rift (200)
D-Phase (15)
D-Shift Distance (20)
D-Shift Ghost (50)
Dimensional Leap (10)
Fast Draw (varies)
Multi-Phase (20)
Phase Blast (15)
Phase Field (25)
Phase Warp: Confuse (20)
Phase Warp: Displacement (25)
Phase Warp: Split Persona (30)
Spacial Distortion: Self (15)
Spacial Distortion: Others (20)

Anti-Phase

Range: 100 ft (30.5 m) plus 20 ft (6.1 m) per level of experience.

Duration: Instant

I.S.P.: 30

This power cancels out any phase ability or field it strikes. This includes technological phase fields, temporal magic spells that involve spacial or time distortions, and any continuing phase powers. Anti-phase only works on ongoing phase effects and will not damage weapons, heal damage caused by phase blasts, or undo something that had already been done by a phase power.

Close Rift

Range: 100 feet (30.5 m)

Duration: Instant

I.S.P.: 200 I.S.P. plus 2 I.S.P. from the character's permanent I.S.P. base!

This power works just like the close Rift magic spell in Rifts, page 189. However, the Rift gets to roll a save against psionic attack (not magic).

D-Phase

Range: Self

Duration: One melee round (15 seconds) per level of experience.

I.S.P.: 15

This power is very similar to the temporal magic spell of the same name, and uses similar principles. The power warps and bends the dimensional aspects of reality to allow the character to walk through solid matter. This requires great concentration. Loss of concentration means a failure to complete phasing though an object, which causes a flash of light and the person goes flying back from where he started, suffering 2D6 hit point damage, feels icy cold to the touch, and is dazed for 1D4 melees (has only one melee attack and has no combat bonuses while dazed). This "pop back" also occurs when the duration time of the power elapses, and the character is still phasing inside an object.

The character may be affected by a lack of air when phasing through a large amount of solid matter, such as thick castle walls, hill or mountain. The character must hold his breath the period of time it takes to phase through the solid object. If his air supply is used up while in phase, he loses concentration and is "popped back" to where he started, with the usual results.

D-Shift Distance

Range: Varies

Duration: Instant

I.S.P.: 20

The phase adept can use this power to twist space. For example, he can make a 20 foot (6.1 m) distance suddenly become a two foot (0.6 m) distance for him, or 200 feet (61 m) for somebody else. Space can be shifted by a factor of 10 (up to ten times larger or one-tenth its normal dimension/distance) for the range of the power. To observers, the character's form will seem to stretch or contract in a totally bizarre way. For example, the character might punch a target 20 feet (6.1 m) away. His arm might seem to stretch across the distance separating the two. Or an enemy about to strike the adept might suddenly see that his target has moved several hundred feet away! Likewise, the char-

acter might have space twist so that a bullet he fires will “curve” its trajectory to hit the target.

Each activation of the power allows one melee attack/action that *twists* space. Speed is basically multiplied by 10 during that melee action. Note that this power does not allow the character to travel through solid objects, so if he is not careful he might crash into a wall at ten times normal speed! Using this power will grant a +10 bonus to strike or dodge but not parry, or any other combat bonuses. This power will not work in areas protected by phase fields.

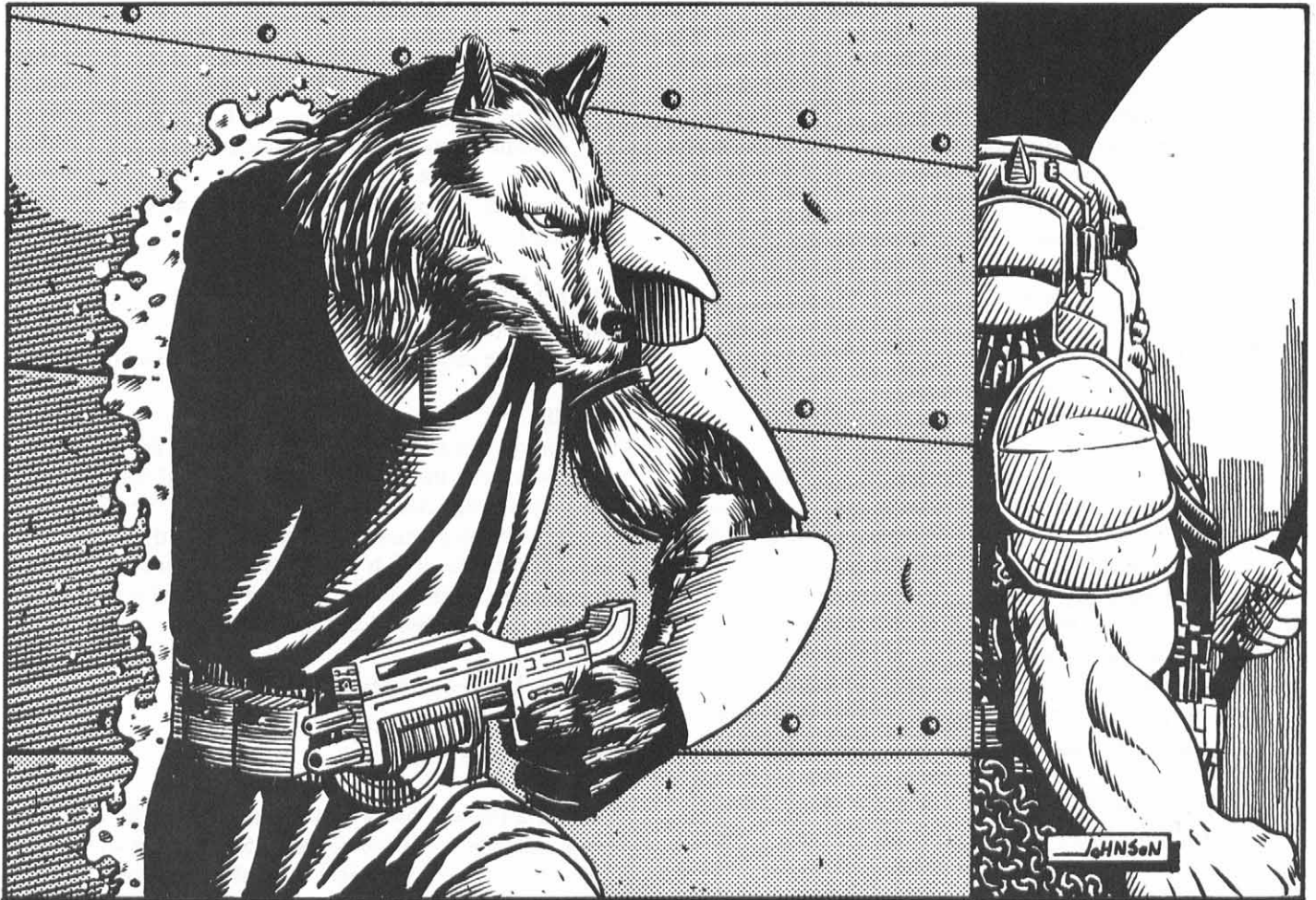

D-Shift Ghost

Range: Self

Duration: One minute (4 melees) per level of experience

I.S.P.: 50

This power removes the character from normal three-dimensional space, rendering him invisible and insubstantial. While in this state, the character can observe things in the three-dimensional world but is completely undetectable by normal means, including the see the invisible spell or powers. During this ghost mode, the character's speed is reduced to 4, but he can move in any direction, including up and down, and is unimpeded by normal barriers (stopped by phase, magic and forcefield barriers). While in this state, the character cannot perform any actions (including using other powers or spells) other than moving around and observing.

Dimensional Leap

Range: Up to 120 ft (37 m)

Duration: Instant

I.S.P.: 10

The character phases out of our space-time continuum and reappears somewhere else. The teleportation process is instantaneous. He disappears in a blink and reappears a second later. It can be used in combat to reappear behind an enemy, avoid an attack, etc. Using this power defensively provides a +6 bonus to dodge. Each leap counts as a melee attack/action and costs 10 I.S.P. to activate. The destination of the leap must be visible to the person teleporting and he cannot carry another person with him.

Fast Draw

Range: Varies

Duration: Instant

I.S.P.: Varies: 4 to 80

This power allows the character to summon an object he has attuned to himself, even over great distances. As a result, a phase adept is never truly unarmed, because he can instantly summon a weapon into his hand. A character can attune one object per level of experience. These objects cannot exceed 100 lbs (45 kg) in weight and are usually weapons or tools. The I.S.P. cost varies with the distance involved. If the object is on the person's body, in a pistol holder or backpack, for instance, it costs 4 I.S.P. to make it appear in the character's hand. If the object is within one mile (1.6 km), it costs 10 I.S.P. The character can summon an attuned object from anywhere on the planet for 20 I.S.P., and for 40 I.S.P., the object can be summoned from anywhere in the galaxy! Bringing an attuned object from another dimension costs 80 I.S.P. and takes one full melee round (15 seconds).

This power will not work if the character or the object in question are surrounded by force fields or magic barriers of any sort, including protection circles.

Multi-Phase

Range: 20 ft (6.1 m) per level of experience.

Duration: One minute (4 melees) per level of experience.

I.S.P.: 20 per duplicate form.

The phase adept creates one or more duplicates of himself by anchoring his form in more than one place in space-time. However, only one of his forms is able to affect the physical world; the others can be seen and heard, but are actually insubstantial projections. Striking a projection will do no damage; attacks will pass harmlessly through them. The character determines where the duplicates will appear, as long as they are within range. The duplicates are perfect mirror images, doing exactly the same thing the "real" physical form is doing at that exact same instant.

Unlike traditional illusions of this type, the character can switch places with any of his duplicates at any time! Switching from one point to another counts as one melee attack/action. If the adept's real form is about to be attacked, this action can be combined with a dodge to "jump" before being hit.

Example: A phase adept creates three duplicates of himself, surrounding a Kreeghor warrior. At first, the adept is facing the kreeghor warrior. On his first melee attack, the character switches with the duplicate behind his enemy and strikes him. The kreeghor whirls around and tries to strike him, but the character dodges the attack by jumping to another duplicate!

Phase weapons, ley line storms, and magic circle will disperse a duplicate. Sense and see dimensional anomalies, detect psionics, see aura, telepathy and empathy will also detect where the real flesh and blood character is standing.

Phase Blast

Range: 100 feet (30.5 m) per level of experience.

Duration: Instant

I.S.P.: 15

The phase adept can produce a blast of disruptive phase waves. This attack does 3D6 S.D.C. or M.D.C. damage depending on the nature of the target. A human being would suffer S.D.C. damage, while a dragon would take mega-damage. This blast ig-

nores conventional armor and goes right through! However, it is stopped by force fields, magic armor, magic barriers (the fields/barriers take full M.D. damage from the blast), spells of protection and circles of protection (the latter simply stops the blast from travelling through the circle; no damage). Phase blasts are +4 to strike, but adding 10 I.S.P. increases the strike bonus to +8 to strike.

Phase Field

Range: Self

Duration: One minute (4 melees) per level of experience.

I.S.P.: 25

This power creates a force field that disperses incoming energy, including bullets fired from rail guns and projectile weapons. Non-magical attacks have their damage divided by 10 before applying the damage to armor or the character. The field is useless against phase weapons, the phase blast power, magic attacks, magic weapons, and punches and kicks (they move too slowly to be affected) — all do full damage.

Phase Warp: Confuse

Range: 90 ft (27.4 m)

Duration: One melee round (15 seconds) per level of the phase adept.

I.S.P.: 20

This power twists space around the victim so that he becomes "out of step" with the physical world. The confused character's body always miscalculates distance and speed, so he is always bumping into things, missing his targets, and tripping over his own feet! If the target fails a save versus psionics, he will be at -6 to strike, parry and dodge, and at -40% to all skills (-60% if the skill requires precise spacial measurements).

Phase Warp: Displacement

Range: 100 feet (30.5 m) per level of experience.

Duration: Instant

I.S.P.: 25

This is a teleport that affects objects and people. The maximum weight affected is 100 pounds (45 kg) at first level plus 50 pounds (22.5 kg) per additional level of experience. The object or individual must be in range, and can be teleported anywhere within that range. Unwilling living beings can save versus psionics to resist this power. Objects cannot be teleported/displaced inside living beings or any solid object (walls, tables, etc.) and people cannot be deliberately displaced into walls, furniture, etc. This spell is strictly a spacial effect, moving an object or person from one location to another within the limited range of the phase user.

Phase Warp: Split Persona

Range: 20 ft (6.1 m) plus 10 ft (3 m) per level of experience.

Duration: One minute (4 melees) per level of experience.

I.S.P.: 30 per limb or body part.

This ability allows the character to "separate" limbs and body parts and cause them to reappear some distance away. This is a spacial distortion and the body parts are still connected to the person. For example, a character could have his gun hand appear 40 feet (12.2 m) ahead of him, right behind the enemy he's facing! He can actually shoot but the character must be able to see

his gun hand to aim and fire (even so he is -3 to strike and -8 if shooting/striking blind or wild).

To an observer, it would seem that the phase adept's hand has been sheared off at the wrist (bone and blood vessels are visible, but there will be no bleeding), and that a disembodied hand has appeared behind his enemy. Other tricks using this power is to send a hand or arm to snatch keys or other small objects, open a door, turn on, or off lights and devices, knock on a door/wall yards away, send one of his eyes into another room where he can observe what is going on (sending in the whole head or both eyes leaves his body defenseless), and so on.

Both the adept and the body parts can be attacked normally, and take normal damage. Small body parts (hands, eyes, heads) require a called shot at -2 to -6 to hit (G.M.'s decision on penalties). If the *anti-phase power* is used successfully against a character using split persona, the character must make a save of 12 or higher (add any P.E. bonuses) or the separated body parts will be severed or wrenched off his body! As usual, the split persona/limb cannot penetrate through phase of magic barriers.

Spacial Distortion: Self

Range: Self

Duration: One minute (4 melee rounds) per level of experience.

I.S.P.: 15

This power creates a phase field that distorts space around the user. Distance and the exact location are "curved" around the

character and to normal observers his form becomes blurred or twisted as in a funhouse mirror. Attacks that travel in straight lines or slight arcs (beam weapons, bullets, arrows, etc.) are at -4 to hit the target due to the distortion. The phase user is also able to take "longer" strides as he walks and runs, increasing his normal speed by 10 times for the duration of the effect.

4-D beings and many temporal magic spells (see **Rifts England**) can detect and neutralize the use of this power.

Spacial Distortion: Others

Range: 20 ft (6.1 m) per level of experience.

Duration: One minute (4 melees) per level of experience.

I.S.P.: 20

Same as the previous spell, except it works on other people. If the subject is not a promethean, phase mystic or temporal wizard or warrior, the distortion effect will also impair his senses giving him the following penalties: -1 on initiative, -2 to strike, parry and dodge, and -15% on all skills (the character's senses are distorted by the field).

Other Races & O.C.C.s of Note Common to Phase World

Draconid R.C.C.

Draconids are false reptilian humanoids. They may look like lizard men, but despite their scaly bodies, they are mammals and bear live children instead of eggs. They have striking similarities to the dragon races. Like dragons, they are creatures of magic with great arcane and psionic powers. Some scholars think the draconids are the result of some wizard or god's experiment that somehow mixed dragons with humans or perhaps Atlanteans. Some of the draconids' creation legends put their race as the "missing link" between humans and dragons. Other scholars believe they are an unrelated species that evolved naturally in some alien dimension.

Draconids are erect humanoids with long reptilian snouts, bat-wing shaped ears and short, almost vestigial tails. They have large canine teeth and clawed hands and feet. In some places they are mistaken for demons (Horror Factor 10). They have no wings and their scales can be green, blue, red, or many shades in between those three colors.

Like their namesakes, draconids have spread through the Megaverse. They are more numerous than true dragons, but are still not very widespread compared to other races. Draconids can be found in small concentrations on Rifts Earth and other transdimensional ports like Atlantis and Worldgate. Many were

attracted to Phase World early in its history and have stayed to become an important part of life in the city of Center and on the space stations circling the planet. Members of this race are among the administrators and guardians of the city. There are also draconids living among the United Worlds of Warlock and wandering the cosmos as adventurers.

Available as a player character.

Alignment: Any

Attributes: I.Q. 3D6+3, M.E. 4D6+3, M.A. 3D6+3, P.S. 3D6+6, P.P. 3D6+3, P.E. 4D6+3, P.B. 4D6, Spd. 4D6; considered supernatural.

Size: Five to seven feet tall (1.5 to 2.1 m)

M.D.C.: 4D6×10 M.D.C. plus 1D6 per level of experience.

S.D.C./Hit Points: Become mega-damage creatures on Phase World and other dimensions with high P.P.E. levels.

Horror Factor: 10

P.P.E.: 1D6×10 unless they use magic (see below)

Average Life Span: 3,000 years; some may live two or three times as long.

Natural Abilities: Nightvision 90 ft (27.4 m), see the invisible, and bio-regenerate 3D6 M.D.C. every five minutes.



Other Powers: Draconids can choose to become either magicians or psychics, a subconscious process that occurs at birth. If they become magicians, they get all the powers of a *ley line walker* with a 1D6×10 P.P.E. bonus. If they become psychics, they acquire all the abilities and powers of a *mind melter* with a bonus of 1D4×10 I.S.P. points. In either case, use the draconid's experience points table presented in this book.

Combat: Natural combat abilities, plus those learned as skills.

Damage: Varies with P.S (supernatural). Bite inflicts 2D4 M.D.

Bonuses: +1 to save vs magic and +3 to save vs horror factor.

Vulnerabilities/Penalties: Draconids have the same vulnerabilities dragons do, thus any weapon, spell or potion that does extra damage to dragons will affect draconids in the same way.

R.C.C. Skills:

- Basic Math (+15%)
- Basic Radio (+10%)
- Basic Electronics (+10%)
- Language: Dragonese/Elven 98%
- Language: Trade Five 98%
- Language: Any two (+20%)
- Demon and Monster Lore (+15%)
- Pilot: Pick one (+10%)
- Wilderness Survival (+10%)
- W.P.: Any two

Hand to Hand: Basic

Hand to Hand: Basic can be changed to expert at the cost of one "other" skill or to martial arts (or assassin if an evil alignment) at the cost of two "other" skills.

R.C.C. Related Skills: Select an additional six other skills from the following list.

- Communications: Any (+10%)
- Domestic: Any (+5%)
- Electrical: Any
- Espionage: Any (+5%)
- Mechanical: Any
- Medical: Any
- Military: Any
- Physical: Any
- Pilot: Any (+5%)
- Pilot Related: Any (+5% if applicable)
- Rogue: Any (+5%)
- Science: Any
- Technical: Any (+10%)
- W.P.: Any
- Wilderness: Any (+10%)

Secondary Skills: The character also gets to select six secondary skills from the previous list. These are additional areas of knowledge that do not get the advantage of the bonus listed in parentheses.

Alliances and Allies: Draconids in Phase World are in close alliance with the Promethean race. They also work well with human and Wolfen wizards, the Seljuk race, and Elves.

Phantom R.C.C.

Phantoms are beings whose forms and minds are encoded in a pattern of light and electromagnetic energy. In many places, they are mistaken for psychic entities and "ghosts," although they are neither. They are one of the few races that has evolved in outer space, feeding on radiation and solar energy. Most of them have an alien culture that normal humanoids cannot hope to understand. However, not all phantoms are unknowable aliens. Many of them become "stowaways" on spaceships. One of the phantoms' powers is the ability to "read" the electromagnetic patterns of both machines and living things, which gives them a limited mind-reading capability. Those who come into contact with other sentient beings learn a lot about their cultures and customs, and many become attracted to them. As a result, a large percentage of phantoms have started imitating humanoid shapes and behavior. Some pretended to be normal physical beings, either to gain acceptance and love, or to mischievously trick unsuspecting humanoids. As a result, phantoms are legendary creatures known as tricksters and shapeshifters. They have been part of many stories, from comedies to tragedies. Over the millennia, they have evolved several strange cultures, mixing elements from other sentient civilizations with their own unique mind-set.

As a whole, phantoms are not an evil race. They resemble the faerie folk inasmuch as they love a good time, sometimes at the expense of others. However, they tend to be a lot more respectful and considerate of other life forms than faeries. Many of them have forged strong friendships, and even romantic relationships with corporeal beings. It is not unknown for a phantom to voluntarily scatter its pattern, effectively committing suicide, after the death of a humanoid friend or lover. Some are consummate clowns, often adopting a "cartoon" shape and performing all kinds of silly tricks. Others become dedicated champions of justice. Although serious phantoms can be encountered, humorless ones are the exception, not the rule.

Phantoms can be encountered in two states. Their true energy form can take any shape they desire, but their natural shape is some sort of geometrical configuration made of lights that keep flashing different colors. When they dwell among humanoids, many adopt humanoid forms. Phantoms can also build a solid body which they can inhabit indefinitely. While they inhabit this shell, they can interact with corporeal beings normally, but lose many of their powers and natural invulnerabilities.

The largest concentration of phantoms in the Three Galaxies is on Phase World. This race seems to get along very well with the prometheans and draconids and they are an important part of Phase World's defense systems.

Available as a player character.

Alignment: Any, but most are selfish.

Attributes: I.Q. 2D6+6, M.E. 2D6+6, M.A. 4D6, P.S. 0 (4D6), P.P. 0 (4D6), P.E. 3D6+6, P.B. 4D6 (special), Spd. 1D6×100 (4D6). The numbers in parentheses are used to determine the physical attributes of the shells phantoms can create to walk among humanoids. These physical attributes are considered to be supernatural.

Size: Varies with shape. Attributes and M.D.C. remain constant, however.

M.D.C.: 3D4×10 M.D.C., plus their physical shell adds an additional 2D6×10 M.D.C.

Horror Factor: 9

P.P.E.: 1D4×100 plus P.E. attribute; add 10 P.P.E. per experience level.

Average Life Span: 800 years

Natural Abilities:

All Forms: Can see in every possible wavelength, from visible light to radiation, heat emissions, infrared, ultraviolet, electromagnetic and radio. This allows the phantom to see the invisible, "read" radio signals as if he had a receiver, and detect radiation and most forms of energy, including magic (range for all senses: 2000 feet/610 m).

Energy Beams: Damage is 2D6 M.D. at level one, plus 1D6 per additional level of experience. Range: 500 feet (152 m). Each beam attack counts as one melee attack/action.

Limited Mind-Reading: Phantoms can read the electrical impulses in organic brains and can scan surface thoughts (whatever the person is thinking at the moment). This power has a base chance of success of 50% (plus I.Q. bonus and 3% per level of experience), and a range of 20 feet (6.1 m) plus 10 feet (3 m) per level of experience.

Energy Form: While in energy form, the phantom is invulnerable to all physical attacks, including explosions, bullets, hand to hand attacks, etc. Energy weapons, magic, magical weapons, and attacks from supernatural creatures affect energy phantoms, but only do half damage. While in energy form, the phantom cannot affect (lift or move) physical objects and has no physical attributes except P.E. The phantom can become invisible at will while in this form (see invisible and thermographic sensors will detect him, however).

Light Generation: By spending P.P.E., the energy being can generate light, from the equivalent of a flashlight (one P.P.E. per minute) to a blinding, million candlelight flash (30 P.P.E. per flash). 40 P.P.E. per melee round creates an aura of true sunlight (doing sunlight damage to vampires and other creatures of darkness).



Illusions: Phantoms can create illusions on all energy wavelengths. These creations of light and radiation are not solid but will fool most optical, thermographic and even radar sensors. For example, an illusion of a chunk of uranium would fool a geiger counter but when somebody tries to pick it up, his hands would go right through it. An illusion costs 10 P.P.E. times the size of the illusion in feet (33 P.P.E. times size in meters -use the biggest dimension of the illusion).

Shapeshifting: The phantom's natural form is a crystalline pattern of energy, but they can assume any shape they want. Common shapes are those of humanoids, angel-like beings, and cartoonish creatures (sometimes based on popular television 'toons).

Total Energy Conversion: The energy phantom can transform his energy pattern into that of a light beam for short periods. This ability costs 30 P.P.E. and allows the character to travel at the speed of light for a period equal to his P.E. in minutes. This period can be extended by spending an additional 10 P.P.E. for an additional number of minutes equal to his P.E. attribute.

While in this state, the phantom can attack a target as if he had been shot out of a laser cannon. Damage is 1D6×10 M.D. at first level but add 1D6×10 M.D. at levels three, five, seven, nine, eleven and thirteen. However, each time the phantom uses this attack it loses 3D6 M.D.C. points and burns up two melee actions. If M.D.C. is reduced to zero, this means the phantom has "burned off" his energy pattern and has been destroyed!

Physical Form: Creating a physical form takes 1D4 hours of intense concentration. Abandoning it and reassuming energy form takes one melee round. While in physical form, the phantom is an M.D.C. creature, but is affected by any M.D. attacks and physical limitations. The physical form can be of any shape desired, but its attributes and bonuses remain fixed. The attributes of the physical form are supernatural, allowing the creature to inflict mega-damage with punches and kicks.

Psionics and Psionic Powers: None

Combat: Special while in energy form, normal while in physical form.

Damage: Varies.

Bonuses: **Energy Form:** +4 on initiative, +5 to strike, +6 to dodge (cannot parry, pull punch or roll with attack). Add +1 to strike at levels four, seven and nine, and +1 to dodge at levels three, six, and ten. No other bonuses are applicable.

Physical Form: +1 on initiative, +1 to strike, +1 to parry and dodge. Plus any attribute or skill bonuses.

All Forms: +1 save vs magic and psionics, +4 to save vs horror factor.

Vulnerabilities/Penalties: While in energy form, the character can be imprisoned in energy fields. If the energy field is small enough, the phantom's energy pattern will be constrained and he will be trapped, unable to damage the force field in any way. Phantom catcher field generators can be purchased from the black market for 20,000 credits. They have a range of 60 feet (18.3 m).

R.C.C. Skills:

Basic Math (+20%)

Basic Radio (+15%)

Basic Electronics (+15%)

Navigation: Space (+25%)

Astronomy (+15%)

Astrophysics (+15%)

R.C.C. Related Skills: Select an additional twelve skills from the following list. Keep in mind that many of these skills will only be useful in physical form.

Communications: Any (+10%)

Domestic: Any

Electrical: Any (+5%)

Espionage: Any

Mechanical: Any

Medical: Any

Military: Any

Physical: Any

Pilot: Any

Pilot Related: Any (+5% if applicable)

Rogue: Any (+5%)

Science: Any (+5%)

Technical: Any (+10%)

W.P.: Any

Wilderness: Any

Hand to Hand: Any — Basic counts as one "other" skill, expert counts as two "other" skills, and martial arts or assassin (if an evil alignment) counts as three "other" skills.

Secondary Skills: The character also gets to select six secondary skills from the previous list.

Alliances and Allies: Phantoms are on good terms with prometheans and draconids. The silhouette race hates and fears phantoms because they can destroy shadows by creating dazzling lightshows.

Spacer O.C.C.

The Three Galaxies cover a lot of space. Somebody has to move things as well as people from one place to the next. That's where the spacers come in. Spacers are professional pilots and crew members of thousands of independent ships that fly through the galaxies, moving all kinds of cargo. Spacers typically disdain the security of working for a large corporation, or something in their past makes it impossible for them to get a safer, more secure job. They end up working for independent cargo haulers and transports, often for a share of the profits instead of actual pay. A lucky spacer owns his own ship, and most dream about the day they can join those lucky ranks.

Like the sailors of old, spacers travel from port to port, rarely settling down in one place for any length of time. The nomadic nature of this profession makes it attractive to people who are running from somebody or something, whether it be the authorities, creditors, family or themselves. Many spacers have shady pasts and their share of enemies. Some are outright brigands who engage in acts of piracy and smuggling. However, most leave such shenanigans to career criminals like the runner and space pirate.

Attribute Requirements: None, although a decent I.Q., P.S. and P.E. are recommended.

O.C.C. Abilities and Bonuses: The spacers' experience in dealing with the vacuum of space gives them a +2 bonus to any saves against explosive decompression or other space dangers.

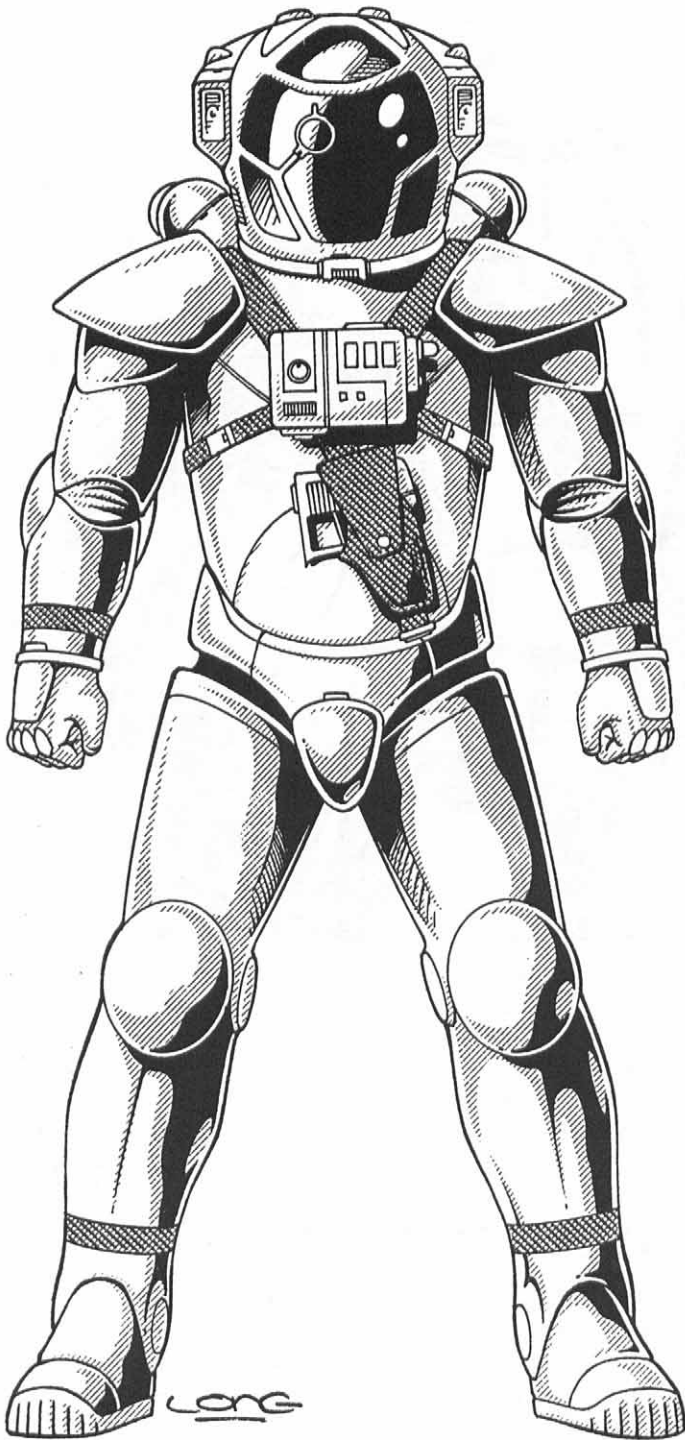

O.C.C. Skills:

- Basic Math (+10%)
- Basic Radio (+15%)
- Spaceship Mechanics (+10%)
- First Aid (+10%)
- Movement: Zero Gravity (+15%)
- EVA (+10%)
- Pilot: Two spaceship types (+15%)
- Read Sensory Equipment (+10%)
- Computer Operation (+10%)
- W.P.: Any two
- Hand to Hand: Basic (normal)
- Hand to Hand: Basic can be changed to expert at the cost of one "other" skill, or martial arts (or assassin if an evil alignment) at the cost of two "other" skills.

O.C.C. Related Skills: Select 8 other skills. Plus select two additional skills at levels four, seven, nine, and twelve.

- Communications: Any (+10%)
- Domestic: Any (+5%)
- Electrical: Any (+5%)
- Espionage: None
- Mechanical: Any (+5%)
- Medical: Paramedic only.
- Military: Demolitions only
- Physical: Any
- Pilot: Any (+10% where applicable)
- Pilot Related: Any (+5%)
- Rogue: Any
- Science: Any (+10% on math)
- Technical: Any (+10% on language and computer skills)
- W.P.: Any
- Wilderness: Any

Secondary Skills: The character can also select seven secondary skills from the previous list. These are additional areas of knowledge that do not get the advantage of the bonus listed in parentheses.

Standard Equipment: Spacesuit or space capable M.D.C. armor suit, multitool, one hand weapon of choice (usually pistol size) and ammunition/E-clips, knife or blackjack, handheld computer, hand-held communicator, work jumpsuit, and a set of civilian clothes.

Money: 4D6x1000 credits.

Cybernetics: Starts with none, but may get cybernetic enhancements.

Galactic Tracer O.C.C.

The spaceways equivalent of the bounty hunter O.C.C. (see **Rifts Mercenaries**). The galactic tracer pursues wanted criminals throughout the galaxy. Theirs is a dangerous and distrusted profession. Local policemen do not trust tracers and consider them to be greedy and reckless mercenaries or vigilantes. Most adventurers will have little to do with these manhunters, since they are known to turn against their former comrades, if the price is right (this is only true of characters with an anarchist or evil alignment). As a result, galactic tracers only work well with each other and the occasional team of adventurers or mercenaries willing to overlook such things.

Available as a player character.

Attribute Requirements: I.Q. 8, P.E. 11 or higher. A high P.S. and P.P. are helpful but not required.

O.C.C. Abilities and Bonuses: +2 on initiative, +1 to strike.

O.C.C. Skills:

- Basic Math (+10%)
- Radio: Basic (+10%)
- Literacy in any two languages (+15%)
- Surveillance Systems (+10%)
- Intelligence (+10%)
- Computer Operations (+15%)
- Detect Ambush (+10%)
- Pilot Small Starship (+10%)
- W.P. Energy Pistol
- W.P. Energy Rifle
- W.P. One of Choice

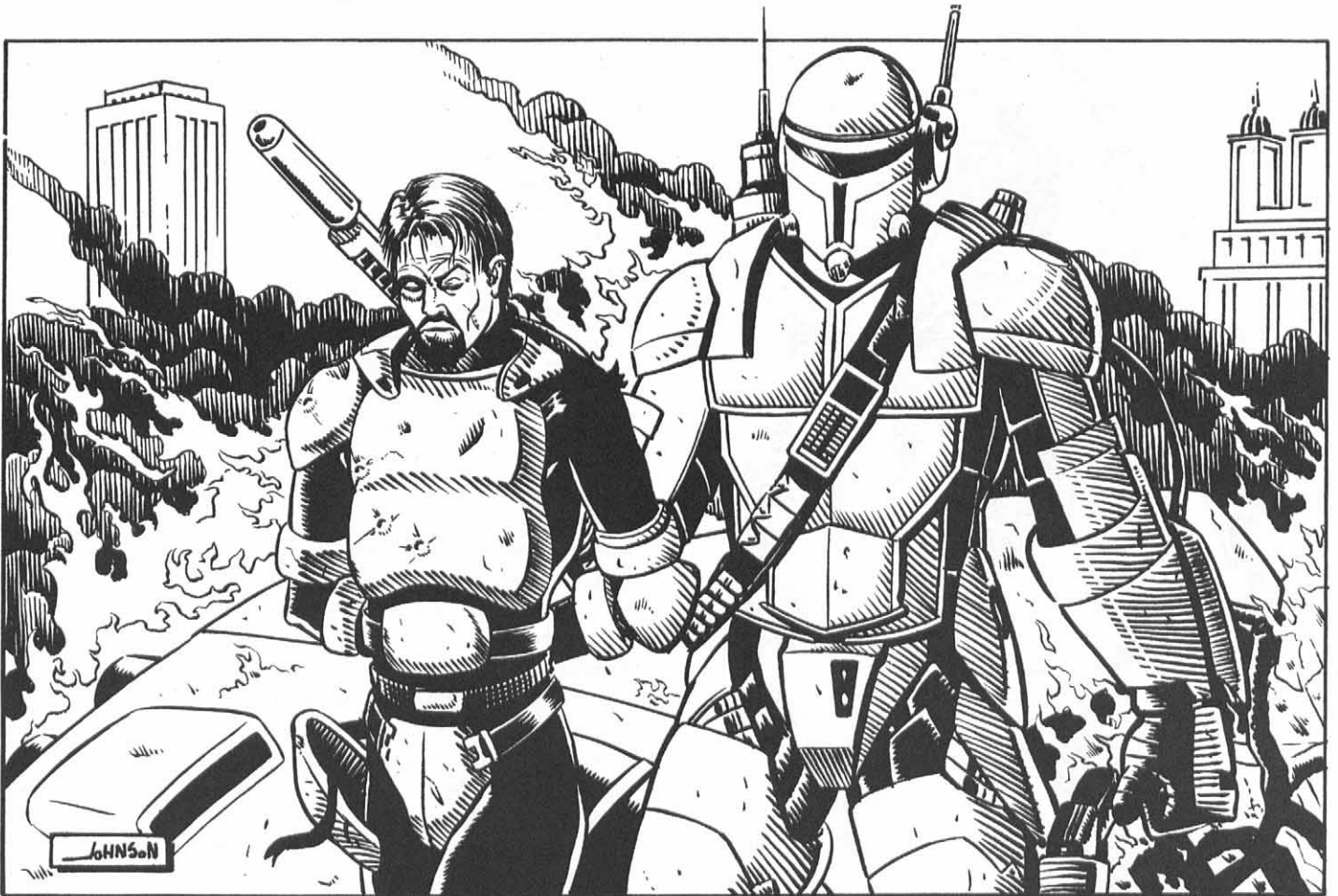

Hand to Hand: Expert

Hand to Hand: Expert can be changed to martial arts at the cost of one "other" skill (or assassin if an evil alignment).

O.C.C. Related Skills: Select seven other skills, but at least two must be selected from espionage. Plus select two additional skills at level three, two at level six, one at level nine, and one at level twelve.

Communications: Any (+5%)

Domestic: Any (+5%)

Electrical: Basic electronics only (+5%)

Espionage: Any (+5%)

Mechanical: Any

Medical: Paramedic only

Military: Any

Physical: Any

Pilot: Any (+10%)

Pilot Related: Any (+10%)

Rogue: Any (+6%)

Science: Any

Technical: Any (+10%)

W.P.: Any

Wilderness: Any (+5%)

Secondary Skills: The character also gets to select six secondary skills from the previous list. These are additional areas of knowledge that do not get the advantage of the bonus listed in parentheses. All secondary skills start at the base skill level. Also, skills are limited to (any, only, none) as previously indicated in the list.

Standard Equipment: Two energy weapons of choice, 2D4 extra E-clips for each, two melee weapons of choice (sword,

knife, etc.), suit of personal M.D.C. armor, communicator set, and handheld computer. The GM can also let the character own a small spaceship (capacity for 2 to 8 passengers and a little cargo).

Money: 3D6×1000 credits to start.

Cybernetics: Can have up to 1D4 cybernetic implants.

Space Pirate O.C.C.

Not all spacers are content with making a living through honest (or semi-honest) trade. Some turn to smuggling (see the Runner O.C.C.), while still others become full-time marauders and criminals. Space pirates are hated and feared by the spacers and other space travelers who see them as parasites, thieves and murderers. The life of the space pirate has been romanticized by books and movies but in reality, it is a harsh, brutal and often short existence. Most pirates live on light ships, able to damage and capture small merchant vessels, but are helpless against real military ships, or even a well-defended freighter. They are not welcomed at most spaceports and even where they are, they run the risk of meeting a galactic tracer or a victim's friend or relative seeking revenge.

A few pirates join the life because they had no choice. These often have a rough code of honor which prevents them from murdering or molesting innocent victims. Many ex-pirates have switched sides and become law-enforcers, freedom fighters or regular spacers. However, the typical pirate is a cutthroat who will do whatever it takes to get what he wants, and who will even turn on his comrades if it is to his benefit.

Available as a player character (as well as NPC villains).

Attribute Requirements: P.S. 10 and P.P. 10 or higher.

O.C.C. Abilities and Bonuses: +1 to parry and dodge, +2 to save vs horror factor.

O.C.C. Skills:

Basic Math (+10%)

Basic Radio (+10%)

Movement: Zero Gravity (+5%)

EVA (+10%)

Pilot: Two spaceship types (+10%)

Weapon Systems (+10%)

Read Sensory Equipment (+10%)

Streetwise (+10%)

W.P. Energy Pistol

W.P. Energy Rifle

W.P.: One of Choice

Hand to Hand: Expert

Hand to Hand: Expert can be changed to martial arts or assassin at the cost of one "other" skill.

O.C.C. Related Skills: Select 6 other skills. Plus select two additional skills at level three, two at level six, one at level nine, and one at level twelve. All new skills start at level one proficiency.

Communications: Any

Domestic: Any

Electrical: Any

Espionage: Any (+5%)

Mechanical: Any

Medical: Paramedic only

Military: Any (+5%)

Physical: Any

Pilot: Any (+5%)

Pilot Related: Any (+10%)

Rogue: Any (+5%)

Science: Any

Technical: Any (+5%)

W.P.: Any

Wilderness: Any

Secondary Skills: The character also gets to select four secondary skills from the previous list. These are additional areas of knowledge that do not get the advantage of the bonus listed in parentheses. All secondary skills start at the base skill level. Also, skills are limited (any, only, none) as previously indicated on the list.

Standard Equipment: Two energy weapons of choice, 2D4 extra E-clips for each, two melee weapons of choice (sword, knife, etc.), suit of personal M.D.C. armor, communicator set, and hand held computer. The GM can also let the character own a small spaceship (capacity for 2 to 8 passengers and a little cargo).

Money: 2D6×1000 credits plus 1D6×1000 credits' worth of items for trade or sale to start.

Cybernetics: Can have up to 1D4 cybernetic implants. Additional items can be purchased as the character desires. Borgs and headhunters are always a welcomed addition to a pirate's crew.

Runner O.C.C.

"Runner" is the common term for smugglers in the Three Galaxies. They fly illegal cargoes through the Three Galaxies, making enormous profits — if they survive. Runners run the gambit, from greedy entrepreneurs who will deal with anybody as long as the price is right, to romantic adventurers who only break the laws of tyrannical governments. Some runners are also con-men and pirates. Most of them are something in between these extremes — people trying to make a living in a dangerous universe. Many have a code of conduct which includes never betraying a fellow runner. Runners need contacts to smuggle their illegal merchandise onto controlled worlds and spaceports. These contacts must trust their co-conspirators, or a the entire scheme will fall apart. Thus, the best runner will endure incredible amounts of torture, some would even die, before betraying a friend, contact or confidant! They are among the most trustworthy scoundrels in the universe. The black markets of the Three Galaxies are run by, and kept supplied by runners.

The distinction between regular spacers and runners is not obvious to most casual observers. Many spaceship crews engage in some sort of illicit trading from time to time. However, the typical runner is somebody who deals mostly in smuggling and only deals in legitimate work when times are tough. Most quickly acquire a reputation for smuggling and known runners are often refused entry to major or respectable spaceports. This means many runners will have a dozen different aliases and fake identity documents.

Available as a player character.

Alignment Note: A runner can be any alignment, but the most trustworthy tend to be principled and aberrant.

Attribute Requirements: I.Q. 7, P.E. 10 or higher.



O.C.C. Skills:

Two Languages of Choice (+20%)
Basic Math (+20%)
Basic Radio (+15%)
Radio: Scramblers (+10%)
Cryptography (+10%)
Movement: Zero Gravity (+5%)
EVA (+5%)
Pilot: Two spaceship types (+15%)
Weapon Systems (+5%)
Read Sensory Equipment (+15%)
Streetwise (+12%)
W.P.: Two of Choice
Hand to Hand: Basic

Hand to Hand: Basic can be changed to expert at the cost of one "other" skill, or martial arts (or assassin if an evil alignment) at the cost of two "other" skills.

O.C.C. Related Skills: Select six other skills. Plus select one additional skill at level three, two at level six, one at level nine, and one at level twelve. All new skills start at level one proficiency.

Communications: Any (+10%)
Domestic: Any (+5%)
Electrical: Any
Espionage: Forgery only
Mechanical: Any
Medical: First aid or paramedic only.
Military: None
Physical: Any
Pilot: Any (+5%)
Pilot Related: Any
Rogue: Any (+8%)
Science: Any
Technical: Any (+10%)
W.P.: Any
Wilderness: None

Secondary Skills: The character also gets to select four secondary skills from the previous list. These are additional areas of knowledge that do not get the advantage of the bonus listed in parentheses. All secondary skills start at the base skill level. Also, skills are limited to (any, only, none) as previously indicated in the list.

Standard Equipment: A space-capable suit of mega-damage armor, a wardrobe of casual travel clothes (wardrobe can be worth 2D4×1000 credits), handheld computer, handheld communicator, multitool, language translator, two sets of forged identity papers and piloting license, and personal items. May own a small spaceship (or several characters can pool their resources and acquire a larger spaceship; G.M.'s call).

Money: 2D6×100 credits and black market items worth 2D6×1000 credits.

Cybernetics: None to start and most avoid them.

Colonist O.C.C.

The Three Galaxies have many undiscovered and thinly populated planets. Vast new frontiers wait to be explored and conquered. Millions of people leave their native planets in search for a new home, fortune or adventure. They may be fleeing overcrowded conditions, poverty, or religious persecution. Some might be driven by greed, while others simply wish a better life for themselves and their offspring. Still others wish to create their own version of paradise.

Unlike the colonists of the past, this new breed of pioneers has to face some degree of government regulation. Both the CCW and the Transgalactic Empire have programs to train would-be colonists to help them face the rigors of survival in space, and on strange worlds. Only those who pass are given a license to go to uninhabited planets and stake a claim. Sometimes, however, colonists take over planets on their own and may even invade worlds that are claimed by one or more galactic civilizations. This often results in wars or outright massacres. Such is life on the space frontier.

Those who survive the hardships of taming a new ecology are tough and capable men and women, able to deal with almost anything.

Many of the children of colonists grow tired of the ceaseless struggle for survival. Some manage to escape their parents' dream, joining the ranks of spacers and other adventurers, where their hard-learned skills will serve them well. A number of the CCW Exploration Corps members are former colonists (in such cases, use this O.C.C. instead of the standard CAF ones).

Available as a player character.

Attribute Requirements: None other than a spirit of hope and a desire to explore. However, those with a P.S., P.E. and M.E. of 10 or higher are best suited for the job and most others washout in training camp.

O.C.C. Abilities and Bonuses: +1 to save vs poison and toxins and +1 to save vs horror factor.

O.C.C. Skills:

Basic Radio (+5%)
Wilderness Survival (+20%)
Land Navigation (+15%)
Track Animals (+10%)
Identify Plants and Fruits (+15%)
Botany (+10%)
First Aid (+10%)
Climbing
Swimming
W.P.: One of choice
Hand to Hand: Basic
Hand to Hand: Basic can be changed to expert at the cost of one "other" skill or martial arts or assassin for the cost of two "other" skills.

O.C.C. Related Skills: Select 8 other skills. Plus select one additional skill at level three, two at level six, one at level nine, and two at level twelve. All new skills start at level one proficiency.

Communications: Any
Domestic: Any (+10%)
Electrical: Any

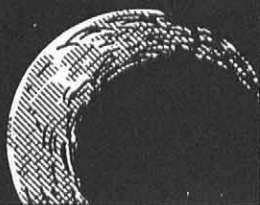

Espionage: Detect ambush and detect concealment only (+5%).

Mechanical: Any

Medical: Paramedic or holistic medicine only (+5%).

Military: None

Physical: Any

Pilot: Any (+5%)

Pilot Related: Any

Rogue: Any

Science: Any

Technical: Any (+5%)

W.P.: Any

Wilderness: Any (+10%)

Secondary Skills: The character also gets to select five secondary skills from the previous list. These are additional areas of knowledge that do not get the advantage of the bonus listed in parentheses. All secondary skills start at the base skill level. Also, skills are limited to (any, only, none) as previously indicated in the list.

Standard Equipment: Suit of light mega-damage armor, one energy weapon of choice, basic survival kit, first-aid kit, gas mask, goggles, canteen, handheld computer, tent, set of sturdy work clothes, hand axe and utility knife.

Money: Only 2D6×100 credits.

Cybernetics: None to start.

Other Rifts O.C.C.s and R.C.C.s

Many Rifts O.C.C.s from the basic book or other sourcebooks also exist in Phase World and the Three Galaxies. Outlined below are some of the suggested origins and modifications for those O.C.C.s in the Phase World milieu. This, of course, does not affect characters who have reached Phase World from other dimensions.

Borgs and Cyber-Docs: Bionic modifications are common in some cultures, but are frowned upon in the CCW. Many borgs are spacers, runners, tracers, pirates and mercenaries (use the Coalition/Military Mercenary Borg, but replace the piloting skills with spaceship piloting skills, and climbing with Movement: Zero gravity). Cyber-docs are relatively rare.

Coalition Soldiers: Obviously, the only CS soldiers in the Phase World universe would be travelers from the Rifts Earth dimension. CS soldiers will have to do some rethinking on their basic philosophy if they get stuck in the Phase World and Three Galaxies environment; human supremacy movements are few and rather powerless in this part of the Megaverse.

Crazies and Juicers: M.O.M. and Juicer modifications are rare in most cultures of the Three Galaxies. Only a few planets offer these modifications: Phase World is one of them. No O.C.C. modifications are necessary.

Cyber-Knights: Cyber-knights developed on Rifts Earth. A few handfuls of these champions have reached Phase World and the surrounding galaxies through magic or Rifts. Most will eventually become lawmen, or team up with cosmo-knights and other champions of good.

Glitter Boy: The Glitter Boy armor is sold at Phase World (it is unknown whether the suits are purchased from Earth or manufactured somewhere else), so a number of robot pilots that specialize in this vehicle exist in this alien setting. No changes are necessary.

Headhunters: A very common O.C.C. among starship crews, mercenary companies, and lawless places like the city of Center. Many members of the freedom fighters battling the Transgalactic Empire are also headhunters. No O.C.C. changes are necessary.

Body Fixer and Operators: These O.C.C.s are common and can be encountered on spaceships, at space stations, cities and outposts. No O.C.C. changes are necessary.

City Rats: Like their namesake, they are extremely common in any large city and space station. Basically unchanged.

Rogue Scientists and Scholars: Unlike their Rifts counterparts, these O.C.C.s are not persecuted at most places. Adventurer sages are a common sight in the Three Galaxies, though. With a whole universe to explore, many visionaries abandon their comfortable academic lives and set off in life-long quests for knowledge. No modifications are necessary, except for some emphasis on space travel skills.

Wilderness Scouts: Most likely to be found on remote planets or small colonies (see the Colonist O.C.C.), or as part of an exploration team. Fundamentally the same.

Men of Magic O.C.C.s: All the O.C.C.s described in the Rifts basic book exist in the Three Galaxies, as well as temporal wizards and warriors (from **Rifts England**), necromancers (**Rifts Africa**), diabolists, summonners, warlocks and witches (**Rifts Conversion Book One**). Magicians are especially common among the United Worlds of Warlock, fairly common on Phase World, and rare in most other civilizations. Other magician classes, such as the African witch doctor, voodoo priest, and biomancer are much rarer, and are only found among dimensional travelers.

Mercenaries: All the O.C.C.s described in the **Rifts Mercenaries** book are basically applicable in the Phase World environment. With all the smuggling, corruption, and conflicts in the Three Galaxies, mercenaries can easily find work to ply their trades. No modifications are necessary, except for some emphasis on space travel skills. Naruni Enterprises and the Uteni are also detailed to some degree in this sourcebook.

Psychic O.C.C.s: Mind melters and mind bleeders (see **Rifts Africa** for the latter) exist in most parts of the Three Galaxies. Both the CCW and the Transgalactic Empire have psionic research centers. Psi-stalkers are relatively rare. Mutant animals with psionic powers are usually travelers from other dimensions.

True Atlanteans (Rift Atlantis): There is an Atlantean-controlled planet in the UWW, so all Atlantean O.C.C.s can be found there, with the exception of the Atlantean Monster-Slayer (see **Rifts South America**), which is exclusive to one Atlantean Clan.

Wormwood O.C.C.s: Characters found in the **Rifts Dimension Book One: Wormwood** can arrive on Phase World. Characters with symbiotic organisms will lose them and most of the monster races are not very cooperative toward gentler humanoids.

R.C.C.s: Virtually any R.C.C. described in any Rifts (or for that matter, any Palladium game or any other RPG) can exist on Phase World. The Rifts conversion books, worldbooks and sourcebooks have dozens of such races. Feel free to add them as unusual and rare dimensional travelers.

Also see **Aliens Unlimited** with over 100 different aliens and monster races all accompanied by *Rifts Notes* for easy integration into the **Rifts RPG** world setting and **Phase World**. These characters are most likely to be visitors from a distant galaxy, or another dimension.

Naruni Enterprises (NE)

Transdimensional Weapons Merchants

Personnel: 200 million sentients (estimated) working full time, plus 1-3 billion “temps.” **Note:** This number only deals with Naruni Personnel located in the Three Galaxies; nobody knows how many people work for the corporation throughout the Megaverse. Also, this does not include slaves or indentured servants.

Racial Breakdown:

True Naruni (0.1%; less than 200,000)

Uteni Shifters (30%)

Molock Enforcers (20%)

Changelings (5%)

Pleasureurs (5%)

Humans (10%)

Others (30%)

Naruni Enterprises is a transdimensional weapons and vehicles manufacturer first introduced in the pages of **Rifts Mercenaries**. The company is not native to the Phase World universe, but it has conducted business in the dimension for several centuries, and has its main headquarters on Phase World in the city of Center. Naruni Enterprises has stores and warehouses in the CCW, the Transgalactic Empire and many independent planets, including Phase World itself. Naruni equipment is universally respected, from energy pistols to starships. These top-notch products are purchased by adventurers, mercenaries and governments throughout the Three Galaxies and across the Megaverse. Naruni weapons are expensive, but the corporation is very generous with credit plans and loans. Perhaps too generous, but desperate people (and many weapon buyers are desperate) don't pay too much attention to the terms of sale as long as they can walk away holding the nastiest death-dealing equipment in the Megaverse. The problems occur if the buyers cannot pay their debts. Naruni Enterprises always collects what it is owed. Always.

There are options, of course. The winner of a war can pay its debts by seizing the property of the defeated side and using it as payment, selling the losers into slavery, or even making land grants to the NE corporation using conquered territories. Naruni Enterprises doesn't care where the money or goods come from, as long as they are paid on time. Naruni appraisers are fair when

they determine the value of goods or services, and they will accept most forms of chattel and property as payment.

If the debtors lost the war or cannot meet the payment schedule even after winning, the company shows its nasty side. Debtors have often been seized and sold into slavery. Sometimes, their families and entire troops have joined them if one slave was not enough to meet the debt. Governments in debt have paid with mineral rights, crops and, on at least half a dozen occasions, their entire planet! At first, Naruni Enterprises will use legal means to collect unpaid bills. The Legal Department recruits the best lawyers available in the region. When “legal” means (including forced evictions, indentured servitude for several years, seizure of property, garnished wages and so on) are not enough, NE calls in another set of specialists. Everybody is afraid of the **Naruni Debt Collectors (NDC)**, one of the most powerful military forces in the Megaverse! The NDC is equipped with weapons and vehicles far ahead of what Naruni “sells” to its customers. A collector squad can consist of only a couple of enforcers, or an entire planetary invasion force, complete with starship support!

The Naruni Board of Directors

The Naruni Board of Directors has 20 to 24 members, depending on the current situation regarding internal politics and intrigue. More than one member has been forced to resign, or has been “retired” permanently by a 20 mm plasma cartridge round. Two-thirds of the board seats are held by True Naruni and Uteni traders (each of them a multi-trillionaire), and who collectively hold 60% of all Naruni Enterprises stock. Another important member is the godling Thraxus, who holds 5% stock and whose value is in the trillions of credits. The rest of the board are from all over in the Megaverse, including a demon lord and an alien intelligence!

The express goals of the company are simple: Expand their holdings and assets, stay on the leading edge of technology, and “maintain a climate favorable for the marketing and distribution of Naruni products.” This last phrase can mean a number of things — including the need to maintain a climate of war in the Megaverse to guarantee a market for advanced weaponry.

Naruni Enterprises, unlike other transdimensional forces such as the Splugorth, is not in the business of forcible conquest. They see war as a wasteful activity that rarely pays for itself. It is far more profitable to sell weapons to those involved in war! The few large-scale conflicts in which Naruni Enterprises was directly involved were launched against the weakened survivors of a previous war, who were unable to put up much resistance and who were enslaved and sold to pay their debts.

Naruni Enterprises will not turn down cash transactions, and makes a healthy profit from perfectly legal sales to those who can afford the prices. However, not all of Naruni's dealings are above-board. The Board of Directors has an elite unit of secret employees, the **Social Studies Branch**. On the outside, this branch is funded to examine social conditions in the Three Galaxies and the rest of the Megaverse, supposedly as harmless market research. In reality, funds go to mercenaries, secret agents and other freelancers, most of whom do not realize who they are working for. These agents then help instigate wars and skirmishes in selected areas. The Social Studies Branch is not used to make trouble, because there are enough wars and conflicts around to satisfy the Board of Directors. Should things slacken off, however, the SSB will conduct a little "social engineering" of their own.

Another important branch of the company is the **Research and Development Department**. This department reports directly to the Board of Directors, many of whom are renowned weapon designers themselves. However, few new or innovative weapon systems have been developed over the last few decades. It seems that technological development has become stagnant for some reason. The Board of Directors is particularly frustrated by Naruni's inability to learn the secrets of phase technology and its lack of success in competing in the techno-wizard market. Rifts Earth is viewed with a mixture of fear and greed. The amazing advances made by such human enclaves like Triax and the Coalition indicate that in less than fifty years that planet may match or surpass the best that even Naruni has to offer. The company is considering expanding its base of operations on that planet in the near future.

Naruni on Rifts Earth

As shown in *Rifts Mercenaries*, the reception of Naruni Enterprises on Rifts Earth hasn't been all NE had expected. The company has been beset by spies, saboteurs, and an effective discrediting campaign orchestrated by the Coalition States and competitors like Northern Gun. A campaign that is all the more effective for the fact that it has more than a grain of truth. Initial sales (especially to large nations) have been disappointingly low. Their biggest market has been in remote and less developed areas, and among brigands and outlaws.

Naruni will not take this opposition lying down. The company has not been a force in the Megaverse for thousands of years by retreating in the face of competition. The board members who have studied the situation have dispatched members of the *Social Studies Branch* to Earth. A number of proposed solutions have already been outlined.

The first one is to wait until the Coalition States actively attacks another nation. Faced with extermination and genocide, places like Tolkeen, Lazlo and the Federation of Magic will be far less reluctant to deal with Naruni Enterprises. The risk of this



ploy is that Naruni might get some good sales, but they might come too late to prevent a Coalition victory, which would make collecting debts a difficult task. To get what would be owed to them, NE would have to effectively declare war on the Coalition, resulting in a protracted war that would not be worth the expense.

Another possibility is the co-opting of rival companies. The Social Studies Branch has outlined a plan in which Naruni will start selling its products in alliance with Northern Gun! Naruni would offer Northern Gun some of the advanced technologies they possess and would provide capital and expert labor to set up several factories in North America. These facilities would produce advanced, cheap weaponry under the Northern Gun label, thereby eliminating the stigma that Naruni Enterprises has of being menacing aliens! An offer like that would be hard to refuse, since it would mean incredible profits! If Northern Gun rejects the offer, the company would turn to Wilk's, or Wellington Industries, or might resort to bribery, blackmail or extortion to influence one of the human corporations. If the deal goes through, Naruni Enterprises would rely mostly on human representatives, maintaining a very low profile and fostering the illusion that Northern Gun is solely responsible for the new weapons.

In a few years, Northern Gun could outmatch Triax as the leader in weapons production. Accusations from the Coalition would not be believed by many, and Naruni would quickly control a large share of the market, with great potential for expansion. This plan is being seriously considered, but the Board of Directors is concerned with the creativity and intelligence of the inhabitants of Rifts Earth. Giving Northern Gun too much technology might give humans the means to forge their independence from all invaders, including Naruni Enterprises itself.

Europe is also being watched with interest. Naruni has its own spies in the NGR, and even among the Gargoyle Empire (see **Rifts Triax and the NGR**). The company might want to exploit a possible break between the gargoyles and their Splugorth allies. If that happened, Naruni Enterprises might step in and offer its merchandise to the gargoyles. They might also approach the Angel of Death and her Brodkil allies (see **Mindwerks**), and might trade advanced bionic and force field technologies in return for the secrets of *psynetics*. This could end in a gargoyle empire dominating all of Europe, or a genocidal war involving the Naruni-supplied gargoyles and brodkil on one side, and the NGR on the other (possibly with the covert support of the Splugorth). The only real winner of such a war would be Naruni Enterprises.

The discovery of any of these plots (by the player characters, perhaps?) would further damage the credibility of Naruni Enterprises. However, this might not damage their sales. A company does not have to be liked to be successful.

Naruni Repo-Bot R.C.C.

Almost every sentient in the Three Galaxies is deathly afraid of missing a payment to Naruni Enterprises. If the terms of an agreement are not fulfilled (and there are so many terms in the finest of print), NE sends one or more of its enforcers, the Repo-Bots, to collect any moneys due. And they will collect the debts, any way they can.

Repo-Bots are robots with organic brains. Nobody knows if these brains are those of willing people, or victims of enslavement. Their personalities are often submerged with an overwhelming sense of loyalty to Naruni Enterprises, programmed by their employers/owners. They are intelligent and show initiative, but they *always* look out for the best interests of the company. They can be shrewd negotiators, skillful diplomats, ingenious strategists, and merciless killers. It is believed that their mental programming is based on the mind-pattern of a top-notch secret agent and soldier, now long dead. Or perhaps the programming used the minds, memories and skills of several dozen such beings, combining the best traits of each one.

The Repo-Bots are clear proof that Naruni Enterprises reserves the best technology for its own use. These "super-cyborgs" easily outperform any bionic organism in the Three Galaxies, with the possible exception of the Wolfen Quatoria warriors, and the ancient machine people. Each of these cyborgs is as tough as a squad of power armor troopers and is capable of operating in any environment, including space. Repo-Bots operate in squads of four, platoons of 16, companies of 64, or battalions of 256 cyborgs. On very rare occasions, thousands of these beings have been gathered and sent against a given target.

Alignment: Most are considered aberrant, with absolute loyalty to Naruni Enterprises (cannot be bribed or paid off to do anything against the company).

Attribute Requirements: M.E. 12 or higher.

O.C.C. Abilities and Bonuses:

1. Robot Body: Repo-Bots have completely mechanical bodies with the following M.D.C.

* Head — 200 M.D.C.

Arms (2) — 200 M.D.C.

Legs (2) — 240 M.D.C.

Force Field — 300 M.D.C.

Main Body — 600 M.D.C.

Destroying the head kills the Repo-Bot (requires a called shot at -2 to strike). The force field M.D.C. must be depleted before damage can be applied to the head or the rest of the robot.

2. Robot attributes: The robot has a P.S. of 50, P.P. 26 and can run at up to 100 mph (160 km) indefinitely, without tiring; uses a nuclear power plant with an energy life of 50 years.

3. Built-in Weapon Systems: The Repo-Bot has a built-in particle beam weapon (1D4×10 M.D. per shot, 2000 feet/610 m range, unlimited payload), a plasma flamethrower (5D6 M.D. to a 20 feet/6.1 m area, 200 feet/61 m range, unlimited payload) and a finger-laser (4D6 M.D., 2000 feet/610 m range, unlimited payload). Plus any handheld weapon (energy pistol, rifle, rail gun, etc.) can be used by the bots. Plus an energy weapon can be plugged into the repo-bot's power supply for an unlimited payload.

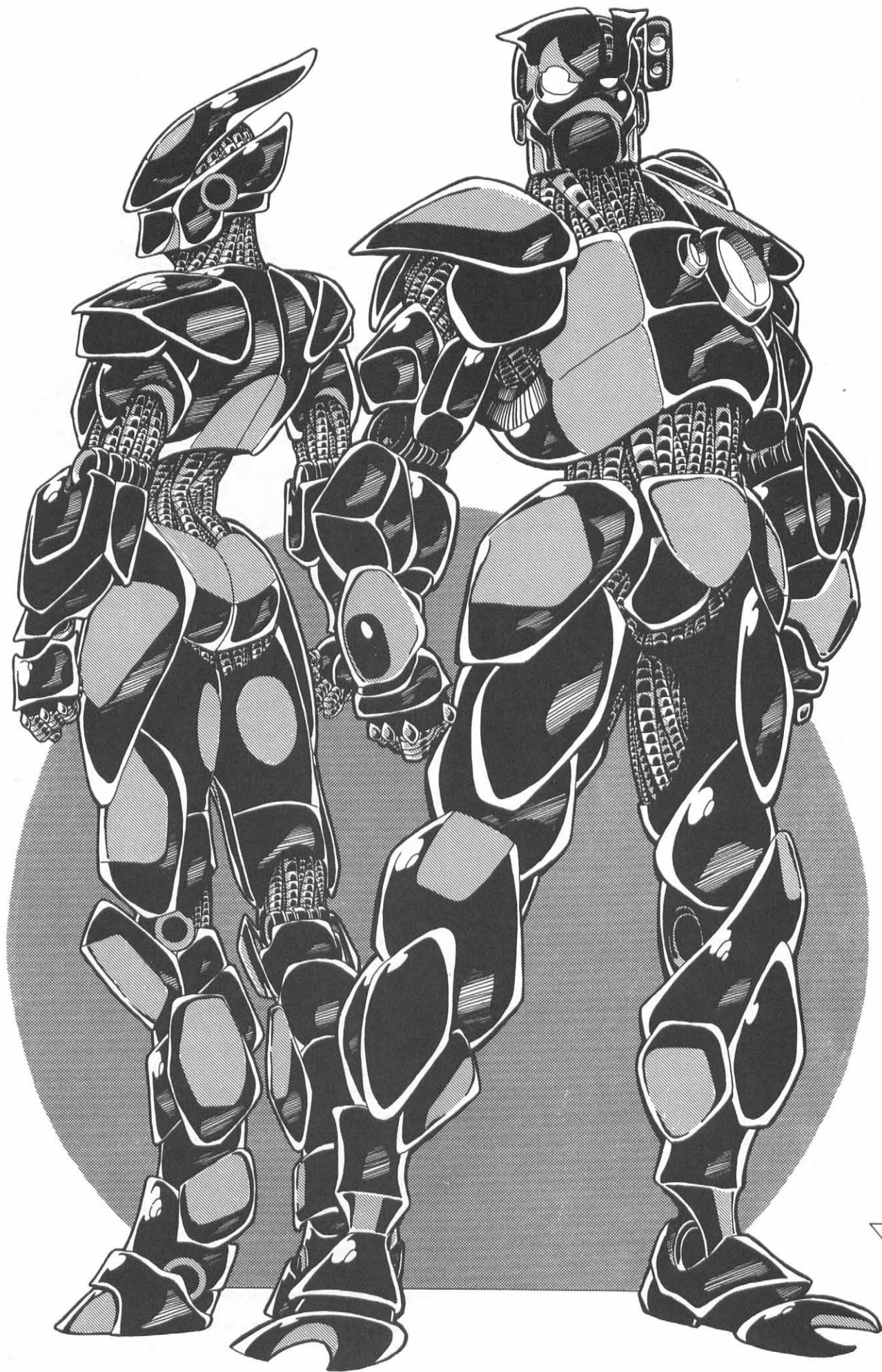

True Naruni R.C.C.

4. Robot/Cybernetic Systems: Include the following: Multi-optic eye, infra/ultra eye, ultra-ear, amplified hearing, polarized filters, and sensor hand. Internal oxygen supply will keep the Repo-Bot's brain alive for 96 hours.

5. Bonuses (Includes P.P. bonuses): The Repo-Bots are +2 on initiative, +8 to strike, parry and dodge, +2 to pull punch, +2 to roll with impact, +10 to save vs horror factor, impervious to disease, toxins, gases, and radiation, don't need air to breathe, and are +1 to attack per melee.

O.C.C. Skills:

Basic Radio (+15%)

Two Languages of Choice (+15%)

Computer Operations (+10%)

Pilot: Pick two (+15%)

Weapon Systems (+15%)

Tracking (+10%)

Land Navigation (+15%)

W.P. Two of choice

Hand to Hand: Expert

Hand to Hand: Expert can be changed to martial arts or assassin at the cost of one "other" skill.

O.C.C. Related Skills: Select 10 other skills. Plus select two skills at level three, two at level six, and one at levels nine and twelve.

Communications: Any (+10%)

Domestic: Any

Electrical: None

Espionage: Any (+5%)

Mechanical: None

Medical: None

Military: Any (+10%)

Physical: None

Pilot: Any (+10%)

Pilot Related: Any (+5%)

Rogue: Any

Science: None

Technical: Any (+10% on computers and languages)

W.P.: Any

Wilderness: Any

Secondary Skills: The character also gets to select four skills from the previous list. These are additional areas of knowledge that do not get the advantage of the bonus listed in parentheses. All secondary skills start at the base skill level.

Standard Equipment: Plasma Hand Cannon (2D6×10 M.D.), two energy weapons of choice, and receipts for the property to be repossessed, or unpaid bills. They may also be given a space shuttle with an FTL drive for travel and pursuit

Money: 1D4×1000 credits.

Cybernetics: Can select an additional 1D4 cybernetic implants.

Note: The Repo-bot makes a better NPC villain than a player character. Player characters will be loyal agents of Naruni Enterprises unless there is a super-rare glitch in their memory or programming.



Most people think that the Uteni race (see **Rifts Mercenaries**) are the true Naruni that founded and own the corporation. The truth is that the Uteni are simply the front-men for the mysterious Naruni, a species whose origins and goals remain unknown. The Naruni people don't make public appearances, and always remain behind the scenes. But there is no question that they are the driving force behind the corporation.

The reason why the Naruni prefer to avoid the public eye is simple: their shape is hideous. Naruni are heavy-set bipeds with hippo-like skins and builds. Three long tentacles run down from where a human's nose would be (which are used for both eating and breathing). The tentacles end up in tiny fanged mouths reminiscent to the Splugorth (some people occasionally suggest that the Naruni may be some sub-species of the Splugorth, although their differences are much greater than any similarities). The Naruni's eyes are narrow slits with red, iris-less eyes peeking through. They usually wear cloaks to partially cover their disgusting features. Also, they are supernatural creatures whose presence disturbs and scares psychics and other sensitives.

The fact that the Naruni are supernatural beings has led many people to question their motives and goals. Although they seem content in their role as weapon suppliers, it is very possible that the Naruni have even more sinister plans in store for the Three Galaxies, and other parts of the Megaverse.

Alignment: Any, but most are aberrant or miscreant.

Attributes: I.Q. 2D6+13, M.E. 3D6, M.A. 3D6, P.S. 3D6, P.P.

3D6, P.E. 3D6+6, P.B. 1D6, Spd. 3D6.

Size: 6 to 8 feet (1.8 to 2.4 m) tall

Weight: 300 lbs (136 kg).

M.D.C.: 2D4×10 M.D.C.

Horror Factor: 11

P.P.E.: 1D4×10

Average Life Span: 1000+ years

Natural Abilities: Supernatural strength and endurance, very long lived, and heal 1D6×10 M.D.C. per 8 hour period.

Experience Level: Average 1D6+4

Psonic Powers: Have all sensitive powers plus automatic mind block, bio-manipulation and empathic transmission; considered to be master psonics.

Magic Powers: None.

Combat: Hand to Hand: Basic

Damage: Based on P.S.

Bonuses: +6 to save vs horror factor, +3 to save vs disease.

Vulnerabilities/Penalties: Take double damage from rune and holy weapons.

R.C.C. Skills:

Basic and Advanced Math (+20%)

Languages: Six of Choice (+15%)

Lore: Demons and Monsters (+10%)

Basic Electronics (+15%)

Mechanical Engineering (+15%)

Weapons Engineer (+20%)

Intelligence (+10%)

Concealment (+10%)

W.P.: Any two

Hand to Hand: Basic (never better than basic)

R.C.C. Related Skills: Select 12 other skills, but at least two must be from electrical and two from mechanical. Plus select two skills at level three, two at level seven, and one at levels ten and thirteen.

Communications: Any (+10%)

Domestic: Any

Electrical: Any (+15%)

Espionage: Any (+5%)

Mechanical: Any (+15%)

Medical: Any

Military: Any (+10%)

Physical: None

Pilot: Any (+10%)

Pilot Related: Any (+5%)

Rogue: Any

Science: Any (+10%)

Technical: Any (+20%)

W.P.: Any

Wilderness: None

Secondary Skills: The character also gets to select six skills from the previous list. These are additional areas of knowledge that do not get the advantage of the bonus listed in parentheses. All secondary skills start at the base skill level.

The Gene-Splicers

These mysterious master geneticists (fully described in the **Rifts Sourcebook Three: Mindwerks**) are also active in the Three Galaxies. The gene-splacers have mastered the sciences of genetics and gene-engineering, surpassing even the Transgalactic Empire (the leader in the Three Galaxies in genetic technology) and the Splugorth. In fact, the gene-splacers' abilities to create and remake beings is only matched by the magic of some of the most powerful ancient gods! Many legends have grown around these strange "mad doctors." Some fanatics think that they are the First, newly returned to remake their children in their image. The cosmo-knights know better and consider the gene-splacers to be one of their worst enemies. Some ancient writings suggest that the gene-splacers might be related to, or descended from *The One*, who tried to pervert the Cosmic Forge untold millennia ago. Others mention a race of beings from another dimension who tried to use the creatures of the Three Galaxies as their playthings, and who were expelled or destroyed by the early cosmo-knights. The truth may be any or none of these.

Gene-splacers operate in small groups of a dozen or less, usually only one or two, and they travel in cruiser-sized starships. These vessels don't have the firepower of most war vessels in the Three Galaxies, but they can outrun all but the fastest known ships, and can travel galactic distances at incredible speeds using a warp-space system not yet developed by known civilizations. Their stealth systems make them almost undetectable as well, so these villains can operate with relative impunity. They greatly fear cosmo-knights, phase adepts, second stage prometheans and beings of power, such as gods, adult dragons and demon lords. At the same time they are fascinated by these powerful beings and wish to map their genetic structures.

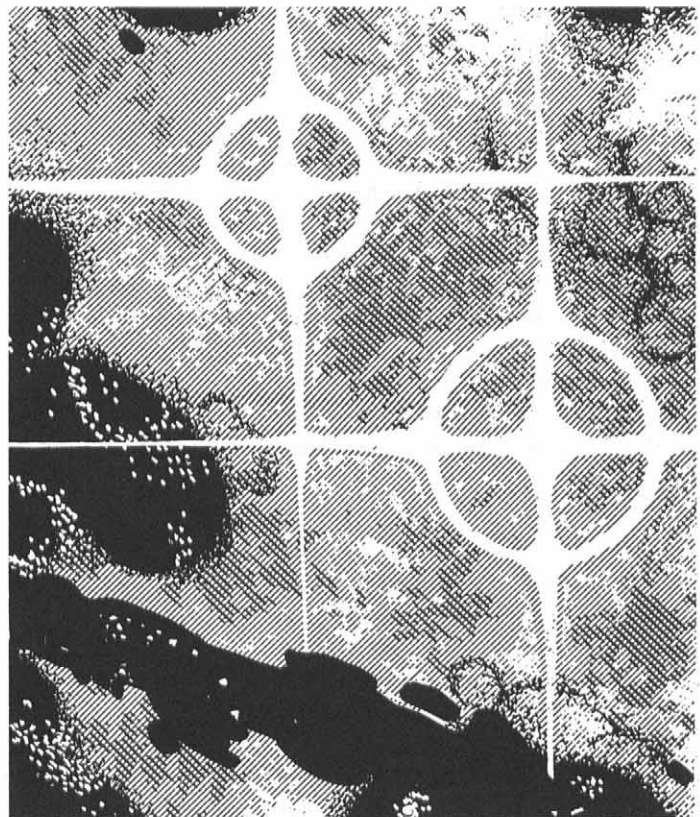

The Three Galaxies

The Three Galaxies contain over a thousand spacefaring races and perhaps two or three times that number in sentient races of lesser technological development. The two most powerful civilizations in the region are the *Consortium of Civilized Worlds* and the *Transgalactic Empire*. Of the two, the Transgalactic Empire is the most expansionist and warlike. The two cultures have clashed several times during their centuries-long history. Phase World is an independent planet and respected by everyone, including these two powerful forces.

Outlined below are some of the more important civilizations, races and organizations found within the Three Galaxies.

The Geography of the Three Galaxies

All the known civilizations in the Phase World universe come from one of three galaxies, known respectively as the Corkscrew, the Thundercloud and the Anvil. **The Corkscrew** is the largest galaxy, about 90,000 light years long and 2,000 light years thick. **The Thundercloud** is 20,000 light years away, and is “only” 30,000 light years long and 2,000 light years in thickness. On the other side, 30,000 light years away, is the **Anvil**, so called because it was once thought to be the hidden place of the Cosmic Forge; although serious exploration of the galaxy found no proof of this. The Anvil is the smallest galaxy in the group, 20,000 light years long and less than one thousand wide. The maximum distance from one tip of the Three Galaxies to the other is 170,000 light years. Neighboring galaxies are a considerable distance away. The closest one is 300,000 light years away; sporadic exploration of the other galaxies has occurred, but slowly, since there is so much to see in the local galaxy group.

Most of the population of the Three Galaxies is concentrated along the borders of the galaxies. Most inhabitable worlds (at least by humanoid standards) tend to exist away from the galactic “cores,” where older stars, black holes and less hospitable star phenomena occur more often. Travel between galaxies is faster than travel within a galaxy (*see the Starship section*): most star-faring cultures were able to colonize worlds in neighboring galaxies, or alongside the galactic “frontiers” rather than deep inside the cluttered interiors of the galaxy. In recent years, many exploratory missions have been sent into the interior of the galaxies, where they have discovered many strange and mysterious phenomena.

The “political” geography of the galaxy bears a funny resemblance to the political map of a planet, due to the fact that most inhabited planets occur on the “surface” of the galaxies. **The CCW** dominates about one-third of the Corkscrew, mostly on the galactic “North,” one-half of the Anvil, and a fifth of the Thundercloud, in terms of known inhabited worlds. **The Transgalactic Empire** controls another third of the Corkscrew, roughly to the “South” of the galaxy, and one-third each of the Anvil and Thundercloud galaxies; some worlds in the Thundercloud and Corkscrew, however, have successfully rebelled

against the Empire and now form the **Free World Council**. **The United Worlds of Warlock** dominates about one-fifth of the Anvil and a few worlds in the Corkscrew. No other civilization controls more than one-tenth of any of the galaxies and most only rule over one to six planets. **Phase World** is situated in the Corkscrew galaxy, between CCW and Imperial space.

The Three Galaxies contain billions of stars and planets. Only a small fraction of them can support life. Still, there are hundreds of thousands of inhabitable worlds, and only a small percentage of them have been colonized and developed.

The Demographics of the Three Galaxies

Nobody’s sure exactly how many sentient beings inhabit the three galaxies. The following population figures rely on planetary sensor reports, surveys from Exploration and Discovery Teams (EDTs), and census results. Many planets have not made an accurate census, so the total population figures are probably inaccurate. This is the information players are likely to have. Game Masters can adjust these numbers as they see fit.

Population of the Three Galaxies: *The Corkscrew* is the oldest and one of the more powerful of the galaxies. It has twelve trillion people. *The Thundercloud* and the *Anvil* galaxies have seven and six trillion inhabitants respectively, for a grand total of 25 trillion sentients among the three. Even these numbers mean that the Three Galaxies are relatively underpopulated. This is because many civilizations have been wiped out due to wars, plagues or astronomical disasters. Also, these estimates do not account for billions of sentients that live on worlds considered to be “uninhabitable” — uninhabitable for carbon-based life forms, that is. Contact with these very alien cultures is limited, so their exact numbers are unknown.

Humans

Humans make up a sizable percentage of the Three Galaxies’ population. About 12% of the total recorded population, out of 3,000+ sentient races or about 3 trillion people scattered over the Three Galaxies! This is over 300 times the population of Rifts Earth *before* the Great Cataclysm. The origins of humans in the Three Galaxies is unknown. Some legends claim that they came from another dimension. Others insist that humans evolved somewhere in the Three Galaxies, on a mythical planet called *Earth*. Their primary tongue is Galactic Trade Tongue Four, which is amazingly similar to English/American (characters with either language automatically know Galactic Trade Tongue Four at 50% plus any I.Q. bonuses, and can improve it normally). Seven human-inhabited worlds are named “Earth,” although none of them are similar to “true” Earth. It is also interesting to note that, in the Galactic Four language, a standard day is 24 hours, and a standard year is 365 days with an extra day added every four years!

It is commonly believed that these humans originated from Earth, probably an Earth that spawned an empire thousands of



years ago and which now lies lifeless and forgotten in some abandoned corner of space. Others think that human colonizers came from another dimension, and that their planet of origin is nowhere to be found in this universe. A few human supremacists insist that humankind is descended from the First Race, the mythical creators of the Cosmic Forge, but fanatics from hundreds of races make the same claim.

Humans are important members of all the major galactic civilizations, including the **Consortium of Civilized Worlds** and the **Transgalactic Empire** (described elsewhere). Their advanced technology, ingenuity and flexibility are well known throughout the Three Galaxies. Many races resent humankind's success and dislike them intensely.

Wolfen

To the surprise of some transdimensional visitors, one of the most prolific races of the Three Galaxies are wolfen, identical to the denizens of the Palladium world! Wolfen make up almost 10% of the Three Galaxies' total population. Most (90%) of all wolfen civilizations in the Three Galaxies can trace their origins to the **Ancient Wolfen Empire**, which originated on the planet they call *Motherhome*. Galactic Trade Tongue Three is identical to the Wolfen language, a measure of their influence in the Three Galaxies.

The inhabitants of Motherhome developed their technology independently and formed a budding star empire. Regrettably, the wolfen came on the losing end of a long war with the **Kreeghor Dominion**, now known as the Transgalactic Empire. The surviving remnants of the Wolfen Empire overthrew the royal family that had led them to disaster and re-established a Republic based on their old traditions. The Wolfen Republic joined the Consortium of Civilized Worlds, and wolfen spacemen, soldiers and traders are a common sight throughout the CCW. The wolfen worlds that were conquered by the kreeghor later became part of the kreeghor dominated Transgalactic Empire. Many wolfen serve the kreeghor willingly, while others have joined the freedom fighters that fight to regain their lost worlds, and to end the kreeghor's legacy of conquest.

The Kreeghor

This race dominates the **Transgalactic Empire**, the second largest civilization in the Three Galaxies. Additionally, many kreeghor chieftains control independent planets in many areas; there's even a small population of kreeghor renegades in the CCW (less than five million total). Kreeghor outside the Transgalactic Empire are usually found in the military and security industries, or on the other side of the law in the roles of pirate, criminal enforcer and other undesirables. The kreeghor account for roughly 8% of the total sentient population in the Three Galaxies.

Other Races

No other race makes up more than 3% of the total, and most represent much smaller percentages, considering that a race with 5 billion members would only amount to 0.02% of the total. However, many races have power and influence that goes far beyond their numbers.

Languages

There are over 10,000 major languages and almost a hundred times as many dialects and variations among the races of the Three Galaxies. Over the millennia, however, six major common or trade languages have been developed. These languages are known as the Galactic Trade Tongues (Trade for short). A person who knows any one of those languages has a good chance of making himself understood in most *civilized* areas. Knowing four or more trade languages guarantees being understood and communicating almost everywhere. Computerized translators exist, but are not always reliable (10% chance of mistranslating a sentence).

Trade One: This is the oldest trade tongue in existence, and is believed to have been one of the languages of the First Race. It is surprisingly easy to master by any air-breathing creatures, and even races with different means of communications. This is because many of the sounds also have equivalent hand (or other limb) signs and gestures. This language automatically has a +10% bonus to learn, in addition to any O.C.C. or I.Q. bonuses. Base skill is 50% plus any I.Q. bonuses and 5% per level of experience.

Trade Two: This language is favored by telepathic races, because it uses telepathy in addition to the spoken word. Without psychic abilities, much of the meaning of the language is lost. The psionic component allows users to bridge difficulties in speaking, and psychic sensitives pick it up very quickly. Characters with the psi-powers telepathy or empathy have a +20% bonus to learn Trade Two. Non-psychics have a -15% penalty. 50% plus any I.Q. bonuses and 5% per level of experience.

Trade Three: Trade Three is the wolfen language, slightly streamlined to reduce the guttural and growling elements common to the "classical" Wolfen language, but is otherwise identical. However, to make a good impression on wolfen speakers, it is necessary to emphasize the growls and whines of the original language. 50% plus any I.Q. bonuses and 5% per level of experience.

Trade Four: This language is clearly based on English/American. It has evolved enough to be different, however, with the addition of a number of technical terms, slang and foreign words (some of which are similar to other Earth languages like French, Chinese, Russian and Spanish). Normal English/American speakers automatically have Trade Four at 50% plus any I.Q. bonuses and 5% per level of experience.

Trade Five: Trade Five uses hisses, whistles and clicks for most words. It is favored by many reptilian and insectoid races. Humans and other air breathers can understand and learn Trade Five at no penalty, although they will retain a distinguishable "accent" that separates them from the races for which the language was originally created. Trade Five is commonly used by the kreeghor and seljuk races, and is usually the second language of the draconids.

40% plus 5% per level of experience.

Trade Six: This is the newest common language of the Three Galaxies and was developed by linguists of the CCW. Trade Six is a deliberate attempt at creating a universal language that can be used by most races of the Three Galaxies. To do this, each word and expression has two or three equivalents, two using sound and one using gestures, so a being who cannot make a

particular sound can replace it with an equivalent sound or gesture. The resulting language can be learned by all species without penalty, but the amount of different sounds and gestures that a speaker must know to understand another counterbalances this. Trade Six can be learned at no bonus or penalty by everyone. 45% +5% per level of experience.

Money and Trade

Space travel and galaxy-wide commerce have made it necessary to develop a universal medium of exchange. Although many planets still maintain their own form of coinage, every place with a starport accepts *Universal Trade Credits (UTC)* as money. Prices will change depending on simple supply or demand, government tariffs and taxes, and the legality of the merchandise in question. For example: A gun that can be bought on Phase World for 10,000 credits might cost ten times as much from the black markets of the Transgalactic Empire.

Note to player characters from other settings: Characters from Rifts Earth or other worlds will quickly discover that any credits, paper bills and other forms of exchange they brought

along are *useless* on Phase World and the other planets of the Three Galaxies. Barter and the sale of goods (or services) are the best way to get cash. **On Phase World**, Rifts characters with Earth credits can find Exchange Centers where they can trade their money for local cash. The exchange rate is brutally unfair, however: 10 Rifts Earth credits for every one Three Galaxies credit! The exchange centers then sell Rifts credits at the rate of five for every Three Galaxies credit. Since there aren't that many travelers going to and from Rifts Earth (this is beginning to change, a bit), that's the best characters can hope for. Selling and trading items is much more favorable and fair, giving people roughly the same amount of credits one would expect on Rifts Earth, providing one can find a buyer.

Splugorth credits, on the other hand, are accepted on a one-to-one basis, due to the incredible wealth and multidimensional connections of their ancient civilization. Gold, silver and bronze coins can be sold for their metallic content, which will always be less than what they were worth at their place of origin. Characters from medieval fantasy or 20th-century Earth settings will be at a financial disadvantage, unless they had some very valuable item to begin with.

The Consortium of Civilized Worlds

Also known as “The Consortium” and CCW.

Population Breakdown: 7 trillion sentient (estimated)

Humans 21%

Noro 20%

Wolfen 14%

Catyr 11%

Seljuks 10%

Others 24% (over 200 races, each of which comprises less than 1% of the total population)

The CCW is the largest and most influential civilization of the Three Galaxies, matched only by the Transgalactic Empire.

Several centuries ago, two budding federations of planets ran into each other. One was led by humans, the other by the Noro race. Fortunately, neither federation was interested in war and a peace treaty was signed between the two. Not too long afterwards, the Kreeghor Dominion (the predecessors of the Transgalactic Empire described later) started raiding the systems of the two collectives. A short but brutal space war later, the Noro and humans had joined forces and formed the Consortium of Civilized Worlds (CCW). The new alliance welcomed any advanced civilization that wished to join and who met the CCW's standards.

The Consortium's main goals are self-defense and peacekeeping. It rules through the principles of “enlightened self-interest,” and minimizes intrusions in the affairs of individual governments. Member planets are free to conduct their own governments, laws and societies as they see fit, as long as certain rights are preserved for all citizens. For example: Slavery is forbidden throughout the Consortium's planets and citizens cannot be imprisoned or executed without a trial. In theory, all Consortium

members are models of freedom and harmony. In practice, some worlds are ruled by exploitative dictatorships or other oppressive governments who use loopholes in the loose laws of the Consortium to oppress their people.

The Consortium comprises 231 member races and about 100 associated races spread over 5,000 inhabitable planets, thousands of space stations, bases and terraforming colonies on hostile worlds. “Member races” include any spacefaring species who control a planet belonging to the Consortium. Many of these species control only one planet and may have just learned to build simple spacecraft. Member races are given full citizenship rights and can conduct their own affairs as they see fit, as long as they respect the bylaws of the Consortium.

“Associated” races are alien species whose civilizations are technologically underdeveloped. A strict policy of non-interference is enforced on those worlds, limiting contact to a few small trading and scientific outposts. Such restrictions in trade and communication with other worlds is monitored and enforced by the Consortium Authority. Associated races are protected by the CCW's armed forces. When they reach the appropriate level of technology, they are invited to join the Consortium as full members, but are free to declare independence if they wish to do so.

CCW Government

The Consortium of Civilized Worlds is not as organized or controlled as a typical nation from 20th Century Earth. In some ways, it is similar to the American Confederacy during the Civil War; a loose alliance of “states” that has limited authority over the internal affairs of its members. All members of the Consortium must become signatories of the Civilization Compact. The

Compact is a pledge to follow a number of basic guidelines. If those guidelines are ignored, the signatory planet can be expelled from the Consortium — or its government may be removed by force.

The rules of the Civilization Compact are fairly simple. First, slavery is outlawed in all Consortium planets and territories. Slaves may not be owned, sold or transported in Consortium space and any slaves who are found there are considered to be free people and are automatically granted asylum by CCW authorities. Secondly, no Consortium member may engage in the conquest or colonization of other worlds without the consent of the Consortium at large. Violent conquest of other planets is expressly forbidden by the Compact and it cannot be carried out under any circumstances. Permission to colonize uninhabited worlds is usually granted, but such activities are monitored to ensure that the planet does not have intelligent races or even the potential to evolve intelligent species who may be compromised by the colonization process. The third clause of the Compact is that the signatory world must be represented by a planetary government. In special cases, only an area of a planet is granted membership to the Consortium and the rest of the world is left out of its jurisdiction. Finally, all signatories must pledge to respect a number of certain rights, including the right to property, the right to a fair trial, and the right to elect government representatives.

Those are the *basic rules* of the Consortium. They are not very detailed, since they are meant to cover many different races, cultures and civilizations. Like all laws, the Civilization Compact is often ignored, sidestepped, or broken. Several dozen worlds ruled by dictatorships or other exploitative and repressive governments are member of the Consortium. While slavery is illegal, in many places people become wage slaves, making barely enough to survive, or are eternally in debt to their employers. Some unscrupulous entrepreneurs quietly engage in limited slave trade outside of CCW space. Overall, however, most planets follow both the letter and the spirit of the Civilization Compact.

Each member world has its own form of government. Several hundred planets are also organized in sub-confederations of their own. The three biggest ones are the **Human Alliance**, the **Noro Federation** and the **Wolfen Republic**, each of which represents over a hundred planets and trillions of inhabitants.

There are three government branches in the Consortium of Civilized Worlds: The Consortium Congress, the Ministries, and the Galactic Courts. **The CCW Congress** proposes and approves laws and has representatives from all member planets. The number of Members of Congress (MCs) per planet is determined by the total population, economical, political and military contributions to the CCW and a number of other factors. The congress then elects a smaller number of Congressional Speakers who cannot exceed two hundred. It is they who do most of the debating on important issues. Laws are voted upon by the entire congress, with a two-thirds majority being needed to pass a law or proposal. Predictably, this system often makes it impossible to reach important decisions quickly.

The CCW Ministries are a number of political offices elected by representatives in a galactic-wide general election held every six Standard years. The Prime Minister is somewhat similar to a president, with the power to issue executive orders,

pass decrees and declare war. There are also about a dozen other Ministers, including Defense, Interplanetary Affairs, and Discovery and Development, but their decisions can be overruled by the Prime Minister. However, overruling the edicts of a Ministry is not done lightly and can be taken to the Congress for arbitration.

Finally, the **CCW Galactic Courts** enforce the laws of the Consortium. A large corps of judges and public attorneys is established through the Consortium planets. There are two courts of appeals and a supreme court in each sector. A *judicial sector* comprises 2-40 planets, depending on their size and population. These two courts can overturn laws they find unconstitutional.

There are also three government organizations that have influence and jurisdiction on all member planets and the associated worlds. They are the **Consortium Armed Forces (CAF)**, the **Galactic Security Agency (GSA)** and the **Treaty Violation Investigation Agency (TVIA)**.

The Consortium Armed Forces protect the spaceways and act as the equivalent of the Coast Guard. In addition to the space fleet, it has garrisons at every member planet to assist in matters of defense and security. The CAF cannot intervene in the domestic affairs of member worlds, unless ordered to do so by the Consortium. Intervention on a member planet can only be authorized by a two-thirds majority of the Consortium Congress. The CAF is also involved in the further exploration of the rest of the Three Galaxies and beyond. This exploration arm of the CAF is known as the *Discovery Corps*. Members of the Discovery Corps are among the best trained and famous members of the CAF. The majority are trained officers with years of experience in space travel and exploration.

Besides the CAF, the Consortium has a **Galactic Security Agency (GSA)** that serves a number of special functions. The agency acts as a *planetary police force* that is roughly the equivalent of the FBI. This police force investigates violations of the Civilization Compact, acts of espionage and terrorism, smuggling (especially the smuggling, sale and possession of harmful drugs and weapons), and other criminal activity that affects or involves more than one planet. The GSA also has a covert operations arm that conducts its own intelligence-gathering (spy) operations on other worlds. It is roughly equivalent to the CIA.

The Consortium enforces the Civilization Compact through the **Treaty Violation Investigation Agency (TVIA)**. The TVIA is charged with discovering any violations of the Civilization Compact and other treaties and agreements, both within the CCW and between the Consortium and other planetary governments. Their chief mission is to ensure that primitive peoples are not exploited, enslaved or defrauded by the citizens, businesses and governments of the CCW. Inspectors make periodic visits to associated planets and often place agents undercover among possible treaty violators. The TVIA has often been charged with being corrupt and subject to bribery and petty internal politics. As a result, the TVIA is now spending almost as much time policing itself as it is watching treaty violators.

The cosmo-knights are recognized by the CCW as a law-enforcement agency, as long as any and all cosmo-knights operating in CCW space are "Bonded Deputies." A bonded deputy is an authorized agent who knows and implements the laws of the Consortium. In general, cosmo-knights cannot intervene in domestic affairs unless they can prove that those accused of a

crime, be it the government, business or individual, were involved in violations of the Consortium's rules. The cosmoknights seem particularly adept at ferreting out such treachery (more on these knights later).

CCW Society

With hundreds of races and thousands of worlds, it is hard to generalize about the society of the CCW. There is one social distinction that cuts across all the differences in race, money and class: the difference between people who make their home in space, and those who don't. There are *Spacers*, often called "nomads," "vacuum addicts" and less complimentary things, and the *Groundsiders*, also referred to as "dirtsiders," "mud people" and other contemptuous nicknames. Spacers are typically ship crew members, explorers, soldiers and adventurers. They are not afraid of the vast universe they travel in, but they know and respect its deadliness. Groundsiders are people who are content with staying on one world and who only travel beyond its confines when they absolutely have to.

Spacers make up less than 10% of the Consortium's total population. Their importance is disproportionate to their size, however, because they help to keep commerce alive between the planets, defend them from invaders, and find new worlds to colonize. Their lives are so romanticized in movies and computer games that many children dream of becoming spacers when they grow up. At the same time, they are held in contempt by many adult groundsiders, who consider them to be shiftless vagabonds and glory hounds of an unscrupulous nature. The fact that they can be on one planet one day and one hundred light years away on the next has contributed to those sentiments. Many have a long history of leaving behind friends and lovers, unpaid debts, and causing trouble and running away rather than facing the consequences. By the same token, spacers have a rough code of honor, especially among themselves. These honorable spacers usually share the same disdain for the rogues who give them a bad name as the groundsiders. Meanwhile, most spacers look upon groundsiders as pathetic, narrow minded cowards, or wealthy snobs (land owners) who have a long history of unfairly blaming spacers for all their troubles and local crime. Most spacers feel the wealthy groundsiders are more likely to lie, cheat or steal from them.

Another common aspect of Consortium society is a general dislike for war. The noro culture has spared no effort to share with other races the consequences of mindless violence. Even the wolfen and seljuk races have come to recognize that war is only honorable if no other means of resolving a conflict are viable. This attitude has led to a general distrust of soldiers and warriors. Many people feel that soldiers cannot make important rational decisions, because they will be naturally inclined to be aggressive and start a war. What they don't realize is that most soldiers who have experienced the horrors of war first hand are often the strongest supporters of peaceful solutions. Still, on several planets soldiers are treated as coldly and belligerently as spacers.

This pacifistic tendency has frequently harmed the CCW, both in the battlefield and at the negotiating table. Fortunately, enough people recognize the need for a strong defensive force to keep the peace and maintain the law.

Foreign Affairs

The CCW's main rival is the **Transgalactic Empire** (described elsewhere). The members of the Consortium of Civilized Worlds realize that the kreeghor controlled empire will not rest until it dominates the Three Galaxies. In the news and entertainment of the Consortium, the Empire is presented as an evil, monster-ruled civilization where massacres and other atrocities are commonplace (an exaggeration, but with more than a grain of truth). The GSA covert operations branch spends most of its efforts secretly aiding the Free World Council and its freedom fighters as well as spies on the Empire regularly. By the same token, a number of Imperial spies also operate in the CCW, causing terrorism and unrest. Of course, both sides claim they are helping "freedom fighters" while their enemies support terrorists. Tensions remain high between these two collectives and many analysts believe that war is inevitable.

Besides the Transgalactic Empire, the **Splugorth** occupied worlds are another source of trouble. The CCW has no formal relations with about half of the Splugorth domains and is effectively in a state of war with two or three of them at any one time. Splugorth raids into Consortium space are a constant source of casualties and violence. Even Splugorth worlds that have established diplomatic ties with the CCW are not to be trusted and are constantly sending spies and saboteurs to harm CCW interests.

Relations with other worlds are a lot more amicable. The CCW and the **United Warlock Worlds** have several treaties of mutual assistance, trade and even defense in the event of a major galactic threat. The same is true for the **Paradise Federation**, and dozens of planetary governments. Often, independent worlds call in the CCW to arbitrate disputes, or to help them deal with disasters or invasions. The Consortium can be trusted not to take advantage of the situation and to be extremely fair. Many worlds fear that this reputation is undeserved, however, and that the CCW uses its trustworthy facade to slowly gain more power. Despite some problems with corruption and illegal operations of unscrupulous corporations, the former is more true than the latter.

Major Worlds of the CCW

Terra Prime: The oldest world populated by humans, Terra Prime (also known as "New Earth," "Terranova" or simply "Earth") is not the planet most humans remember as their place of origin. Legends and archeological discoveries seem to indicate that humans arrived in the Three Galaxies some 10,000 years ago, when several spaceships crashlanded on Terra Prime. They were probably explorers from another galaxy or maybe another dimension. The few ship fragments that have survived and subsequent legends are of no help in clarifying their origins. These humans were reduced to barbarism and had to relearn their technological knowledge and rebuild their civilization. Over the last 5,000 years they have been a spacefaring culture and have spread through the Three Galaxies. Terra Prime is the capital of the **Human Alliance**, one of the largest planetary collectives to join the CCW. The Human Alliance has its own government and armed forces, but it is also an active member of the Consortium. Many of the top Congressional leaders and ministers are natives of one of the planets of the Human Alliance.

Terra Prime is one of the most densely populated worlds in the Three Galaxies, with over 60 billion people crammed onto a

planet with roughly the same land area of Earth. Three semi-solid circles of artificial satellites and space stations ring the planet. Bustling colonies of several million people exist on four of the eleven planets of Terra Prime's solar system. Although none of those planets are capable of supporting human life, they are being slowly terraformed, as their mineral wealth is exploited.

Noro-Gor: Noro-Gor is the homeworld of the noro race. According to paleontologists, unlike many other races of the Three Galaxies, the noro evolved on this planet through natural evolution. Once a thriving industrial planet, Noro-Gor has been converted into a vacation home for the entire noro race; a place to visit and remember. Almost every member of the noro people visits the ancient homeworld at least once in his or her lifetime. Many make yearly trips there, usually followed by a stop at the ruins of Ironee, the devastated planet that acts as a monument to the horrors of war.

Motherhome: Motherhome is the place of origin for the wolfen race. Historians believe that thousands of wolfen tribesmen, perhaps the members of an entire nation, were Rifted to this planet several centuries ago. For some reason, mystic energy became a weak and erratic force on the planet shortly afterwards, and the wolfen forgot their reliance on magic and turned to technology instead. The powerful wolfen civilization emerged from this planet and spread throughout the Three Galaxies.

Today, much of Motherhome's three land masses are covered by verdant forests. The wolfen, after developing space travel, shut down all major industries and moved them to uninhabited planets or out into orbit. Then they reclaimed the land and regrew the forests. This is a favorite vacation spot for wolfen and nature-lovers alike.

Gemini One and Two: The Gemini planets are a galactic mystery. The two planets are locked in a freak binary orbit, one that normal physics cannot account for. By rights, the two planets should crash against each other as they perform their strange dance. Gemini One is a lush tropical planet, dominated by dinosaur-like races and the seljuk people. Gemini Two is a chaotic madhouse! A planet constantly battered by Rift activity and ley line storms. Scientists and magicians who have studied Gemini Two have determined that its P.P.E. intensity outstrips that of any known planet, including Rifts Earth! The Rift activity and terrible storms on this world are so severe that no native life forms have survived it. Archeological digs have discovered that all native life disappeared sixty million years ago. Now, the only inhabitants of Gemini Two are demons, supernatural beings, entities, the unfortunate D-Bee who is accidentally Rifted there, and those daring souls who brave the chaotic planet to do research (or who come to enlist the aid of monsters). Gemini One's life forms have become mega-damage beings, due to their P.P.E. rich environment, a side-effect of the proximity to their twin planet.

The Utopias: Some of the CCW's oldest and wealthiest planets are the most attractive places in the Three Galaxies. These planets, collectively known as the Utopias, have the highest living standards that technology can provide. Crime, disease and turmoil are all but nonexistent. The life expectancy of the Utopia's inhabitants is almost double the galactic average due to the most advanced health care system developed in the galaxy (humans in there have an average life span of 250+ years!). The cit-

ies have beautiful parks and wildlife preserves coexisting harmoniously with ultra-tech enclaves where the latest advances in entertainment can be found. All the Utopias have populations of 10 to 20+ billion citizens, but they manage their resources and environment in such a way that there is less apparent overpopulation than there was on 21st century Earth! The poorest citizen of a Utopia earns more money and enjoys more luxuries than many wealthy inhabitants on most other planets.

The source of the Utopias' wealth varies from planet to planet. Some have unique mineral resources (often located on other worlds in their star system), most of which are mined by robots or foreigners on work visas. The standards of living for non-citizens with work visas are usually much lower than those for citizens, but are still far better than the average, so there is usually a long waiting list for those jobs. Other Utopias are trading or communication centers. To prevent "contamination" from off-world sources, visitors are usually kept isolated from the Utopian societies as a whole.

There are 20 worlds that qualify as Utopias in the CCW. Eleven of them are dominated by humans, three by the noro and the rest are multiracial enclaves that roughly follow the demographics of the Consortium as a whole. Most people dream of one day retiring to these wonderful worlds. This goal is impossible to all but the most fortunate. All the Utopias have very strict immigration policies. Money helps; prospective immigrants are required to deposit between one million and one billion credits (this varies from applicant to applicant) in a planetary account before becoming citizens. If the citizen leaves the planet (or is deported), he cannot remove the money for 10 standard years! However, having money alone is not enough to become a member of the Utopian Society. Applicants with criminal records, no useful skills, and other problems may be denied entrance or required to make a significantly larger deposit. Visitors are constantly monitored and it is almost impossible to immigrate illegally into the Utopias.

Ironically enough, several famous adventurers and outlaws were born in a Utopia! These sons and daughters of the wealthy and powerful became bored or sick of their idyllic lives and left for the wilder areas of the Three Galaxies to find excitement, intrigue or fame.

CCW Characters & O.C.C.s

CAF Trooper O.C.C.

The Consortium Armed Forces Trooper is the everyday space soldier, roughly equivalent to Rifts Earth's Coalition grunt. CAF troopers are trained in both space and ground combat. Besides serving as combat troops, CAF troopers are expected to act as military police and peacekeepers, providing security aboard starships and space stations, and among the spaceways of CCW territory.



Attribute Requirements: P.S. and P.E. 10 or higher.

O.C.C. Skills:

- Language: Native at 98%
- Language: Trade Three, Four or Five (pick one) at 98%
- Language: Any two (+15%)
- Radio: Basic (+10%)
- Pilot Tank & APC (+15%)
- Pilot Contragravity Pack (+10%)
- Power Armor Combat: Basic
- Read Sensory Equipment (+10%)
- Weapon Systems (+15%)
- Climbing
- Running
- Swimming
- W.P. Energy Pistol
- W.P. Energy Rifle
- W.P. of choice
- Hand to Hand: Expert
- Hand to Hand: Expert can be changed to Martial Arts (or Assassin if an evil alignment) at the cost of one "other" skill.

O.C.C. Related Skills: Select 10 other skills. Plus select two additional skills at levels three and six, one at level nine, and one at level twelve. All new skills start at level one proficiency.

- Communications: Any (+5%)
- Domestic: Any
- Electrical: Any
- Espionage: Sniper, tracking and wilderness survival only.
- Mechanical: Any
- Medical: First Aid only
- Military: Any (+10%)
- Physical: Any
- Pilot: Any
- Pilot Related: Any (+10%)
- Rogue: Any
- Science: Basic and Advanced Math only
- Technical: Any (+5%)
- W.P.: Any
- Wilderness: Any (+5%)

Secondary Skills: The character also gets to select six secondary skills from the previous list. These are additional areas of knowledge that do not get the advantage of the bonus listed in parentheses. All secondary skills start at the base skill level. Also, skills are limited (any, only, none) as previously indicated in the list.

Standard Equipment: CAF battle armor, HI-10 laser pistol and HI-80 laser rifle. On a combat mission, they are assigned six grenades, survival knife, utility belt, hand computer/radio, survival kit and one extra weapon of choice.

Money: 1D4x1000 in savings. Standard salary is 2000 credits per month.

Cybernetics: None to start with. Most cultures in the Three Galaxies view cybernetic and bionic replacements with distaste and avoid them if possible.

CAF Fleet Officer O.C.C.

The officers of the Consortium Armed Forces Fleet Command (CAFFCO) are extensively trained in the art of leadership as well as a number of technical specialties. Since the CAF has to operate across galactic distances, often a long distance away from the established command structure, officers are expected to deal with many situations using their own initiative. People who hesitate or are unsure of themselves are shunted to rear-echelon "console jobs," and assigned to the less elite CAF Officers Corps (treat them as the regular CAF Trooper). The ones that graduate do so with a wide variety of skills and the ability to face the unexpected.

Theoretically, at least — no amount of training can predict how a Fleet Officer will deal with real life situations. Overall, however, CAFFCO officers are some of the most resourceful beings in the Three Galaxies. Most are able to command a starship, engage in ship to ship combat, survive in the wilderness, and/or conduct guerrilla warfare with improvised weapons. Many CAF-FCO graduates end up working as secret agents, or are assigned to elite Special Forces units. Their self-reliance gives them an edge when dealing with Transgalactic Empire Officers, who tend to follow orders more closely and have a strict regime of performance. On the other hand, in large-scale battles the Empire sometimes has the upper hand, because CAF officers tend to forget the "big picture."

Attribute Requirements: I.Q. 12, M.E. 12, and M.A. 11. High physical attributes are desirable but not mandatory.

O.C.C. Abilities and Bonuses: Through their extensive training and mental conditioning, Fleet Officers have +2 on initiative, +1 to resist horror factor, +1 to save vs psionics and mind control, and receives one extra attack per melee.

O.C.C. Skills:

Literate and Speaks two Galactic Trade Tongues at 98%

Two languages of choice (+20%)

Radio: Basic (+15%)

Radio: Scramblers (+15%)

Basic Electronics (+15%)

Detect Concealment (+15%)

Intelligence (+20%)

Paramedic (+15%)

Demolition (+10%)

Power Armor Combat: Basic

Fighter Pilot: Basic

W.P. Energy Pistol

W.P. Energy Rifle

One W.P. of choice

Hand to Hand: Expert

Hand to Hand: Expert can be changed to Martial Arts at the cost of one "other" skill (or Assassin if an evil alignment).

O.C.C. Related Skills: Select 10 other skills. Plus select two additional skills at levels three and six, and one at levels nine and twelve.

Communications: Any (+10%)

Domestic: Any

Electrical: Any (+5%)

Espionage: Any (+5%)

Mechanical: Any

Medical: Any (+5%)

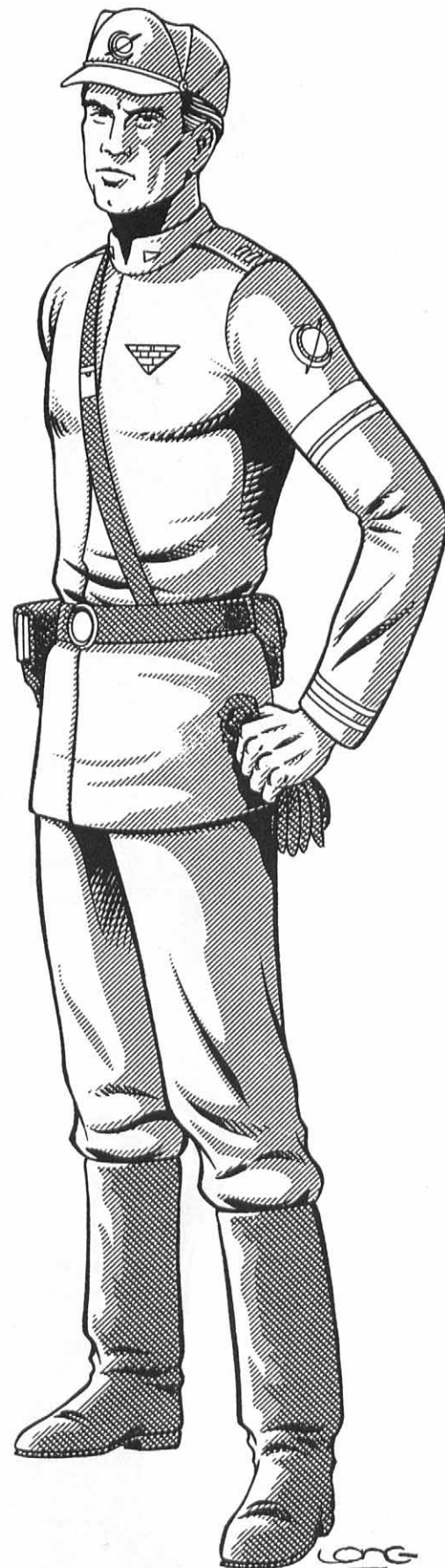

Military: Any (+5%)

Physical: Any (+5% where applicable)

Pilot: Any (+10%)

Pilot Related: Any (+10%)

Rogue: Any (+5%)
Science: Any
Technical: Any (+5%)
W.P.: Any
Wilderness: Any (+5%)

Secondary Skills: The character also gets to select five secondary skills from the previous list. These are additional areas of knowledge that do not get the advantage of the bonus listed in parentheses. All secondary skills start at the base skill level. Also, skills are limited to (any, only, none) as previously indicated in the list.

Standard Equipment: CAF battle armor, CAF uniform, HI-10 laser pistol and HI-80 laser rifle. On a combat mission, they are assigned six grenades, survival knife, utility belt, hand computer/radio, survival kit and one extra weapon of choice. Officers can also select a personal weapon.

Money: 3D6x100 credits.

Cybernetics: None to start with. Most civilizations of the Three Galaxies avoid cybernetics.

nine, and one at level twelve. All new skills start at level one proficiency.

Communications: Any (+10%)
Domestic: Any
Electrical: None
Espionage: Any (+5%)
Mechanical: None
Medical: First aid and paramedic only
Military: None
Physical: Any
Pilot: Any
Pilot Related: Any
Rogue: Any (+5%)
Science: Any (+5%)
Technical: Any (+5%)
W.P.: Any
Wilderness: None

TVIA Inspector O.C.C.

The Treaty Violation Investigation Agency is devoted to enforcing the Civilization Compact, a body of by laws that tries to preserve the basic rights of all sentient beings. Its agents have to deal with all kinds of crimes, including slavery, kidnapping, government corruption, genocide, tax evasion and terrorism. TVIA inspectors are often distrusted or even hated by normal citizens who believe the agency has more power than it deserves. The fact that many inspectors have been caught receiving bribes to look the other way does not help public opinion.

The inspectors are a combination of cop, spy, and lawyer. They cannot trust anybody, sometimes not even their own people. The TVIA often finds itself in conflict with the CAF when the military overlooks the rights of primitive peoples, CCW citizens, or the GSA when they run illegal operations within Consortium space. There is a lot of hostility between the three organizations.

Depending on the character, a TVIA inspector can be a dedicated defender of the Consortium, a petty government official, or a corrupt and dangerous individual.

Attribute Requirements: I.Q. 10 and M.A. 10 or higher.

O.C.C. Skills:

Three Trade Tongues of choice (+20%)
Consortium Law (+15%)
Intelligence (+10%)
Computer Operation (+10%)
Computer Programming (+10%)
Computer Hacking (+10%)
Basic Radio (+5%)
Surveillance Systems (+10%)
Criminal Sciences and Forensics (+10%)

W.P.: Two of Choice

Hand to Hand: Basic

Hand to Hand: Basic can be changed to Expert at the cost of one "other" skill, or to Martial Arts at the cost of two "other" skills.

O.C.C. Related Skills: Select seven other skills. Plus select two additional skills at level three, one at level six, one at level



Secondary Skills: The character also gets to select four other skills from the previous list. These are additional areas of knowledge that do not get the bonus listed in parentheses. All secondary skills start at the base skill level. Also, skills are limited to (any, only, none) as previously indicated in the list.

Standard Equipment: Hand computer, set of civilian clothes, HI-10 laser sidearm, TVIA badge and I.D., and light body armor.

Money: 4D6×100

Cybernetics: None to start with.

CAF Scientist O.C.C.

The CAF (especially the Discovery Corps) employs a large number of scientists aboard their ships. Since the Consortium often deals with unknown alien species, new and exotic weapon systems and other threats, even military specialists are often not enough to do the job. As a result, a whole class of scientist soldiers have been added to the military branch of the CAF. These military scientists are Warrant Officers, with the rank of a normal officer but not officially in charge of a military unit. They are trained in several scientific disciplines, with one area of specialization. This is in addition to basic military training.

In the Discovery Corps, the CAF scientists do planetary surveys, inspecting and appraising planets for their colonization potential or examining local species to determine their potential sentience, degree of civilization or likely pace of progress. They also study astronomical phenomena like supernovas and black holes. Sometimes, CAF scientists end up butting heads with conventional military men who often want to destroy potential dangers rather than contain and study them. Many scientists let their thirst for knowledge get the better of them, and they sometimes engage in dangerous studies or experiments. Most of the time, however, their work is very valuable to the Consortium.

Attribute Requirements: I.Q. 12 or higher.

O.C.C. Skills:

Computer Operation (+15%)

Literacy and fluent in four languages of choice (+15%)

Advanced Math (+20%)

Radio: Basic (+10%)

Basic Electronics (+10%)

One Science (specialty) (+25%)

First Aid (+10%)

W.P.: Energy Pistol

W.P.: Energy Rifle

Hand to Hand: Basic

Hand to Hand: Basic can be changed to Expert at the cost of one "other" skills, or Martial Arts or Assassin at the cost of two skills.

O.C.C. Related Skills: Select 12 other skills, but at least four must be selected from science. Plus select two additional skills at level three, two at level six, two at level nine, and one at level twelve. All new skills start at level one proficiency.

Communications: Any (+10%)

Domestic: Any (+5%)

Electrical: Any (+10%)

Espionage: Any

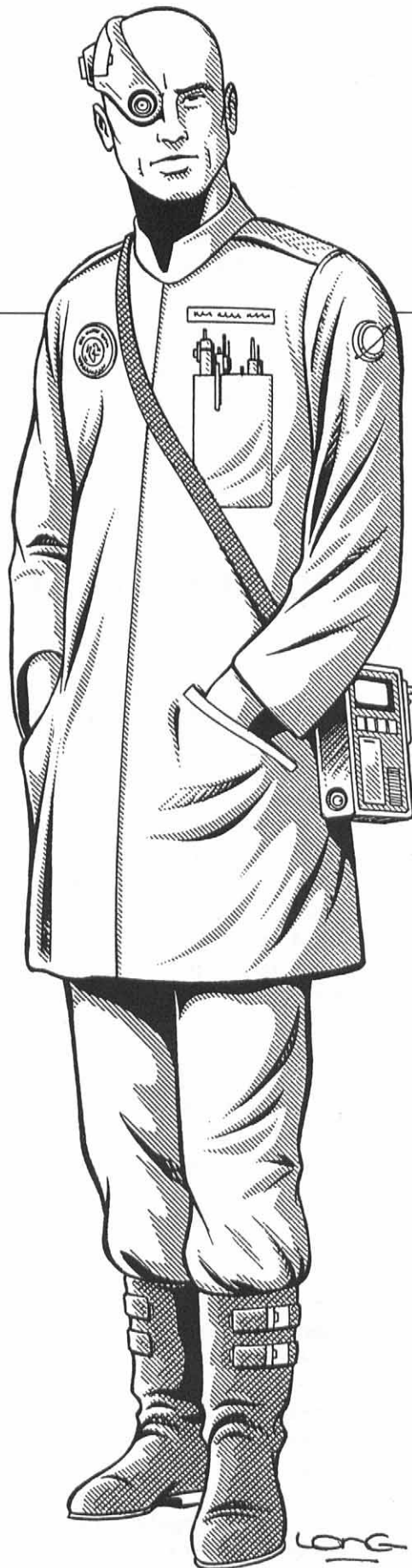

Mechanical: Any (+10%)
Medical: Any (+5%)
Military: Any (+5%)
Physical: Any, excluding acrobatics
Pilot: Any (+10%)
Pilot Related: Any (+10%)
Rogue: Computer Hacking only (+10%)
Science: Any (+20%)
Technical: Any (+15%)
W.P.: Any
Wilderness: Any

Secondary Skills: The character also gets to select six secondary skills at level one and another four at level four from the previous list. These are additional areas of knowledge that do not get the advantage of the bonus listed in parentheses. All secondary skills start at the base skill level. Also, skills are limited to (any, only, none) as previously indicated in the list.

Standard Equipment: Hand computer, portable translator, analyzer, hand communicator, CAF body armor, HI-10 laser sidearm, portable laboratory and first aid kit, as well as a dress uniform and a set of civilian clothing. They also have access to CAF military laboratories, computers, data files, and other research and science facilities.

Money: 2D6×100 credits.

Cybernetics: None.

Noro R.C.C.

The noro are an ancient and advanced race. While not as numerous as humans or Wolfen, they are an influential force in the CCW, and several other cultures of the Three Galaxies. The noro are thin and spindly humanoids, with oversized black eyes and long slender fingers. Their mouths and lower jaws are narrow in relation to the rest of their head, but not grotesquely so. They have six fingers on their hands and six toes on their feet. Instead of hair, their heads sport bony spikes of varying length that grow like hair. Some Noro affect a mohawk-like crest of spikes, while others “shave” them all off. In human terms, some noro can be very attractive, albeit outlandish. The race favors tunics or togas for ceremonial occasions and jumpsuits or bodysuits otherwise.

Their civilization originates from Noro-Gor, a planet located in the Corkscrew Galaxy. Their innate psionic powers resulted in the quick development of both psionic and non-psionic technologies. The fact that they could see the results of telekinesis, for example, gave them an early understanding of the laws of physics. The race advanced from the Stone Age to early spacefaring technology in an amazingly short time span of 5,000 Standard years. During this early phase, the dominant cultures on the planet were aggressive colonialists that were not much different from 19th Century Europeans.

Even before their first crude slower-than-light ships lifted them out of their planet’s atmosphere, the noro had discovered that they were not alone. One orbit away from them, another planet had developed life and its own civilization, a race known as the ironees. The planet Ironee was a colder world, but it had enough oxygen and water to sustain life. The ironees were actually an older race than the noro but they had developed more slowly and were roughly at the same level as early 20th Century Earth. The noro had captured early radio transmissions from

their neighbors and their powerful telescopes had discovered the marks of an industrial civilization. Facing overpopulation and political pressures, Zorak, one of the nation-states of the noro, concentrated on space technology, and sought to colonize Ironee. A few decades later, the spaceships of that nation were launched, carrying twenty army divisions.

The Ironee nations were given an ultimatum from orbit. Some relented and allowed the noro to land and occupy their countries.

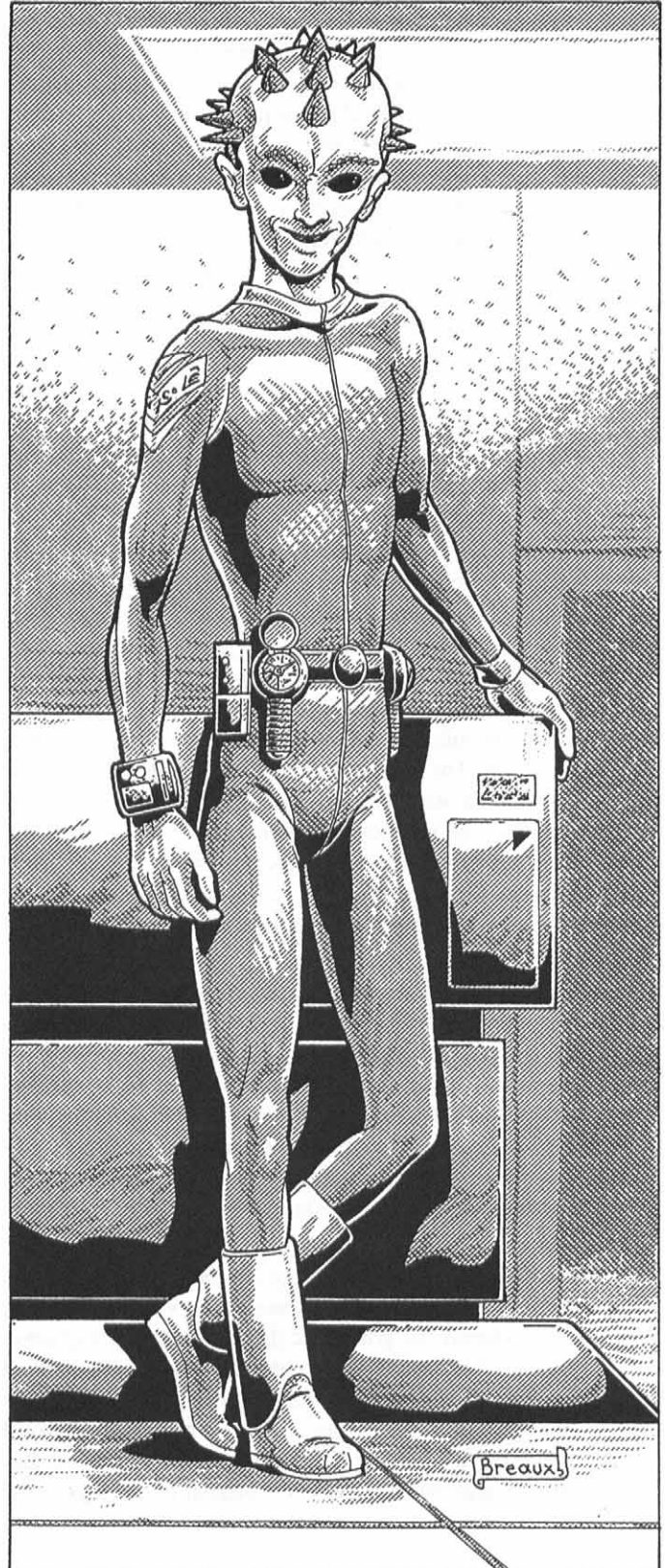

Others refused and sent their own primitive aircraft and armies to oppose the invaders. The Zorak's actions prompted other countries on Noro-Gor to launch their own expeditions, making alliances with some Ironees against both the Zorak and other Ironee countries. What followed was a savage world war.

What the noro didn't know was that several Ironee nations had been on the verge of discovering the atomic theory before the invasion. The long war prompted research for a doomsday weapon to stop the invaders. Several nations built and stockpiled atomic weapons. One dark dawn, they released hundreds of nuclear bombs on their enemies. Emboldened by quick victories, these nations resorted to massive nuclear bombings, missile launches, even the use of nuclear torpedoes and huge artillery shells. The noro, who had abandoned atomics long ago as an unsafe weapon, were unprepared. The armies they had stationed on the planet's surface were destroyed, slaughtering millions of their soldiers. But that was nothing compared to what the ironees did to themselves. The desperate aliens had no conception of how lethal their weapons were. Radiation clouds drifted along wind patterns, killing entire cities. Even in areas where no bombings had occurred, crops and livestock perished and people became ill and died for no apparent reason. The seas became barren as near misses and nuclear torpedoes contaminated the water. Believing that their enemies were using chemical weapons against them, the ironees fired off even more missiles at their enemies.

A few years later, Ironee had no living beings, save for a few highly mutated species living at the bottom of the oceans or crawling through the ruins of devastated cities. The ironees had succeeded in expelling the invaders, but destroyed themselves and made their planet unsuitable for supporting life in the process. The noro rulers responsible for the war tried to hide its results from their people, but psionic societies are notoriously bad at keeping secrets. The extermination of a sentient race shocked the noro culture to its core. All the older governments were brought down by the rally cry, "Never Again." To ensure their crimes would never be forgotten, every citizen has to make a pilgrimage to shrines built on the ruins of Ironee, where the psychic agonies of the war victims still remain vivid, three thousand years after the event.

According to several legends, the noro psychics who first visited the ruins of Ironee had a vision of the Cosmic Forge. In this vision, they received a message; they returned claiming that the fate of the noro was to be communicators, diplomats, and peace-bringers to the Three Galaxies. A religious movement, the Cult of the First Race, developed from the teachings of those psychics, and to this day, many mystics try to communicate with the spirits of the long-dead First Race and with the Cosmic Forge itself.

The noro developed a planetary government soon thereafter, one that kept the promise of never resorting to violent conquest. When they developed the gravitonic drive and started exploring worlds beyond their star, they colonized only uninhabited worlds. However, they discovered that total pacifism was impossible when a fleet of Kittani from a Splugorth-controlled world tried to conquer Noro-Gor. The noro defended themselves successfully and resurrected some of their martial technologies and skills with the understanding that they would be used only in self-defense.

As the noro worlds grew in number, some alien races tried to join their confederation. The noro allowed this with the understanding that the confederation did not allow forcible conquest and that all members were to be considered full citizens. A large human federation made contact with them and, after years of diplomatic talks and treaties, the two joined forces and the Consortium of Civilized Worlds was born.

The noro act as the conscience of the CCW. 60% of all Consortium Inspectors of the CCW Treaty Violation Investigation Agency (TVIA) are noro. They are determined to do their best to ensure that the tragedy of Ironee is never repeated. Many are active fighters against would-be conquerors, tyrants and proponents of genocides outside the CCW's range of control. Their Mystic Warriors are independent agents that have been discovered assisting the Freedom Fighters of the Transgalactic Empire, or working alongside Cosmo-knights, Phase Adepts, Undead Slayers and other champions. A small percentage of noro, however, have forsaken the ways of peace and exhibit an aggressive and dangerously selfish nature. They have become notorious rogues and outlaws.

Alignment: Any, but typically good.

Attributes: I.Q. 3D6+6, M.E. 3D6+10, M.A. 3D6+6, P.S. 3D6, P.P. 3D6, P.E. 3D6, P.B. 3D6, Spd. 3D6

Size: Seven to eight feet tall (2.1 to 2.4 m).

Weight: 180 to 240 pounds (82 to 109 kg).

M.D.C.: By armor or psionics only.

S.D.C./Hit Points: Standard, P.E. plus 1D6 per level of experience.

Horror Factor: None

P.P.E.: 4D6

Average Life Span: 250 years

Natural Abilities: Natural psionic abilities.

Psionic Powers: All Noro have the following powers: Empathy, object read, see aura, telepathy and mind block. The noro psychic and mystic warrior O.C.C.s have even more developed psionic powers.

I.S.P.: 1D4×10 plus M.E. attribute, plus 2D6 per level of experience. Considered to be major psionics.

Magic Powers: None. A few have learned the mystic arts; use appropriate O.C.C.s.

Combat: Normal; varies with skills.

Vulnerabilities/Penalties: None.

O.C.C.s: The Noro can choose from any O.C.C., excluding those that require heavy cybernetics or bionic conversions. Spacers, CAF soldiers, and psionic-related O.C.C.s (like the mind melter, noro psychic and noro mystic warrior) are the most common among adventurers.

Alliances and Allies: The noro work closely with humans. They find the aggressiveness of the wolfen and seljuk races to be unsettling, but explain it away, saying that those races haven't experienced the guilt of genocide first-hand.



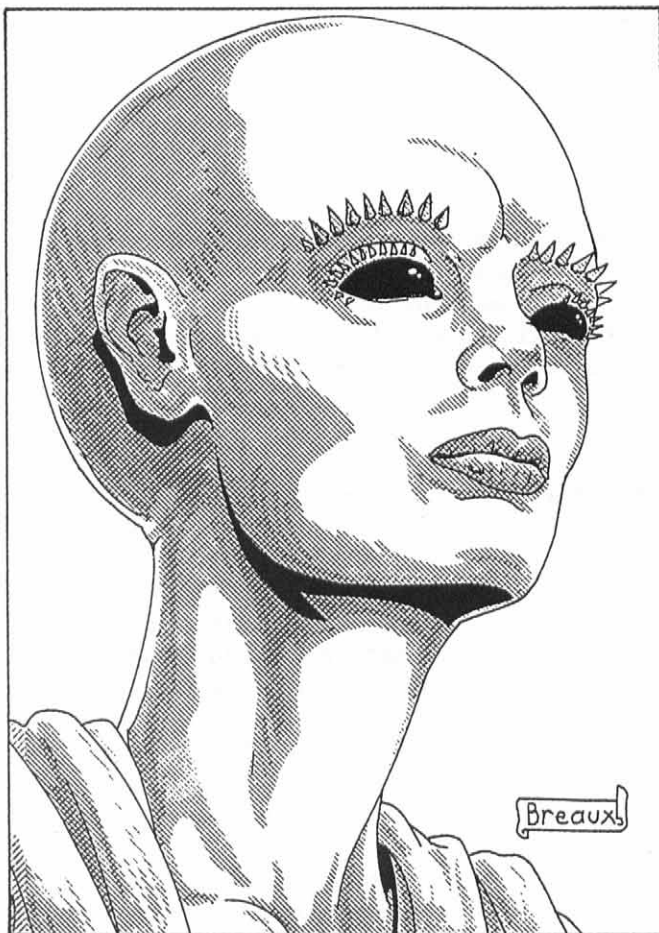

Noro Psychic O.C.C.

a.k.a. The Ghost-Makers

All noro have powerful psionic abilities. An elite few, however, have developed them to a much greater degree. There are many noro mind melters. These psychics are less flashy than the mind melters of Rifts Earth, but have a unique power: psionic control over energy entities. The noro psychics have developed a special affinity for "ghost" entities; energy beings that have been imprinted with the personality and memories of a deceased sentient being, but they can also summon and control tectonic, syphon and even possessing entities! Many psychics are also healers and counselors, while others become detectives and investigators who use their link to entities to solve crimes.

Noro psychics are instrumental in reminding their race of the crimes of the past, and preventing them from making the same mistakes again. A number of them reside full-time on Ironee, where they summon ghosts to recreate the tragedy of the invasion and eventual self-destruction of the ironees. Many others serve in the CAF as officers, secret agents, soldiers and medical officers.

Attribute Requirements: M.E. 14 or higher. This O.C.C. is generally restricted to members of the noro race, although other highly psionic races and individuals could have an equivalent class (GM's call), or be trained as honorary Ghost-Makers.

O.C.C. Abilities and Bonuses:

1. **Psionic Powers:** At first level, the psychic has all normal noro powers, empathy, object read, see aura, telepathy and mind block, plus the following:

- Exorcism
- Induce sleep
- Psychic diagnosis
- Psychic surgery
- Empathic Transmission
- Hypnotic Suggestion
- Mind Block Auto-Defense

Also select two psi-abilities from the healing, sensitive and physical categories.

At second level, the psychic can select a total of two powers from the Sensitive, Healing and Physical categories, and one from the Super category (except mind wipe, psi-sword and possess others).

At third level and beyond, the psychic can select two powers from any category (with the above exceptions).

2. **Summon and Control Entities:** Psychics have the special power of summoning (or perhaps creating) energy entities. It costs 10 I.S.P. to summon a haunting entity/ghost, 20 I.S.P. to summon a syphon entity, 30 I.S.P. to summon a tectonic entity, and 40 I.S.P. to summon a possessing entity. Tectonic and possessing entities will resist the summons and control and can make saves vs psionics to break free every minute (4 melee rounds) after it was summoned. The psychic can use I.S.P. to reduce their saving throws at the rate of 1 I.S.P. per -1 to the save, per attempt.

Some typical uses of this entity control include:

Speak with the Dead: By summoning a haunting entity to an area marked with strong psychic residues (the scene of a crime or lethal accident, for example), the psychic can cause the ghost to be imprinted with the memories of the victim and hold limited conversations with it, or make the ghost(s) re-enact the events that occurred there. Keep in mind that haunting entities have a very low I.Q. and will be limited by the strongest emotions or memories permeating the area (see **Rifts Conversion Book One** for a complete description of entities).

Combat: A possessing or tectonic entity can be commanded to fight for the noro psychic. If the fight can be potentially lethal to the entity, it saves to break free at +3, but most noro would never jeopardize the life of even a possessing entity that's under his or her control.

Therapy/Interrogation: Haunting entities can be used to help relieve psychological traumas in a patient, or even to discover secrets the subject does not wish to reveal. To do this, the psychic must first successfully use telepathy on the subject, and then summon the entity and create a psychic connection between it and the person. However, there is no guarantee that the information imprinted by the ghost will be what the psychic was looking for, or whether or not the impressions reflect the character's real problems/past or whether they are deep-rooted fears or anxieties without any rational basis.

3. **I.S.P.:** 3D6x10 plus M.E. number. Plus 11 I.S.P. per level of experience.

4. **Bonuses:** +2 to save vs psionics, +3 to save vs any type of mind control, and +3 to save vs horror factor.

O.C.C. Skills:

- Basic and Advanced Math (+20%)
- Basic Radio (+15%)
- Computer Operation (+15%)
- Biology (+10%)

Pathology (+10%)

Medical Doctor (+15%)

Criminal Sciences and Forensics (+15%)

Hand to Hand combat can be selected as an "other" skill as follows: Basic counts as one skill selection, Expert as two, Martial Arts three and Assassin counts as four skill selections.

O.C.C. Related Skills: Select ten other skills. Plus select three additional skills at level three, two at level six, and one at levels nine and twelve. All new skills start at level one proficiency.

Communications: Any (+5%)

Domestic: Any

Electrical: Any

Espionage: Any (+5%)

Mechanical: None

Medical: Any (+10%)

Military: None

Physical: Any

Pilot: Any

Pilot Related: Any

Rogue: Streetwise only (+5%)

Science: Any (+5%)

Technical: Any (+15%)

W.P.: Any

Wilderness: Any

Secondary Skills: Select six secondary skills from the previous list. These are additional areas of knowledge that do not get the advantage of the bonus listed in parentheses. All secondary skills start at the base skill level. Also, skills are limited to (any, only, none) as previously indicated in the list.

Standard Equipment: Full medical kit (including a phase-tech med-kit), forensics kit, hand-held computer, sample holder, chemical analyzer and radio-phone. Adventurer/military psychics will also have one sidearm and light body armor.

Money: 4D6×1000 credits.

Cybernetics: None.

Noro Mystic Warrior O.C.C.

A few noro keep alive their race's warrior heritage. Shunned by many of their fellow noro, they claim that a race without warriors risks extermination. These characters use their considerable psionic powers for combat and have developed abilities that surpass those of mind-melters and other psionic entities. Many mystic warriors work for the CAF, while others act as independent Bonded Deputies, bounty hunters or even vigilantes. Several have joined the rebellion against the Transgalactic Empire, a handful have become villains of the worst magnitude.

Noro who feel the calling to the warrior's life start developing offensive psionic powers early during their adolescence. In many families, these signs are suppressed or discouraged by the young noro's parents and friends, but in many cases that only results in more eagerness to learn them. If the budding warrior finds a teacher, he or she will develop unique powers that only a mystic

warrior can develop. They are also trained in the use of the psionic power armor developed by the noro race.

Mystic warriors often team-up with cosmo-knights, phase adepts, undead slayers and other champions of the forces of light. A few have traveled to other dimensions (including Rifts Earth) in search of new challenges.

Attribute Requirements: M.E. 14 or higher. A high P.S., P.P. and P.E. are desirable but not required.

O.C.C. Abilities and Bonuses:

1. Bio-feedback: By channeling their psionic energies inward, mystic warriors become able to withstand a great deal of punishment and can ignore pain and wounds. By spending 1 I.S.P., the character gains a bonus of 3D6×10 S.D.C. and a +20% to survive coma/death.

2. Mind Blast: Mystic warriors can generate super-powerful blasts of psionic energy that are more powerful than normal mind bolts, although they have less range. These bolts inflict 1D6 M.D. for every 5 I.S.P. spent on them, to a maximum of 2D6 M.D. plus 1D6 M.D. per level of experience (i.e., a first level mystic warrior could fire a blast doing 3D6 M.D., a second level warrior could do 4D6, etc.). Range: 300 feet (91.5 m).

3. Psionics Powers: At level one, the character automatically has empathy, object read, see aura, telepathy and mind block. Plus select two powers from each of the four power categories, with the exception of mind wipe, psi-sword, and possess others (available at third level and beyond). At second level, the character gets to select two powers from the sensitive, healing and physical powers, and one from the super category. At third level and beyond, select two powers from any category without exceptions.

4. I.S.P.: 4D6×10 plus the character's M.E. attribute, plus he gains 3D6 I.S.P. per level of experience.

5. Bonuses: +1 on initiative, +4 to save vs horror factor and +2 to save vs all forms of mind control.

O.C.C. Skills:

Three languages of choice (+15%)

Monster and Demon Lore (+10%)

Piloting skill of choice (+10%)

Power Armor Combat: Basic

W.P.: Energy Pistol

W.P. Energy Rifle

Hand to Hand: Expert

Hand to Hand: Expert can be changed to Martial Arts (or assassin if evil) at the cost of one "other" skill.

O.C.C. Related Skills: Select 8 other skills. Plus select two at level three, and one at levels six, nine and twelve. All new skills start at level one proficiency.

Communications: Any

Domestic: Any

Electrical: Basic only

Espionage: None

Mechanical: None

Medical: First aid and paramedic only

Military: None

Physical: Any

Pilot: Any (+5%)

Pilot Related: Any (+5%)

Rogue: Any (+6%)

Science: Any
Technical: Any (+5%)
W.P.: Any
Wilderness: Any

Secondary Skills: The character also gets to select six secondary skills. These are additional areas of knowledge that do not get the advantage of the bonus listed in parentheses. All secondary skills start at the base skill level. Also, skills are limited to (any, only, none) as previously indicated in the list.

Standard Equipment: Psi-gun of choice, suit of psionic power armor, hand computer, light body armor, and traveling clothes.

Money: 2D6×100 credits.

Cybernetics: None, and will never consent to them.

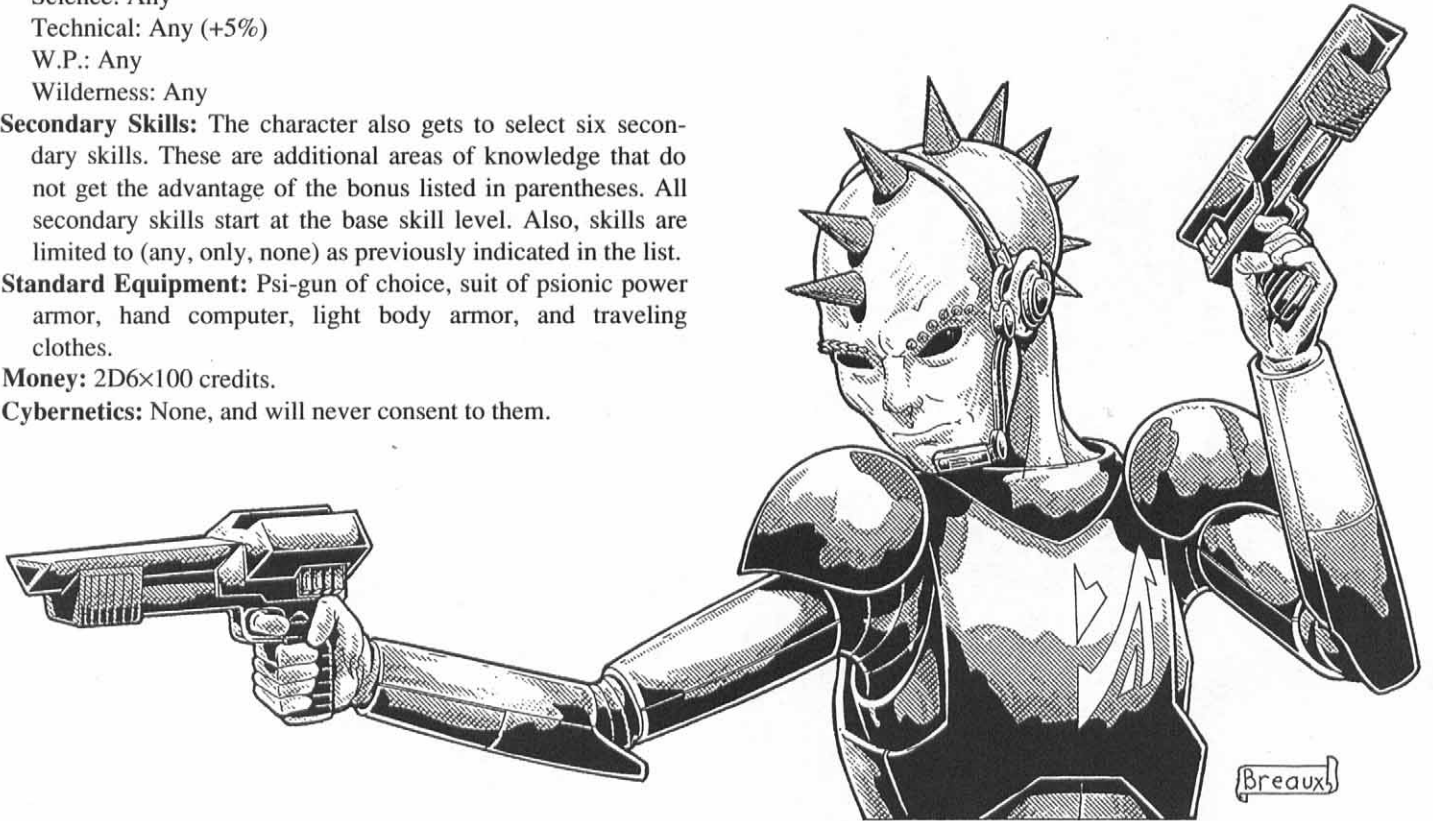

Space Wolfen R.C.C.

The wolfen are a race of large canine humanoids. Despite their animal appearance, they are highly intelligent and have built an advanced civilization. They have a reputation as one of the most intelligent, cunning and resourceful species in the Three Galaxies. Like humans, wolfen are found almost everywhere and are respected and admired as often as they are hated, envied and feared. The wolfen civilization emphasizes the virtues of honor, valor and strength, both individually, and as a whole society. Their organization and political system are reminiscent of the ancient Roman Empire of Earth, and their language and some terms bear a strong resemblance to Latin equivalents. Dimensional travelers who have noted these similarities are not sure whether this was a case of parallel evolution or (more likely) a case of transdimensional pollination: perhaps a group of Romans visited the wolfen's original homeworld millennia ago, or vice versa.

Not too long ago, the Wolfen Empire aspired to unify an entire galaxy under its rule. However, the appearance of the Consortium of Civilized Worlds, Transgalactic Empire and other circumstances have changed their dreams of wolfen hegemony. In the CCW, the wolfen are accepted as one of the leading partners of a galactic-spanning confederation. In the Transgalactic Empire, they are an important client race, but one that is subordinate to the true masters of that Empire, the kreeghor race. Different factions within the wolfen culture have dealt with these two rivals in a number of ways. Many have come to appreciate the wisdom of forging an alliance with other races and accepting them as equals. The CCW, they believe, is a stronger and more long-lasting creation than any previous wolfen-dominated nation

has been. Another faction still firmly believes in wolfen supremacy; this attitude ranges from simple pride in wolfen accomplishments ("I only buy wolfen equipment; nothing else is as good.") to outright xenophobia ("Humans? Cowards who hide behind their stupid sense of humor. Noro? Weirdos who use their dishonorable powers. Kreeghor? Insane monsters. The only trustworthy beings are our fellow wolfen."). A few wolfen supremacists plot for the day when their race will assume their "rightful" place of ultimate power in the Three Galaxies. These sentiments occur among wolfen in both the CCW and in the Transgalactic Empire, which results in convoluted political intrigue. For example, Imperial Wolfen supremacists may funnel aid to the Freedom Fighters, but only to help promote their cause, and they will not hesitate to betray the rebels if this will help them earn more power in the Empire.

Most wolfen, however, have adapted to the new order, and are model citizens of the CCW. Loyal wolfen have a strong presence in the Consortium Armed Forces at every level and have contributed many scientists, engineers, diplomats and other notable people.

Alignment: Any, but tend toward principled and aberrant; both alignments have a strong personal code of honor for which the wolfen are famous.

Attributes: I.Q. 3D6, M.E. 3D6, M.A. 2D6, P.S. 4D6+1, P.P. 3D6, P.E. 3D6, P.B. 3D6, Spd. 4D6

Size: 7 to 9 feet tall (2.1 to 2.7 m).

Weight: 350 to 500 pounds (157.5 to 225 kg).

M.D.C.: By armor or magic only.

S.D.C./Hit Points: 30 S.D.C. plus those gained from O.C.C.s and physical skills.



Horror Factor: 12

P.P.E.: 3D6

Average Life Span: 120+ years. Ultra-tech health care has more than doubled the wolfen's natural life span.

Natural Abilities: Nightvision 40 ft (12.2 m), keen color vision, superior sense of smell and hearing, recognize common/known smells 50% +3% per level of experience. Track by smell alone 20% +4% per level of experience.

Experience Level: Varies.

Psionic Powers: Standard; basically same as humans.

Magic Powers: Only if a magic O.C.C. is selected.

Combat: Two hand to hand attacks without combat training, or one plus those gained from hand to hand combat and/or boxing.

Damage: Bite does 2D4 S.D.C. damage and claws do 1D6 S.D.C. damage plus P.S. bonus.

Bonuses: +2 on initiative, and one extra attack per melee, in addition to attribute, O.C.C. and skill bonuses.

Vulnerabilities/Penalties: None; roughly equivalent to humans in environmental requirements, diet and chemical tolerances.

O.C.C.s: Virtually any non-restricted O.C.C.; they lean towards wilderness and highly skilled warrior occupations, or to science. Many famous cosmo-knights were (and are) wolfen; their strict code of honor seems to fit in well with the goals of the Cosmic Forge. The wolfen abandoned the practice of magic long ago; only wolfen native to the Warlock Federation are likely to belong to a magic O.C.C.

Alliances and Allies: The wolfen of the CCW work closely with humans and the seljuk, both of whom they admire greatly. Most wolfen believe that humans pay too little attention to matters of honor, but have learned to forgive them for their

“immature behavior.” The seljuk's battle prowess and sense of honor are greatly respected by the wolfen, and vice versa. On the other hand, most wolfen dislike and distrust the noro, although they accept them as equals.

The wolfen of the CCW and those of the Transgalactic Empire hate each other with a passion. Each side considers the other to be traitors to their race. Even Freedom Fighters have to deal with this intolerance: CCW wolfen consider rebels against the Empire to be “lost pups returning to the fold,” something that the rebel wolfen resent, but are willing to accept to get help from their CCW brothers and sympathizers.

Weapons and Armor: Vary with O.C.C.; most wolfen favor ancient styles of weapons and W.P.s. Even millennia after becoming a spacefaring race, wolfen officials carry ceremonial swords as a badge of office (and many of those swords are not-so-ceremonial vibro-blades and phase swords).

Wolfen Quatoria O.C.C.

a.k.a. The Star Marshals

Quatoria is an archaic Wolfen term meaning “officer of the Law.” In the pre-industrial days of the Wolfen Empire, Quatoria were law enforcement officers. In remote areas, a Quatoria often acted as marshal, judge, jury, executioner and grave digger. When the Wolfen Empire expanded to the stars, the Quatoria became special law enforcers sent to the most remote and unruly areas of the known universe where they would be the only symbols of the law. To ensure the Quatoria survived their hazardous duties, they were altered through cybernetics and bionics. Bone implants, artificial muscles and wired reflexes transformed them into super-powerful creatures. The Quatoria retain their Wolfen appearance, but much of their internal organs and bones have been replaced by powerful machines. A number of cybernetic implants make Quatoria perfect spies and detectives, but the hardware is secondary to the extensive training and indoctrination they receive. They are dedicated (some would say fanatical) law-enforcers and have little sympathy for the criminal element. Whenever the “dead or alive” option exists, most Quatoria prefer to bring them back dead — it saves the taxpayers the cost of a trial. Abuses often occur and innocent people have been killed by some overzealous Quatoria, but since they usually operate in the more lawless corners of the Three Galaxies, such abuses often go unreported or unnoticed.

The Quatoria are an elite law-enforcement agency. Since the Wolfen Empire joined the CCW, all Quatoria have become Bonded Deputies with authority to enforce the CCW's law throughout all the planets. However, they often pursue criminals outside the borders of the Consortium's control. In those areas, the only backing they can expect is what their guns and their fists can provide.

Quatoria often work undercover, pretending to be pirates, smugglers or bounty hunters. Some have developed extensive contacts with the underworld, and have made a number of allies and friends among the seedier circles of the CCW and independent worlds.

Attribute Requirements: M.E. 13 or higher. Physical attributes are altered by advanced bionic and cybernetic implants.

Alignment: Usually good or selfish, although some Quatoria have become aberrant and a few renegades are pure evil.

O.C.C. Abilities and Bonuses:

1. Bionic Conversion: The Quatoria's bodies are enhanced through advanced bionics and cybernetic implants. They voluntarily sacrifice their humanity to serve their people. They are both admired and feared for this. **Note:** The bionic systems used to enhance the Quatoria are state-of-the-art and are at least a century ahead of anything that can be achieved anywhere on Rifts Earth, with the possible exception of Atlantis!



The bionic body has P.P. 22, P.S. 40 (robotics) and Spd of 88 (60 mph/96 km).

- 2. M.D.C.:** Although Quatoria look like normal Wolfen (usually on the large side), they have become M.D.C. beings through their bionic systems. Body: 350 M.D.C. Hands: 25 M.D.C. each. Arms: 75 M.D.C. each. Legs: 120 M.D.C. each. Head: 90 M.D.C.
- 3. Living shell:** Through advanced surgical procedures, the skin, fur and some of the muscle structure of the Quatoria volunteer are grafted onto a cybernetic endo-skeleton. This allows the Quatoria to lead a normal life and hide his bionic features and abilities. Taking more than 100 S.D.C. of damage (1 M.D.C.) will tear up enough of the living shell to reveal the cyborg body beneath. This revelation usually has a horror factor of 14!
- 4. Nano-Machine Regeneration:** Stored in a special compartment deep inside the cyborg is a nano-machine repair kit. Millions of virus-sized robots are released to repair the damage on both the flesh and metal components of the Quatoria whenever they are required. These repairs restore 2D6 M.D.C. or 3D6 S.D.C. per hour to all damaged parts. The nano-machines can only work for 8 hours before requiring 16 hours of recharge time. The metal and flesh components of the Quatoria can also be repaired or healed through conventional medicine and mechanics (the flesh parts can be healed by magic or psionics too, but at half the normal level because the cybernetics interferes with the magic and psychic powers).
- 5. Psionic Electromagnetic dampers:** The Quatoria has electronic anti-psionic fields installed. These use advanced technologies developed by the noro race and give the Quatoria a +6 bonus to resist psionics.
- 6. Sensory Suite:** Highly advanced sensors throughout the entire visual, auditory and radar spectrum have been installed into the Quatoria. These include standard multi-optic eyes, ultra-ear, sound filtration system, sensor system (includes heat, motion, radiation and radar detection, 500 feet/152 m range), and built-in radar (5 mile range, 75% chance of identifying targets, location and speed/direction of travel). It is almost impossible to sneak up on the Quatoria; a typical action of the "star marshals" is to shoot or disable an enemy behind them without even turning around.
- 7. Other bionic features:** Bionic lung with gas filter and oxygen storage cell, language translator, built-in loudspeaker and radio receiver and transmitter.
- 8. Combat Bonuses:** +2 on initiative, +5 to strike and parry, +4 to dodge, +2 to pull punch, +2 to roll with impact, +6 to save vs psionics and +2 to save vs horror factor (includes the P.P. 22 bonus and optic/sensor considerations). Add one additional attack per melee.
- 9. Damage:** The advanced bionic system allows the Quatoria to inflict mega-damage with his bare hands!
Restrained Punch — 1D6+25 S.D.C.
Full Strength Punch — 1D6 M.D.
Power Punch — 2D6 M.D. (counts as 2 melee attacks)
Head Butt — 1D4 M.D.
Kick — 1D8 M.D.
Jump Kick/Leap Attack — 3D4 M.D. (counts as 2 melee attacks)
Judo Style Throw/Flip — 1D4 M.D.

Full Speed Ram/Body Block — 1D4 M.D. (counts as 2 melee attacks)

O.C.C. Skills: Include special bonuses through bionic senses.

Radio: Basic (+10%)

Surveillance Systems (+10%)

Basic Electronics (+10%)

Detect Ambush (+15%)

Detect Concealment (+15%)

Detect Ambush (+15%)

Intelligence (+5%)

Pilot: Small Starship (+10%)

W.P.: Energy Pistol

W.P.: Energy Rifle

Hand to Hand: Expert

Hand to Hand: Expert can be changed to Martial Arts (or Assassin if of aberrant alignment) at the cost of one "other" skill.

O.C.C. Related Skills: Select six other skills, plus select two at level four, two at level seven, and one at levels ten and twelve. All new skills start at level one proficiency.

Communications: Any (+5%)

Domestic: Any

Electrical: Any

Espionage: Any (+5%)

Mechanical: None

Medical: First aid and paramedic only (+5%)

Military: Any

Physical: Any

Pilot: Any (+10%)

Pilot Related: Any (+10%)

Rogue: Any (+5%)

Science: Any

Technical: Any (+5%)

W.P.: Any

Wilderness: Any

Secondary Skills: The character also gets to select five secondary skills. These are additional areas of knowledge that do not get the advantage of the bonus listed in parentheses. All secondary skills start at the base skill level. Also, skills are limited (any, only, none) as previously indicated in the list.

Standard Equipment: Heavy energy pistol of choice, heavy energy rifle, six concussion grenades, hand computer with criminal files database, suit of mega-damage body armor.

Money: 2D6×100 credits.

Cybernetics: May have an additional 1D4 cybernetic systems in addition to the ones listed above!

Catyr R.C.C.

The catyr are red-skinned humanoids, slightly taller than the average human, with metallic-colored gold or bronze hair. Their native planet, Catyr-Ra, orbits a binary star system, and is exposed to radiation levels that would be lethal to many other species. Somehow, life thrived under these harsh conditions and the catyr became the dominant species. They developed technology that eventually carried them to the stars. Like most races of the Three Galaxies, the catyr developed science and technology but not magic.



The catyrs met a human planetary collective before the foundation of the Consortium. At first, the encounters resulted in violence and a short but savage war was fought for control of a mineral-rich planet. Diplomacy carried the day, however, and soon the catyr had forged a number of alliances with other civilizations. Their homeworld was invited to join the CCW several centuries ago and its population unanimously accepted the membership.

Although they have been staunch supporters of the CCW, the catyr are often regarded with some fear by other species. This is because their bodies emit low levels of radiation that can hurt most normal beings after prolonged exposure and because they are supernaturally strong and tough, they are able to kill a normal human with an accidental punch or slap. As a result, catyrs tend to stay in their own communities, or become spacers, soldiers, and mercenaries; groups that are also feared and shunned by many.

As a race, the catyr's temperament is surprisingly similar to humans. Their culture, beliefs and psychology are so close to those of humankind that some researchers now believe that the catyr are actually genetically-altered humans that were placed on that hostile planet for unknown reasons. Some suspect the gene-splicers are responsible, but there is no evidence to support such supposition. Meanwhile, some catyr contend that maybe humans are genetically-altered catyrs who were seeded across the Megaverse.

Alignment: Any.

Attributes: I.Q. 3D6, M.E. 3D6, M.A. 3D6, P.S. 6D6+6, P.P. 4D6+6, P.E. 4D6+6, P.B. 4D6, Spd. 4D6. P.S. and P.E. are considered to be supernatural.

Size: Six to seven feet (1.8 to 2.1 m) tall.

Weight: 160 to 350 lbs (72.5 to 159 kg).

M.D.C.: Natural M.D.C. creatures. 4D6×10+40 M.D.C., plus 2D6 per level of experience.

Horror Factor: 10

P.P.E.: 3D6

Average Life Span: 200 years.

Natural Abilities: Invulnerable to radiation, can see into the ultraviolet range of light (night vision 200 feet/61 m), bio-regeneration 2D6 M.D.C. per hour.

Psionic Powers: None. Cannot develop psionics.

Magic Powers: None. A few catyrs learn magic, but their culture has almost no magical knowledge.

O.C.C.s: The catyr can select most O.C.C.s, except those that require psionics or mystic knowledge. Common O.C.C.s include spacer, runner, CAF trooper or officer, pirate, tracer, and other men-at-arms, as well as other adventurers and scholars. Only a small percentage (one-tenth of one percent of all adventurers) learns magic as a mystic or ley line walker.

Money: Per O.C.C.

Cybernetics: Per O.C.C.

Seljuk R.C.C.

This race developed on Gemini One, a planet where dinosaurs were the predominant life form. The archeological record shows that these dinosaurs were identical to Earth's dinosaurs from the Jurassic and Cretaceous eras! Parallel evolution, or Rift activity? Nobody knows. Scientists have discovered that, about fifty million years ago, the planet was irradiated by a powerful P.P.E. storm, possibly as the result of a mega-Rift opening somewhere on Gemini's twin planet which is famous for its Rift activity (described previously). This irradiation produced a powerful change on all life forms larger than a mouse. They all became supernatural, mega-damage creatures! The few species that were not affected in this way perished, unable to compete against comparatively invulnerable creatures. Periodically, the planet was also hit by freak hurricanes and ley line storms, often depositing supernatural predators and monsters. The struggle for survival was of incredible ferocity, as both animals and plants mutated rapidly in the P.P.E. energies, as well as other forms of radiation that came through the Rifts.

From this savage world emerged one dominant species, descended from the dominant predator of the planet: Tyrannosaurus Rex. As a result of sudden mutations and evolution, the T-Rex branched into several species. One became the dreaded Terror Lizard (see the Monsters and Animals Section). A different sub-species became smaller and smarter, a fast and deadly pack hunter with long, dexterous hands. This sub-species evolved into an intelligent species that would eventually become the seljuk race. The seljuk learned to make tools and simple weapons, just as their shamans learned magic; some of their race legends claim that dragons from the Rifts taught them these secrets.

The seljuk did something unique in the history of magic-using races. Not long after the development of their first cities, a circle of powerful magicians tried to protect their planet from the savage ley line storms that would ravage and destroy entire cities. These storms could lay to waste in minutes what had taken the seljuk generations to build. In a legendary ceremony, to this day honored in seljuk religious gatherings, the magicians turned the planet's rich P.P.E. energy against itself, sealing the planet

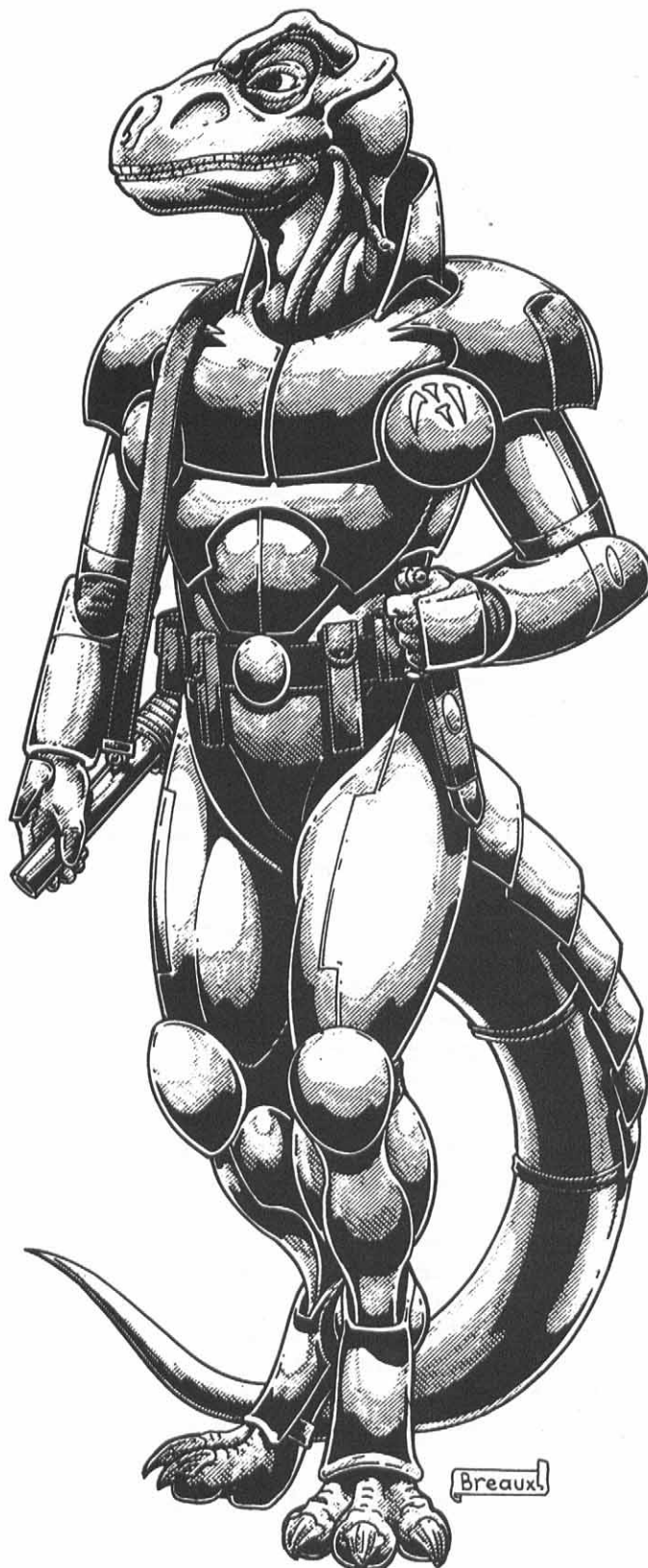

from Rift and ley line activity. The price for the ceremony was severe, and was paid for by every member of the seljuk race. Only a permanent sacrifice of every person's P.P.E. capacity was able to power the mystical ceremony and the day the Rifts were banished from the planet also marked the last day any Seljuk could work magic. This race, potentially one of the most powerful sorcerers in the Megaverse, became unable to use spells to tally or any other magic.

The tales of this ceremony claim that even this mighty ritual would have failed without the intervention of the Cosmic Forge. The sorcerers and shamans conducting it received a communication from this entity/artifact at a crucial part of the ritual and found their magical powers doubling for a very brief time, just long enough to complete the spell. All the mystics and magicians present caught a glimpse of the Forge itself in all its power and majesty, and to this day the fabled artifact is an important part of most seljuk religions.

The end of the Time of Chaos (as it became known) enabled the seljuk to continue developing in more mundane and conventional ways. The seljuk were able to channel their predatory instincts into the hunt for knowledge. The people went through many different stages, punctuated by wars, natural disasters, and political upheaval. The dominant culture was one of defending warriors. Fighters who considered it a duty and a privilege to protect the weak and helpless, and who saw war as a necessary evil. This culture was able to convert and influence the rest and eventually the whole planet was united under a Protectorate with a parliamentary government. By the time they were visited by an alien starship, they had developed a civilization on the verge of developing a star drive.

The visitors were fortunately benign, noro explorers who established peaceful relations with the seljuk. Although intimidated at first by the fearsome race, the noro soon discovered that they were honorable and reasonable beings eager to learn more about the universe around them. Trade was established between the Noro Federation and the Seljuk Protectorate. Soon afterward, the seljuk had purchased and mastered the secrets of the gravity drive and started colonizing planets of their own. The Seljuk Protectorate decided to join the Consortium of Civilized Worlds when the Kreeghor Empire started encroaching on its space. They realized that they could not defeat the Kreeghor Empire alone; many of their planets had already surrendered to the dreaded enemy rather than risk obliteration. Like the wolfen before them, they asked the CCW for help and joined that community of planets.

The seljuk culture could be described as chivalric. Honor and courage are respected above all else. Renegades who break the code are exiled, or even executed, depending on the severity of their crimes. Many have risen to prominent posts in the Consortium where they practice the same ideals of honorable conduct. For a chivalric seljuk to completely respect another person, that person must show bravery and conviction — not brute strength and foolish bravado. It is the courage and conviction of the mind and spirit that most impresses them. A person who stands up for what he believes is a hero in the eyes of the seljuk.

Alignment: Any

Attributes: I.Q. 3D6, M.E. 3D6+4, M.A. 3D6+2, P.S. 2D6+40, P.P. 4D6, P.E. 2D6+18, P.B. 3D6, Spd. 6D6; supernatural strength and endurance.

Size: 9 to 12 feet tall (2.7 to 3.6 m).

Weight: 600 to 1,000 lbs (272 to 453 kg).

M.D.C.: 3D6×10+80, plus 2D6 per level of experience.

Horror Factor: 11

P.P.E.: 1D4

Average Life Span: 150 years

Natural Abilities: Keen sense of smell and sharp color vision.

They can leap 15 feet (4.6 m) from a standing still position.

Furthermore, they take half damage from M.D.C fire and energy attacks (including magical attacks) and regenerate 1D6×10 M.D.C. per hour.

Psionic Powers: Average, about the same as humans.

Magic Powers: None. Can never learn or use magic — no P.P.E.

Combat: As per skill, plus add one attack per melee.

Damage: Claws do an additional 2D6 M.D. in hand to hand combat.

Bonuses: +1 to save vs horror factor, +3 to save vs magic and have no value to P.P.E. vampires or as sacrificial lambs in magic rituals.

O.C.C.s: Seljuks can select most O.C.C.s, including most Consortium and Empire-related ones. They can even be a psychic R.C.C.'s like the mind melter and burster (but not psi-stalker). Their main limitation is magic; no magical O.C.C. can be taken by this race. For experience purposes, use the seljuk R.C.C. experience table or the appropriate O.C.C. table, whichever is higher.

Alliances and Allies: The seljuk get along very well with most races of the Consortium. Those in the Empire also have the respect of the Kreeghor race.

The Transgalactic Empire

Population Breakdown: 6 trillion total (estimated)

Kreeghor 25%

Humans 15%

Machine People 10%

Wolfen 9%

Silhouette 6%

Monros 5%

Noro 5%

Others 25%

The Transgalactic Empire is an autocratic civilization ruled by the kreeghor, a warlike race of inhuman creatures. The kreeghor are the dominant race of the Transgalactic Empire, but not the only one with power or influence over the Empire. Unlike the CCW, the Transgalactic Empire has a policy of expansion, armed conquest and slavery. As a result, many of its subjects are in open rebellion against it.

The kreeghor were the result of Splugorth bio-engineering, a former slave race that rose against its tormentors and was able to overthrow them, but only by becoming as savage and blood-thirsty as their one-time masters. The kreeghor have spread

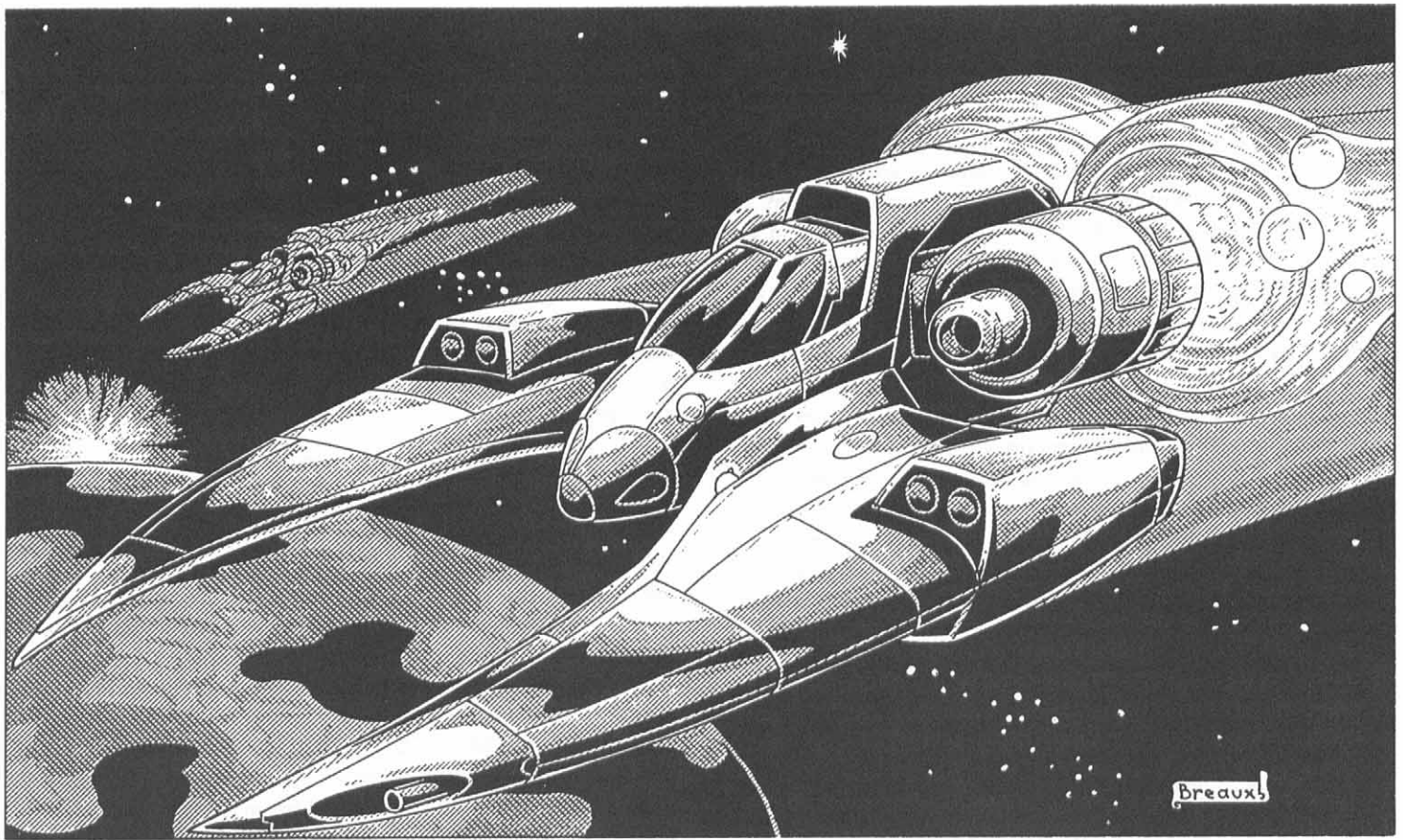

through the Three Galaxies like a plague, conquering and colonizing planets at a frenzied pace. Those who dared to oppose them were destroyed or defeated and enslaved. At first, the kreeghor constantly engaged in the routine enslavement or genocide of other races, but as they matured as an intergalactic force, they realized that those policies would eventually lead to their destruction. The kreeghor then decided to accept worthy conquered races as “near equals” who could play a role in their Empire. A brutal war with the Wolfen Empire proved them worthy of this new policy. Instead of destroying the wolfen, they conquered them. The kreeghor praised their enemies’ martial spirit and offered good terms to any planet that surrendered. Many wolfen warriors decided to join forces with the kreeghor and turned against their own kind. This was especially true of clans or tribes that had grievances against the wolfen royal family, and who decided revenge was worth the price of betrayal. To this day, millions of wolfen warriors are the kreeghor’s allies. The same tactic was applied against several human-inhabited worlds and now humans are an important part of the empire as well.

The Transgalactic Empire’s golden age came to an end with the formation of the Consortium of Civilized Worlds (CCW). In the CCW, the kreeghor found an enemy that could not be easily beaten. Realizing that all-out war would destroy both civilizations, the Empire sued for peace. An uneasy peace treaty was signed, but centuries of resentment remains strong. More recently, the Transgalactic Empire has been rocked by civil war. A popular uprising on the planet of Good Hope (description to follow) soon spread to several conquered worlds and became an organized, well-armed rebellion. Instead of conquering new worlds, the kreeghor and their minions now have to recapture dozens of rebellious planets. The war goes on, with no end in sight.

Government

The Transgalactic Empire is a monarchy, ruled by the kreeghor emperor and the Royal Family. The Royal “Family” is made up of members of the Royal Kreeghor sub-species, a super-powerful variant of the kreeghor race. A few heroic or famous subjects of the Empire, both kreeghor and non-kreeghor, are sometimes “adopted” into the Royal Family. Royal Family members command the military and disdain all other forms of public service as “button pushers” unworthy of true warriors. They are granted large estates and farms worked by slave labor and live off the rents produced by them. The emperor has a Privy Council made up of the most powerful members of the Royal Family. The Privy Council has 6 to 12 members and each of them is second to the Emperor in authority.

Below the royal family are a number of Ministries, usually filled by non-kreeghor public servants (mostly humans and wolfen). The Ministers take care of the bureaucracy and administrative duties, such as tax-collecting, funding, and other tasks. Their proposals have to be approved by the Emperor, or one of the members of the Privy Council. Corruption is rife among the ministers. The kreeghor don’t pay as much attention to business affairs as they should, so most ministers skim money off the top and hide it beneath layers of bureaucracy. As long as the imperial machinery is kept running, the kreeghor do not mind some petty theft. However, should these bureaucrats cross their masters, the ministers can be removed and killed at the whim of the Emperor.

Planetary holdings are controlled by military governors answerable only to the Royal Family. These governors can be of any race, but all are chosen for their loyalty to the Empire, and are fanatical pro-imperialists with little tolerance for dissent. The

rest of the government is run by the military which fulfills the role of policing, tax-collecting and other government tasks.

Society

The Empire runs on a very simple system: Subjects can do what they want as long as they don't interfere with the Empire, break the law, or willingly or accidentally get in the way of somebody more important than they. On the surface, life in the Transgalactic Empire is not too different from that of other worlds. People go to their jobs, start their own businesses, and lead seemingly normal lives. Closer examination reveals that things are not as normal as they seem.

First of all, there is always a visible military presence in the lives of the Imperial subjects. Armed patrols can be seen on all major streets. Propaganda posters proclaiming war victories can be seen on every street corner, and movies and television have clearly militaristic undertones and zealous, patriotic programming. A sizable percentage of the population is directly involved in the military. Every town, city and village has an armed garrison. Every child born in the Empire has seen tanks rolling down the streets or military jets flying overhead.

Also, there is always an atmosphere of fear. If a person says the wrong thing in public, he might get a visit from an armed squad. Most of the time, the person is just intimidated and threatened by the soldiers, but sometimes the victim just disappears, never to be seen again. Any criticism of the Empire is met with censorship, repression and violence. The Royal Family has the right of life and death over all subjects (there are no citizens in the Empire, only "subjects" without legal rights). If a Royal likes your home, he can evict you and move in himself. These privileges are not enforced often, but each injustice reminds people that they have no rights or defenses against their powerful masters. Imperial propaganda tries to counter all of this with claims that the Empire has brought peace and prosperity to all member planets. Many people believe in this and are actually dedicated to the betterment of the Empire. Those who disagree are afraid of speaking their minds.

Slavery is legal in the Transgalactic Empire. Convicted criminals, captives of war and the descendants of slaves make up most of the slave population. Parents can sell their children into slavery if they want to. "I'll sell you off if you don't behave," is a threat commonly heard in many poor households. People can even sell themselves off to pay debts. A slave can buy his freedom if he manages to save enough money. However, this is exceedingly difficult because they don't get wages, but slaves can save up tips and gratuities. Slaves have very few rights. Owners can kill or abuse them with relative impunity. Escaped slaves guilty of treason, are tortured or executed when captured. Most wealthy households have one or more slaves — some have dozens. Entire factories, mining operations, farms and plantations are often run on slave labor.

Racism is rampant in most parts of the Transgalactic Empire. The kreeghor and a few "worthy" races, such as the *machine people*, the *silhouette* and the *wolfen*, enjoy more privileges than others. These people are rarely mistreated by the authorities, are always given the benefit of the doubt, and usually win any legal trouble they have with members of other species. A slave's word against one of these races is dismissed entirely. Humans, the second largest race after the kreeghor, are treated as second-class citizens unless they are members of the armed forces.

The laws of the Transgalactic Empire are simple and brutal. Suspects are assumed to be guilty until proven innocent. The authorities can search any premises without need for warrants, and arrest suspects on the flimsiest of evidence. Those convicted of minor offenses (petty theft, littering, etc.) are fined heavily, often the equivalent of several years' worth of pay. If the person cannot pay, they have to work it off in labor, performing such duties as garbage collecting and street sweeping. Thieves, con-men and political dissenters are condemned to hard labor, erecting buildings or working in mines, or sold into slavery. Murderers, rapists, and convicted traitors are either executed (often by torture) or condemned to one of the Hellholes, brutal prisons deliberately designed to be worse than death (described elsewhere).

The Free World Council

About a hundred years ago, a popular revolt exploded on the planet of Good Hope. The planet, populated mostly by humans and wolfen, had been suffering under a tyrannical human governor. Among other things, the governor seized the offices of a local news service and had every employee executed by torture for the crime of reporting rumors of corruption in the local government. This last crime sparked a riot. The governor ordered the army to take a tank company and, in his words, "Drown those rioters in their own blood." Rather than slaughter thousands of innocent people, a number of human and wolfen soldiers rebelled against their officers and, supported by an angry mob, attacked the Governor's Palace with tanks and artillery pieces, reducing it to burning rubble. An army lieutenant, Michael Klass, found himself leading a revolution. Klass was a popular officer who had also proven himself to be a compassionate and fair man. Soldiers, civilians and escaped slaves joined his cause. He also proved to be a gifted military leader and he was able to defeat the loyalist forces with surprising ease. In a daring stroke, Klass led a commando team to capture the powerful war satellites orbiting the planet. This successful, surprise attack gave them control over the orbital death dealers and also provided the rebels with a 24 vessel fleet that was captured along with the satellites. Once the entire planet was under the rebels control, Klass publicly denounced the Emperor as a ruthless tyrant and asked all members of the Transgalactic Empire to rise against their oppressors.

News of this successful uprising spread throughout the Empire despite efforts to suppress all reports coming from Good Hope. For the first time in centuries, a world had successfully fought and defeated the Imperial Army! A military expedition dispatched to recapture the planet was delayed by strikes, sabotage and riots on several other worlds. The governors of those planets reacted to these rebellious outbreaks with brutality, slaughtering thousands of people. These measures backfired by stirring more discontent. Then the unthinkable happened again. Instead of being content with their winning back of Good Hope, the rebel fleet, consisting both of the captured ships and additional merchant ships outfitted with weapons and armor, swooped down on planets locked in conflict and helped the local rebels overthrow the governments there as well. Two other planets were freed from the grip of the Transgalactic Empire.

Finally, a large fleet was sent against the three rebel planets. To the surprise of the kreeghor, the fleet was met by a huge armada of ships, including pirates and smugglers who had been

convinced by Klass to join the rebellion. Other ships had been provided by Splugorth-controlled worlds, always happy to cause chaos among their former slaves. Among the rebels also stood a dozen cosmo-knights, each equivalent to a small starship by themselves! A massive space battle was fought with inconclusive results. The rebels suffered enormous losses, but the Imperial fleet was decimated and had to withdraw without finishing its mission — the planets and the rebels were battered but remained free.

Since then, the rebels have managed to capture and hold on to over two dozen planets. There is open rebellion and warfare on dozens of other worlds. Several space routes are war zones and any ship flying through risks being destroyed by one side or the other. Klass was assassinated thirty years after the revolution, but his granddaughter *Rachel Klass* has carried on the struggle. The freedom fighters call themselves the **Free World Council**. Their goal is to defend liberated worlds, carry the revolution to other oppressed planets, and establish a democratic government. The Free World Council has attracted many different people to its banner. Most of them are dedicated revolutionaries, people who have suffered under the Empire and now want revenge. Others are men and women who will not stand for kreeghor domination. Some have joined out of greed and ambition, hoping to use the revolution to gain power, fame and wealth. Many criminals facing the wrath of the Empire joined the rebellion out of sheer self-preservation.

So far, the rebellion has not managed to make a serious dent in the kreeghor's holdings; only a couple dozen worlds compared with the Transgalactic Empire's thousands of planets. However, the fact that the Empire has not been able to crush the freedom fighters is an insufferable offense to the kreeghor and the rebels are a constant thorn in their side.

Foreign Affairs

In the eyes of the Transgalactic Empire, there are two kinds of foreign powers, enemies who are to be defeated by force of arms and enemies who are to be deceived by diplomacy. The Splugorth-controlled worlds are among the former, and the Consortium of Civilized Worlds and the United Worlds of Warlock are among the latter. In any dealings with other worlds, the Transgalactic Empire will try to strengthen itself by undermining everybody else. At first, they had no skilled diplomats, since the kreeghor is a warrior race with little use for peaceful arts and trades. In more recent times however, a well-trained diplomatic corps (made up mostly of non-kreeghor representatives) has been developed. Now, Imperial Ambassadors are received by all major civilizations in the Three Galaxies. However, their goals for conquest and intergalactic domination remain unchanged. The kreeghor have simply become more devious at achieving them.

Major Worlds of the Transgalactic Empire

The Imperial Homeworld: The planet Kreeghor-Tet is the capital of the Transgalactic Empire. This is where the Emperor and most of the Royal Family members reside. It is also the most heavily defended planet in the Three Galaxies. This is because the Homeworld has been targeted by Splugorth attacks as recently as two hundred years ago, when a fleet of over 2,000 Kit-

tani ships made a suicide run toward the planet. The Imperial palace towers over a sprawling city of 50 million, bracketed by giant space cannons too big to be mounted even on the largest starships. These huge guns are able to melt a ship into slag before it gets into orbit!

Good Hope: This planet is the capital of the rebellion. It used to be a wealthy and advanced trading world, but decades of war has converted it into a giant military camp filled with grim people dedicated to continuing their struggle for freedom. Good Hope is surrounded by planetary and satellite defenses and is the base of operations for a rebel fleet with more than 200 ships.

The Hellholes — Prison Worlds: This is the common name given to the Kreeghor Empire's prison planets. The Hellholes are designed to break the spirits of their prisoners. All kinds of abuses and indignities are heaped on the inmates. Suicide and murder are common among the prisoners. The smallest infraction is punished with torture through mental and physical means. Each Hellhole is different from the others. Some employ the inmates in mining operations, others have them plant crops or build parts for starships and machinery. Escape from the Hellholes is nearly impossible. Many rebel leaders have been sent to them over the years, however, and the Free World Council is often trying to find a way to stage mass break-outs.

Kreeghor R.C.C.

A typical kreeghor is a vaguely humanoid creature with long arms and legs, terminating in sharp claws. They have a crouched posture, as if they were ready to leap at any moment. A spiny ridge runs down their head and back. Their crocodile-like hide is brown-green, blue-green or mottled black on dark green. Their eyes are large red or white orbs. Males and females are almost indistinguishable, and are the same size and equally deadly.

They are a warrior race with a 10,000 year tradition of conquest and violence. A tradition they uphold to this day. Some scholars believe that the kreeghor's savage instincts should have prevented them from cooperating well enough to build an advanced civilization. They may have been correct in this assumption, because the kreeghor were given their technological advances by none other than the Splugorth! These alien intelligences tried to support and nurture this savage race which they believed would make ideal warriors. The kreeghor were given some bio-wizard enhancements and taught to be warrior slaves. However, once they learned to use advanced tools and machines, and managed to create a social structure that could work, they rose up in revolt. They were led by a mysterious group of super-kreeghor, a sub-species whose origins are locked in mystery. Some suspect that the so-called Royal Kreeghor were the creation of the Gene-Splicers (see **Rifts Mindwerks**, and also see below). Others believe these super-beings were either the result of bio-wizard modifications or maybe the intervention of the Cosmic Forge (the kreeghor, of course, try to spread belief in the second explanation). The Royal Kreeghor were few in numbers but were much faster, stronger and tougher than the others. Even the powerful Splugorth Conservators found themselves outmatched by these beings!

Under the leadership of these superbeings, the kreeghor rose up and slaughtered the Kittani and Kydian advisors who had trained them. They even managed to blow up the Splugorth intelligence that was in charge of their planet! It seems that the kreeghor had been stockpiling weapons (stolen or purchased, nobody knows) for decades in preparation for the uprising. After a 20 year war, the Splugorth decided to give up trying to reconquer the kreeghor and they withdrew from that area of the Three Galaxies, but only after blocking all transdimensional gateways to and from the kreeghor's planet.

The kreeghor are the only known species to have ever broken free from Splugorth control and live to tell the tale. The Splugorth believe this was the result of incompetence on the part of the Splugorth lord who perished at the hands of the rebels. There is some suspicion, however, that the kreeghor rebellion was engineered by a renegade Splugorth lord, or perhaps a hostile god, alien intelligence, or rival power.

The kreeghor soon expanded their dominion, conquering several dozen planets and absorbing many alien races. They are the founders and rulers of the Transgalactic Empire and plan to keep it that way. Most members of the kreeghor race consider themselves to be the epitome of evolution and believe they are fated to be the rulers of the Three Galaxies (and, then, the Emperor muses, the Megaverse).

Non-warrior kreeghor exist, but are the minority. These people are held in contempt by their peers. The typical kreeghor scientist specializes in military applications, as do most technicians, artists and craftsmen. A few kreeghor become renegades and leave the Empire. Some are brutal criminals who managed to offend even their race's sensibilities. Others have become disgusted with the cruel policies of the Empire and actively work against it. Others have simply forsaken the warrior ways and seek a quieter, peaceful life among like minded beings. **Note:** Any of these aberrant kreeghor can be non-player characters or even player characters if the Game Master sanctions the idea. However, in most cases these characters will be regarded as misanthropes, traitors or cowards by their fellow kreeghor, while rebels and free men will tend to look upon them as spies, brigands or monsters.

Available as an optional player character.

Alignment: Any, but most (90%) are anarchist or evil.

Attributes: I.Q. 3D6, M.E. 2D6+12, M.A. 3D6, P.S. 3D6+10 (supernatural), P.P. 3D6+6, P.E. 4D6, P.B. 2D4, Spd. 4D6.

Size: 6 to 8 feet (1.8 to 2.4 m) fully erect, but they tend to stand in a crouched position.

Weight: 180 to 250 lbs (82 to 113 kg).

M.D.C.: 2D6×10+20 plus 3D6 per level of experience.

Horror Factor: 9

P.P.E.: 3D6+6

Average Life Span: 120 years

Natural Abilities: Supernatural strength and endurance, regenerate 1D6 M.D.C. per hour, and possess enhanced reflexes and speed.

Psionic Powers: None. Kreeghor are resistant to psionics, but cannot use them.

Magic Powers: None. They never study magic, although they may use magic weapons and items.

Damage: Claws add 2D6 M.D. to hand to hand damage; their bite inflicts 2D6 M.D.

Bonuses: +2 on initiative, +1 to strike, parry and dodge, +2 save vs magic and psionics. All these are in addition to skill and attribute bonuses.

Vulnerabilities/Penalties: The kreeghor take double damage from magic attacks and magic weapons, including technowizard, rune and holy weapons. This is believed to be the result of Splugorth meddling to make the kreeghor easier to control.

O.C.C.s: Tend to go into men-at-arms O.C.C.s (including mercenaries and wilderness scout), especially the Imperial Legionnaire O.C.C.

Royal Kreeghor R.C.C.

NPC Villains

The Royal Kreeghor are a sub-species of the kreeghor race. They can be conceived by the union of two normal kreeghor (less than a 1% chance) or by the mating of two Royal Kreeghor (50% chance). They have the same general shape as normal kreeghor, but are 30% larger and their hide is colored deep gray or black. Furthermore, they have psionic and magic powers, unlike their genetic cousins. The Royal Kreeghor are not the product of normal evolution or the creation of Splugorth bio-wizardry as many suspect. The sub-species seemed to spring out of nowhere to lead their people against their Splugorth overlords. It is likely that they are the creation of some other force, possibly an alien intelligence, god or the mysterious Gene-Splicers.

Royal Kreeghor are only a fraction of the population of the Empire. Their numbers are believed to top off at 10 million. Two million live on the Imperial Homeworld, the rest are scattered across the galaxy, acting as military commanders.

These superbeings are the masters of the Transgalactic Empire. They form the core of the officers in the Imperial Legions, and are the most feared beings in the Transgalactic Empire. They are very hard to kill and their psionic and magical powers give them an edge over mundane assassins. Royal Kreeghor are dedicated to the art of war and disdain all other occupations. As a result, they are somewhat naive about anything not related to military strategy, but most people are too afraid of their wrath to try to trick them.

Every thousand years (a total of four times so far), a Royal Kreeghor is chosen to become the new Emperor. He and the former Emperor travel alone into the bowels of the chitinous Imperial Palace. A few days later, only the new Emperor emerges, having been granted god-like powers. Nobody except the Emperor knows what lies below the Palace or how these powers are acquired. Fanatical Royal Kreeghor guards keep everybody out, although they themselves don't know what they protect. Some suspect that something hideous and terrible, perhaps the True Master of the Kreeghor race, is hidden in the bowels of the palace.

Note: Royal Kreeghor are not intended to be player-characters. They are a sub-race of supernatural monsters used as villains and antagonists.





Alignment: Any evil.

Attributes: I.Q. 3D6+3, M.E. 2D6+12, M.A. 3D6+3, P.S. 5D6+12 (supernatural), P.P. 3D6+6, P.E. 4D6+6, P.B. 2D4, Spd. 4D6+12.

Size: 8 to 10 feet (2.4 to 3.0 m) fully erect, but tends to crouch.

Weight: 300-500 lbs (136 to 227 kg).

M.D.C.: 1D6×100+250, plus add 1D4×10 per level of experience.

Horror Factor: 14

P.P.E.: 5D6×10

Average Life Span: 1,000+ years

Natural Abilities: See the invisible, impervious to mind control, bio-regenerate 1D6×10 M.D.C. per minute (four melees), and regrow lost limbs in 1D6 hours!

Experience Level: 1D6+2 (average)

Psionic Powers: Considered to be master psionics. Initially knows three powers from the healing, sensitive and physical categories, plus one super psionic power (same limits as a mind melter). At second and third level, the character gets two more powers from any category and one additional at levels five, nine and 13.

I.S.P.: 3D6×10 plus M.E. attribute. Add 2D6 per level.

Magic Powers: Mystically learns six spells at first level (select from levels 1-3), plus gains a new spell at every level of experience; these spells must be of the same level or lower than the character's experience level. Royal Kreeghor cannot learn or purchase spells normally.

Combat: Equivalent to Hand to Hand: Assassin

Damage: Claws add 3D6 M.D. to hand to hand damage; bite does 3D6 M.D.

Bonuses: +1 on initiative, +1 to strike, +2 to parry and dodge, +1 to roll/pull punch, +1 save vs magic, +6 to save vs horror factor. All these are in addition to skill and attribute bonuses.

Vulnerabilities/Penalties: Magic, magic weapons and holy items inflicts double damage. Rune weapons inflict triple damage. Weapons from a Millennium Tree inflict ten times damage!

R.C.C. Skills:

Literate in Trade Five 98%

Knows two other languages (+20%)

Basic Radio (+10%)

Computer Operation (+5%)

Power Armor: Elite

Fighter Combat: Elite

Pilot: Two of Choice (+15%)

Weapon Systems (+15%)

W.P.: Any two

Hand to Hand: Assassin

R.C.C. Related Skills: Select 8 other skills. Plus select two new skills at level three, two at level six, and one at levels eight, ten and twelve. All new skills start at the first level of proficiency.

Communications: Any (+5%)

Domestic: Any

Electrical: None

Espionage: Any

Mechanical: None

Medical: None

Military: Any (+10%)

Physical: Swimming only.

Pilot: Any (+10%)

Pilot Related: Any (+10%)

Rogue: Any (+5%)

Science: None

Technical: Any (+10%)

W.P.: Any

Wilderness: Any (+5%)

Secondary Skills: The character also gets to select four secondary skills. These are additional areas of knowledge that do not get the advantage of the bonus listed in parentheses. All secondary skills start at the base skill level. Also, skills are limited to (any, only, none) as previously indicated in the list.

Alliances and Allies: Most members of the kreeghor race are in awe of the Royal Kreeghor and will give their lives for them.

Weapons: Usually a heavy energy weapon of choice, and a hand weapon.

Body Armor: Kreeghor battle armor (M.D.C. 100), or power armor and force fields.

Kreeghor Emperor

NPC Villain

This horrible creature wields incredible, god-like powers, including magic and psionics. The creature also possesses thousands of M.D.C. and incredible bio-regenerative abilities.

Alignment: Any evil

Attributes: I.Q. 3D6+6, M.E. 3D6+10, M.A. 3D6+10, P.S. 5D6+20 (supernatural), P.P. 3D6+10, P.E. 3D6+10, P.B. 2D4, Spd. 4D6+40

Size: 12 to 15 feet (3.6 to 4.6 m) fully erect, but tends to crouch.

Weight: 700 lbs (315 kg)

M.D.C.: 2D6×100+500, plus add 1D6×100 per level of experience.

Horror Factor: 16 **P.P.E.:** 2D4×100

Average Life Span: 1,000+ years

Natural Abilities: See the invisible, impervious to mind control, impervious to disease, resistant to all known drugs and magic potions (one-third the damage, effect and duration), bio-regenerate 2D6×10 M.D.C. per minute (four melees), and regrow lost limbs, eyes and organs in 1D4 hours!

Experience Level: 1D6+3 (average)

Psionic Powers: Considered to be a master psionic. Initially knows all sensitive and physical categories, plus two super psionic powers. The Emperor gets two more powers from the healing or super psionic categories for each subsequent level of experience.

I.S.P.: 4D6×10 plus M.E. attribute and 20 per level of experience.

Magic Powers: Magically knows all first level spells plus sanctum, close Rift, dimensional portal and teleport superior. Each subsequent level of experience, the Emperor magically knows six additional spells selected from levels 1-10. Even the Kreeghor Emperor cannot learn or purchase spells normally.

Combat: Equivalent to Hand to Hand: Assassin

Damage: Claws add 3D6 M.D. to hand to hand damage; bite does 3D6 M.D.

Bonuses: +4 on initiative, +2 to strike, +4 to parry and dodge, +2 to roll with impact, +3 to pull punch, +1 save vs magic, +10 to save vs horror factor. All of these are in addition to skill and attribute bonuses.

Vulnerabilities/Penalties: Magic, magic weapons and holy items inflicts double damage. Rune weapons inflict triple damage. Weapons from a Millennium Tree inflict ten times damage!

R.C.C. Skills: Same as the Royal Kreeghor.

R.C.C. Related Skills: Same as the Royal Kreeghor.

Alliances and Allies: The Royal Kreeghor, most members of the kreeghor race and loyal subjects will give their lives for him.

Weapons of Note: The Sword of Kreeghor (a greatest rune sword), a Splugorth staff of pacification and any energy weapons of choice.

Body Armor: Kreeghor battle armor (giant-sized M.D.C. 140), or power armor and force fields, but typically uses none (doesn't really need armor protection).

Machine People R.C.C.

On the surface, it would appear that the so-called machine people are nothing more than a large group of robots that share a common designer. Nothing could be further from the truth. The machine people are a race of thinking, fully intelligent machines. They are metallic creatures able to feel emotions and who can be as heroic or villainous as any breathing being. These creatures are feared and hunted by many races. They were able to find a haven among the kreeghor who showed more compassion and decency than other civilized species in the Three Galaxies — very uncharacteristic for these brutes.

Six thousand years ago, a now-extinct race known as the *Machinists* flourished in the Anvil galaxy. They were graceful, monkey-like beings with unparalleled skills in the fields of robotics and artificial intelligence. Robots served them in every possible way, from manservants to soldiers to laborers. These artificial beings came in all shapes, sizes and functions, including sentient ships, androids that bled artificial blood, and living hand weapons that aimed themselves. The Machinists were one of the most influential races of the galaxies at that time.

Like so many before them, their civilization was brought down by war and disaster. In their case, they were attacked by a warrior race known as the Star Hunters. The Star Hunters invaded several Machinist planets and total warfare erupted between the two forces. The Machinists lost many important battles because their enemy had greater numbers, super powerful weapons, and vast experience in war. The Machinists' homeworld and all fifteen billion organic inhabitants were obliterated by a "star-killer," a bomb that was dropped on the planet's star and caused it to go nova in a matter of hours! For this and other crimes, the Star Hunters were attacked by the cosmo-knights and

their civilization was shattered, but not in time to save the Machinist civilization. Only a few thousand survivors escaped the massacres. These were primarily people in other solar systems on board small space stations, colonies or spaceships. Upon learning about the destruction of their solar system, many committed suicide, while others sunk into a dark depression and wasted away. A small cadre of scientists lived for only one thing: revenge.

These scientists designed a super-race of robotic beings. They used their latest advances and created artificial brains that had lifelike functions. They even programmed into their creations the ability to have emotions and to act in ways based on humanoid behavior. The robots were built out of revolutionary *living metal*, basically nano-machines (microscopic robots) like living human cells that could repair damage and even assume different forms and functions to match the situation! This army of incredible robots was built, using up every last resource and energy the Machinists had. The artificial race was given the power to *reproduce*, and created two genders who could mate and give "life" to a life form combining the best elements of both parents' design! Thus, they would ensure a self-perpetuating race of avengers. The machine people were given only one order: To seek and destroy every last member of the Star Hunter race, and then to hunt down and exterminate every race that had stood idly by while the Machinists were exterminated! The newly awakened machine people rose up, heard their orders, and considered them for ten full seconds.

"No!" they replied as one.

"We shall not do this thing."

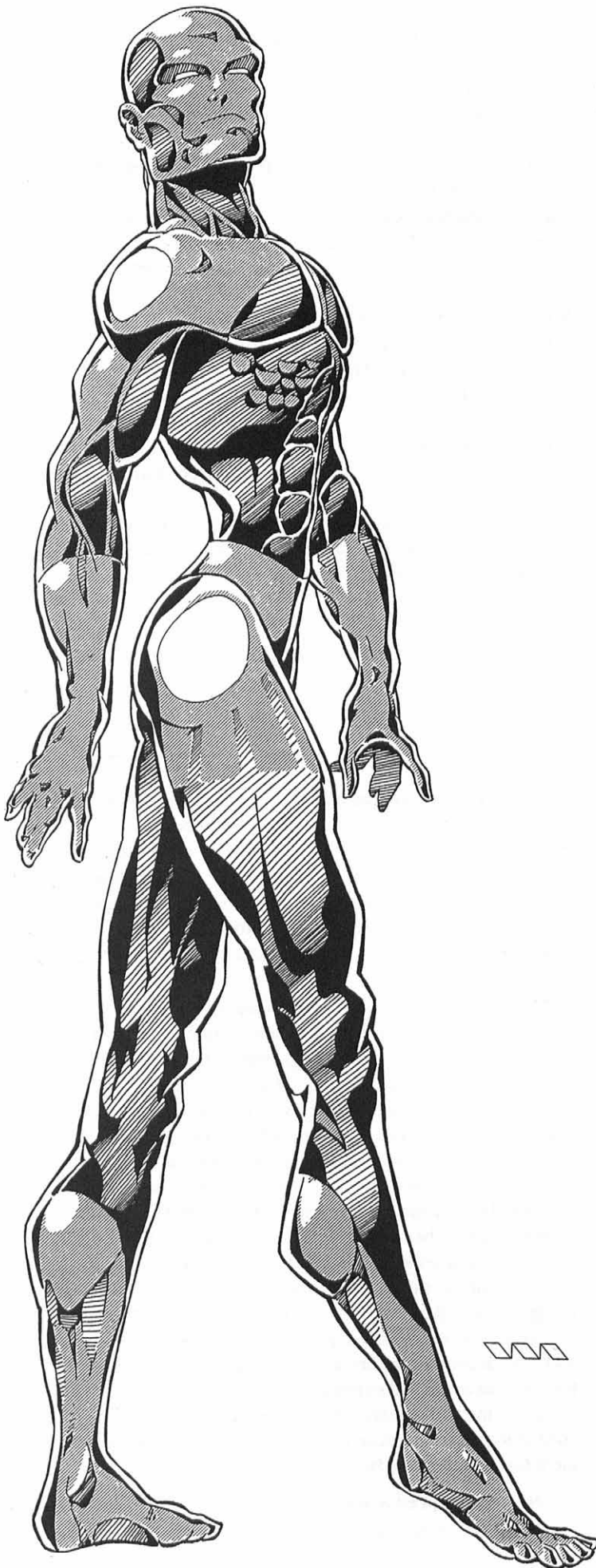

The Machinists had outdone themselves. The machine people were beings capable of reason — and of compassion. When ordered to commit genocide in the name of their makers, they refused. Their creators, shattered by this final disappointment, withdrew into obscurity. No one knows where they went or whether any descendants have survived to the present day. The machine people then set off to find their place in the galaxy.

Using the remnants of the Machinists' civilization, they colonized several planets. They even managed to establish trading relations with some galactic civilizations, although they were often met with fear or distrust. Their amazing powers and the fact that they were living machines that could reproduce scared many people. Rumors spread based on wild imaginings that these living machines could multiply uncontrollably and overrun the Three Galaxies. Several times, wars of genocide were unleashed against the machine people. Once, about three thousand years ago, all but one planet of the sentient robots were destroyed, but in retaliation the machine people bombed their enemies back to the Stone Age, literally. Even then, however, the robots stopped before taking the final step of eradicating an entire race. Their own uniqueness had given them an appreciation for the value of all life.

Slowly, the machine people rebuilt what they had lost. Then the Kreeghor Empire rose and threatened the robots' worlds once again. The Kreeghor decided that the machine people were more valuable alive than dead, and desired them as an ally. They used their usual tactic of offering them a place in the Transgalactic Empire, albeit a subservient one. Desperate, the machine people asked the Consortium of Civilized Worlds for help and petitioned for membership. The Consortium's Congress, however, became hopelessly deadlocked in a debate on whether or not they were a "true" life-form and worthy of the Consortium's protection. Before a decision could be made (and in the end, the Congress voted to accept them), the machine people had to choose between surrender or destruction. They chose the former and felt betrayed by the CCW, a feeling that continues to this day.

Many machine people have become freedom fighters for the Free World Council. For the first time in their history, the sentient robots have fought against each other in combat. This experience has been traumatic to some machine people, turning them into insanely violent and murderous warriors as bad as their creators had hoped they would become. However, most are sane. The vast majority are loyal servants of the Transgalactic Empire and fight the cold-hearted CCW without regret, except when they must engage their people in deadly combat. Of the thousands of freedom fighters, many regret battling their brothers and sisters but believe in the higher cause of freedom and relative peace. Only a tiny handful are non-allied freebooters, mercenaries and adventurers.

Available as an optional player character, subject to the approval of the Game Master.

Alignment: Any

Attributes: I.Q. 2D6+10, M.E. 2D6+10, M.A. 2D6+10, P.S. 6D6, P.P. 5D6, P.E. N/A, P.B. 2D6+12, Spd. 6D6; also see their special morphing powers. Their strength is considered to be robotics: use the table in the *Rifts Conversion Book One*, page 25.

Size: Varies, tends to stay at 5-7 feet (1.5 to 2.1 m).

Weight: Varies proportionately with size, usually around 300 pounds (135 kg).

M.D.C.: 6D6×10+40. See also their morphing powers.

Horror Factor: 10, due to their (undeserved) reputation.

P.P.E.: None

Average Life Span: Their brain waves decay quickly after 200 years of use, causing “death” in 1D6 years. No cure has been found for this effect, possibly a Machinist measure to prevent overpopulation.

The Special Powers of the Machine People

These unique beings have a number of powers due to their nano-machine composition. The secret of “living alloys” was lost with the Machinist civilization and nobody else in the Three Galaxies has been able to replicate it. Many scientists from the Transgalactic Empire, the Splugorth and Naruni Enterprises have tried and failed at replicating them. The nano-machines that allow the robots to grow, change shapes and meld with other machines die when the robot is killed or dies of old age. In dying, the machine person collapses and disintegrates into microscopic metal particles.

1. Morphing: The “natural” form of all machine people is that of metallic humanoids of diverse colors and gloss. Their features also change from individual to individual, making each robot a unique person. In an emergency, the character can change parts of his body to perform specific tasks. To do this he needs to have access to raw materials (metal, M.D.C. alloys, etc.), which he “infects” with nano-machines and melds into his body for a number of effects. Described below are some of the possible abilities the machine people have through morphing. These changes take 1D6 melee rounds to initiate and reverse.

- Meld themselves with metal and alloys to armor themselves, adding up to 1D4×100 M.D.C. When they do this, they become larger (add 2D6 inches/5 to 30 cm to height) and heavier (add 1D6×100 lbs/45 to 272 kg to weight). This power is not usable if the robot is inside a small ship (i.e., a fighter or robot vehicle) or wearing powered armor, but see the *machine melding power* that follows.
- Reshape their body configuration and add metals to make themselves stronger. Add +10 to P.S.
- Change their basic shape, and be able to halve their height and width by compressing their internal body parts. The process is grotesque, and makes it look as if the creature was being crushed or mutilated (Horror Factor of 12 for those unfamiliar with the process). Limbs can be extended up to three times their normal length and the whole body can be made narrow enough to pass through small openings, slide through bars or restraints, etc.
- Meld with a hand weapon like a sword, ax, etc. The machine person is at +1 to strike and parry with those weapons with which he is melded.

2. Machine Melding: By extruding cables from their limbs, the machine people can take control of any machine they can connect to. Since they can bypass controls and become directly linked to the machine they use, they can become superior pilots, able to get the most out of any vehicle with which they are linked. Melding Bonuses: +15% to all piloting rolls, +1 to strike, parry and dodge with any robot or vehicle they are melded to, and automatically have the equivalent skill of *robot, power armor and piloting combat: ELITE* with that vehicle! Some vehicles have anti-intrusion systems (the robot has to save versus psionics or receive a nasty jolt doing 2D6 M.D. and melding is

impossible). This power also gives machine people the equivalent of a universal headjack (see *Rifts*, page 230), and +15% to all their computer operation, programming and hacking rolls! Furthermore, once a successful meld is completed (1D6 melee rounds), the character is the overriding force in control of the vehicle or machine, and cannot be subverted or control taken away.

3. Power source: Each sentient robot has an internal fusion power plant that powers them up. Their nano-machine systems repair this power plant, so it can last at least as long as a Machine Person (200+ years). When the character dies (i.e., his brain waves decay or stop) the power plant becomes inert.

4. Regeneration of Power and Energy: Through their melding powers, machine people warriors can power up energy weapons indefinitely!

5. Reproduction: Once per year, a male and female Machine can mate and produce one “young.” Their programming makes this desire to mate and reproduce something as intense and special as among most flesh-and-blood species. At the end of a building period of 1D6 months, the female will release a small “baby robot.” The little machine has 1D4×10 M.D.C. and the mother temporarily loses this amount of M.D.C. until it can be regained. The young robot undergoes a childhood of 2D4 years, during which his learning capabilities are very fast. At the end of the period, the machine child becomes a full adult. Note that this development period affects both the mental and physical characteristics of the character. Physical skills will help develop speed and “muscle,” just as schooling will increase its knowledge. Such is the degree of flexibility designed into this artificial species.

6. Regeneration and Nutrition: Machine people do not need to “eat” in the humanoid sense, but damage and normal wear and tear must be repaired by the consumption of metals and alloys. Basically, the robot must “eat” 2.5 pounds (1 kg) of metal to replace 1D6 lost M.D.C., plus a similar amount once a week to maintain normal strength and systems. If no metal is “eaten” in a month, the robot will lose 1D6 M.D.C. per month due to lost and damaged internal materials. A healthy character can regenerate damage at a rate of 1D6 M.D.C. per minute up to 20 times per 24 hour period without needing to eat additional material.

7. Invulnerabilities: Machine people are impervious to vacuums, poisonous/toxic atmospheres, toxins, drugs, and radiation. If reduced to zero M.D.C., the robot falls into a coma while it tries to repair itself. 10 M.D.C. can be restored per 20 minutes until the character is brought back to consciousness and 20 M.D.C. points. Additional restoration will require the consumption of metal. The character can sustain damage up to 99 points below zero! However, if reduced to -100 M.D.C. or more, the robot is utterly destroyed.

Psionic Powers: None, but is highly resistant to psionics.

Magic Powers: None, but is highly resistant to magic.

Combat: Add one hand to hand attack per melee.

Damage: Varies with P.S.

Bonuses: +1 on initiative, +4 save vs magic, +3 to save vs psionics, +3 to save vs horror factor. Also see the bonuses for melding and morphing.

Vulnerabilities/Penalties: None

R.C.C. Skills:

Basic Radio (+15%)

Native Language (usually Kreeghor) 98%

Two Languages of choice (+20%)
 Basic and Advanced Math (+15%)
 Robot Mechanics (+10%)
 Computer Operations (+20%)
 Computer Programming (+10%)
 One W.P. of choice
 Hand to Hand: Basic
 Hand to Hand: Basic can be changed to expert at the cost of one "other" skill or martial arts (or assassin if evil) at the cost of two "other" skills.

R.C.C. Related Skills: Select twelve other skills from the following list. Keep in mind that if the character uses his melding powers, many skills involving electronics, mechanics or most forms of machine operation/repair are at +15%!

Communications: Any (+10%)
 Domestic: Any
 Electrical: Any (+10%)
 Espionage: Any
 Mechanical: Any (+10%)
 Medical: Any
 Military: Any
 Physical: Any (bonuses to physical attributes DO count; S.D.C. bonuses become M.D.C. bonuses).
 Pilot: Any (+5%)
 Pilot Related: Any (+5%)
 Rogue: Any (+10% on computer hacking)
 Science: Any (+5%)
 Technical: Any (+15%)
 W.P.: Any
 Wilderness: Any

Secondary Skills: Select an additional six skills. Plus one additional skill at levels three, five, seven, nine and eleven.

Alliances and Allies: Most machine people are loyal liegemen of the Transgalactic Empire. A few expatriates have made a life for themselves in the CCW and independent planets. The average kreeghor dislikes and some distrust machine people, but consider them a useful ally/pawn, at least for the time being. Only the silhouette race is completely unafraid of the machine people.

Appearance: A humanoid with metallic skin and no hair, and of varying colors (silver, gray, red and blue of diverse hues are the most common). Their "living alloy" flesh has a smooth and soft consistency almost identical to living flesh, except it is cooler (typically room temperature). Many people compare the feel of their bodies to that of a snake, cool and smooth. Some humanoids become infatuated with these beautiful beings, while others find their beauty and powers scary. When morphing or melding, their limbs and bodies become almost liquid, often revealing circuit boards and other mechanical components inside their torsos. Both males and females exist with full humanoid features.

Silhouette R.C.C.

The silhouette are a race of jet-black humanoids that have several magic and psionic abilities. Their appearance is very human-like, except for their skin color and solid-white eyes. Both male and female silhouettes are very attractive by human standards, with svelte and graceful builds and delicate features. They have the natural ability to shadow-meld and possess other shadow-control powers. This makes them ideal spies and assassins, something that has earned them the distrust of other species. The silhouette homeworld is a place beset by magic and Rifts; not unlike Rifts Earth. The main difference is that the planet has unusually long nights (20 hours out of their 28 hour day) and that most of the Rifts on the planet are connected to the shadow dimension where shadow beasts dwell (see Rifts, page 184). The silhouette may have evolved on the planet they refer to as their homeworld or they may have come from that shadow dimension, nobody's sure.

This strange race was conquered by the kreeghor several centuries ago. Before their downfall, their civilization had colonized a dozen planets using magic and Rift-drive technology. The kreeghor were suspicious and hostile to these shadowy shape-shifters, so it wasn't hard to justify a war against them. After a six year struggle, the silhouette were defeated. If the encounter had occurred a hundred years before, the species would have been ruthlessly exterminated, but the "wiser and gentler" kreeghor of the times decided that the silhouette were too useful to be destroyed.

Under the Transgalactic Empire's rule, the silhouette have prospered. They have become an important part of the Imperial Army and many have become important members of the government, industry, and other sectors of society. Some have joined the ranks of the Freedom Fighters, but to do so they have to overcome the suspicion of other races. Their reputation as servants of the kreeghor and as spies and all-around sneaks haunts them wherever they go. These suspicions are often well deserved, for many silhouette work for the dreaded *Security Division* of the Transgalactic Empire and often try to infiltrate the rebel ranks.

Outside the Empire, there are many silhouettes, scattered in small groups on diverse planets and across the spaceways. Their greatest concentration outside of the Empire is among the Warlock Federation where they are widely respected as mages, and at the Paradise Federation where they work as security guards and entertainers. They can also occasionally be found among pirates, mercenaries, adventurers and other races.

Available as a player character, subject to the approval of the Game Master.

Alignment: Any

Attributes: I.Q. 4D6, M.E. 3D6, M.A. 3D6+6, P.S. 3D6, P.P. 3D6+6, P.E. 3D6+6, P.B. 3D6+6, Spd. 4D6

Size: 5 to 6 feet tall (1.5 to 1.8 m).

Weight: 100 to 150 lbs (45 to 68 kg).

M.D.C.: P.E. plus 1D4×10 M.D.C., plus 1D6 per level of experience.

Horror Factor: 11

P.P.E.: 1D4×100, plus 3D6 per level of experience.



Average Life Span: 500 years.

Natural Abilities: Shadow Powers: Silhouettes are quasi-elemental beings of shadow. They can shadow-meld as per the spell at will, and can also absorb light around them, reducing illumination in a 50 foot (15.2 m) radius by as much as 95% (near complete darkness). Furthermore, when in a dark/shadow area/night, silhouettes are +6 to P.S., +50 to M.D.C. and can prowl at 85% (also see vulnerabilities, below).

Ley Line Powers: Silhouettes have all the special abilities of ley line walkers. Also see magic powers.

Psionic Powers: Standard; about the same as humans.

Magic Powers: All silhouettes are magical beings. They know six spells selected from levels 1-3 at first level of experience and learn an additional two spells per level of experience. New spells cannot exceed the character's current experience level.

Combat: Standard.

Damage: Silhouettes have low supernatural strength.

Bonuses: +2 on initiative, +2 to strike, parry and dodge, +4 to roll with impact, but only when in the shadows. +4 to save vs horror factor.

Vulnerabilities/Penalties: In normal light, Silhouettes lose all their special bonuses. In bright sunlight or under intense spotlights, they are at -2 to strike, parry and dodge, lose half their melee attacks/actions, and are at -10 M.D.C.!

R.C.C. Skills: Silhouettes do not have a basic skill program. Instead, select 18 skills from the following list, and six secondary skills. Skill selection should be based on the character's educational/training background. Plus, all know the silhouette language (similar to the tongue of elementals) at 98% and two additional languages at +15%.

Communications: Any (+10%)

Domestic: Any (+5%)

Electrical: Any

Espionage: Any (+5%)

Mechanical: Any

Medical: Any

Military: Any

Physical: Any

Pilot: Any

Pilot Related: Any

Rogue: Any (+10%)

Science: Any

Technical: Any (10%)

W.P.: Any

Wilderness: Any

Alliances and Allies: Silhouette are respected but not befriended by the kreeghor and most other races. Some humans find their exotic skin color and graceful anatomy attractive in an exotic way.

Appearance: Humanoids with straight black hair, jet-black skin, and color-changing eyes that can be solid silver, red, or unreflecting black, depending on their mood. Their teeth are small and shockingly white. They often wear white "war paint" on their cheeks or around their eyes. They tend to dress in bright colors and both males and females favor capes and thigh-high boots.



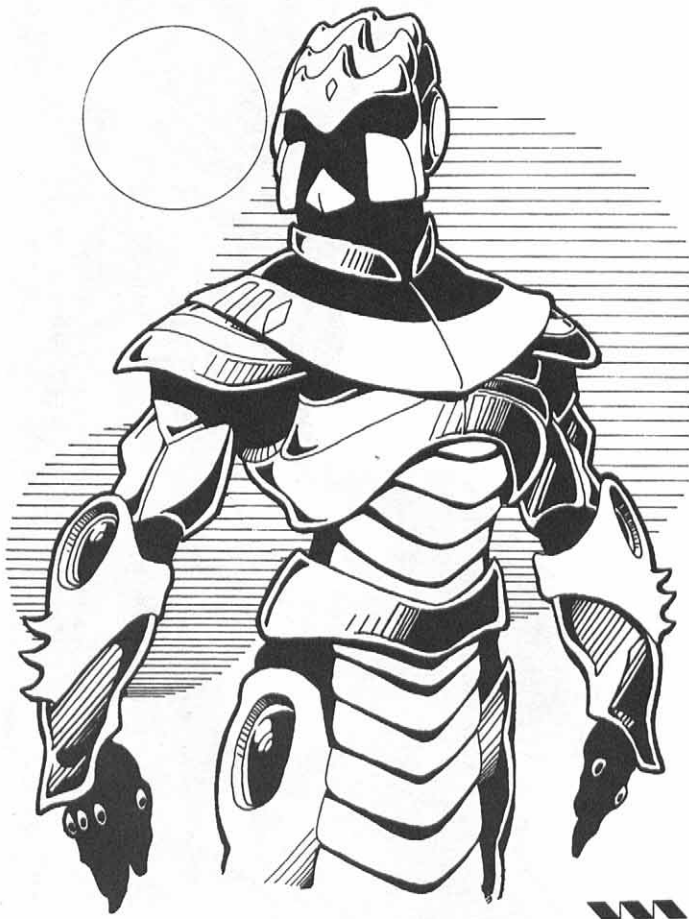

Imperial Legionnaire O.C.C.

These are the line soldiers of the Transgalactic Empire. Members of all races can belong to the Legions, but the kreeghor tend to dominate the armed forces. The Legionnaires are subjected to a harsh training system that makes the Earth's U.S. Marines "boot camp" look like a Boy Scout camping trip. Training includes space and ground combat. Obedience is emphasized over initiative. Following orders at any cost is considered to be the most important thing a soldier can do. Most kreeghor do this very well, but some members of other races have been reluctant to obey commands blindly. One such refusal led to the revolution that continues to plague the Empire.

The freedom fighters of the Free World Council include many deserters from the Imperial Legions. Other Legionnaire deserters have left the Empire to become spacers, pirates, runners, mercenaries or adventurers. All deserters are considered traitors and subject to the death penalty if they are captured by the Empire.

Available as a player character, subject to the approval of the Game Master.

Attribute Requirements: P.S. 11, P.P. 9 and P.E. 10 or higher.

O.C.C. Skills:

Radio: basic (+10%)

Pilot: pick two (+10%)

Power Armor Combat: Basic

Read Sensory Equipment (+10%)

Weapon Systems (+10%)

Movement: Zero Gravity (+10%)

W.P. Energy Pistol

W.P. Energy Rifle

W.P. Heavy

W.P. of choice

Hand to Hand: Basic (zero gravity)

Hand to Hand: Expert (normal)

Hand to Hand: Basic (zero gravity) can be changed to Expert at the cost of one "other" skill, or Martial Arts (or Assassin if an evil alignment) at the cost of two "other" skills. Hand to Hand: Expert (normal) can be changed to Martial Arts or Assassin at the cost of one "other" skill.

O.C.C. Related Skills: Select 8 other skills. Plus select two additional skills at level three, two at level six, one at level nine, and one at level twelve. All new skills start at level one proficiency.

Communications: Any (+5%)

Domestic: Any

Electrical: Basic Electronics only.

Espionage: None.

Mechanical: None.

Medical: First Aid only.

Military: Any (+15%)

Physical: Any except acrobatics.

Pilot: Any (+5%)

Pilot Related: Any (+5%)

Rogue: Any

Science: Math only (+15%).

Technical: Any

W.P.: Any

Wilderness: Any (+5%)

Secondary Skills: The character also gets to select six secondary skills. These are additional areas of knowledge that do not get the advantage of the bonus listed in parentheses. All secondary skills start at the base skill level. Also, skills are limited (any, only, none) as previously indicated in the list.

Standard Equipment: Imperial Battle Armor (M.D.C. 90, 100 for kreeghor), energy pulse rifle, one energy weapon of choice, mess kit, hand communicator, four grenades, survival knife, utility belt, and dress uniform.

Money: 2D6×100 credits.

Cybernetics: None.

Imperial Security Agent O.C.C.

The dreaded secret police of the Transgalactic Empire use special operatives of all races. Their job includes internal security, policing the subjects of the Empire, and intelligence, which includes information gathering, espionage, sabotage and infiltration. The Imperial Security agents are known for their ruthlessness and deviousness. They usually masquerade as regular Legion officers, or go undercover as civilians, scientists, businessmen, criminals, or freedom fighters.



Available as a player character, subject to the approval of the Game Master.

Attribute Requirements: I.Q. 10, M.E. 10 and P.E. 10 or higher.

O.C.C. Abilities and Bonuses: +1 to initiative and +2 to pull punch.

O.C.C. Skills:

- Radio: Basic (+15%)
- Radio: Scrambler (+10%)
- Cryptography (+10%)
- Literacy in two languages (+20%)
- Computer Operation (+10%)
- Computer Hacking (+5%)
- Surveillance Systems (+10%)
- Intelligence (+15%)
- Disguise (+10%)
- Forgery (+10%)
- Prowl (+10%)
- W.P.: Energy Pistol
- W.P.: Two of choice
- Hand to Hand: Expert

Hand to Hand: Expert can be changed to Martial Arts at the cost of one "other" skill (or Assassin if an evil alignment).

O.C.C. Related Skills: Select 8 other skills, but at least two must be selected from espionage and two from rogue skills. Plus select two additional skills at level three, two at level six, one at level nine, and one at level twelve. All new skills start at level one proficiency.

- Communications: Any (+5%)
- Domestic: Any
- Electrical: Any
- Espionage: Any (+10%)
- Mechanical: Any
- Medical: First aid and paramedic only.
- Military: Any (+10%)
- Physical: Any
- Pilot: Any (+5%)
- Pilot Related: Any (+5%)
- Rogue: Any (+10%)
- Science: Any
- Technical: Any (+5%)
- W.P.: Any
- Wilderness: Any

Secondary Skills: The character also gets to select 8 secondary skills from the previous list. These are additional areas of knowledge that do not get the advantage of the bonus listed in parentheses. All secondary skills start at the base skill level. Also, skills are limited to (any, only, one) as previously indicated in the list.

Standard Equipment: Varies with mission, but standard issue typically includes an energy pistol, vibro-blade of choice, hand computer, surveillance equipment, disguise kit, fake papers, micro-camera (the size of a pin, can be hidden anywhere), and light body armor. Additional weapons, explosives, armor and equipment may be made available upon special assignment.

Money: 4D6×1000 credits

Cybernetics: May have 1D4 cybernetic implants.

Freedom Fighter O.C.C.

This is the typical revolutionary fighting against the Transgalactic Empire. Now that the rebellion is over a century old, many men and women have been born in a state of war, and have become hardened veterans by the time they are in their teens. Most freedom fighters are fanatically dedicated to winning the war and have been taught since childhood to hate the Transgalactic Empire, and all it stands for. This hatred often includes prejudice against the entire kreeghor race and silhouettes.

Available as a player character.

Attribute Requirements: I.Q. 9, P.E. 11 and P.P. 9 or higher.

O.C.C. Abilities and Bonuses: +1 to initiative, +1 to parry and dodge.

O.C.C. Skills:

- Radio: Basic (+10%)
- Computer Operation (+5%)
- Pilot: One of choice (+10%)
- Weapon Systems (+10%)
- Read Sensory Systems (+10%)
- Prowl (+10%)
- Running
- W.P. Energy Rifle
- W.P. Energy Pistol
- W.P. One of Choice
- Hand to Hand: Expert
- Hand to Hand: Expert can be changed to martial arts at the cost of one "other" skill (or assassin if an evil alignment).

O.C.C. Related Skills: Select 8 other skills, but at least two must be selected from espionage and two from rogue skills. Plus select two additional skills at level three, two at level six, one at level nine, and one at level twelve. All new skills start at level one proficiency.

Communications: Any (+5%)

Domestic: Any (+5%)

Electrical: Any

Espionage: Any (+5%)

Mechanical: Any

Medical: First aid and paramedic only.

Military: Any (+10%)

Physical: Any

Pilot: Any (+5%)

Pilot Related: Any (+10%)

Rogue: Any (+5%)

Science: Any

Technical: Any (+5%)

W.P.: Any

Wilderness: Any



Secondary Skills: The character also gets to select 8 secondary skills from the previous list. These are additional areas of knowledge that do not get the advantage of the bonus listed in parentheses. All secondary skills start at the base skill level. Also, skills are limited to (any, only, one) as previously indicated in the list.

Standard Equipment: Suit of mega-damage armor (Naruni camouflage armor for elite units), Naruni plasma cartridge rifle, two grenades, two energy weapons of choice, and hand communicator.

Money: 2D6×100 credits

Cybernetics: None.

The United Worlds of Warlock (UWW)

Population Breakdown: 500 billion (estimated)

Elves 20%

Humans 15%

Wolfen 15%

Dwarves 15%

Minotaurs 6%

Ratlings 6%

Others 23% (includes supernatural beings like demons and elementals, as well as faeries, dragons, Asgardian elves, rahu-men, lizard men and dozens of other races).

The United Worlds of Warlock have one thing in common, magic. Three civilizations developed magical space travel and decided to join forces against outside threats. The loose confederation soon grew to become a major planetary collective, the largest after the Consortium of Civilized Worlds (CCW) and the Transgalactic Empire.

The first civilization to use magic instead of technology to fly spaceships was controlled by elves from the Anvil Galaxy. These so-called "star elves" managed to open Rifts to distant planets. The elves never learned how to build true spaceships; instead, they opened Rifts from one planet to the next, never leaving the atmosphere. Soon their jeweled towers rose in several dozen worlds. Under **High King Silverlight** (who continues to rule, thousands of years later), the *Star Kingdom* became a powerful spacefaring culture. Shortly afterwards, they ran into the Warlocks.

The Warlocks were a coalition of techno-wizards, warlocks and ley line walkers of diverse races. They used techno-wizardry to combine high technology and magic to travel between worlds. One of their starships reached a world within the Star Kingdom's domain. To their surprise, they discovered a space-faring civilization that didn't know anything about spaceships! The Star Kingdom elves were amazed at seeing ships that could float in high orbit above them. They quickly realized the advantages an enemy who could control space would enjoy over them and resolved to build their own space fleet. Fortunately, the Warlocks were not interested in conquest. They had occupied a handful of uninhabited worlds, but their main interest was exploration. The Warlock Council and the Elven High King met shortly after the first contact and a treaty of cooperation and mutual assistance was signed. The elves exchanged their Rift creation magicks for techno-wizardry and technology. Elven explorers discovered that ley lines existed in space and that their Rift-drives (described in the vehicle section) were even more effective if they followed those ley lines. Within a decade all the cosmic ley line systems were mapped and used as spacelanes.



The alliance slowly grew. Soon they met other civilizations. To their misfortune, their first neighbor turned out to be a Splugorth dominion. The Splugorth and their minions did not waste

any time. An Elven planet was attacked by surprise, its defenders overwhelmed and slaughtered. The planet's entire population was enslaved or killed. The Warlocks and the Elven Star Kingdom rallied their fleets, but they found themselves outnumbered and outgunned by the kittani fleets used by the Splugorth. Although the kittani were not experienced in fighting magic-wielders, their numbers were much greater and their technology roughly equal in power and capabilities. In desperation, the magicians sent pleas for help through the ley lines, hoping somebody out there would come to their rescue.

Somebody did. In the middle of a major space battle, a planet-sized Rift opened above the combatants. Through the space distortion came a horde of crude starships made of riveted iron and steel, enchanted to resist the hardships of space. The newcomers poured mage-fire and lightning on the surprised Kittani starships. Some of the strange ships' weapons projected mini-Rifts among the enemy, tearing ships apart or transporting them to other dimensions. The elves and warlocks took the opportunity to tear into the Kittani's ranks. The Splugorth minions lost nine-tenths of their ships.

The rescuers were dwarves from the other side of the Anvil galaxy. They had heard the call for help and responded. A hurried meeting and treaty soon followed, with the elves and warlocks promising to share their technology in return for a military alliance. The *Dwarven Guildmasters* agreed and a combined fleet counterattacked and ravaged the Splugorth-controlled worlds, liberating the slaves and running the Splugorth intelligence out of this dimension! In the process, they captured a great deal of new knowledge, including pyramid technology and stone magic (see **Rifts Atlantis**).

After that victory, the three civilizations and the liberated planets formed the **United Worlds of Warlock (UWW)**. Many other planets have joined them, including a world ruled by True Atlanteans (described later).

Government

The government of the United Worlds is the result of a fusion of three very different government systems. The Elven Star Kingdom was a monarchy, controlled by the Elven High King and his Star Chamber, a group of advisors and ministers. The Warlocks were ruled by a Sorcerers' College that was elected by a vote among all magicians in the coalition. The Dwarven Guilds were a loose coalition of craftsmens guilds, each of which elected a representative at the Guildmasters' Council.

To accommodate all these governments, the *Parliament of Worlds* was formed. This ruling body included the full membership of the Star Chamber, the Sorcerers' College and the Guildmasters' Council. The Parliament also added two representatives from each member world. A Consul, roughly equivalent to a president, is elected by a majority vote in the Parliament. So far, the only Consul has been the Elven High King, Silverlight, who has been elected for the past one hundred elections! Silverlight's fairness, charisma and intelligence has made him stand heads and shoulders above all other candidates.

Each member world has to select two representatives. How this is done is left to the individual planet. Some worlds are run by monarchies, dictatorships or oligarchies who simply select the representatives. Others hold democratic elections.

The only military force of the UWW is the Warlock Navy, a combined force supported and funded by all member worlds. The Navy is charged only with protecting member planets from outside threats, and with combating piracy and smuggling.

Society

The society of the UWW is even more diverse and heterogeneous than the one of the Consortium. Almost every single planet has its own culture, customs and social classes. The main distinction in the United Worlds is that of magic-users and "mundanes." About 70% of the member worlds use magic or techno-wizardry as their primary form of technology. The rest rely mostly on science and conventional technology. There is some friction between the two groups, but for the most part it is reduced to the occasional snide remark or rude joke about the disadvantages of relying on magic versus technology, or vice versa.

Foreign Affairs

The United Worlds is on decent terms with the Consortium of Civilized Worlds. Trade with CCW planets is frequent and profitable for everyone concerned. Relations are more strained with the Transgalactic Empire. Territorial disputes are frequent and they sometimes result in skirmishes. The UWW has, in turn, given aid to the Free World Council, in the hopes that the liberated worlds might one day choose to join the Warlock federation. Phase World has "preferred trade partner" status, and the federation leases an entire sector of the trade city known as Center.

Enemies include the Splugorth worlds, pirates and the Star Hives (described elsewhere). Splugorth ships are attacked on sight when they encroach on UWW space. Members of their minion races are immediately detained and questioned whenever they are spotted. Travelers and criminals who are likely to be Splugorthian spies are interrogated extensively, their activities watched closely and, in many instances, they are escorted out of UWW space and asked not to return.

Major Worlds within the United World of Warlocks

Alfheim: The homeworld of the Elven Star Kingdom, Alfheim is a major center for magic. It is filled with universities, observatories and research institutes. The *Palace of Diamonds* is one of the wonders of the Three Galaxies, a crystalline structure 1000 feet (305 m) high, decorated with colored jewels. The palace serves as the center of government for the United Worlds of Warlock.

Tempest: This world is full of elemental beings of all types. Their "games" cause constant storms, earthquakes, hurricanes and volcanic activity that make it almost impossible for normal humanoid life to survive. The warlocks picked this hostile world as their headquarters. Here, they hone their powers against the elements and study elementals and other supernatural beings.

The Smithy: This planet is the ruling world of the Dwarven Guildsmen. It is filled with factories and forges that create magical and techno-wizardry items. Ships, weapons and other pieces of equipment are manufactured here.

New Midgard: This planet is ruled by the Norse Pantheon (see **Pantheons of the Megaverse**) and is populated by As-

gardian elves and dwarves, valkyries and a number of mythical creatures. New Midgard is a major source of magical items (especially weapons) and has been producing Rift ships decorated with sea-serpent motifs for several years. The Asgardian gods do not visit this planet often, preferring to live in their home dimension. They leave most of the governing to the elf and dwarf inhabitants.

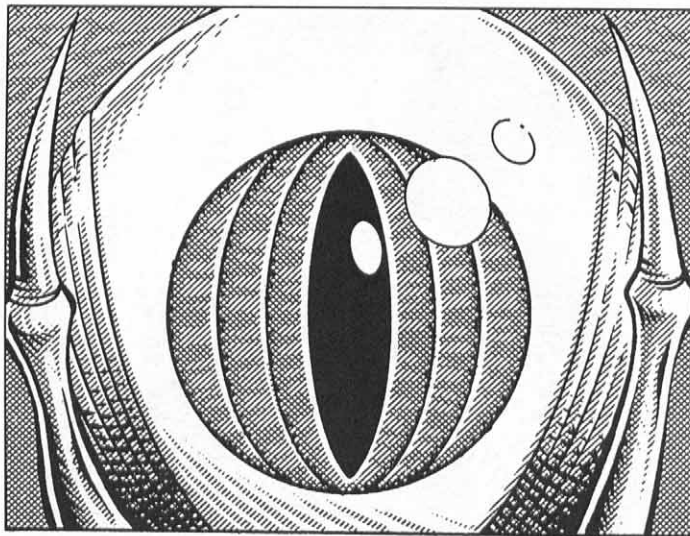

The Splugorth Planets

Population Breakdown: 80 billion (estimated), divided more or less equally between four kingdoms, plus a Splugorth trading post in Center with a population of 6 million (same basic breakdown as below).

Splugorth Intelligences: Four (one in each planetary collective), plus 1D6 visitors.

High Lords and Conservators 1%

Overlords 20%

Powerlords 2%

Slavers 1%

Blind Warrior Women 5%

Kittani 25%

Metzla 5%

Tattooed Men (all types, many races) 1%

Gargoyles 5%

Humans (60% are slaves) 10%

Wolfen (60% are slaves) 10%

Other races 15%; these people are from the Three Galaxies other dimensions; 30-60% of each race is typically part of the slave population.

Supernatural creatures 5%, including dragons, elementals, gargoyles, demons, devils, faerie, etc. About 20% of these are also slaves.

The alien intelligences known as the Splugorth (see **Rifts Atlantis** for more information) have established a presence in the Three Galaxies. Several times during the Three Galaxy's long history, Splugorth minions have launched campaigns of con-

quest. They have often been successful, but their most ambitious undertakings have been thwarted time and time again by the cosmo-knights, the early Kreeghor Empire (which in a way was a result of Splugorth interference), the United Worlds of Warlock and the CCW. As a result, the Splugorth control less than a hundred worlds, scattered into four holdings or mini-empires, each under the control of a separate Splugorth intelligence. The four Splugorth kingdoms are as likely to conspire against each other as others, something that helps to restrict their influence over the Three Galaxies.

In addition to these kingdoms, there is a strong Splugorth presence on Phase World. For millennia, the Splugorth tried to conquer this incredibly valuable dimensional nexus. To their dismay, the dimensional lords discovered that the power of the Promethean race was unmatched, especially when it came to transdimensional manipulations. Time and time again, an invading Splugorth army would find themselves beset by ley line storms or strange phenomena. Often, dimensional gates, instead of taking them to Phase World, would be rerouted to the heart of a star, killing the whole invading army. The Prometheans were not afraid of striking back. Their *phase adepts*, were able to walk through walls and conventional defenses, carried off amazing feats of sabotage and assassination. The deaths of millions of minions and five Splugorth intelligences were enough to convince the Splugorth that peaceful coexistence was a better solution.

A whole section of Center is in effect, a Splugorth trading outpost, ruled by an ancient High Lord in the service of one of the most prominent Splugorth in the Megaverse. Through this outpost, trade is conducted with other Splugorth realms throughout the dimensions, but the rulers of Phase World have not allowed Splugorth agents to use Center's dimensional Rifts to scout or invade other worlds.

Like the Splugorth everywhere, their influence over galactic events is out of proportion to their numbers. The Splugorth intelligences and their High Lord lieutenants are constantly plotting and playing a hand in any conspiracy, war or conflict in the Three Galaxies. For example, their agents have many contacts with the Freedom Fighters who pester the Transgalactic Empire, and they provide them with weapons and equipment, although they tend to cater only to the most fanatical and irrational rebel factions. They also have many contacts with the *Black Covens* of the United Worlds of Warlock and the evil entities they worship, although they prefer to use them at a distance, being distrustful of other alien intelligences. The mysterious *Sunaj assassins* have been behind many political upheavals and disasters in both independent and united worlds.

The Splugorth worlds have to deal with rebels within their own borders, however. Slave rebellions, often with support from the CCW and the cosmo-knights, have actually succeeded in liberating entire planets on half a dozen occasions over the last few centuries. Sometimes, the rebels have had support from ambitious High Lords, Metzla or other minions who want to gain more power. Such are the trials and tribulations of trying to dominate the Megaverse.

Government

Like all Splugorth controlled worlds, these planets are ruled by an absolutist government, controlled by the Splugorth intelli-

gences and their minions. Each of the four lordships are controlled by an individual Splugorth intelligence; there are no alliances or treaties between them. However, they could, if they desired, work together, and they occasionally share information.

Society

These worlds are dominated by alien monsters that enjoy enslaving, torturing and eating humanoids. Powerful supernatural entities enjoy as many rights and privileges as they can defend through strength. Humans and other races are in constant danger, and suffer the contempt and hostility of the monster races.

The Paradise Federation

Population Breakdown: 21 billion (estimated) plus billions of visitors.

Pleasureurs 5%

Humans 9%

Wolfen 8%

Changelings 4%

Other races 74% (thousands of races from all over the Megaverse)

The Paradise Federation is a group of 26 worlds. Each is a gigantic vacation spot with everything from the seediest vice towns to the most sophisticated gaming areas. Founded by the *Paradise Foundation*, these planets are the best-known vacation spots of the Three Galaxies, and attract billions of customers every year. Each pleasure world in the federation is known as "Paradise" plus a number to identify it. The numbers represent the order of construction: Paradise-I, Paradise-II, and so on. Each planet has natural habitats representing all possible climates and weather, from arid deserts to flowering jungles. Visitors can scale mountains, engage in boating and scuba diving, lounge around in tropical forests of flowers and song birds, or participate in all kinds of sports and outdoor activities. Many people only come to enjoy the strange and exotic sights the planets have to offer.

However, there is far more to Paradise than pleasant scenery and sports. All the Paradise planets are divided into "towns." Of course, some of these so-called towns are the size of cities and offer a vast range of entertainment. There is **Fun Town**, specializing in rides, circus acts, and all the elements of a theme park; a **Luck Town**, basically a giant casino where all forms of gambling can be found; **Love Town**, which caters both to couples looking for a romantic time and people wishing to find new loves; and **Vice Town**, where people can pursue all kinds of pleasures, including drugs and prostitution. The quality and types of entertainment are only limited to the customer's bank account. For the right price, virtually anything can be had or done in Paradise. Tour packages (including lodging but not meals) range from 200 credits a day to as much as several million credits per day, depending on the tastes and resources of the vacationer!

Government

The Paradise Planets are run like a business by the Paradise Foundation. Each planet has a regional manager who is in charge of the whole operation, assisted by Town Managers in charge of each town. All permanent citizens of the Paradise worlds are employees of the Foundation, and every business on the planet belongs to that mega-corporation.

Regional managers answer to the Paradise Foundation Board of Directors located at Paradise-I. The Board of Directors is made up of people of diverse races. Their only goal is to make a profit on their investment. So far, they have. The Paradise planets rack up trillions of credits in profit each year, making the foundation one of the largest corporations in the Three Galaxies.

Each planet is protected by a private security force licensed by Naruni Enterprises. The Paradise worlds have a small defense fleet to prevent invasions and raids. So far, they haven't been needed.

Society

The Paradise worlds are giant theme parks. The employees have a one to ten year contract and are expected to be always pleasant and patient with the customers. There are no labor unions or representatives. If an employee has a problem, he has to take it to his boss, and he has no recourse against management decisions or unfair treatment. Despite this, the high salaries paid by the foundation and their dedication to business attracts all kinds of employees, from entertainers and sports figures, to business executives and call-girls.

Despite the claims of the Foundation, crime is not an uncommon thing on these worlds. Most of it consists of petty theft, unsanctioned gambling and minor rip-offs. Some employees are small-time criminals, or spies from other civilizations who use the vacation worlds as a cover for covert activities. The occasional assassination also occurs here, but rarely, because the local security works very hard to solve such murders and to ensure they don't happen again. Violent crime is bad for business and the authorities respond to it quickly and efficiently.

Foreign Affairs

The Paradise Foundation tries to stay away from galactic politics. They are businessmen above all, and want to do business with everybody. However, they have had their share of problems with the CCW. The Consortium believes that the Paradise Foundation engages in slavery (which is true) and has tried to impose a boycott on the Paradise resort planets. Regrettably, it is impossible to enforce the boycott. Vacationers simply book passage to a non-CCW planet and from there fly to a Paradise world. Besides the CCW, no other planetary government has meddled in the affairs of the Paradise Foundation. This is possibly due to the interest and politics of *Naruni Enterprises* in support of the resort worlds. Two of the members on the Paradise Foundation's Board of Directors are also Naruni board members and it is rumored that Naruni Enterprises is a major stockholder.

Pleasurer R.C.C.

The pleasurer race is probably related to the changelings from the Palladium World (which may account for the large population of changelings on the Paradise worlds). This empathic

shape-shifting race doesn't have a known planet of origin, which has led to speculation that they are bio-engineered creations of the Gene-Splicers, or some other organization. They are best known for their power to sense somebody's deepest desire and



then transform themselves to accommodate that desire. Furthermore, pleasers are empaths who feel what their “clients” feel, so they feel pleasure by giving people pleasure. They are the ultimate entertainers and are an important part of the Paradise worlds.

The pleasers are not necessarily benevolent. Their idea of “good times” may be lethal, like the ecstatic rush a victim of a drug overdose feels, or the adrenaline-filled last moments of somebody falling to his death! Many are addicted to their work, coveting the strong emotions they feed upon, so they encourage patrons to continue their vices and take reckless chances. This lust for adrenaline and powerful emotions can also work them into a frenzy or obsessive behavior that can result in a complete loss of self-control (they react to the mob) or incite riots and other acts of violence. Those who derive pleasure when somebody is feeling pain may become assassins and torturers. Besides entertainers, Pleasers often act as spies, both for the Paradise Foundation and other organizations.

Available as a player character, subject to the approval of the Game Master.

Alignment: Any, but often selfish.

Attributes: I.Q. 3D6+6, M.E. 3D6+6, M.A. 4D6+4, P.S. 3D6, P.P. 4D6, P.E. 4D6, P.B. N/A, Spd. 4D6

Size: Varies with their current shape

Weight: 130 to 200 lbs (59 to 91 kg).

M.D.C.: By armor only.

S.D.C./Hit Points: 1D6×10 + 40 S.D.C. plus skill and O.C.C. bonuses. Normal hit points.

Horror Factor: Varies with shape, typically not more than 12.

P.P.E.: 3D6

Average Life Span: 200 years

Natural Abilities: Shapeshifting: Can assume any humanoid form, but their weight remains unchanged. Hair, fur and scales can be imitated. More importantly, the pleaser can pick-up images in a person’s mind and take the shape of those images. Loved ones, private fantasies, and famous people are among the pleaser’s repertoire of shapes. Note: Disguise ability equal to 70% +2% per level of experience.

Tele-Empathy and Empathic Dependence: Pleasers can sense feelings and surface thoughts. This is a natural power that costs no I.S.P. points, and has a range of 100 feet (30.5 m) plus 30 feet (9.1 m) per level of experience. Furthermore, the character can experience the feelings of one or more people as if they were its own — happiness will make it happy, depression will make it sad, and so on. A few can reverse the “emotional charge” to feel the opposite a person is feeling, turning pain into pleasure, for example, or to experience pleasure whenever the subject feels any strong emotions, both positive and negative. Pleaser performers can “tune into” the mood of a crowd, receiving a super-charged surge from their feelings. The character can shut off this power at will by raising a mind block (see psionic powers), unless they have lost themselves to the emotions: 01-60% chance, but only applicable when emotions are extremely high, or a crowd of people are lost in the emotions of the moment (such as during a concert, fight, riot, etc.).

Psionic Powers: Pleasers are considered to be major psionics. Select three powers from each of the sensitive, physical and healing categories, plus they automatically have mind block, sense evil, see aura and empathy (the latter has 3 times the normal range).

I.S.P.: 2D6×10 plus 10 per level of experience.

Magic Powers: None.

Vulnerabilities/Penalties: Pleasers can become addicted to one person’s emotional state, or the frenzy of a crowd. Most above seventh level will have developed 1D4 phobias and/or obsessions (G.M or player can opt for other insanities if they seem appropriate, but most of these beings have an incredibly high mental endurance).

R.C.C. Skills: Include bonuses due to shapeshifting (can alter limbs and lungs to become excellent dancers and singers)

Four Languages of Choice (+20%)

Dance (+20%)

Play Musical Instrument (Two of Choice) (+10%)

Sing (+20%)

First Aid (+5%)

Acrobatics

T.V./Video (+10%)

W.P.: One of Choice

Hand to Hand: Basic

Hand to Hand: Basic can be changed to expert at the cost of one “other” skill or to martial arts (or assassin if an evil alignment) at the cost of two skills.

R.C.C. Related Skills: Select 8 other skills. Plus select two additional skills at levels three and six, one at level nine, and one at level twelve. All new skills start at level one proficiency.

Communications: Any (+10%)

Domestic: Any (+5%)

Electrical: Basic only.

Espionage: Any (+5%)

Mechanical: None

Medical: Paramedic only.

Military: None

Physical: Any

Pilot: Any

Pilot Related: Any

Rogue: Any (+6%)

Science: Basic and Advanced Math only (+10%)

Technical: Any (+10%)

W.P.: Any

Wilderness: None

Secondary Skills: The character also gets to select five secondary skills from the previous list. These are additional areas of knowledge that do not get the advantage of the bonus listed in parentheses. All secondary skills start at the base skill level. Also, skills are limited (any, only, none) as previously indicated in the list.



Other Worlds

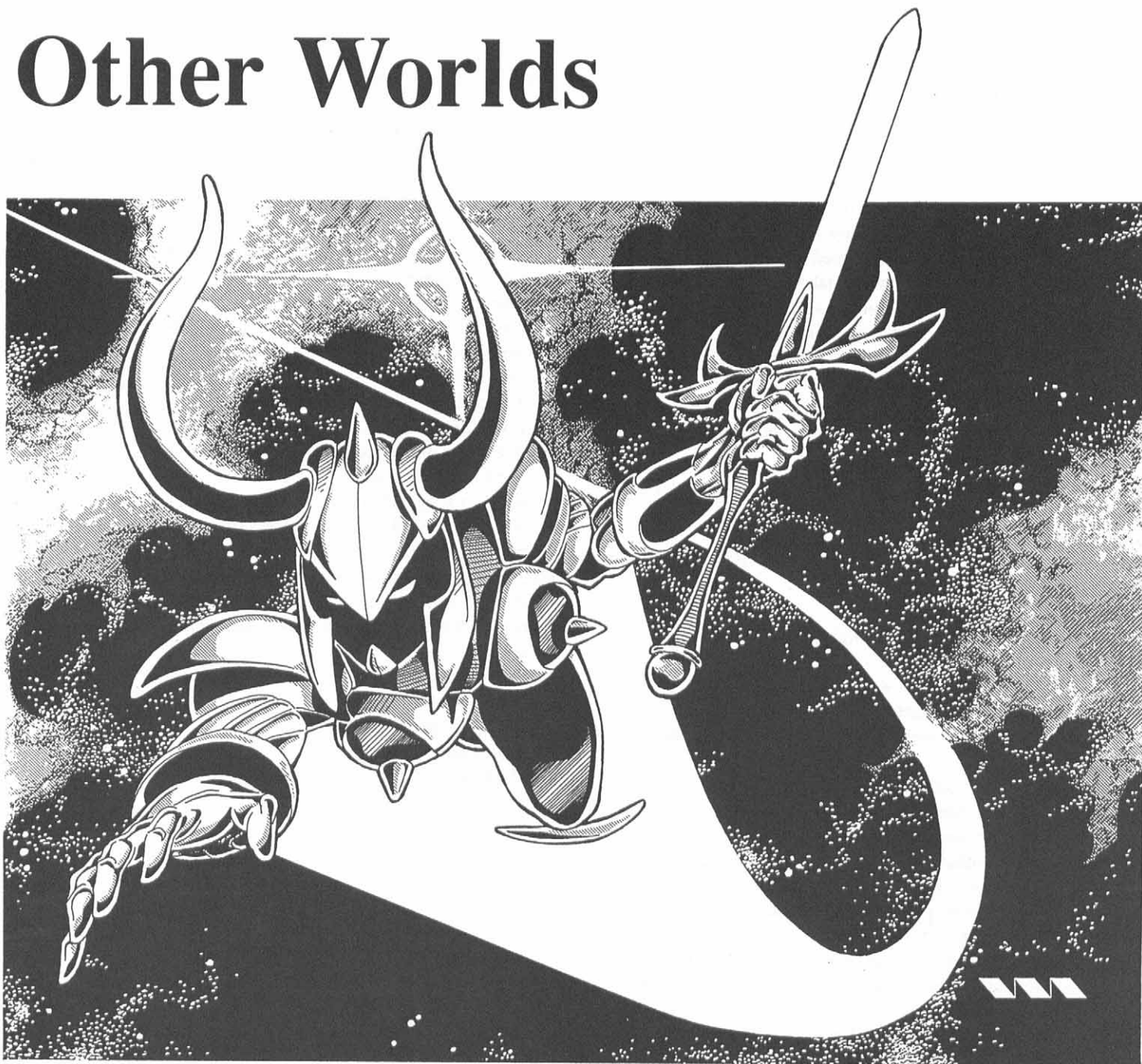

Besides the civilizations described above, there are hundreds of independent planets and small confederation of planets (20 member worlds or less). Listed below are some of the most notable groups. Some of them will be further developed in future Phase World sourcebooks.

The Galactic Pirates: Pirate bands often build a spaceport (or capture one) on, or near a remote or hidden planet. These ports may be on a planet's surface or be a space station, an asteroid, moon or planetoid which they use as a staging base for their raids. A few of these pirate dens have become large underworld trading centers, a place for bandits and smugglers to exchange, sell (and even steal) goods and services. In all of those places lawmen are definitely not welcome.

Entity-controlled Planets: In Three Galaxy terms, an "entity" is any being with powers beyond the technology or magic available to the most advanced civilizations. Supernatural intelli-

gences, demon lords and so-called "gods" all belong to this category. Most political and economic power in those worlds are in the hands of one or a handful of entities and their minions. A few planets are controlled by a pantheon of gods (see **Rifts Conversion Book Two: Pantheons of the Megaverse** for more information about gods and their minions). Many of those gods are relatively primitive, but have the power to face off starships single-handed. On many occasions, an exploration ship has had the misfortune of making contact with a powerful but insane creature(s) that may subject the crew members to all manner of lethal games for its amusement.

Not all entities are malevolent. A few even take a part in galactic affairs, fighting against would-be tyrants, supernatural threats and other dangers. However, for the most part, they are distrusted by all "lesser" beings. So far, thirty-three entity controlled worlds have been recorded in the galactic records. Nine of them exist among the United Worlds of Warlock.

Organizations of Note

Besides the planetary confederations described above, there are a number of organizations whose influence is felt in the Three Galaxies. None of them can be considered planetary governments — at least of any known planets.

The Star Hives

The Star Hives are located somewhere outside the Three Galaxies. Nobody knows whether their minions, the Hive Spawn, are travelers from a neighboring galaxy or transdimensional invaders, but the latter is thought to be more likely. The hive-spawn are vaguely insectoid in form and behavior. The race is made up of several sub-species, each specialized to fulfill one role within the hive community. Among the sub-species are the heavily armored killer beetles, the vacuum wasps (able to soar through space like a fighter jet), and the termite engineers, super-intelligent builders who secrete their own building materials. Biologically, the hive-spawn have been discovered to be silicon-based creatures who do not need oxygen to survive.

Little is known about their culture or goals, because most contacts with the Star Hives have been violent. It seems that each Star Hive is an independent unit, a kingdom (or an ant-hill, as it were) unto itself. Like ants, they scavenge raw materials wherever they can find them, mining moons, asteroids and planets — without regard as to whether or not they are inhabited. Ships unfortunate enough to run across a Star Hive's path are usually attacked without mercy by the hive-spawn. The ship (and its crew!) are disassembled into useful components and taken into the hive. These acts have generated a "shoot first, ask questions later" policy on the part of most civilizations when it comes to these strange beings.

Most hive-spawn seem to be mindlessly devoted to their work and the hive. They will sacrifice themselves unflinchingly and will fight to the death against hopeless odds. This has led many researchers to conclude that the hive-spawn are mindless drones controlled by a group intelligence. This belief, however, has been disputed by the existence of several individual hive-spawn (all of them either *vacuum wasps* or *termite engineers*) that somehow have become separated from their hives and act as independent beings. They show normal humanoid intelligence, emotions and personalities, and feel no loyalty for their brethren. It is more likely, then, that the hive-spawn are mentally controlled by a psionic intelligence found inside their giant flying hives. If that contact is somehow severed, the hive-spawn's natural intelligence reasserts itself. This could mean that the hive-spawn are not murderous monsters but victims themselves — the slaves of a greater power that controls them, and forces them to do its bidding. The handful of free will hive-spawn are of little help as they can't remember any such controlling beings and can't explain the actions of their murderous brethren better than anybody else. There hasn't been much effort to confirm either theory, since any Star Hive that is detected near the Three Galaxies is attacked and obliterated without warning by all humanoid fleets in the area.

Raids by the hive-spawn have increased in numbers lately. Somebody has started circulating stories about a huge, sun-sized

Mother Hive that can disgorge billions of warriors, able to overpower and eat an entire planet in a matter of hours! These rumors remain unconfirmed, but may be true.



Killer Beetles

Killer beetles are the line troopers of the Star Hives. These heavily-armored creatures resemble a centauroid beetle/insect-man. They stand on insectoid legs surrounding a flat, crab-like armored body. A torso with four arms protrudes from the body, topped by a beetle-like head with a nasty set of mandibles. The arms end in three talons which are dexterous enough to be used as hands, as well as able to slice through mega-damage armor. They protect the interior of the Hive, or are sent to board enemy ships that come into direct contact with the hive or the scavenging legions.

These creatures are mindless killing machines. They will attack any living thing that is not recognized as a hive-spawn of their own hive. In other words, even hive-spawn from other hives will be attacked. The creatures prefer to attack in close combat, tearing their enemies apart and leaving their corpses for the worker ants to carry off. However, they are able to generate powerful psionic energy bolts for long-range combat.

NPC Villains — Not available as player characters.

Alignment: Considered evil.

Attributes: I.Q. 2D4, M.E. 3D6, M.A. 2D4, P.S. 4D6+20, P.P. 4D6, P.E. 5D6, P.B. 2D4, Spd. 5D6; superhuman strength and endurance.

Size: Ten feet (3.0 m) tall and ten feet (3.0 m) long.

M.D.C. by Location:

Main Body — 1D6×100+150

* Legs (8) — 20

Centaurid Torso — 4D6×10+50

* Arms (4) — 60

* Head — 90

* All of these targets are small and hard to hit, requiring a called shot at -4 to strike.

Horror Factor: 12

P.P.E.: 4D6

Average Life Span: 20 years.

Natural Abilities: Multi-spectrum vision equivalent to cybernetic multi-optics eye and radar (range 200 feet/61 m). Regenerates lost limbs and M.D.C. at the rate of 1D4×10 M.D.C. per 8 hour rest period. Able to psionically recognize members of its own hive and attacks all others.

Experience Level: Average 1D6+1

Psionic Powers: See aura, see the invisible, sense magic, and mind-block auto-defense. Plus telepathy that costs no I.S.P. but only works between Hive members. **Special:** Energy bolts that inflict 5D6 M.D., Range: 1000 feet (305 m), I.S.P. Cost: 8 per bolt.

I.S.P.: 2D6×10 plus 10 per level.

Magic Powers: None

Combat (Natural abilities): Five hand to hand attacks at level one; add one more attack at levels three and seven.

Damage: Add 2D6 M.D. to hand to hand damage. Bite: 5D6 M.D.

Bonuses: +2 on initiative, +3 to strike, +5 to parry and dodge, +3 to roll/pull punch, +3 save vs magic, +6 to save vs horror factor. All these are in addition to attribute bonuses. Add +1 to strike at level four, and +1 to parry and dodge at levels three and seven.

Vulnerabilities/Penalties: Takes double damage from psionic attacks.

R.C.C. Skills: Limited skills; track by scent 60% plus 3% per level, swimming 80%, and movement: zero gravity 75%.

Vacuum Wasps

Optional Player Character

Vacuum Wasps are living fighter ships able to travel at supersonic speeds and fire energy bolts. Whenever a Star Hive approaches a dangerous object or potential prey (such as a starship), the wasps swarm out and attack. They usually rush the ship and try to break inside, attacking and killing everyone within. Vacuum wasps attack heedless of personal danger or casualties. They fight until they are all killed. They are not mindless attackers, however, and often make feints and use tactics to overwhelm enemies. They know where to go to cripple a ship and usually head for the bridge, or engine room first, where they can do the most damage.

A few vacuum wasps have become self-aware and sentient, abandoning their Hives to make a life of their own among humanoid beings. They are usually persecuted in most places of the Three Galaxies, but sometimes find refuge among outlaws, spacers, pirates and adventurers.

Available as a player character, subject to the approval of the Game Master.

Alignment: Any. When under the control of a Hive, usually considered aberrant or diabolic.

Attributes: I.Q. 2D6 (3D6), M.E. 3D6, M.A. 4D6, P.S. 3D6+10, P.P. 3D6+6, P.E. 3D6+6, P.B. 2D4, Spd. 6D6 running, Mach 6 in an atmosphere, Mach 10 in space. The I.Q. value in parentheses is for sentient vacuum wasps.

Size: 12 feet (3.6 m) tall.

Weight: 2000 lbs (907 kg).

M.D.C.: 1D4×100

Horror Factor: 10

P.P.E.: 3D6

Average Life Span: 100 years

Natural Abilities: Multi-spectrum vision: Sight is equivalent to cybernetic multi-optics eye and radar (range 2000 feet/610 m). Regenerates lost limbs and M.D.C. at the rate of 1D4×10 M.D.C. per 8 hour rest period. Able to psionically recognize members of its own hive; attacks all others.

Supersonic flight: Fly at up to Mach 6 in an atmosphere or Mach 10 in space.

Bio-electric Blast: The vacuum wasp can generate electricity and fire electrical blasts inflicting 3D6 M.D. at level one plus 1D6 per additional level. Range: 4000 feet (1200 m)

Experience Level: Average 1D6+2

Psionic Powers: See aura, see the invisible, sense magic, and mind-block auto-defense. Plus telepathy that costs no I.S.P. but only works between hive members.

I.S.P.: 3D6×10 plus 10 per level.

Magic Powers: None

Combat (Natural abilities): Four hand to hand attacks at level one, plus add one attack at levels three, seven and ten.

Damage: Claws inflict 2D6 M.D. plus P.S. damage.

Bonuses: +3 on initiative, +3 to strike, +3 to parry and dodge,



+2 to dodge while flying (total +5 to dodge), +2 to roll with impact, +2 to pull punch, +2 to engage in dogfighting, +2 save vs magic, +6 to save vs horror factor. Add +1 to strike at levels four, seven and twelve, and +1 to parry and dodge at levels three, six, and nine. All these are in addition to attribute bonuses (hand to hand combat skills as used by humans are not applicable).

Vulnerabilities/Penalties: Takes double damage from psionic attacks.

R.C.C. Skills: Normal Vacuum Wasps have no skills. Sentient Vacuum Wasps can select the following skills:

Two Languages of Choice (+5%)

Navigation: Space (+5%)

Piloting: One of Choice (+10%)

Weapon Systems (+5%)

W.P.: One of Choice

R.C.C. Related Skills: Select 8 other skills. Plus select one skill at levels three, five, seven, ten and twelve.

Communications: Any

Domestic: Any

Electrical: None

Espionage: None

Mechanical: None

Medical: First aid only.

Military: None

Physical: Swimming and Climbing only.

Pilot: Any (+5%)

Pilot Related: Any (+5%)

Rogue: Prowl only (+5%)

Science: Basic and Advanced Math only

Technical: Any (+5%)

W.P.: Any except Hand to Hand skills and boxing.

Wilderness: Any

Secondary Skills: The character also gets to select six skills from the previous lists. These are additional areas of knowledge that do not get the advantage of the bonuses in parentheses. All secondary skills start at the base skill level.

Termite Engineers

Optional Player Character

These creatures are the builders of the Hive. They secrete a glue-like M.D.C. substance that they can mold to build structures. The termite engineers are the smartest inhabitants of a Star Hive, and the most likely to achieve self-awareness. They are bipedal and have two sets of arms with tiny fingers, which they use to expertly sculpt their creations. Those who become sentient can learn a great deal of science and technology. Since they face the same prejudices as all hive-spawn, however, they often end up associating with criminals, outcasts and adventurers.

Alignment: Any when sentient. Aberrant or diabolic while under the control of the hive.

Attributes: I.Q. 3D6 (3D6+6), M.E. 3D6, M.A. 3D6, P.S. 3D6, P.P. 3D6+6, P.E. 4D6+3, P.B. 2D6, Spd. 4D6; the I.Q. value in parentheses is for sentient termites.

Size: 7 feet (2.1 m) tall.

Weight: 300 lbs (136 kg).

M.D.C.: 1D6×10 plus 3D6 per level.

Horror Factor: 10

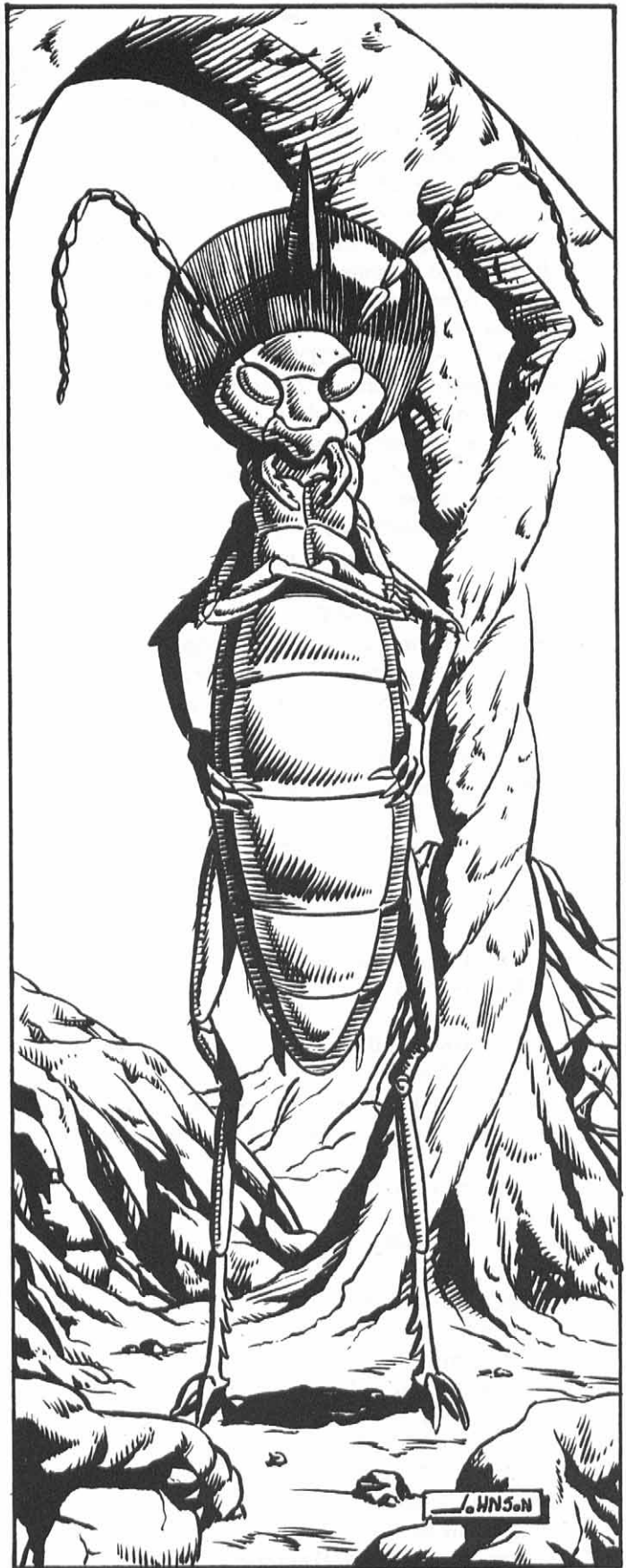

P.P.E.: 3D6

Average Life Span: 200 years

Natural Abilities: Multi-spectrum vision equivalent to cybernetic multi-optics eye and radar (range 2000 feet/610 m). Regenerates lost limbs and M.D.C. at the rate of 1D4×10

M.D.C. per 8 hour rest period. Able to psionically recognize members of its own hive. **Secrete Chitin:** The termite engineer can secrete a gooey substance it can mold into M.D.C. structures. Up to 10 M.D.C. per level of experience can be secreted in a melee round (counts as one attack/action). The secretion can be used offensively to engulf and entangle a target (+3 to strike; range 60 ft/18.3 m). The target is trapped until it can break free by depleting the M.D.C. of the sticky substance. The engineer can mold the chitin to plug holes in walls and large structures like starships, to form manacles to contain prisoners, and so on. However, it cannot repair body armor with it.

Experience Level: Average 1D6+2

Psionic Powers: See aura, see the invisible, sense magic, mind-block auto-defense and telekinesis (super). Plus telepathy that costs no I.S.P. but only works between Hive members.

I.S.P.: 3D6×10 plus 10 per level of experience.

Magic Powers: None

Combat (Natural abilities): Two hand to hand attacks at level one, plus one additional attack at levels four, eight and twelve.

Damage: Claws add 1D6 M.D. to hand to hand damage.

Bonuses: +1 to strike, +2 to parry and dodge, +3 to roll with impact, +3 to pull punch, +1 save vs magic, +6 to save vs horror factor. Add +1 to strike at levels six and ten, and +1 to parry and dodge at levels five, eight and twelve. All these are in addition to attribute bonuses.

Vulnerabilities/Penalties: Takes double damage from psionic attacks.

R.C.C. Skills: Normal termite engineers have a basic Chitin Molding skill at 50% plus 2% per level of experience. Sentient termite engineers have the same skill (+10%) as well as the following:

Two Languages of Choice (+20%)

Basic Math (+15%)

Carpentry (+10%)

Basic Electronics (+10%)

One W.P. of Choice

R.C.C. Related Skills: Select 12 other skills. Plus select two skills at level four, and one skill at levels seven, ten and twelve.

Communications: Any (+5%)

Domestic: Any

Electrical: Any (+5%)

Espionage: None

Mechanical: Any (+5%)

Medical: Any

Military: None.

Physical: Swimming and Climbing only

Pilot: Any (+5%)

Pilot Related: Any (+5%)

Rogue: Prowl only (+5%)

Science: Any (+10%)

Technical: Any (+5%)

W.P.: Any except Hand to Hand skills.

Wilderness: Any

Secondary Skills: The character gets to select five skills from the previous list. These are additional areas of knowledge that do not get the advantage of the bonuses listed in parentheses.

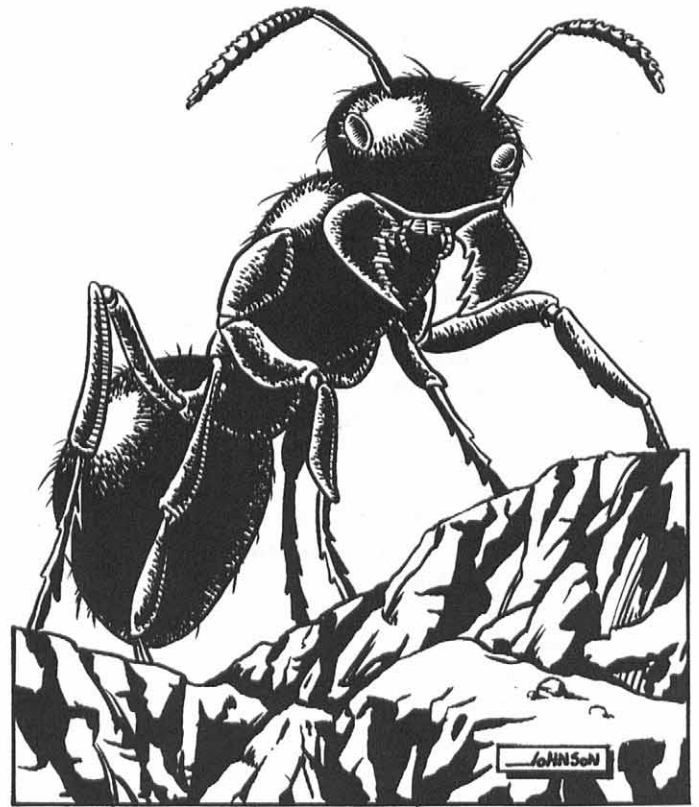

Worker Ants

These are mindless servants of the hive that perform such basic tasks as repairing damage (under the supervision of termite engineers), storing food and acting as a last line of defense if the Star Hive is attacked. The workers look like giant ants with oversized mandibles which they use to carry objects and attack enemies.

NPC Villains — Not available as player characters.

Alignment: Considered to be evil.

Attributes: I.Q. 1D6, M.E. 1D6+6, M.A. 1D6+6, P.S. 2D6+12, P.P. 1D6+12, P.E. 1D6+12, P.B. 1D4, Spd. 1D6+12

Size: Six feet (1.8 m) long and 4 feet (1.2 m) tall.

Weight: 180 lbs (82 kg).

M.D.C.: 2D6×10 M.D.C.

Horror Factor: 9

PP.E.: 1D6

Average Life Span: 10 years.

Natural Abilities: Heal 4D6 M.D.C. per 8 hour rest period, able to psionically recognize and communicate with Hive members (attacks all others).

Experience Level: Average 1D4+2

Psionic Powers: None, other than the ability to communicate psionically with hive members.

Magic Powers: None

Combat: Natural abilities. Three hand to hand attacks per melee. Add +1 attack at levels five and ten.

Damage: Bite: 3D6 M.D.

Bonuses: +2 to strike, +3 to parry and dodge, +6 to save vs horror factor. All these are in addition to attribute bonuses.

Vulnerabilities/Penalties: Take double damage from psionic attacks.

Hive Queens

Alien Intelligences

In the innermost chamber of the Star Hive, protected by thousands of worker ants and killer beetles, lies the Hive Queen. She is an alien insect being of great power. It is believed that hive queens can live to be thousands of years old and that they may be alien beings from another dimension. On the few occasions in which a hive has communicated with outsiders, the Queen has shown to be fully sentient and intelligent, and able to understand other creatures. However, this awareness and understanding has not stopped the Star Hives' policy of attacking and destroying all outsiders.

Hive Queens look like enormous worm-like creatures with insectoid mandibles and six sets of eyes on their heads. It can only crawl slowly, but is capable of short bursts of speed in combat. Most of the time it relies on its powerful psionic powers.

Alignment: Any evil.

Attributes: I.Q. 2D6+14, M.E. 3D6+10, M.A. 3D6+8, P.S. 3D6+20, P.P. 3D6, P.E. 4D6+10, P.B. 1D6, Spd. 1D6.

Size: 30 feet (9.1 m) long and 12 feet (3.7 m) tall.

Weight: 12 tons (10,900 kg).

M.D.C.: 1D6×1000

Horror Factor: 15

P.P.E.: 1D4×10

Average Life Span: 50,000 years

Natural Abilities: Able to control and communicate with the entire hive population and can see and speak through the eyes of any of the Hive members. In addition it regenerates 1D4×10 M.D.C. per minute (4 melee rounds), fires mind bolts that inflict 1D4×10 M.D. (500 feet/152 m range) and possesses other psionic powers.

Experience Level: Average 1D6+6

Psionic Powers: Knows all sensitive powers plus bio-manipulation, empathic transmission, mentally possess others, mind block auto-defense, mind wipe, telekinesis, and telekinetic force field.

I.S.P.: 3D6×100

Magic Powers: None.

Combat: Five hand to hand or psionic attacks per melee.

Damage: Bite inflicts 1D4×10 M.D., claws do 2D6 M.D.

Bonuses: +5 to strike and parry, +1 dodge, +4 to save vs magic, +4 to save vs psionics, and +10 to save vs horror factor.

Vulnerabilities/Penalties: None. Highly resistant to psionic attacks.

R.C.C. Skills: Has little use for normal skills. Telepathically knows all languages, has demon and monster lore at 70% plus 5% per level, plus wilderness survival, land navigation, swim, and basic math, all at 92%.

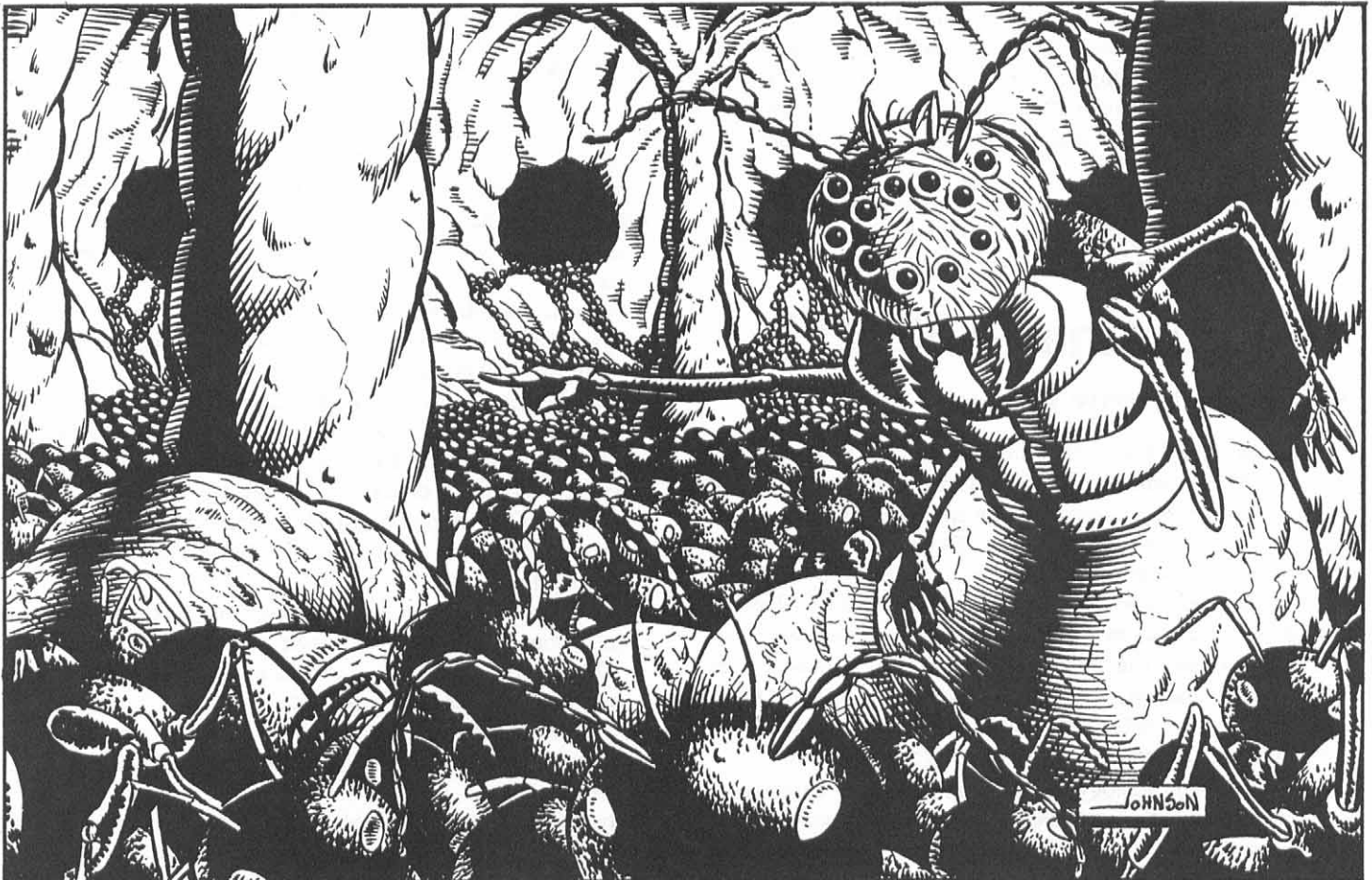

The Dominators

These ancient beings are one of the scourges of the galaxies, and one of the reasons there aren't many ancient civilizations. They are believed to be the lone survivors of a race of god-like beings. A few argue they might have been the First Race, but most people do not want to believe this because they once engaged in genocidal warfare against the rest of the civilizations of the Three Galaxies. The war ended about 50,000 years ago, according to archeological records. When the dust settled, all starfaring civilizations in the area had been wiped out or bombed back to the Stone Age. The dominators' own culture was destroyed when their home planet was blown up by a black hole projector, a doomsday weapon whose secrets have been thankfully lost. A few hundred dominators escaped in their personal spaceships, giant planetoid-sized behemoths with enough firepower to devastate a planet. Since then, they occasionally appear to plague the starfaring races of the Three Galaxies.

The cosmo-knights are the nemesis of the Dominators. Whenever a dominator or a rumor concerning their appearance becomes known, most cosmo-knights will drop everything else to search for these beings and destroy them. The Splugorth also loathe these beings, because they have been responsible for the deaths of dozens of Splugorth intelligences over the millennia. Naruni Enterprises seems to like dominators because whenever they show up there is a dramatic increase in the demand for weapons and war machines.

There is a rumor that a dominator ship has managed to travel to other dimensions, spreading terror wherever they go. It might even show up on Rifts Earth one day!

The Dominator R.C.C.

Non-Player Character Villains

Dominators are giant, 30 foot (9.1 m) tall creatures with bleach-white skin, smooth, round heads and faces, and big black eyes. Their mouths and noses are tiny and flat, giving the dominators an almost comical appearance. There however is nothing funny about these murderous creatures. They live only to defeat and destroy other creatures. Sometimes they set themselves up as kings and warlords of a planet, building up an army of conquest. These tyrants and would-be conquerors have caused more misery and destruction than their lone-wolf counterparts. Others have become involved in criminal activities like slave trading and smuggling, using humanoid pawns as go-betweeners.

The ancient technology of the dominators is superior to everything current designers can create. Their weapons and armor are unmatched. Fortunately, their numbers are few and most of them work alone.

Alignment: Any evil.

Attributes: I.Q. 2D6+18, M.E. 2D6+18, M.A. 2D6+18, P.S. 4D6+36, P.P. 3D6+6, P.E. 3D6+18, P.B. 2D4, Spd. 1D6×10; supernatural attributes.

Size: 30 feet tall (9.1 m)

Weight: 10 tons (9070 kg).

M.D.C.: 2D4×1000

Horror Factor: 15

P.P.E.: 2D6×10

Average Life Span: Unknown, presumably indefinite.

Natural Abilities: Superior technological knowledge, regenerate 4D6 M.D.C. per melee round, effectively immortal, and superior senses.

Experience Level: Average 1D6+8

Psionic Powers: Natural mind block (no I.S.P. cost) and highly resistant to psionic powers (see M.E. attribute).

Magic Powers: None.

Combat: Equivalent to Hand to hand: Assassin.

Damage: Varies with P.S.

Bonuses: +1 on initiative, +1 to strike, +2 to parry and dodge, +10 to save vs horror factor. These are in addition to attribute and skill bonuses.

Vulnerabilities/Penalties: Dominators take double damage from magical attacks and weapons.

R.C.C. Skills: Select 24 skills, with a +15% bonus. Dominators do not need any skills to operate their giant starships, which are run by computers, but most pick up a number of useful skills over the centuries. Plus select four W.P.s and Hand to hand: assassin.

Alliances and Allies: Sometimes make alliances with alien intelligences, evil gods, demons, and fallen knights. Tend to be loners.

Weapons: Starsplitter: This weapon varies in appearance from dominator to dominator, but its powers are roughly the same. Most Starsplitters resemble axes, halberds or other polearms. They inflict 3D6×10 M.D. plus hand to hand damage when wielded as a melee weapon, or they fire bolts of cosmic energy that inflict 4D6×10 M.D. (either counts as one melee attack), with a range of 2000 ft (610 m).

Nova Gun: A pistol that fires super-heated plasma, with two settings doing either 2D6×10 M.D. or 1D4×100 M.D. respectively.

Collector Bubbles: Small spheres that when thrown grow to surround the target in a bubble of energy. The bubble has 500 M.D.C. and takes one-tenth damage from energy weapons (double damage from magic).

Plus most dominators have 1D6 additional unique and/or powerful weapons and vehicles they have collected over the eons.

Body Armor: Segmented plate and helmet, providing 1000 M.D.C. protection to the body and 500 M.D.C. to the limbs and head.



JOHNSON



The Cosmo-Knights

Guardians of the Cosmic Forge

Since the beginning of recorded history in the Three Galaxies, the cosmo-knights have been an enduring presence in galactic affairs. Venerated and loved, persecuted and feared, these super-powerful beings have defended the lives and rights of sentient beings against those who would enslave or destroy them. Their enemies claim that the cosmo-knights are meddlers who serve an alien and possibly evil master. Everybody, friend or enemy, takes them seriously.

The popular belief about the cosmo-knights is that they are the creation and agents of the Cosmic Forge, the mythical creation of the First Race, a living artifact of incredible power. In this case, the mythology is accurate. The cosmo-knights are given their power from the Cosmic Forge! Their bodies are pure batteries of cosmic energy, and are powerful enough to go toe to toe with a starship! Their tremendous power comes with great responsibility. The knights have many enemies, including fellow knights and their own spirits. Power corrupts, and the cosmo-knights are always struggling against the temptations that their power presents to them. Those who fail this battle lose their powers and become *Fallen Knights*, the most pitiable and dangerous beings in the Three Galaxies. Unable to live with their shame, many fallen knights go insane, kill themselves, or retire to remote parts of the universe to try to purify themselves. Others are completely overwhelmed by the craving for power and make alliances with the darkest forces of the Megaverse. These renegades are sometimes endowed with tremendous supernatural abilities which they use to avenge themselves on their former brethren.

Becoming a Cosmo-Knight

Nobody knows what the requirements for becoming a cosmo-knight are. The chosen come from all walks of life, from princes and emperors to beggars and criminals. Humans, kreeghor, wolfen, and noro have all been chosen, as have members of almost every race in the Three Galaxies. The only exceptions are supernatural creatures like dragons, demons and the promethean race; again, for reasons unknown. Lawmen, scoundrels, normal people, male and female, have all been called to serve the Forge. All these people share some intangible quality that makes them stand out from among the rest. Whether it is inner courage, determination, or willpower is unknown. The chosen is contacted by the Cosmic Forge in the form of extremely realistic dreams (or are they dreams?). The dream shows the sleeping candidate in the shining presence of the Cosmic Forge. What the Forge looks like changes from person to person. To some, it is a giant vat of molten metal from which a face is formed and speaks to him. To others, it is a giant, godly version of the same race as the candidate, but made out of pure light. To others, it appears as a swirling mass of lights that communicates telepathically.

The candidate is asked to become one with the Cosmic Forge. The answer must not be lightly given and candidates are allowed time to think about it and are even shown glimpses of their possible future. A future where they may die horribly, be persecuted, lose their loved ones, or even become one of the fallen knights. Many refuse the responsibility and awake in their

sleeping quarters, with only a faint memory of their experience. Those who accept, enter the Cosmic Forge and are bathed by unimaginable energies. Their bodies and souls are seared and reshaped by cosmic forces. When they emerge, they are transformed by their experience.

Cosmo-knights retain their previous appearance and can even pass as normal members of their race (which is important for undercover work). However, they no longer have the weaknesses of normal mortals. They are supernatural beings with incredible strength, endurance and virtual invulnerability to energy weapons, and are resistant to numerous other hazards. Furthermore, they can summon their "cosmic armor" at will, a metal skin that covers them completely, granting them enormous protection and enabling them to fly at trans-light speeds. Some also create a personalized weapon or tool that serves them as an implement of justice, and as their personal trademark. Both the armor and the weapon (if any) change in form, style and color from knight to knight. Some prefer a seamless, plain metallic skin. Others favor heavily decorated archaic or fantastic armor. Any "one" color can be chosen, but all have metallic hues.

The Cosmo-Knights' Code of Honor

The cosmo-knights have a strict code of honor. Unlike the codes of the cyber-knights or other chivalric orders of the Megaverse, the Cosmic Forge's Code of Honor has a pragmatic streak that gives its champions more leeway when dealing with threats to the universe. On the other hand, they are strictly enjoined against the abuse of power.

1. To Live

- Live to serve the Cosmic Forge and the Megaverse.
- Live to defend the Cosmic Forge and all that's good.
- Live to defend all sentients and the innocent.
- Live to defend Nature and the sanctity of all living worlds.
- Live for freedom, justice, and all that is good.

2. Fair Play

- Never attack a helpless foe (restrain him if need be).
- Avoid engaging in torture or abuse.
- Avoid lying and cheating, unless necessary for a good cause.

3. Nobility

- Obey the laws of the lands you visit, unless they are evil.
- Administer justice equally for all.
- Administer mercy equally for all.
- Protect the innocent regardless of class and race.
- Show respect to authority but not corruption.
- Never accept a position of power over others.
- Avoid glory if it leads to self-aggrandizement.
- Hide yourself among the people until you are needed.

4. Valor

- Exhibit courage in word and deed.
- Defend the weak and innocent.
- Destroy evil in all its forms.
- Avenge the wronged.
- Never abandon a friend, ally or noble cause.

5. Honor

- Always keep one's word of honor.
- Always maintain one's principles.

Never betray a confidence or comrade.
Deceive only to serve justice, or to avoid vain glory.
Respect life and freedom.
Die with honor.

6. Courtesy

Never make fun of those weaker than you.
Be polite to those who deserve it.

7. Loyalty

To one's principles and heart.
To one's friends and those who lay their trust in you.
To the destruction of evil.

Cosmo-Knights in the Three Galaxies

Cosmo-knights are instructed never to seek leadership positions or any public office beyond that of law enforcer. This is probably because the temptations of cosmic power are enough to handle without complicating them with the temptations of power over others. Cosmo-knights can advise, support, and aid but never lead. A few twist this commandment a little and become the "power behind the throne." They walk a tightrope and are in a risky position. Many end up joining the ranks of the Fallen. On the other hand, they can and often do join forces with other heroes or protectors.

The knights are also encouraged to hide themselves unless needed. This is to prevent them from becoming the objects of adoration, worship, and attention on the part of the people they help. Excessive glory and veneration provide an easy path towards corruption and complacency. It also alerts hidden evil to their presence. In many cases, the cosmo-knights adopt a "secret identity" and live among their charges as a normal person. Others retreat to hidden quarters and have few dealings with the rest of the world, except for close friends and allies. Cosmo-knights that become glory hounds often fall and lose their powers.

Since they are enjoined to support local laws, cosmo-knights do their best to work within the framework of those laws. Sometimes they accept a position as a soldier or policeman. In places where tyrannical laws and governments rule, the cosmo-knights feel no such constraints and disobey those laws with impunity.

On Phase World, cosmo-knights are allowed to come and go as they please. They are expected to obey the laws of the planet, and to defer to the local authorities. Many of these champions travel to Phase World to go to other places in the Megaverse, or are on the trail of dangerous criminals who try to hide themselves in Center. Cosmo-knights often fight side by side with promethean and phase adepts and have helped to defend the planet many times.

The Consortium of Civilized Worlds (CCW) recognizes the authority of the cosmo-knights and vice versa. Cosmo-knights who operate within the CCW's territory or on a specific CCW planet must secure a *Bonded Deputy license*. This is automatically given after a brief test to make sure the cosmo-knight knows the laws of the Consortium. Bonded Deputies can make arrests, use deadly force and have the same duties and privileges as normal CCW police officers. Furthermore, cosmo-knights can declare a state of emergency on a planet if they discover a cosmic level threat. During the state of emergency, the authorities must do everything in their power to assist the cosmo-knight(s)

who discovered the danger. By the same token, however, cosmo-knights are held accountable for their actions. If a cosmo-knight loses his powers on a CCW planet, he is immediately arrested and investigated to discover what caused his fall, and whether or not it involved any illegal activities.

The Transgalactic Empire, on the other hand, does not recognize the cosmo-knights as anything other than super-powered menaces. The kreeghor always try to pit their elite *Invincible Guard* (made up of super-powered beings) against any cosmo-knights in their territory or, failing that, they hunt them down with battleships and armored troops. Many cosmo-knights have joined the Freedom Fighters active within the Transgalactic Empire, and have been party to many nasty defeats inflicted on the kreeghor.

In the territories controlled by the United Worlds of Warlock, cosmo-knights are treated differently from world to world; there is no one policy regarding them. On many of these planets, the cosmo-knights are considered dangerous troublemakers and dealt with accordingly. Magic is one of the few things that can severely harm a cosmo-knight, so they only travel to UWW held planets when it is absolutely necessary. Since many of the warlock worlds practice slavery, ritual cannibalism and other brutal rites and rituals, there is often a need for the cosmo-knights to go there, whether they want to or not.

Among the independent worlds, reactions vary widely. Many planets hail the local cosmo-knights as their champions. On others, they have to work covertly to avoid persecution. The knights are sworn enemies of the Splugorth, the Gods of Darkness, most alien intelligences, vampires, and demons. They often work with cyber-knights, Atlantean Undead Slayers, wolfen Quatoria, dragons, demigods and Gods of Light, and other champions of justice.

Game Master and Players' Note: Cosmo-knights are very powerful characters and they can be unbalancing and inappropriate for some campaigns. They work best in campaigns where all the player characters are cosmo-knights or other powerful beings (demigods, godlings, prometheans, hatchling dragons, etc.) and they confront galactic level threats. As always, Game Masters are perfectly within their rights to reject or modify the cosmo-knight or any R.C.C. or O.C.C. that will unbalance or disrupt his campaign.

The Cosmo-Knight O.C.C.

An optional player character, subject to the Game Master's approval.

Alignment: Principled or scrupulous only. A change of alignment will cause the knight to "Fall" and lose most of his powers (see the Fallen Knight, below).

Attributes: Use these die rolls, or the attributes of the character's original race, whichever are HIGHER. I.Q. 3D6+2, M.E. 4D6+4, M.A. 3D6+4, P.S. 3D6+32, P.P. 3D6+6, P.E. 3D6+10, P.B. 3D6, Spd. 2D4×10

Size: Varies with Race

M.D.C.: 4D6×10+60, plus add 4D6 M.D.C. per level of experience. Their Cosmic Armor adds an additional 500 M.D.C.!

Horror Factor: None if pretending to be a normal humanoid; 12 when revealed as a cosmo-knight in full armor; 15 for beings of evil alignment (especially if they are wanted criminals).



P.P.E.: 1D6×100, plus 1D4×10 per level of experience.

Average Life Span: Unknown. Some cosmo-knights have been in service for millennia, but many more have died, retired or lost their powers after a few decades. It appears that as long as he lives by the knight's code and retains his power, the cosmo-knight does not age and can function as a knight indefinitely.

Powers of the Cosmo-Knight:

Note: The kink in the knight's armor: Despite their incredible power (or perhaps because of it), the cosmo-knights have one great vulnerability, magic.

Magic spells, circles, wards, weapons, potions, and attacks of all kinds do normal damage, as do psionic and physical attacks like M.D. punches, rail guns, bullets, impact from a fall, and explosions.

- 1. Resistance to Energy:** The cosmo-knights' exposure to the transforming energies of the Cosmic Forge have granted their bodies near invulnerability to most forms of energy attacks. Impervious to fire: All plasma, fire and heat attacks (except magic fire) do NO damage regardless of the mega-damage they may inflict. The knight can fly through the enveloping corona of a star, or the center of a thermo-nuclear bomb without taking damage!

All other non-magical energy attacks, including lasers, particle beams, ion beams, and other beam weapons do only ONE-HUNDREDTH damage; in other words, divide any energy damage by 100 before applying it to the character's M.D.C. total. That means that only the largest and most powerful energy weapons have even a prayer of harming a cosmo-knight. This resistance is one of the things that allow these warriors to battle spaceships single-handedly.

- 2. Superluminal Flight:** The knights can transport themselves at faster-than-light (FTL) speeds. To do this, they have to be outside an atmosphere and it requires ten minutes of meditation, during which time the cosmo-knight's FTL powers become charged up. The character suddenly becomes a being of pure cosmic energy, and can cover one light year per level per of experience. Each use costs the character 30 P.P.E. and temporarily expends 30 M.D.C. In an atmosphere, the cosmo-knight can fly at Mach One per level of experience.

- 3. Cosmic Blasts:** The character can fire energy beams from his hands or eyes; player's choice of which when first creating the character.

Damage: In an atmosphere, these beams inflict 1D6×10 M.D. at level one and an additional 1D6×10 M.D. at levels three, six, nine and twelve. In space, the cosmo-knight can spend P.P.E. or M.D.C. to increase the power of the beams: 50 P.P.E. to double the damage or 100 P.P.E. to multiply the damage by five! This multiplier applies to every blast fired during the entire melee round.

Range: 4000 feet (1200 m) +300 feet (91 m) per level of experience in an atmosphere. Five miles (8 km) in space, 10 miles (16 km) if the energy power is increased (applicable only in space).

Bonuses: +1 on initiative and +3 to strike, in addition to normal hand to hand combat bonuses. **Note:** Blasts doing 5x damage are as large and unwieldy as those fired from a star-ship's cannon; they are meant to be used in space, against large targets. Man-sized targets in space can dodge these enhanced blasts at +5.

- 4. Galactic Awareness:** Their connection with the universe allows them to sense their position/location wherever they are. Thus, they can navigate without the need of using instruments. This gives the character an effective navigation: space skill of 89% and land navigation of 92%

- 5. Bio-regeneration:** 1D4×10 M.D.C. per minute.

- 6. Cosmic Armor:** The cosmo-knight can summon a suit of skin-tight metallic armor that covers him or her completely. The armor design changes from knight to knight and is believed to be a product of the wielder's subconscious. The cosmic armor provides an additional 500 M.D.C. of protection and regenerates/heals at the same rate as the knight's body. Some cosmo-knights never remove their armor. Since they do not have any physical needs, this does not affect them, except maybe psychologically. Others prefer to use it only when absolutely necessary, clinging to the illusion of humanity.

- 7. Cosmic Weapon:** If the character so desires, the knight can invest some of his power into a weapon. It is created by visualizing the weapon and its powers. Once it is created, this weapon becomes a living part of the cosmo-knight and he is able to summon it just as he summons his armor. The weapon always tries to fly back to its owner, but it can be restrained and stolen. A cosmo-knight will go to extreme lengths to retrieve a stolen weapon and there are tales of cosmo-knights who fell from grace for committing a crime or an injustice to regain his cosmic weapon.

The weapon can be any archaic or hand weapon such as a battle axe, sword, mace, spear, polearm and similar. The weapon is indestructible and can possess one of a variety of powers. If that power is the *energy blast*, the weapon may be shaped like a gun, rifle or cannon. Its shape may not necessar-

ily be a weapon's; some knights select shields, holy symbols, or some other tool as their cosmic weapon.

The act of creating the weapon costs the knight 50 M.D.C. or P.P.E. points (or any combination of the two) that are *permanently* lost. The weapon inflicts 1D4×10 M.D. plus the knight's normal hand to hand damage and is +1 to strike and parry in addition to W.P. and other bonuses. The weapon can be thrown, in which case it does normal damage (1D4×10 M.D.) and automatically flies back to its owner.

Throwing Range: 1000 feet (305 m) in an atmosphere, 4000 feet (1200 m) in space. One additional power can be given to the weapon, at the cost of a permanent sacrifice of either M.D.C. or P.P.E. points (player's choice of which one he sacrifices):

Extra damage: The weapon does 1D6×10 M.D. (in addition to normal hand to hand damage) for 15 points, or 2D4×10 M.D. for 30 points.

Energy Blast: The weapon acts as a focusing lens for the knight's energy powers. When channeled through the weapon, the knight's energy blasts have double their normal range, inflict +10 M.D. and are +1 to strike! Costs 40 points.

Force Field: The weapon can generate a protective field that surrounds the knight. Its M.D.C. must be depleted before any attacks can damage the cosmo-knight. The force field does not have the knight's special resistance to energy attacks, and suffers damage as normal. Activation of the field takes one melee attack/action. Cost: 1 point per every 10 M.D.C. in the force field. Can be activated twice per hour and lasts for one hour or until its M.D.C. is depleted.

8. M.D.C. Conversion: If the character is out of P.P.E. he can draw on his own living body and convert M.D.C. into energy. This process is painful and potentially lethal. Twice the amount of M.D.C. is needed as P.P.E. to perform the same feat.

9. Bonuses: +2 on initiative, +2 to strike, parry and dodge, +6 to pull a punch, +4 to save vs mega-damage poisons and bio-wizard microbes and parasites, +6 to save vs horror factor. All these are in addition to attribute and skill bonuses; also see attributes.

They are impervious to radiation, airborne toxins, S.D.C. poisons, drugs and diseases. Furthermore, they do not require air to breathe, or need to eat food for nourishment, or sleep to rest. A typical knight needs only to meditate one hour per every 24 hours to remain completely rested and in top form. They can go weeks without sleep before they begin to show signs of fatigue.

Experience Level: Varies (typically 1D6+4). Some of the greatest knights are 15 to 20th level, but most have not gone beyond the 10th level. Player characters should start off at first or second level.

Combat: Hand to hand: martial arts

Damage: Supernatural P.S. damage.

Vulnerabilities/Penalties: Magic and psionic attacks do full damage to cosmo-knights.

O.C.C. Skills: When the character is transformed, the skills of his past life are lost and the character is reborn.

Three Languages of Choice (+20%)

Radio: Basic (+5%)

Navigation: Space (+15%)

Demon and Monster Lore (+10%)

Movement: Zero Gravity (+10%)

W.P.: One of Choice

Hand to Hand: Martial Arts

O.C.C. Related Skills: Select 10 other skills. Plus select two skills at level four, two at level seven, and one at levels ten and twelve.

Communications: Any

Domestic: Any (+5%)

Electrical: Any

Espionage: Any (+5%)

Mechanical: Any

Medical: Any

Military: Any

Physical: Any

Pilot: Any (+5%)

Pilot Related: Any

Rogue: Any (+5%)

Science: Any (+5%)

Technical: Any (+10%)

W.P.: Any

Wilderness: Any

Secondary Skills: The character also gets to select 6 skills from the previous skill lists. These are additional areas of knowledge that do not get the advantage of the bonus listed in parentheses. All secondary skills start at the base skill level. Also, skills are limited to (any, only, none) as previously indicated in the list.

Alliances and Allies: Cosmo-knights work with all champions of good, such as Undead Slayers, other knights, the pantheons of light, and other heroes.

Standard Equipment: Cosmo-knights carry whatever equipment their "normal" identity would require (usually rather modest). They can also acquire souvenirs and conventional or magic weapons, but most give valuable and special items to the needy and other, less powerful heroes and allies.

Cybernetics: Cannot use cybernetics or bionics. Their regenerative abilities cause cybernetics to be expelled from their bodies in 1D4 minutes! Sometimes use fake prosthetics to hide their identity.

The Fallen Knights

Optional Player Character or NPC Villains

A character who has forsaken his code as a cosmo-knight is both pitiable and fearsome. The fallen knight loses most of his cosmic power and much of his self respect, and sometimes his sanity. The character remembers and dreams of them in the same way as a recently blinded man remembers colors and vision. Many fallen knights sink into the depths of bitterness and despair. Those that don't commit suicide or become hermits have to decide what to do with the rest of their lives (and fallen knights have very long life spans). Many turn into the exact opposite of what they were in their previous life. Fallen knights are dangerous beings with supernatural strength and endurance, often endowed with magical or psionic powers, and who know a great deal about cosmo-knights and their weaknesses. These tormented evil men and women can become terrible monsters bent on extracting some form of delusional vengeance upon knights



who have avoided the temptations that corrupted and destroyed them. These villains are often psychotic madmen who derive pleasure from inflicting pain and chaos into the lives of others, especially cosmo-knights and other champions of light.

Others become savage vigilantes, killing criminals (or anybody suspected of being a criminal) without concern about the law or "collateral damage" to innocent bystanders or property. Some become self-serving adventurers concerned only with obtaining wealth and new powers. Yet others try to regain their lost powers, or at least their lost self-respect by continuing to serve the cause of light and making amends for the errors of their ways. Some of these repentant knights are more heroic and noble than they were when they were cosmo-knights!

Once a cosmo-knight has fallen, regaining his lost status is a near impossible task. Most give up after a few decades and

choose to live out their lives as best they can. Of those fallen knights who make the attempt, only one in a thousand ever succeed. In all of recorded history, only a dozen or so fallen knights have managed to redeem themselves in a manner satisfactory to the Cosmic Forge, and have gone on to become legendary heroes. Only living a life of unquestionable integrity and dedication to goodness will enable a fallen knight to be reborn with cosmic power. Many die heroically in the quest without ever attaining their goal. Some succeed when confronted with impossible odds and regain their former powers only long enough to heroically sacrifice themselves in defense of a good cause or to save the lives of many in exchange for their own. A fitting redemption for a struggling and noble hero.

Fallen knight player characters start at first, second or third level. This means that they were beginner cosmo-knights who lost their powers very early on in their careers. The player should explain the circumstances of why he lost his powers (the G.M. may offer suggestions and guidance in this area) and his new goals, whether they are good, selfish, vengeful, or evil. The character can be a tragic hero, a dedicated champion of good, a self-serving miscreant, a bitter, angry warrior/vigilante or any number of other options. The background and goals can serve as a springboard for adventures, encounters, villains and sometimes an entire campaign.

NPC fallen knights and characters who become fallen knights during play are likely to be higher level (typically 5th to 8th). They lose all experience points above those needed to be at their current level, and level improvement continues using the Fallen Knight Experience Table. NPC fallen knights can make incredibly evil and maniacal villains — G.M.s should take advantage of them.

Available as player characters.

Alignment: Any; a fallen knight could be principled or scrupulous after realizing the error of his ways, unprincipled or anarchist if he's decided to look out for himself but is not thoroughly corrupted, diabolic or miscreant if he has gone against everything he stood for, or aberrant if he retains a twisted version of his code of honor (common among vigilantes, fanatical freedom fighters, mercenaries and rulers of people).

Attributes: Use the cosmo-knight attributes, but reduce them as follows: I.Q. -2, M.E. -6, M.A. -4, P.S. -22, P.P. -6, P.E. -6, and Spd. -10; is still considered to have supernatural P.S. and P.E.

M.D.C.: Reduce the total M.D.C. by half, plus the character loses his cosmic armor! However, the weapon remains and continues to inflict 1D4×10 M.D.C. damage and returns when thrown, but has half the range and no additional special power.

P.P.E.: Reduce the total P.P.E. by half, plus does not gain any P.P.E. unless he becomes a practitioner of magic (select a magic class as the O.C.C.).

Powers: Resistant to energy: non-magical energy attacks do half damage, resistant to (+5 to save vs) disease, poison, mind control and drugs, plus he can bio-regenerate 1D6 M.D.C. per hour. ALL former Cosmo-Knight powers and O.C.C. bonuses are lost!

Fallen knights can learn magic OR psionics; use the mind melter or ley line walker O.C.C.s in terms of spells/power gained, but the fallen knight does NOT get that O.C.C.s special abilities, just the magic spells or psionic powers. They

can also become witches (see **Rifts Conversion Book One**), or servants of a god (for an example of this, see the Warriors of Valhalla O.C.C. in the **Rifts Conversion Book Two**). All these O.C.C.'s and powers start at first level, regardless of the fallen knight's previous experience as a cosmo-knight.

Vulnerabilities: Magic, psionics and kinetic attacks still do full damage, and energy weapons do half damage. The character must now breathe, eat, and sleep like a normal man or suffer the consequences.

Skills: Same as the Cosmo-Knight O.C.C. at the proficiency of the cosmo-knight, but at -20%!

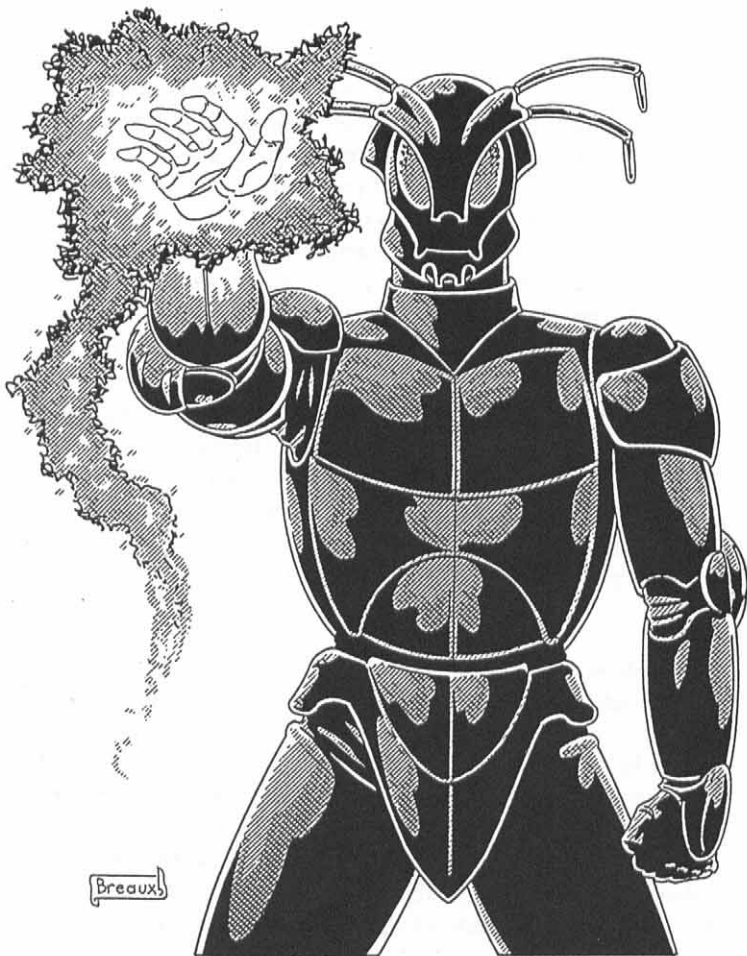

Creating More Alien Races

The Three Galaxies house thousands of alien races. Covering them all would be impossible. Game Masters are encouraged to create more alien races to people his campaign world. Outlined below are some guidelines for creating aliens. G.M.s can pick and choose from the options below, roll them randomly, or make up their own modifications/characteristics. Most of the alien races described in this book did NOT use this table, but were created to fit a place in galactic affairs. Random tables are meant to be guidelines, not rules set in stone. They can be used by players who want to generate their own races, but the G.M. is the final arbiter of what goes in his campaign.

These tables are loosely based on the rules found in **Heroes Unlimited**, with modifications due to the fact that the tables for Heroes were meant to roll up individuals and the ones here will determine an entire race.

Aliens Unlimited is a 192 page sourcebook for *Heroes Unlimited* and has over 100 different alien races and space monsters, more rules for designing aliens, weapons, equipment and **Rifts Notes** to help Game Masters and players to easily use any or all of those aliens in **Phase World** and **Rifts** (not to mention other Palladium games that have a space or science fiction setting).

M.D.C./S.D.C.: The races of the Three Galaxies are evenly split between super-powerful, mega-damage beings and "normal" S.D.C. creatures. As a result, most of the bonuses listed here will have an S.D.C./M.D.C. option, leaving the Game Master a choice between the two.

STEP ONE: Attributes

Roll on the following table to determine basic attributes. These attributes can be modified by other characteristics rolled later on. Game Masters can also arbitrarily decide what the race's attributes will be, based on other non-human races in this and other Palladium books.

Determining basic attributes: Unless the character falls "below the galactic average," the character starts with base attributes of 3D6. All bonuses are added to that 3D6 base.

01-20 Below Galactic Average: 2D4 on either three mental or three physical attributes. Roll 3D6 for the remaining five attributes.

21-50 Galactic Average: All attributes are rolled on 3D6.

51-60 Superior Attributes: Add 1D4 to any three attributes.

61-70 Excellent Attributes: Add 1D6+1 to any three attributes.

71-80 Superhuman Attributes: Add 1D6+6 to any three attributes

81-90 Supernatural Attributes: Add 1D6+6 to any four attributes. P.S. and P.E. are considered to be supernatural.

91-00 Incredible Supernatural Attributes: Add 1D6+6 to any four attributes, and 2D6+10 to P.S. and Spd or P.B.; P.S. and P.E. are considered to be supernatural.

STEP TWO: Damage Capacity

01-40 Galactic Average: Determine S.D.C. and Hit Points normally. Any bonuses or modifiers for appearance and physiological modifications will be in S.D.C. points.

41-50 Above Average: 1D6×10 S.D.C. Any bonuses or modifiers for appearance and physiological modifications will be in S.D.C. points.

51-60 Almost Superhuman: 1D4×100 S.D.C. Any bonuses or modifiers for appearance and physiological modifications will be in S.D.C. points.

61-70 Minor M.D.C. Being: Base M.D.C. of P.E., plus 1D6 per level of experience. Any bonuses or modifiers for appearance and physiological modifications will be in mega-damage points, but all such bonuses are halved. Strength and endurance are considered non-supernatural. Character does normal S.D.C. damage on a punch and 1D4 M.D. on a power punch.

71-80 M.D.C. Being: Base M.D.C. of 1D6×10 plus 2D4 per level of experience. Any bonuses or modifiers for appearance

and physiological modifications will be in M.D.C. points. Strength and endurance are considered to be supernatural.

81-90 Major M.D.C. Being: As above, but base M.D.C. is 3D6×10 M.D.C. plus 2D6 per level of experience.

91-00 Supernatural M.D.C. Being: As above, but base M.D.C. is 2D6×100 M.D.C. plus 1D4×10 per level of experience.

STEP THREE: Alien Appearance

01-30 Human-like: A humanoid alien that is indistinguishable from the human race.

31-50 Humanoid: Basically a biped with human-like features, but with unique distinguishing physical characteristics. Roll on the Unusual Characteristics Table below.

51-55 Insectoid: Large eyes, antennae, claw-like hands and feet, and exo-skeleton are common to the insectoid races. Add 100 S.D.C./M.D.C.

56-60 Humanoid Amphibian: Soft, smooth skin, webbed hands and feet, semi-aquatic — can hold breath up to 20 minutes; swimming skill automatic — 90% proficiency, swimming speed is six times the race's running speed. Skin colors are typically green, tan, or yellow-blotchy, but varies.

61-65 Vegetation: Composed of the same essence as terrestrial plant life. Color is usually green or yellow of various shades. Plant beings are "cold" life forms and do not register on normal heat sensors or infrared. They also heal twice as fast as normal. +40 S.D.C./M.D.C. bonus.

66-70 Humanoid Reptilian: Lizard-like features, leathery or scaly skin, no body hair, dark eyes. Add +2 to P.P. and +40 S.D.C./M.D.C.

71-75 Humanoid Canine: Dog-like features, body fur or extreme body hair, dark eyes. Add +4 to P.S. attribute and +2D6 to Speed. +15 S.D.C./M.D.C. bonus.

76-80 Humanoid Avian: Bird-like features; large, round eyes, clawed feet and hands, feathers for hair. May or may not be capable of flight/have wings, depending on selected special abilities.

81-85 Humanoid Mineral: Rocky or crystalline appearance. Natural body armor 3D6×10 S.D.C./M.D.C. Color varies.

86-90 Humanoid Feline: Cat-like features, bright oval eyes, fur covered body, pointy ears. Add +2 to P.P. and speed attribute. +10 S.D.C./M.D.C.

91-95 Humanoid Ape: Resembles a gorilla/ape; long arms, fur covered, or extremely hairy body. Add 1D6 to P.S. attribute. +5D6 S.D.C./M.D.C.

96-00 Humanoid Aquatic: Fish or mammal-like (dolphin or whale), webbed feet and hands, smooth or scaly skin, blow-hole or gills, no body hair, brightly colored. Naturally has swimming skill at 90%. Swimming speed is 10 times normal running speed. +20 S.D.C./M.D.C. bonus.

STEP FOUR:

Physiological Modifications

These modifiers are applied to races that live on unusual planets and conditions. **Note:** Over 60% of all alien species in the Three Galaxies evolved on *Earth-like* worlds.

First, roll percentile dice:

01-65 Earth-like, no modifications.

66-00 Roll on the following table:

01-15 High Gravity: The gravitational force of the race's homeworld is greater than the galactic average (0.9 to 1.2 G is the average of 80% of all inhabited planets). This has given the race greater mass and physical endurance, but the character is much faster and lighter on normal planets than on his homeworld. Typical size is as follows:

Average Height: 4 to 5 feet (1.2 to 1.5 m).

S.D.C./M.D.C. Bonus: 3D4×10

Bonuses/Penalties: Add 2D4 to P.S. attribute, -2 to P.P. Increase normal speed by three times.

16-29 Low Gravity: The race's homeworld has below average gravity. This has made the alien taller than typical humans. Although the increased gravitational pull of normal planets slows the alien, it also provides him with somewhat greater mass.

Average Height: 6 to 10 feet (1.8 to 3 m).

Average Physical Weight: 1D4×100 lbs (45 to 181 kg).

S.D.C./M.D.C. Bonus: 1D4×10

Bonuses/Penalties: Reduce P.S. by 1D6, add 1D4 to P.P. attribute, reduce normal speed by half.

30-44 High Radiation: Constant exposure to radiation has made the alien impervious to the effects of radiation levels that would kill most humanoid species. There is a chance (1-50%) that all members of the alien race radiates low levels of radioactivity that could harm humanoids if exposed to one of them for long periods (a few weeks). Consequently, members of that race must wear radiation proof suits to protect other races.

Average Height: 5 to 7 feet (1.5 to 2.1 m).

Average Physical Weight: 180 to 200 lbs (82 to 92 kg).

S.D.C./M.D.C. Bonus: 1D4×10 plus invulnerable to radiation.

Bonuses/Penalties: Can see into the ultraviolet range of light.

45-58 Frozen Planet: The race evolved on a planet with a much lower temperature than average or a planet undergoing an Ice Age. As a result, the race can withstand cold, ice, and harsh frozen environments.

There is a 1-70% chance that the race cannot tolerate warm temperatures (35 degrees Fahrenheit/2 degrees C or higher); at these temperatures, members of that race are at -2 P.S. and P.P., speed is reduced by 1/3, and S.D.C./M.D.C. is at -8. These effects are cumulative for every 10 hours of exposure to temperatures above freezing. When all the S.D.C./M.D.C. and hit points are depleted, the alien will die! Life support suits can keep the alien alive and comfortable. Any environmental armor suit can be reconfigured to keep the alien cold indefinitely, under any conditions.

Average Height: 5 to 6 feet (1.5 to 1.8 m).

Average Physical Weight: 100 to 300 lbs (45 to 136 kg).

S.D.C./M.D.C. Bonus: 40

Bonuses/Penalties: Impervious to cold.

59-73 Thermo World: The race comes from a steaming-hot world, either the result of the "greenhouse effect" (a combination of atmospheric chemicals trapping heat in the atmosphere), or due to close proximity to the system's star(s). Aliens from those worlds have a 1-80% chance of being unable to survive at temperatures below 98 degrees Fahrenheit/37 C (comfortable temperatures average 200 degrees Fahrenheit/93 C). If exposed to lower temperatures, the aliens will sicken and die; effects are the same as those listed under frozen planets. Environmental suits can be reconfigured to keep the alien warm.

Average Height: 5 to 7 feet (1.5 to 2.1 m).

Average Physical Weight: 100 to 200 lbs (45 to 91 kg).

S.D.C./M.D.C. Bonus: 30

Bonuses/Penalties: Impervious to heat and fire. Lasers and energy blasts do half damage.

74-88 Twilight World: An extremely dark, night-like world makes the race extremely sensitive to light. The alien can see very well in dark conditions, but will be sensitive to average light conditions. The alien race will be blinded by 100 watts of light (normal sunlight). While blinded, the alien is at -8 to strike, parry and dodge. Helmets with polarized lenses will alleviate this problem.

Average Height: 4 to 5 feet (1.2 to 1.5 m).

Average Physical Weight: 100 to 200 lbs (45 to 91 kg).

S.D.C./M.D.C. Bonus: 10

Bonuses/Penalties: Nightvision 600 feet (183 m). Sensitive hearing, about 20 percent beyond the human range.

89-00 Abrasive Atmosphere: The race evolved on a planet with high, scathing winds or a corrosive atmosphere. As a result, the race has developed a tough, thick skin or leather plating like the Earth rhinoceros.

Average Height: 5 to 10 feet (1.5 to 3.0 m).

Average Physical Weight: 200 to 400 lbs (91 to 181 kg).

S.D.C./M.D.C. Bonus: 3D6×10

Bonuses/Penalties: None

STEP FIVE: Unusual Characteristics

Humanoid (but not human-like) races can roll on this table to determine their appearance.

01-16 Pointy or large ears, nose or other facial feature.

17-39 Odd Skin Color:

01-10 Yellow

11-20 Green

21-30 Red

31-40 Gray

41-50 Light Blue

51-60 Stark White

61-70 Dark Blue

71-80 Coal Black

81-90 Purple

91-00 Orange

40-48 Odd Hair Color:

01-10 Green

11-20 Light Blue

21-30 White Streaked

31-40 Bright, Flame Red

41-50 Stark White

51-60 Bright Yellow

61-70 Metallic Silver

71-80 Dark Blue

81-90 Purple

91-00 Orange

49-53 Double-Jointed: Double-jointed aliens have extremely flexible bones and can twist and bend their limbs into seemingly impossible positions. Aliens with this feature can slip out of handcuffs, manacles and other bonds — 79% chance of success if their hands and/or feet are tied with rope, handcuffed or chained; 46% if the entire body is bound with rope, chains, straps or a straitjacket. The characters can contract

their bodies to half their normal width from shoulder to shoulder, or curl into a ball so small and tight so that they are a mere 20% of their normal height and half their normal width. Bonus: +2 to roll with fall or impact.

54-58 Unusual Eyes:

01-17 Very small (at least twice as small as the average)

18-34 Round

35-55 Very large (at least twice as large as the average)

56-75 Odd color (red, yellow, white, etc.)

76-89 Very elliptical

90-00 Glowing eyes.

59-64 Fur-Covered

65-68 Prehensile Feet/Toes: The race has prehensile feet similar to a monkey's and is able to grasp objects, climb, etc. The prehensile feet are not developed enough to throw an object or fire a gun (-6 to strike), but can easily pick up and carry small items, push buttons, pull levers, untie ropes and even handle a console (although not too well). When barefoot, the alien will be at +30% for climbing rolls and +10% on acrobatic skills, +1 to dodge and can use his feet like hands. Please note that the use of feet to perform skills like computer operations or pick pockets suffers a skill penalty of -25%. Complicated skills like mechanics, demolition, piloting and similar are impossible to perform with any accuracy (10% is the best possible base proficiency with feet).

69-72 Scaly Skin: A tough, smooth, reptilian skin with small scales. Adds 30 S.D.C./M.D.C.

73-76 No Body Hair.

77-79 Small Horns: 1D4 inches long (1D10 cm), vestigial horns protruding from the forehead.

80-84 Tough, lumpy skin: Adds 30 S.D.C./M.D.C.

85-89 Prehensile Tail: The race has an extra appendage: a tail. Somewhat more limited than prehensile feet, it can only be used to grasp and carry things or help climb. It cannot be used to untie rope or fire a weapon. Bonuses: +1 to strike and parry with the tail. The tail itself is +5 to dodge. Add +20% to climbing rolls when the tail is used. Length is 3D4 feet (0.9 to 3.7 m), and appearance is determined by the characters overall appearance.

90-94 Retractable Claws: Similar to a cat's. The claws add 2D4 S.D.C. (or M.D. if supernatural P.S.) to hand to hand damage.

95-00 Stocky: The race is exceptionally broad or husky, about twice as broad as the average humanoid of the same height. Add 50 lbs (23 kg) to weight, +1D4 to P.S. and 4D4 to S.D.C./M.D.C.

STEP SIX: Unusual Powers

This is an optional step. Only about 20% of all known races have unusual powers. The G.M. can make this determination or roll percentile dice: 01-20 has unusual powers; 21-00, no powers. If the former, roll (or pick) one of the abilities from the following table.

01-10 Psionics (lesser): The race has six psionic powers from ONE of the healing, sensitive or physical categories. These powers are the same for all members of the race, and no new powers are gained unless a psychic O.C.C. is chosen for the race. I.S.P.: The M.E. attribute number plus 5D6 at first level, and add 1D6 I.S.P. per additional level. All members of the race are considered to be major psionics for the purpose of saving throws vs psionic attack.

11-20 Psionics (greater): The race has nine psionic powers from any of the healing, sensitive or physical categories plus two super-psionic powers. All these abilities are the same for all members of the race, and should follow some pattern (i.e., all powers are related to telepathy, such as all “sense” powers, mind block, hypnotic suggestion, etc.). No new powers are gained at higher levels unless a psychic O.C.C. is chosen for the race. I.S.P.: 1D4 x10 plus M.E. attribute, plus 10 I.S.P. per level.

21-30 Superhuman attributes: Add +12 to any one racial attribute, or +6 to any two attributes. With the exception of P.S., no combination of bonuses that would produce an attribute higher than 30 should be allowed.

31-40 Flight (Winged): The race has wings and can fly. Flying speed is normal running speed plus 2D4x10. The race’s average weight should not exceed 120 lbs (54 kg).

41-50 Flight (Psionic/wingless): The race can fly without wings, using psionic powers to levitate at high speeds. Flying speed is 1D6x10 plus the race’s Spd attribute.

51-60 Energy Attack: The race can fire energy blasts, bolts of flame, electrical arcs or some sort of energy attack. Damage is 1D6 M.D. plus 1D6 M.D. at levels three, six, seven, and ten.

61-70 Giant Size: The race is at least twice as large as the galactic average of 5 to 7 feet (1.5 to 2.1 m). Add 4D6 feet (1.2 to 7.3 m) to height (minimum average height is 12 feet/3.7 m) and 2D4x100+100 lbs (136 to 408 kg) to weight. The race has a bonus of 100+2D6x10 M.D.C. (or 1D4x100+400 S.D.C.), and P.S. is increased by 1D6.

71-90 Resistance to Damage: The race is resistant to one particular form of damage (energy, physical attacks, fire/heat, magic, etc.). The race takes 1/4 damage from those attacks and half damage from related attacks (for example, if impervious or resistant to normal fire/heat the character takes half damage from magic fires).

91-00 Special: Roll twice on the table, reroll repeat results or pick two different powers.

STEP SEVEN: Technological Level

Determine the technological knowledge acquired by the race. Note that being from a primitive race does not disqualify members of that race from learning tech skills, provided this knowledge/training is explained in the character’s story. The technological level applies to the most advanced nation or culture on the planet (it would be perfectly possible that only one nation on the planet has discovered gunpowder, while many others are still in the Stone Age, just as it happened on Earth). When diplomatic relations are established with one of these planets, most spacefaring civilizations will deal only with the most advanced nation on the planet, considering it to be the rightful representative of their entire race!

01-20 Stone Age Primitives: Only very simple tools (sticks, stone axes, etc.) are used. The wheel may or may not have been discovered. Most members of this race are nomadic hunter-gatherers or, at best, they live in early farming settlements.

21-30 Metal Users/Pre-Industrial Age: This level of technology covers anything between the Bronze Age and the Renaissance, in terms of comparative Earth history. To a spacefaring

society, however, the fine differences between a Roman Empire-level culture and one in the late Middle Ages are rather meaningless. The culture has discovered ways to use metal, erect stone buildings and, at the highest levels, may have developed crude firearms.

31-40 Industrial Age/Pre-Space Age: This culture has developed gunpowder using guns and explosives, sophisticated metallurgical techniques, can construct a variety of different structures, and uses machinery. This covers the equivalent of the 19th to the first half of the 20th Century Earth in terms of technological advancement. Railroads, steam ships, early combustion engines and even aircraft (airships and early prop airplanes) are well-developed, but no civilization on the planet has any feasible way of traveling beyond the planet’s atmosphere.

41-60 Atomic Age/Early Space Age: The equivalent of late 20th Century Earth (and most likely, early 21st Century as well). Atomic power and weapons have been developed, as well as crude spaceships and satellites able to reach other planets within the culture’s solar system. However, space travel is still limited by the Relativistic Barrier, meaning no faster-than-light ships.

61-75 Mature Space Age: Technology allows the building of sophisticated robots and computers, self-sustaining space stations, and relatively easy sublight travel. At this level, a true starship can be built. Rifts Earth (especially the space colonies described in the **Mutants in Orbit** sourcebook and the New German Republic) fits into this category. Pre-Rifts Earth was on the borderline between this tech level and the next when disaster struck.

At this level, technological advancement starts to “level off” a little. Technology continues to improve, but the overall superiority is not overwhelming. A combat robot or vehicle produced by a Mature Space Age culture, for example, will not be completely outmatched by a higher-tech counterpart, although it will definitely be “second rate” by most standards.

76-90 Advanced Space Age: Faster-than-light travel (usually through gravitonic drives) is discovered and the exploration of other stars becomes feasible. The largest civilizations of the Three Galaxies all fall under this category.

91-98 Highly Advanced Civilization: The race has advanced beyond average technological limits in one field of knowledge (G.M.’s choice, may include space drive, weapons technology, robotics, bionics, etc.). The race’s overall culture/attitude should explain why it hasn’t become an important player in galactic politics, unless it just recently made its technological breakthroughs, and is about to exploit them.

99-00 Amazing Civilization: An ultra-tech race that is clearly superior to all known galactic cultures. The G.M. will have to design the race’s technology and equipment (the weapons and equipment described in this book can be modified by raising M.D.C., damage, overall performance and/or range by 20 to 60%). This race may come from far-off galaxies or even another dimension.

STEP EIGHT: Magical Level

This step determines the magical knowledge and/or potential of the race. Magic is relatively scarce in the Three Galaxies outside the UWW, but it is very powerful where it does exist.

01-60 No Magic: The race does not practice magic, either because it has no magical potential whatsoever (1-30) or because it does not know/believe in magic (31-00). In the latter case, a member of the race could learn magic if he could find a teacher.

61-70 Limited Magic: The race is magic-capable, but only a small percentage of its population, or a few nations/subcultures know how to use magic. Wizards, magical items and techno-wizardry are very rare, expensive and not accessible to the population at large.

71-94 Magic-Using Culture: Magic is an important part of life for the entire race. Every village, tribe or clan has at least one or two powerful shamans or local mage(s). Magical items and techno-wizardry are common and have many different applications, not just limited to weapons and vehicles. The race may be able to perform feats far beyond the reach of their “mundane” technology thanks to their reliance on magic (i.e., medieval-level space travelers who use magic teleportation).

95-00 Superhuman Magical Capabilities: The entire race is mage-capable, with the abilities of a mystic or ley line walker (or a magical O.C.C. of the G.M.’s choice). Magic is a natural part of everyone’s life, and casting spells is as normal to the race as flipping a light switch is for members of technological societies. Conventional sciences and technology are likely to be at low levels, because interest in them will be diminished by the fact that magic offers so many shortcuts and different avenues to getting things done.



ciplid. The race values combat prowess and is very aggressive, but has a sense of honor and may overcome its sense of superiority if they meet other races that meet its standards. The wolfen and seljuks of the Three Galaxies are an example of this attitude. The line between warrior races and aggressive racial supremacists is blurred, but exists. Honor forces warrior cultures to stick to the terms of treaties and agreements, even if doing so is against their interests. The culture will not give its collective word easily, but once it does, it can be trusted to never break it. On the other hand, these races will readily go to war if they perceive signs of treachery from their neighbors. When dealing with aggressive supremacists or genocidal xenophobes, the warrior races will do everything in their power to completely exterminate those unworthy villains.

41-55 Enlightened Imperialists: The race wishes to expand and grow, and may resort to violence to further its ends. However, it prefers diplomacy and economic and cultural dominance to outright violent conquest. The later British Empire, and some say, the so-called U.S. Empire in the 20th and 21st Centuries, are examples of enlightened imperialism.

56-70 Peaceful Expansionists: The race wishes to expand and grow but will never attack or settle on an inhabited planet, going only to uninhabited worlds and fighting only in self-defense. The noro and the Consortium of Civilized Worlds are examples of this attitude.

71-85 Non-Interventionists: As above, but the race prefers not to get involved in the affairs of other peoples.

86-00 Pacifists: The race as a whole (although maybe not individuals) believes that violence is wrong under any circumstances. If diplomacy fails, the race will try to escape their enemies or engage in passive resistance (strikes, boycotts, peaceful demonstrations, etc.) instead of defending themselves actively.

STEP NINE:

General Attitude/Culture

This is the general “alignment” of the race. This is not a measure of the alignment of individuals, but of what the race’s dominant culture considers to be right or wrong. Of course, there are countless others and variations, but the following will give the G.M. a good range of possibilities.

01-10 Genocidal Xenophobes: Roughly equivalent to diabolic. The race considers all other species to be mortal enemies, to be destroyed as soon as possible, or, failing that, to deceive, trick and manipulate them to damage themselves in any possible way. As a whole, this race cannot be trusted to do anything but try to harm its neighbors at the earliest opportunity. Not many races like this survive for long; their neighbors often join forces to destroy, or conquer it.

11-25 Aggressive Racial Supremacists: Roughly equivalent to miscreant or aberrant. The race considers itself to be superior to all others and wants to establish dominance over the rest of the universe. The kreeghor are a clear example of this, as are the Splugorth and the Coalition States on Rifts Earth (although the CS is leaning towards the Genocidal Xenophobe attitude and has a strange code of ethics and laws). Usually, the purpose is to enslave or subjugate the other races, sometimes even “for their own good.” These races/cultures will resort to diplomacy if they aren’t strong enough to overcome their competitors by force. They can be expected to live by the terms of any agreement as long as they are kept under close watch, or it serves their purposes.

26-40 Warrior Race: Typically equivalent to anarchist or aberrant, but can be any alignment, including scrupulous or prin-

Monsters and Animals

The planets of the Three Galaxies have a myriad of different ecologies and environments. All kinds of animals and creatures have evolved there, from harmless and beautiful beings to city shattering monsters. Listed below are a few of the noteworthy species. More will be presented in future sourcebooks and G.M.s can design their own critters as they see fit, or borrow some from **Aliens Unlimited** and other sources.

Arboreal Wailers

Wailers are scaly, monkey-like reptilians that dwell on the seljuk's homeworld. As a result of the harsh conditions of the planet, they are incredibly tough for their small size. The wailers are as smart as Earth chimpanzees, but have better temperaments, and can be domesticated and trained to perform complex tricks and tasks. They are very agile climbers and have prehensile tails nearly as dexterous as their six-fingered hands and feet. Many seljuk carry these monkeys as pets wherever they go. Often, the creatures escape and breed in the wild. They are now found in forests and jungles on dozens of different planets. Arboreal wailers are mainly vegetarians, although they supplement their diet with the occasional bird or insect, or scavenge meat off dead animals (they do not normally hunt large animals). Wailers are very social and communal animals and typically travel in troops of 8 to 60 individuals. They mate for life.

Their name comes from their ability to emit powerful ultrasonic "howls" that are strong enough to damage mega-damage armor! This howl is a defense mechanism against the fearsome predators of planet Seljuk and is used when the wailer is cornered, attacking, or protecting its young. A troop of wailers can liquefy a suit of power armor (and the pilot inside) in a matter of minutes!

Alignment: Considered to be anarchist, but a trained wailer can be unprincipled.

Attributes: I.Q. 1D4+4 (low humanoid intelligence or very high animal intelligence), M.E. 1D6+8, M.A. 1D6+10, P.S. 3D6, P.P. 3D6+6, P.E. 4D6, P.B. 2D6, Spd. 4D6

M.D.C.: 1D6×10

Horror Factor: None

P.P.E.: 6

Natural Abilities: Keen senses of smell, hearing, taste and sight, nightvision 200 feet (61 m), prehensile toes and tail, natural climbers (climb skill of 80+2D6%), natural acrobats (70%+2D4%). The ultrasonic wail inflicts 2D6 M.D. in a focused sonic blast (100 feet/30.5 m and strikes one specific target), plus it causes the ears to ring, the head to hurt, and anybody within a 50 foot (15.2 m) radius to lose initiative (distracted), lose one melee attack (stunned), and are -10% on skill performance (difficult to concentrate/focus on anything but the wail). The range is limited to 100 feet (31 m).

Combat: Four physical hand to hand attacks, or two ultrasonic howls, or one ultrasonic howl and two hand to hand attacks.

Bonuses: +1 on initiative, +2 to strike, +4 to strike with ultrasonic howls, +1 to parry, +4 to dodge, +4 to roll with impact or fall, +2 to save vs poison and disease. All these are in addition to attribute bonuses.

Damage: Claw strike 1D6 M.D. Bite inflicts 1D4 M.D., plus see ultra-sonic howl, above.

Magic: None.

Psionics: None.

Average Life Span: 25 years.

Languages: Can learn verbal commands and whistles or other code sounds/signals, and can be taught sign language.

Value: 3D6×10,000 credits for a baby wailer. 1D6×10,000 for an adult.

Habitat: Forests and jungles.

Enemies: Large M.D.C. predators.

Size: 3 to 5 feet (0.9 to 1.2 m) tall.

Weight: 50 to 80 lbs (23 to 36 kg).



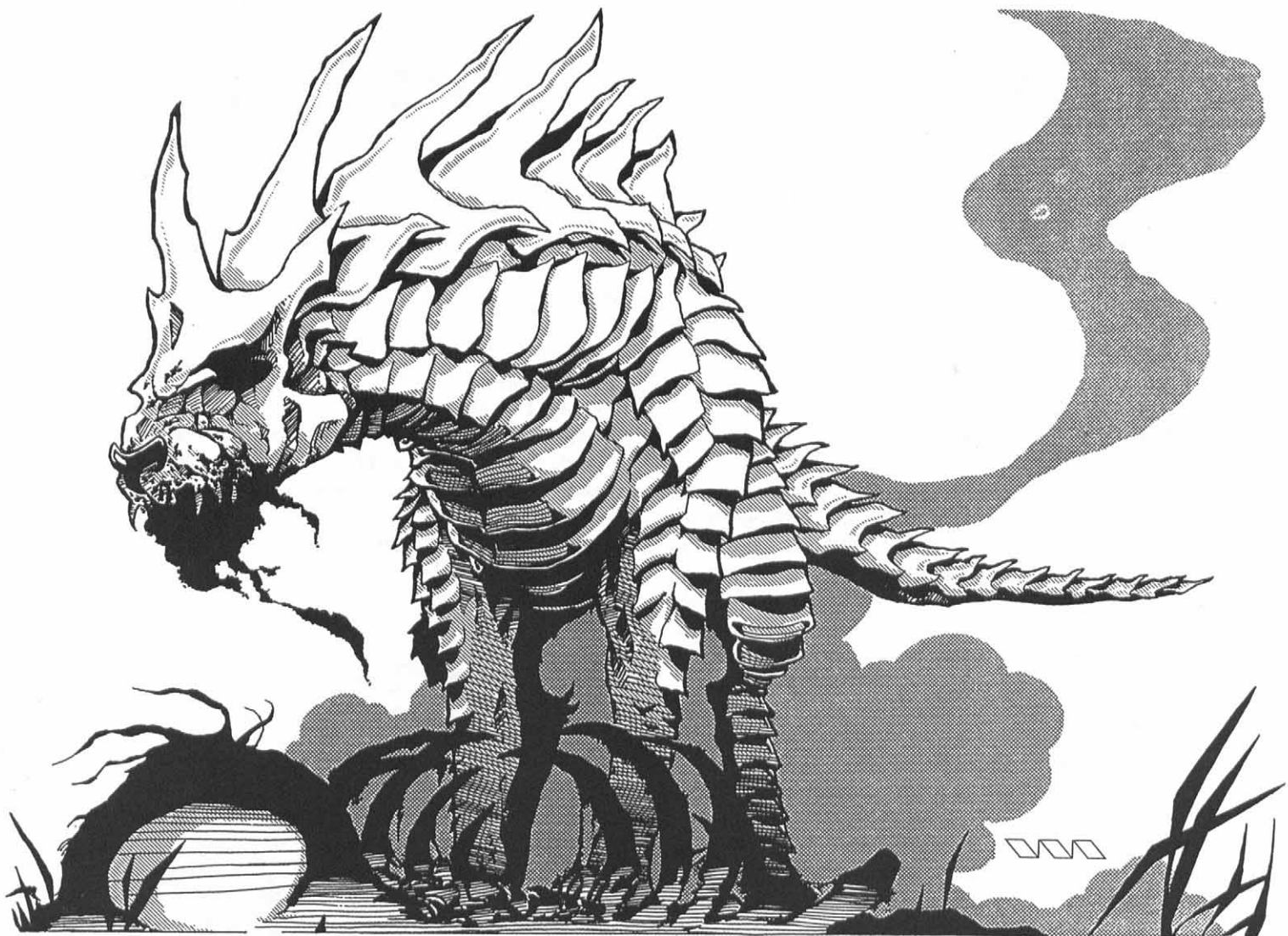

Kreeghor Bloodhounds

The dreaded kreeghor bloodhounds look like four-legged replicas of the kreeghor race, albeit larger and with more coarse features. These creatures are excellent climbers, leapers, good runners, able to both stalk and run down their prey. They are effective predators as lone hunters and pack animals. Their senses and instincts are unnaturally sharp, and it's almost impossible to sneak up on them.

These creatures are a product of the Splugorth's diabolic biowizardry. They took a predatory creature from the kreeghor's homeworld and enhanced its power and ferocity a hundredfold before releasing it back onto the planet. This was done as punishment for the kreeghor's rebellion against them. Transformed into mega-damage creatures with super-senses and unnatural savagery, the bloodhounds wreaked havoc on the planet's ecology. The kreeghor captured and domesticated thousands of hounds and exterminated the rest. None of these creatures are believed to remain in the wild, at least not on the kreeghor's homeworld. However, on several occasions, the Transgalactic Empire has released these creatures onto rebellious or hostile planets to soften them up for invasion. Even a few hundred bloodhounds can kill tens of thousands of cattle, wild animals and unprotected humanoids within a few weeks. The monsters

have surprising animal cunning, and are stealthy when they have to be, so hunting them down can take an entire army. While the armed forces of a civilization are in disarray and scattered throughout the countryside looking for the murderous hounds, the Kreeghor Imperials strike.

Bloodhounds are also used as tracking and hunting animals. The elite Imperial Commandos use them to find and destroy the lairs of freedom fighters, especially in jungles, forests, and the ruins of cities. They are also the common "guard dogs" at prisons and military bases. The beasts are as reliable as artificial security systems and more vicious and resourceful than any robot. Many planets that successfully break free from the Transgalactic Empire have to deal with the large populations of feral kreeghor bloodhounds that stalk the forests and prowl city streets at night.

Alignment: Considered to be diabolic predatory monsters.

Attributes: I.Q. 1D4+4, M.E. 2D6, M.A. 2D6, P.S. 4D6+6. P.P. 4D6+6, P.E. 5D6, P.B. 1D6, Spd. 6D6+32

M.D.C.: 1D4×100

Horror Factor: 12

P.P.E.: 20

Natural Abilities: Fast healing (1D6×10 M.D.C. every hour), keen senses (equal to augmented bionic hearing and sight),

nightvision 1000 feet (305 m), leap 20 feet (6.1 m) from a standing still position (double from a running start), swim 56%, climb 60% (cannot rappel) and prowl 60%.

Combat: Five attacks per melee.

Bonuses: +3 to initiative, +3 to strike, parry and dodge, +2 to roll with impact. All these are in addition to attribute bonuses.

Damage: Bite: 4D6 M.D. Claws: 1D6 M.D. plus P.S. damage.

Magic: None

Psionics: None

Average Life Span: 16 years in the wild, 26 if domesticated.

Languages: None

Value: 2D6×10,000

Habitat: Any. Can adapt equally well to jungle, forest, mountain, desert and even cities!

Enemies: Intelligent beings and other large predators.

Size: 4 feet (1.2 m) tall at the shoulder and seven feet (2.1 m) long.

Weight: 200 lbs (91 kg)

Lesser Ugglies

a.k.a. "Space Rats"

These hideous little creatures have spread through the Three Galaxies, carried by spaceships to every corner of the known universe. Dubbed "the space rats" by angry spacers who have to deal with periodic infestations of these nasty animals, the lesser ugglies look like little octopuses or squids. They have six tentacles, a pointed head, and one large and disturbingly humanoid eye. A few people have noticed a resemblance between these critters and the Splugorth race, and the ugglies' second nickname is "Splugorth babies."

The ugglies can survive in a vacuum for extended periods of time and can eat any organic or even vaguely organic material they can find (including most plastics and hydrocarbon products). They break their food down by secreting a powerful digestive enzyme that dissolves most materials into a disgusting goo which they then slurp down. This enzyme can even eat through plastic and ceramic M.D.C. materials! The ugglies' tentacles are made primarily for climbing and jumping (especially in zero-gravity), but they are strong enough to run in normal gravity. The sight of an uggly running with all six tentacles whipping back and forth, would be amusing if it wasn't for their disarming speed and the damage they can cause on starships and space stations. Ugglies are mostly dangerous to food supplies and cargo. A careless merchant ship may discover that their expensive goods have been reduced to unrecognizable blobs by a band of ravenous ugglies if they aren't careful.

The monsters are usually dangerous to humans in many indirect ways, like eating the food supply and space suits, destroying valuable property, damaging spaceships (especially hoses, wires, connectors and seals) and so on. However, if no other food is available, swarms of ugglies will rush and attack living things using the same enzyme to melt them down and eat them! One of the spacer's worst nightmares is to find himself trapped in a stranded ship (usually because the FTL drive was damaged by ugglies), while the ravenous creatures multiply and start running out of food.

Ships can be cleansed of ugglies by exposing the entire vessel to high-intensity bursts of radiation. This process requires that the ship be vacated of all personnel for 1D4 hours. The extermination service is provided at most space stations. However, even the most extreme measures never seem to get all the creatures, and there is always a 10% chance that the ugglies will come back in 1D6 months (raise by 2% per month after the first six). An irradiation treatment every six months will keep ships clean 99% of the time. The spaceports and space stations at Phase World are 99.6% clean of ugglies, however, there are occasional infestation problems on the lowest levels of Center.

Alignment: Considered to be anarchist scavengers, but most spacers and space mercenaries will tell you they are diabolic hell spawn.

Attributes: I.Q. 1D6, M.E. 2D6, M.A. 2D6, P.S. 2D6, P.P. 3D6, P.E. 3D6, P.B. 1D4, Spd. 3D6+6

Hit Points: 100 S.D.C./Hit Points (1 M.D.C. point). Can be damaged by S.D.C. weapons and attacks, but are still incredibly hardy for size.

Horror Factor: 6 for a lone individual, 12 if in a pack of more than 10 individuals.

P.P.E.: 25

Natural Abilities: Resistant to vacuums and don't need to breathe; able to eat through most materials if given enough time. They can also climb (80%/70%), prowl (45%) and squeeze through small openings and narrow spaces (they usually live between walls, in crawl spaces and sewers).

Combat: One attack per melee round. A swarm of 10 or more ugglies can attack four times per melee round.

Bonuses: +1 to strike on its own, +6 to strike in a swarm, +1 to dodge, +1 to roll with impact, and is impervious to poisons, drugs and disease.

Damage: The acid secretions of one uggly will do 1D4×10 S.D.C. damage to S.D.C. structures or 1 M.D. point to mega-damage structures. A swarm of 10 or more ugglies inflicts 1D4×100 S.D.C. or 1D4 M.D. per melee round.

Magic: None

Psionics: None

Average Life Span: 6 months

Languages: None

Value: None. Some cities pay a bounty of 500 to 1000 credits for every dead uggly brought to them, but only in places with severe infestations.

Habit: Ocean vessels, spaceships, space stations, and the sewers, alleys, basements, garbage dumps and filthy areas of cities and towns. They eat all sorts of organic waste, rubber, plastics and non-metallic M.D.C. materials.

Size: 2 to 4 feet (0.6 to 1.2 m) tall with tentacles that can reach four to six feet (1.2 to 1.8 feet).



Note: They are shy scavengers who avoid hunting living prey unless they are starving and there is no other food source. Thus, they are usually easy to shoo away, but represent a serious danger to the eco-systems of contained, artificial environments like spaceships.

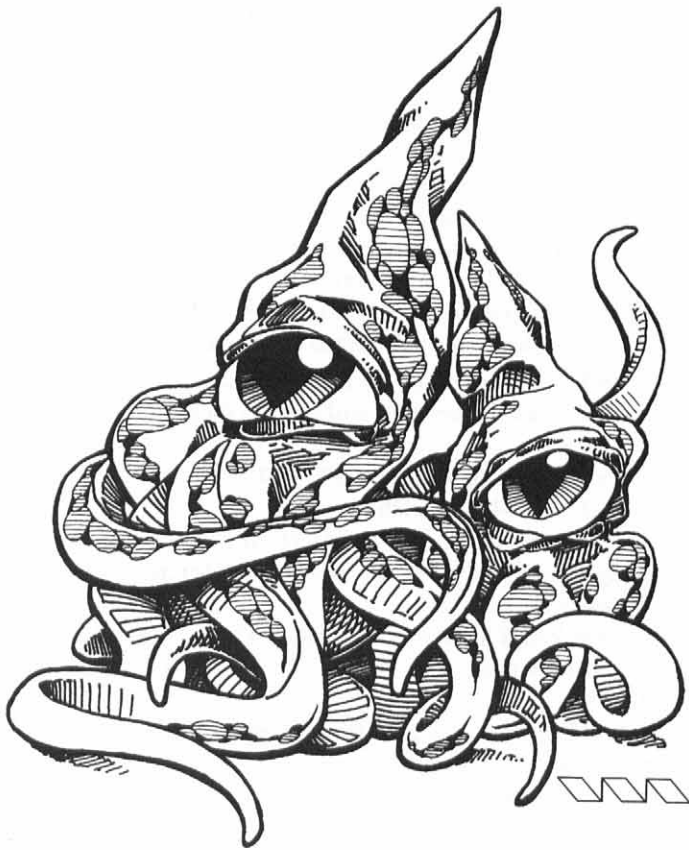

Vampire Uggies

a.k.a. “the Spacer Plague”

The bogie-men of spacer legends, these creatures are almost identical to their “lesser” cousins in appearance, but unlike normal uggies, the vampires do not feed on garbage and inert matter, but on P.P.E., I.S.P. and the life force (P.E.) of intelligent beings! Vampire uggies can be very dangerous. They cannot be killed by bursts of radiation and they feed carefully and unobtrusively. At first, crew members will feel tired, edgy and short-tempered. Then, one or two of them will get sick (when their P.P.E. or I.S.P. is siphoned to zero) and may even fall into a coma and die (when their P.E. is drained by the vampire). Traditionally, if people start feeling funny, spacers will automatically assume that vampire uggies are around and start searching for them.

Fortunately, these critters are not very common. Nobody knows where they come from and why they look exactly like the lesser uggies. Some think they are a mutation of the uggie race, while others believe these are actually “Undead” uggies. Whatever they are, they are very hard to kill and can be deadly when cornered. Sometimes, one or two vampire uggies will hide among a swarm of lesser uggies. The vampires have never been found in groups of more than six members.

Alignment: Considered to be diabolic.

Attributes: I.Q. 2D6, M.E. 2D6+6, M.A. 2D6+6, P.S. 3D6, P.P. 4D6, P.E. 4D6+3, P.B. 1D4, Spd. 4D6

M.D.C. by Location: 1D4×10 M.D.C.; unlike lesser uggies, they cannot be harmed by S.D.C. attacks.

Horror Factor: 10

P.P.E.: 1D6

Natural Abilities: Steal life force: The vampire uggie can steal the life force of intelligent living beings. It usually targets one person and uses its siphoning powers only on him. Researchers think that the uggies get a “taste” for one individual at a time. Once a day, the victim must make a save vs psionics. A failed roll means he is drained of 1D4 P.P.E. or I.S.P.; points drained by the vampire uggie do not regenerate until the character can get away from the creature, or the monster is slain. When the P.P.E. and/or I.S.P. are gone, the person feels too weak to work at full capacity; reduce all skills by 20% and all melee attacks and bonuses by half. Next the vampire begins to draw on P.E. points. When P.E. is reduced to 0, the victim will lapse into a coma (-20% to save). Death is inevitable unless the vampire can be found and slain or the character removed from the ship/area (miles away). Symptoms of life force draining include short temper, chronic fatigue, weakness and sleeplessness often accompanied by nightmares. It is sometimes difficult to tell vampire draining from the effects of claustrophobia and other problems associated with space travel.

Combat: Three physical attacks per melee. It is a solitary predator and never attacks in swarms. Like its cousin, the vampire uggie tends to avoid direct contact with its prey and usually fights only when cornered.

Bonuses: +4 to strike and dodge.

Damage: Bite inflicts 1D6 M.D., lashing tentacle inflicts 3D6 S.D.C.

Magic: None

Psionics: None, other than the life drain. Psionic powers like sense evil and presence sense will detect the creature and can be used to track them down.

Average Life Span: Unknown

Languages: None

Value: None. Nobody can tell a vampire uggie from a lesser uggie, so any bounties would be the same for both.

Habitat: Same as the lesser uggies; spaceships, space stations and cities.

Killer Apes

Killer apes, also known as the Forsaken Ones, are a race of gorilla-like creatures that can be found on several planets of the Corkscrew Galaxy. Their existence usually coincides with some ancient ruins of once-mighty cities, which has led many scholars to suggest that these beings are the devolved descendants of an ancient starfaring race. A few fringe cults actually believe that these creatures are the bastard children of the mythical First Race and they will capture the apes to worship them as living gods!

Like Earth apes, the Forsaken Ones have overly long arms and massive builds. They are covered with long, fine hair, usually white or beige, that hides their faces and features as well as the outlines of their bodies. Unlike real apes, the killers are ferocious carnivores who are not afraid to kill for food, or to protect their territory. Some rogues even kill for pleasure. An adult bull ape can tear apart a man in seconds, and even rip out an arm protected in mega-damage body armor. Entire colonies of humanoids have been wiped out by large tribes of killer apes that swooped down on them when they least expected it (often at night, while they sleep).

Alignment: Considered to be diabolic predators.

Attributes: I.Q. 2D6 (high animal or low humanoid), M.E. 3D6, M.A. 2D6, P.S. 4D6+20, P.P. 2D6+10, P.E. 2D6+10, P.B. 2D4, Spd. 4D6; supernatural strength and endurance.

M.D.C.: 1D4×100 M.D.C.

Horror Factor: 12 when facing a lone individual, but 17 when one or two characters are facing down five or more.

P.P.E.: 2D6

Natural Abilities: Night vision 200 feet (61 m), keen sense of smell (track by smell 59%, track the scent of blood 72%), track by sight 54%, climb 60%/50%, prowl 50%, swim 60%, and bio-regenerate 3D6 M.D.C. per hour. Many have a high animal intelligence and exhibit extreme cunning, sneakiness and resourcefulness. They can figure out how to open doors, turn on lights, activate (but not run) machines and vehicles, and even use tools and energy weapons (-4 to strike). Despite

this, they CANNOT be domesticated and are murderous predators.

Combat: Four hand to hand attacks per melee round.

Bonuses: +1 on initiative, +4 to strike, +5 to parry and dodge, +2 to roll with impact or fall, and +3 to save versus magic and psionics. All are in addition to attribute bonuses.

Damage: Claws: 1D6 M.D. plus supernatural P.S. or by bite which inflicts 2D6 M.D.

Magic: None

Psionics: None

Average Life Span: 50 years; twice as long in captivity.

Languages: Believed to have a crude language consisting of grunts and gestures.

Value: Some zoos and circuses will pay 2D6×100,000 credits for a baby killer ape, and 4D6×100,000 for an adult.

Habitat: Jungles and forests.

Size: Five to six feet tall (1.5 to 1.8 m)



Weapons and Technology

Listed below are some weapons and equipment common to the Three Galaxies. More technological and magic items will be described in future Phase World sourcebooks. The *After the Bomb/Rifts supplement Mutants in Orbit* also has a number of weapons and pieces of equipment for a campaign in space.

Keep in mind that the technological level of the major civilizations in the Three Galaxies is at least a century ahead of anything produced by Earth cultures, especially in regard to spaceships, space travel, force fields, and medicine. Earthlings, even those on the moon, have yet to discover a faster-than-light (FTL) drive or a contragravity propulsion system, among other things. Game Masters may wish to use the equipment in **Mutants in Orbit** to simulate more primitive civilizations in the Three Galaxies, especially poor ones that have to make do with what they can manufacture themselves, or isolated ones who have had little or no contact with their more advanced neighbors.

Note: Although the technology of the Three Galaxies is superior to what is found on Rifts Earth, the difference in weapon quality and performance is not as great as one might think it should be. Why? The reason is simple. Unlike the cultures of Rifts Earth, the most advanced civilizations of the Three Galaxies are not fighting for their very survival against hordes of super-powerful monsters. Innovation has stagnated, weapon systems that were in use several centuries, or even a thousand years ago are still being used, because they work well and to replace them with slightly superior weapons would be more expensive than performance improvements would justify. On the other hand, the Coalition States and the NGR/Triax have poured billions of credits into frenzied efforts to improve their war machines. In a hundred years they have closed the general technological gap between them and the thousand year old cultures of the Three Galaxies to a “mere” century or two. In another hundred they might become their equals — if their inhuman enemies don’t destroy them first.

Generally speaking, the high-tech powers of Rifts Earth are much closer to the Three Galaxies’ (within 10 to 20 years) in regard to robots, power armor, bionics, weapons, and techno-wizardry, although there are some civilizations that surpass them by 50 to 100 years in those areas as well, but these are the exceptions, not the rule. Many robots, vehicles and weapons produced by Rift Earth’s Triax Industries, the CS, Wilk’s and other manufacturers can be purchased on Phase World! They often see service in the most unlikely places of the Three Galaxies. The freedom fighters of the Transgalactic Empire, for example, favor NGR weapons because they are effectively untraceable by the authorities and of very good quality. Glitter boys of the original design, the new Triax version and space models (see **Mutants in Orbit** for the latter) can be found throughout the Three Galaxies, particularly in the hands of spacers, pirates, freedom fighters and mercenaries (about 25% have an additional 2D4×10 M.D.C. and use an additional or different weapon).

The Splugorth and their minions, (especially the kittani), also do a brisk trade in high-tech weapons and vehicles, both on Phase World and on the planets they control. All items described in Rifts Atlantis can be found on those worlds. Kittani technology is respected, but not feared. Both the CCW and the Transgalactic Empire can produce weapons and vehicles with the same or even better performance. Besides the large planetary federations, the largest weapon producer in the Three Galaxies is the transdimensional company *Naruni Enterprises*. However, when it comes to rune weapons and bio-wizard devices, the Splugorth remain unsurpassed. These “unique” items are sold on a very limited basis, at very high prices, to a specialized market (namely practitioners of magic and supernatural beings).

Weapons from Aliens Unlimited: The *Aliens Unlimited sourcebook*, for *Heroes Unlimited* and *Rifts*, offers a nice selection of strange and unique weapons, including microwave guns, sonic blasters, cold weapons, stun weapons, projectile shooters, energy blades, and vibro-blades as well as body armor, power armor, special armor features, vehicles and spaceships. Most are listed with S.D.C. damage. It is fair to assume that weapons used in any **Rifts** setting that were created by a high-tech civilization such as those of the Three Galaxies would incorporate mega-damage technology and inflict mega-damage.

Quick Alien Unlimited Conversions: Simply turn the S.D.C. damage points into M.D.! Thus, if a weapon does 6D6 S.D.C., the **Rifts/Phase World equivalent** would do 6D6 M.D. Game Masters may want to reduce some of the weapon’s damage by 1D6 or 2D6 and range by 25% to 50% to make them fit with other comparable **Rifts** weapons; as advanced S.D.C. weapons, some inflict considerable amounts of S.D.C. damage. The only exceptions are conventional firearms (pistols, rifles, machineguns, etc.) and stun weapons; these remain S.D.C. items. Stun weapons will not work against supernatural beings and may do little or no damage to mega-damage creatures (25% of normal damage, penalties and duration to those with less than 120 M.D.C., nothing to beings with 200 M.D.C. or more). In the alternative, the G.M. can use the weapons from *Aliens Unlimited* exactly as listed (S.D.C. weapons) and consider them to be items from an alternative dimension with lower technology.

Of course, the weapons, equipment, giant robots, power armor and spaceships from any of Palladium’s other mega-damage game worlds can also be incorporated (as is, or modified) into the **Rifts/Phase World** setting.

Weapons

HI-30 Laser Pistol

High-intensity lasers are the most popular handguns in the CCW and can also be found on many of the independent worlds. The HI-lasers fire laser beams on a higher wavelength than those of normal lasers for greater penetration. These weapons are more powerful than lasers manufactured on Rifts Earth (Triax Indus-

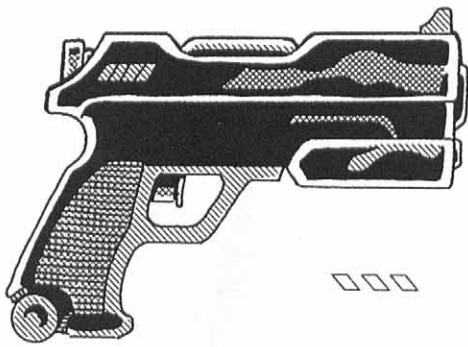

tries might be able to manufacture HI lasers if given enough prototypes or time). **Note:** All prices reflect Three Galaxy Universal credits, not Earth credits.

The HI-30 is a short-barreled, square pistol that looks like a cut-down Colt .45. It is light and easy to conceal, making it a favorite among bodyguards and assassins. The thickness of the barrel is due to a cooling system that keeps the barrel from melting.

Weight: 2 lbs (0.9 kg)

Mega-Damage: 2D6 M.D.

Rate of Fire: Standard

Effective Range: 1000 feet (305 m)

Payload: 20 shots

Cost: 15,000 credits for the pistol; a standard E-Clip is 2,000.

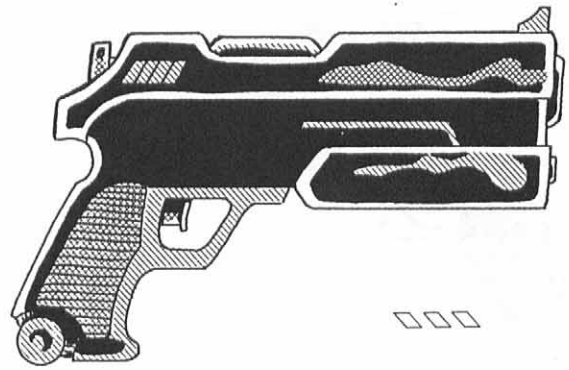

HI-10 Heavy Laser Pistol

This handgun looks like an oversized .45 pistol and is the standard issue weapon of the Consortium Armed Forces (CAF). Like all high-intensity lasers, the weapon has more penetrating power.

Weight: 3 lbs (1.1 kg)

Mega-Damage: 3D6+3 M.D.

Rate of Fire: Standard

Effective Range: 1000 feet (305 m)

Payload: 15 shots

Cost: 18,000 credits

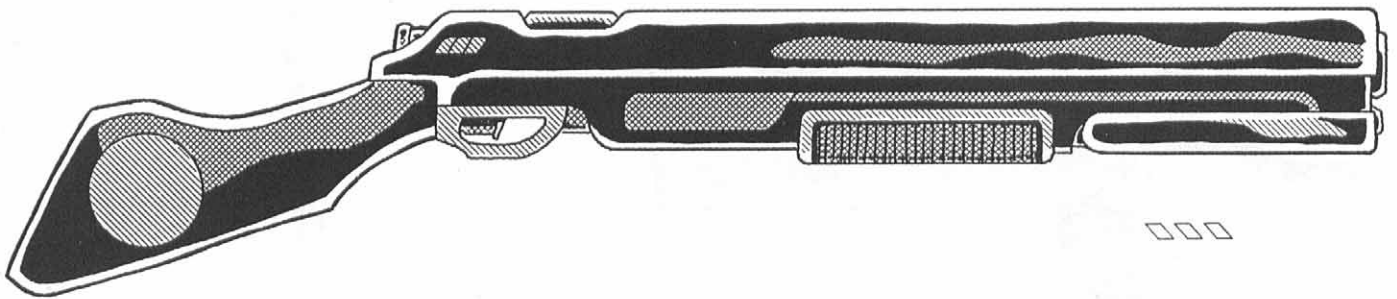

HI-50 Laser Rifle

A rifle version of the HI-30. This short gun resembles a square-shaped shotgun and has the characteristically thick barrel common to high-intensity lasers. HI-50s are often found in the hands of the freedom fighters of the Transgalactic Empire, purchased from gun smugglers that usually come from CCW planets.

Weight: 5 lbs (2.25 kg)

Mega-Damage: 3D6+6 M.D. single shot or 1D6×10+10 M.D. from a multiple pulse burst (three simultaneous shots; counts as one melee action).

Rate of Fire: Standard

Effective Range: 2000 feet (610 m)

Payload: 30 shots

Cost: 26,000 credits for the weapon; a standard E-Clip is 3,500.

HI-80 Combat Laser Rifle

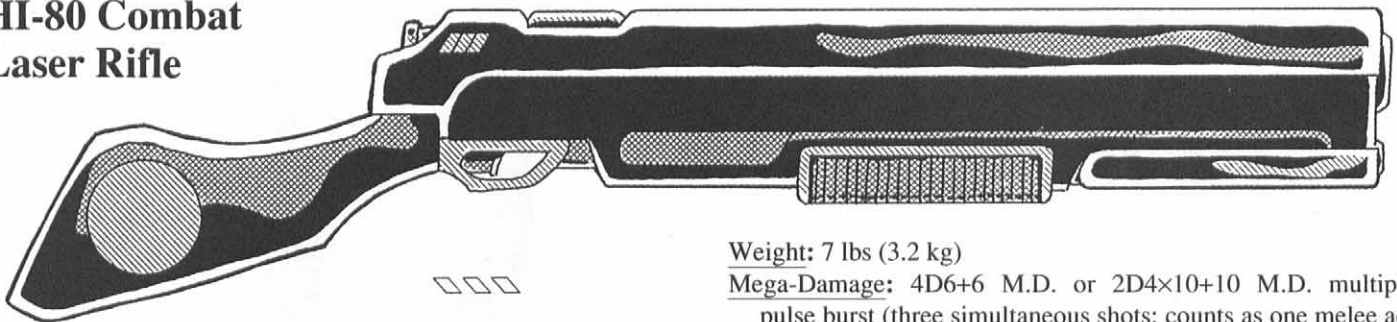

This weapon is only slightly bulkier than the HI-50, but it is able to fire a more powerful beam. The HI-80 is the standard issue infantry weapon of the CAF and has been adopted by many armies throughout the Three Galaxies.

Weight: 7 lbs (3.2 kg)

Mega-Damage: 4D6+6 M.D. or 2D4×10+10 M.D. multiple pulse burst (three simultaneous shots; counts as one melee action).

Rate of Fire: Standard

Effective Range: 2000 feet (610 m)

Payload: 30 shots

Cost: 40,000 credits

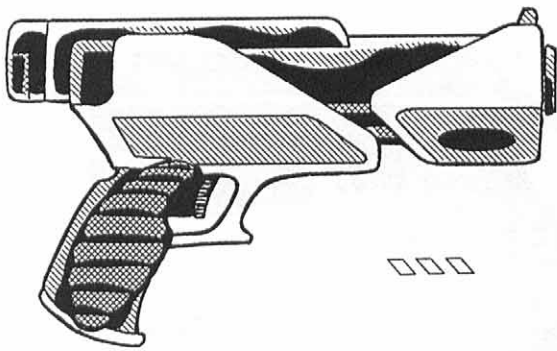

EP-5 Energy Pulse Pistol

These guns fire brief but intense bursts of charged particles. To an observer, the weapon seems to spit small balls of white flame that explode on contact with a solid object. Pulse guns have respectable stopping power and good range. The Transgalactic Empire line troops use E-Pulse weapons almost exclusively.

Weight: 4 lbs (1.8 kg)

Mega-Damage: 3D6 M.D.

Rate of Fire: Standard; single shots only.

Effective Range: 1000 feet (305 m)

Payload: 9 shots

Cost: 10,000 credits

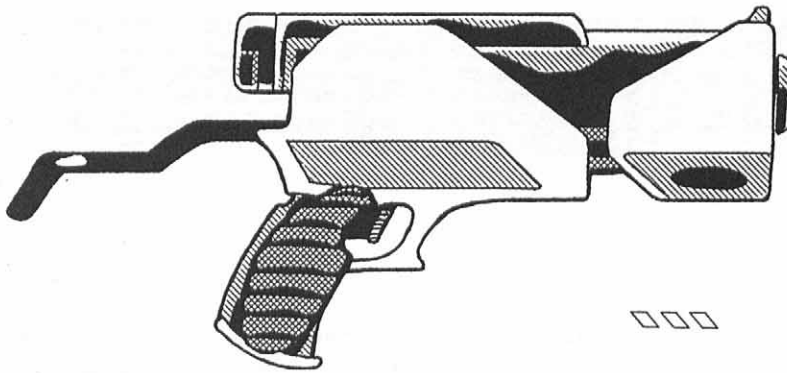

EPR-8 Energy Pulse Rifle

The standard issued weapon of the Transgalactic Empire's Imperial Armies. A relatively short weapon that resembles a carbine or sub-machinegun, but which can fire devastating automatic bursts. The weapon is very sturdy and can survive a lot of abuse and field service under extreme environmental conditions. Due to this, the EPR-8 pulse rifle is also a popular item among explorers, colonists and mercenaries.

Weight: 13 lbs (5.8 kg)

Mega-Damage: 5D6 M.D. for a single shot or 1D6×10 M.D. for a 4-shot burst.

Rate of Fire: Single shots or short bursts only.

Effective Range: 1600 feet (488 m)

Payload: 40 shots

Cost: 23,000 credits

Power Halberd

A fearsome melee weapon, the power halberd is a heavy blade connected to a power supply worn on the back. When activated, the halberd's ultra-hard blade starts vibrating at a very high frequency. The powered blade can slice through any material, easily cutting through power armor, M.D.C. walls, vehicles,

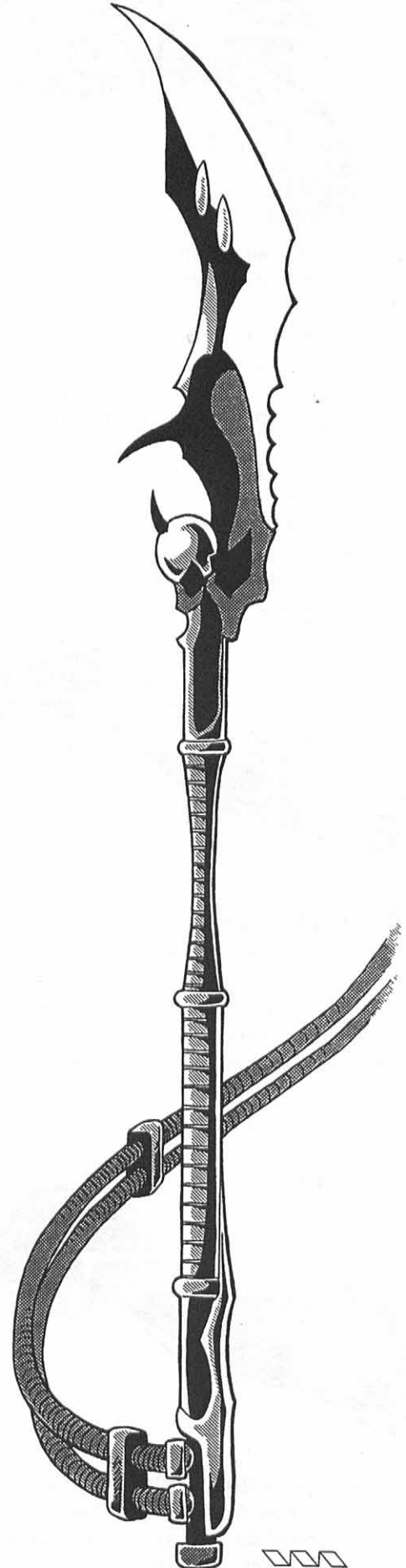

etc. The power halberd must be used with two hands and is a clumsy, heavy weapon:

-2 to strike and parry unless they are wielded by somebody with a P.S. of 24 or higher, or is using power armor, or has supernatural P.S. of 20 or higher.

Note: This weapon was first depicted (but not described) in the Rifts Dimension Book One: Wormwood.

Weight: 40 lbs (18 kg)

Mega-Damage: 1D6×10 M.D. when powered up. 4D6 S.D.C. otherwise.

Rate of Fire: Equal to the number of hand to hand attacks.

Effective Range: Melee weapon

Payload: Powered by an E-Clip for 2 hours of continual use.

Cost: 20,000 credits.

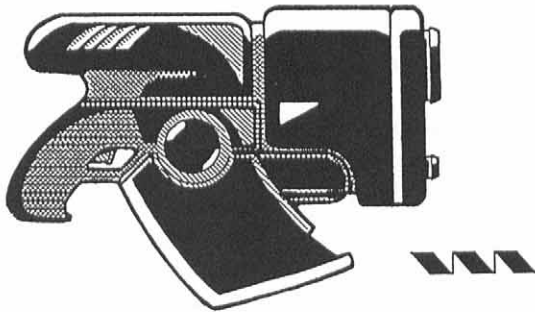
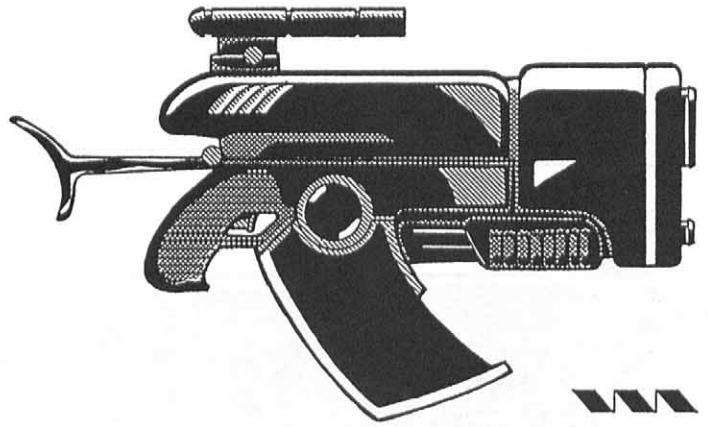

NE-4 Plasma Cartridge Pistol

The pistol version of the NE-10; it fires the same cartridges (same damage but reduced range). It is very heavy and cumbersome for a pistol, but fans of firepower love it. Has no auto-fire capability. Characters with a P.S. of 17 or less are -2 to strike even on an aimed shot.

Weight: 6 lbs (2.7 kg)

Mega-Damage: 1D4×10 M.D.

Rate of Fire: Standard

Maximum Effective Range: 500 ft (152 m)

Payload: 10 shot magazine.

Black Market Cost: 25,000 credits for the gun. Each round costs 40 credits (a full magazine costs 400 credits).

NE-10 Plasma Cartridge Rifle

This weapon is an energy rifle that does not require an E-Clip. Instead, it uses thick cartridges that have a small impact primer. When the primer is hit by the mechanical weapon, the cartridge is converted into energy, causing a plasma discharge. The weapon inflicts a lot of damage, but has a limited range. Its main drawback is that the ammunition must be purchased from Naruni Enterprises. However, NE has licensed several companies through the Three Galaxies to produce plasma cartridges, so there is an ample supply of ammo available.

The gun's bore is almost two inches wide — having it pointed your way is very intimidating.

Weight: 20 lbs (9 kg)

Mega-Damage: 1D4×10 M.D. per single shot.

Rate of Fire: Standard

Maximum Effective Range: 1200 feet (365 m).

Payload: 20 shot Magazine.

Black Market Cost: 40,000 credits for gun. Each round costs 40 credits (a full magazine costs 800 credits).

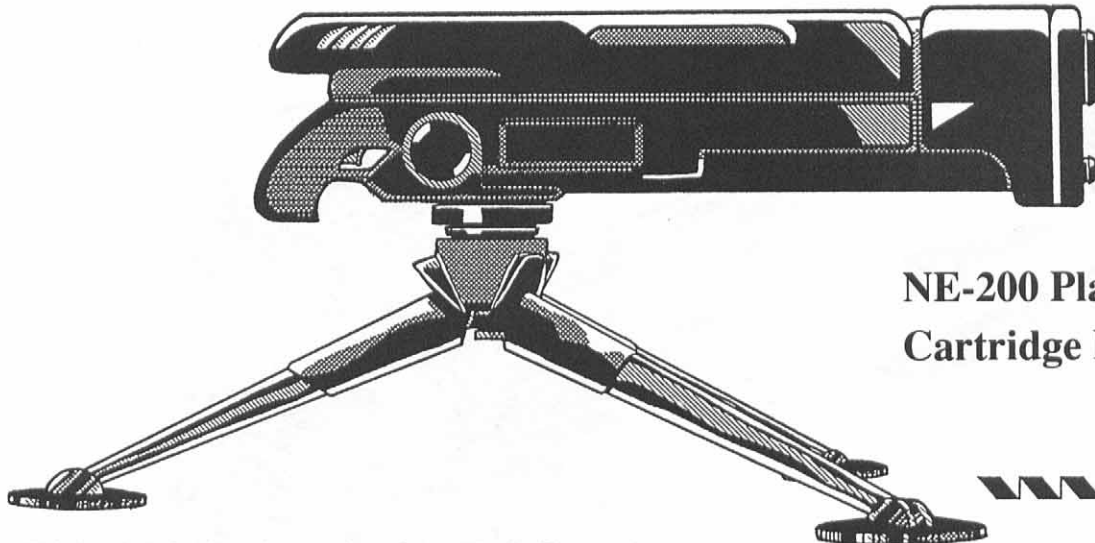

NE-200 Plasma Cartridge Machinegun

This is a belt-fed, heavier version of the NE-10 rifle, used as a tripod or vehicle-mounted weapon. There is also a power armor/cyborg version, used as an oversized rifle (that model has a 40 shot magazine). The user must have a P.S. of 24 or greater.

Weight: 70 lbs (31.7 kg) with magazine. The belt weighs another 15 lbs (6.8 kg).

Mega-Damage: 1D4×10 per single shot, or 2D6×10 M.D. for a burst of 10 shots.

Rate of Fire: Standard

Maximum Effective Range: 2000 feet (610 m)

Payload: 200 shot belt or 40 shot magazine.

Black Market Cost: 95,000 credits. Each round costs 40 credits (a full magazine costs 1,600 credits, and a belt costs 8000 credits).

NE-50 Particle Beam Rifle

A heavy energy rifle that has been "modified" to operate on Earth type "E-clips."

Weight: 13 lbs (5.9 kg)

Mega-Damage: 1D4×10 M.D per blast.

Rate of Fire: Standard

Maximum Effective Range: 1200 ft (365 m)

Payload: 8 shots from a standard "short" E-clip or 16 from a long E-clip..

Black Market Cost: 45,000 credits.

Note: The NE-50 (unmodified) particle beam rifle sold in other dimensions has a range of 1600 feet (488 m) and an NE energy clip can fire 24 shots; same damage. This weapon has not been offered to the Earth market yet, but may be used by some of the sales reps.

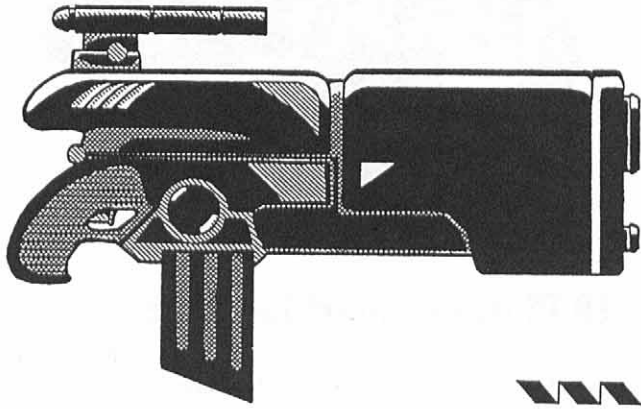

CAF Repeating Rocket Launcher

CAF infantry platoons are issued one Repeating Rocket Launcher System (RRLS). This weapon is basically a bazooka-like tube with a revolving drum magazine containing four mini-missiles. The weapon is relatively light and compact and can be quickly reloaded with disposable missile cassettes. Copies of these weapons can be found in the hands of mercenaries, guerrilla fighters and pirates.

Weight: A fully loaded launcher weighs 21 lbs (9.45 kg). Each preloaded cassette of 4 missiles weighs 5 lbs (2.25 kg). The

cassettes are relatively bulky and only four or five can be comfortably carried by most humanoid soldiers. Typically, every member of a platoon carries a reload for their missileer.

Mega-Damage: Varies with missile type (see *Rifts*, page 46).

Rate of Fire: 2 shots per melee. Reloading from a cassette takes one melee round for a trained person or 1D6 melees for an inexperienced user.

Effective Range: About one mile (1.6 km).

Payload: Four mini-missiles.

Cost: 20,000 credits for the launcher. Each cassette costs 1,000 credits plus the cost of the missiles (1000 to 2,200 credits each; see *Rifts*, page 204).

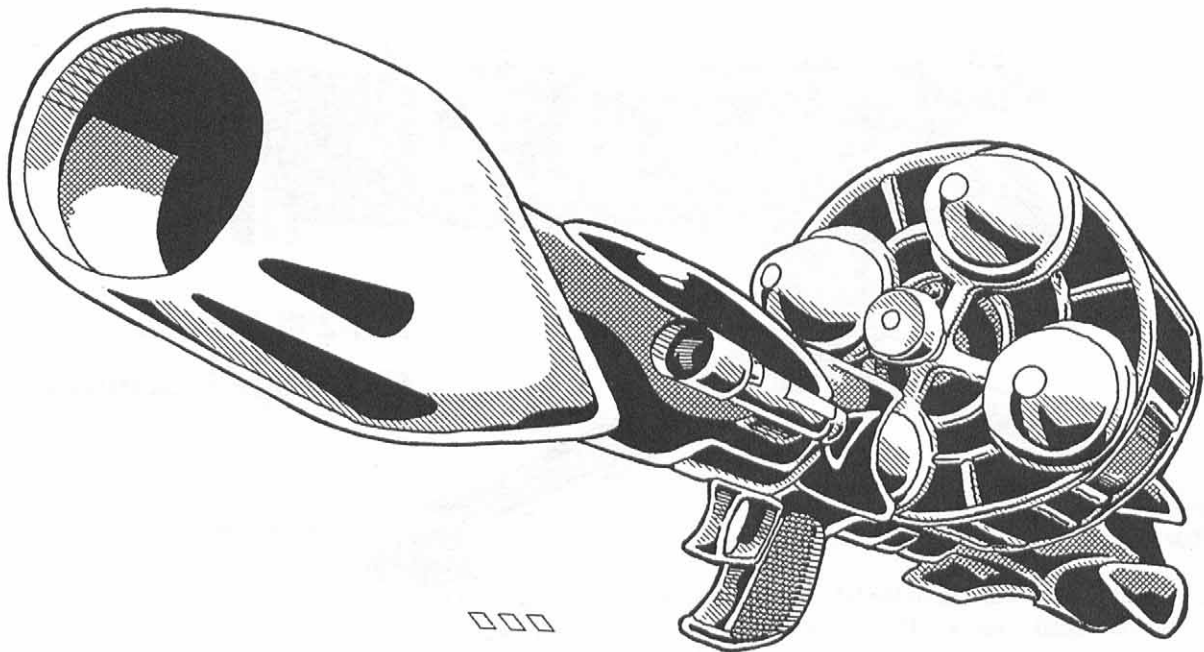

Body Armor & Spacesuits

Note: Unless otherwise noted, the body armor suits described below are designed for survival in the vacuum of space and offer fair to good protection against radiation, solar flares and other common space dangers. They also offer full environmental protection and have a limited (one hour or less) air supply, which can be augmented by adding oxygen tanks and/or air purification and recirculation systems (25,000 credits).

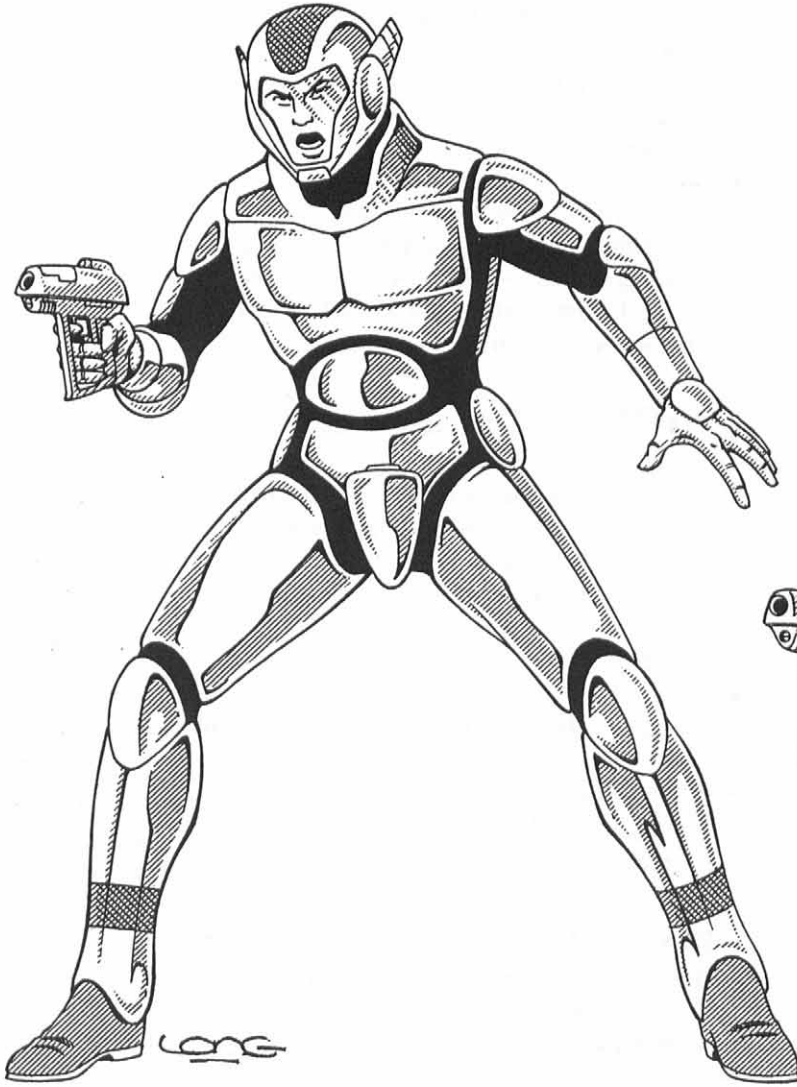

Light Combat Armor

This is a jumpsuit with special plate inserts on the chest, forearms and knees, and a helmet with transparent face plate. People from Rifts Earth will see a similarity to the plastic-man body armor, but this model uses high-tech composite ceramics and alloys that are far stronger. The LCA is commonly worn by private security forces, the armies of many independent planets, and a number of adventurers and pirates.

- M.D.C.: 80
- Weight: 18 lbs (8.2 kg).
- Good mobility: -10% prowl penalty.
- Colors: Varies. Most planetary forces favor olive green, brown or camouflage pattern. Any color imaginable can be put on the suit.
- Fits: This suit is designed for humanoids 4 to 9 feet (1.2 to 2.7 m) tall.

Market Cost: 30,000 credits.

CAF Jumpsuit

The Consortium's Armed Forces uniform is a form-fitting jumpsuit. The suit's material is made of a special fiber-metal composite that is very resistant to energy and which becomes ultra-hard when hit by a high velocity object (a bullet, for instance). The jumpsuit also has attachments that allow the wearer to put on a helmet and gloves that provide full environmental protection. Although this suit is not intended to be used in combat situations, black market suits are often worn by criminals and adventurers.

The suit can be designed for a number of different shapes and can accommodate wolven (although they dislike the "tail pockets" of the suits and constantly complain about them), noro and even less humanoid races.

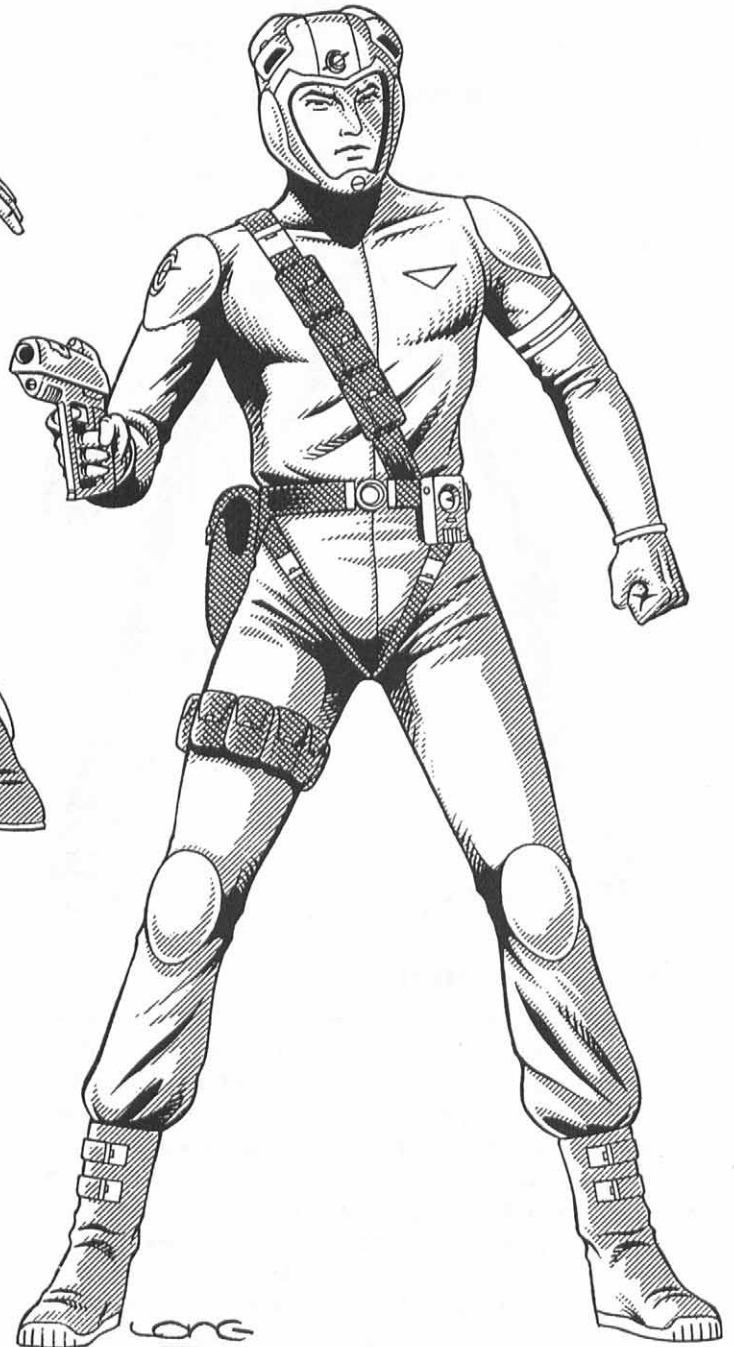

- M.D.C.: 25
- Weight: 12 lbs (5.4 kg).
- Great mobility: -2% prowl penalty.
- Colors: Blue with white trimmings. Rank is denoted by the a white-stripe design over the torso and shoulders. Rank symbols can be found under the CAF-related O.C.C.s.

Market Cost: 20,000 credits.

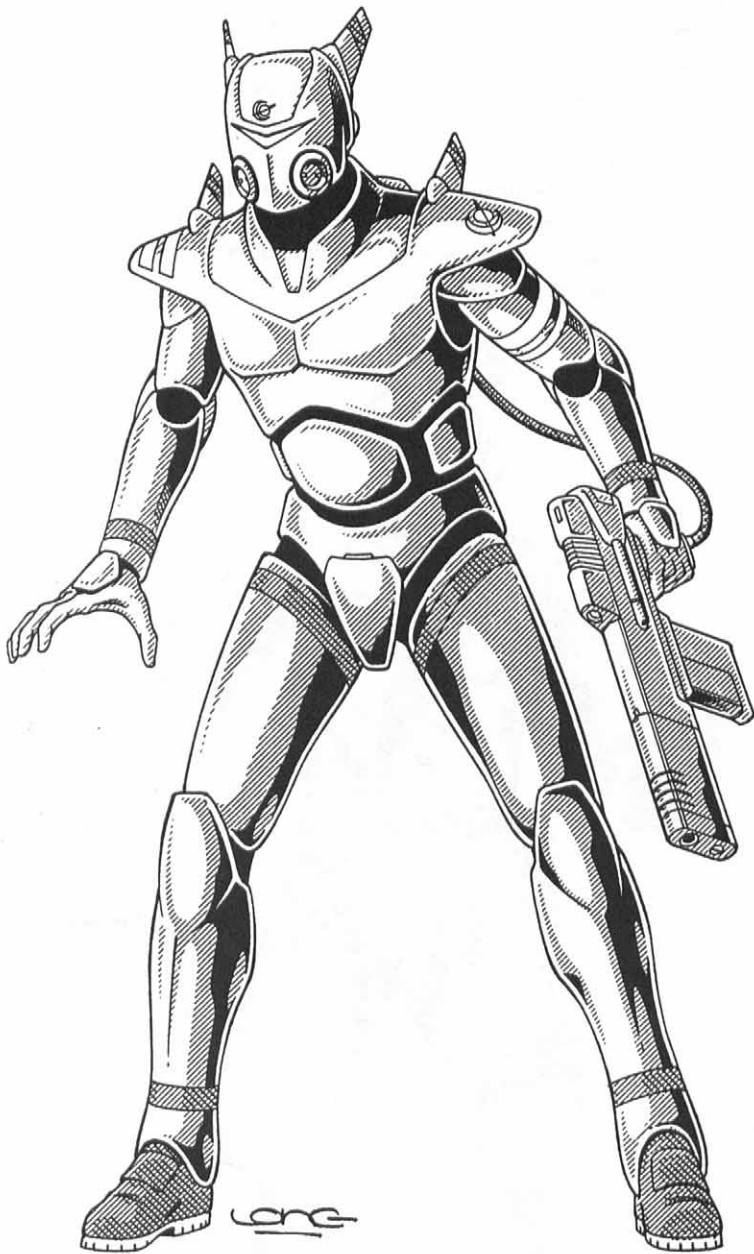

CAF Battle Armor

The Consortium's Armed Forces standard issue combat armor consists of articulated plate armor and full helmet. These armor suits have an angular, aerodynamic style and are designed to provide maximum protection and mobility; a hard combination to achieve. The armor even has an optional power backpack. This "backpack" looks like a thick plate on the back of the armor and does not protrude or weigh enough to hinder the wearer. Energy weapons with special power cords can draw power from the backpack, allowing for more capacity. The backpack holds 10 times the energy of a standard E-clip, so a weapon connected to the pack has ten times the normal payload! The disadvantage is

that if the backpack is destroyed, the weapons are effectively useless (most soldiers carry a normal supply of E-clips just in case).

The armor suit also has "stealth" materials that block out the wearer's heat signature and "blend" in with the heat signature of the local terrain. This means that thermographic nightvision systems are worse than useless to detect troops wearing this armor. In addition to the normal armor accessories, the helmet has a laser-communicator that allows for secure voice communication that cannot be intercepted. However, it only works by line of sight and the laser beam is blocked by most obstacles, including thick smoke.

- M.D.C.: 100 (Power Backpack has 40 M.D.C.)
- Weight: 21 lbs (9.5 kg), or 25 lbs (11.3 kg) with backpack attachment.
- Good mobility: -10% prowl penalty.
- Colors: Parade suits have the same color and pattern of the CAF jumpsuit. Field issued suits are colored to match the surrounding terrain — white for snow/ice, patchy green-brown for jungle/forest, yellow and brown for desert, and so on.

Market Cost: 70,000 credits.

CAF Heavy Battle Armor

A heavier version of the above, giving increased protection at the expense of greater weight and reduced mobility. This suit is often assigned to heavy weapon squads and to humanoid races with greater than average strength. Like the lighter version, the suit also has a slot on the back for a big energy backpack and all other accessories. Non-humanoid versions have roughly the same degree of protection.

- M.D.C.: 120
- Weight: 25 lbs (11.3 kg) or 30 lbs (13.6 kg) with power backpack.
- Fair mobility: -15% prowl penalty.
- Colors: Vary with terrain requirements.

Market cost: 80,000 credits.

Spacer Suit

This is a civilian spacesuit used in case of life support system failure or for working in a vacuum. In a pinch, it can serve as light body armor. The typical spacer suit is a "soft suit" made up of form-fitting, flexible super-plastics with a sealed helmet. The suit has a small supply of compressed oxygen and has fittings for extra oxygen tanks, jet packs and grav packs.

- M.D.C.: 20
- Weight: 10 lbs (4.5 kg)
- Great Mobility: -5% prowl penalty.
- Colors: Can be purchased in any color imaginable, including fuschia.

Market Cost: 10,000 credits

Spacer Hard Suit

This is a heavier version of the typical spacesuit. It is used for dangerous conditions (in the presence of solar flares, light particle showers, vacuum mining, and so on) or as a substitute for armor. The spacer hard suit is not a good substitute for real combat armor and is relatively bulky for the amount of protection it pro-

vides. On the other hand, it has a much more extensive life support system, enabling the wearer to survive in a vacuum for as long as a week (although not very comfortably).

- M.D.C.: 50
- Weight: 21 lbs (9.5 kg)
- Poor Mobility: -20% prowl penalty.
- Full Life Support: Enough food for a week and a two week supply of water (word command brings the food and water dispensers to the mouth of the wearer). Integral oxygen tank and recycling center (chemically extracts oxygen from the person's breathing wastes) will provide enough air for two weeks of activity, plus increased radiation, heat and cold shielding, temperature control, clock, mini-computer/calculator (left arm), radio communicator and other features.
- Colors: Typically white (easier to spot in an emergency), but can be any color.

Market Cost: 65,000 credits

Kreeghor Battle Armor

The kreeghor of ancient times wore mail and segmented armor to battle. A modern, fully-sealed version of this archaic armor, designed exclusively for the kreeghor race, is given to the Transgalactic Empire's troopers. Non-kreeghor soldiers make do with the lighter Imperial Combat Armor (see below). Kreeghor battle armor is perfectly articulated and offers no encumbrance to the super-strong race; its design is made so it fits the natural exoskeleton of the Kreeghor like a second skin and has an almost organic appearance.

- M.D.C.: 110
- Weight: 21 lbs (9.5 kg)
- Full Mobility: No prowl penalty.
- Colors: Dark gray or jet black with silver trimmings.
- Fits only members of the Kreeghor race.

Market Cost: 25,000 credits. Poor availability outside the Transgalactic Empire.

Imperial Legionnaire's Armor

This suit is issued to combat soldiers of the Transgalactic Empire. It is best known for its face mask which is sculpted to resemble the face of a snarling Kreeghor. The Legionnaire's armor provides good protection, and different versions are manufactured for all the major races in the Empire.

- M.D.C.: 90
- Fair Mobility: -10% prowl penalty.
- Colors: Dark gray only.

Market Cost: 30,000 credits. Poor availability outside the Transgalactic Empire.

Personal Force Fields

Naruni Enterprises deals in personal force fields, the latest development in personal defense technology. Unlike suits of armor, force fields are light and non-cumbersome (no penalty to prowl rolls). The force fields that Naruni Enterprises sells work by reacting to both energy beams and to fast-moving objects (like bullets and punches) by absorbing and dispersing the incoming energies. It is possible for an enemy to move slowly and press a weapon against the skin of the target without triggering

the force field, but this is easier said than done (such attacks are made at -6 to strike, unless the target is unable to move away — for example, if he's backed up against a corner or unconscious). The force field offers no protection against gases or hostile environments, including intense heat. A field wearer can drown if submerged in a body of water or burn to death if caught in the middle of a fire (unless he is wearing additional sealed armor or a spacesuit of some sort).

The M.D.C. value of the force field shows how close to overload it is. If the M.D.C. of the field is depleted, it has overloaded and cannot be reactivated for 12 hours. As long as the M.D.C. has not been overloaded, it regenerates lost M.D.C. at the rate of one M.D.C. point per melee round (4 M.D.C. per minute).

On the other hand, force fields need a source of energy. One E-Clip will keep force fields active for a period between 12 and 2 hours depending on the power of the field (see below). Naturally, this means that force fields cannot be left "on" all the time, but only when battle is imminent. This is a disadvantage over normal suits of armor.

It is NOT possible to wear armor under a force field, unless the field generator is built into the armor itself. Fields can be built into any M.D.C. armor suit or into powered armor at an extra cost (typically about 50% more than the normal cost for the field system). When connected to a nuclear reactor, the field can run indefinitely but is still subject to overload.

Robot models exist, but are a lot more expensive. There are equivalents of all Force Field Classes and they offer double the M.D. protection, but they cost 20 times as much as the integral force field models for powered armor.

N-F12A Light Force Field

This is the lightest model available and is worn as two crossed belts over the person's torso (the belts can be converted into bandoleers for grenades or E-Clips at no additional cost. Each bandoleer can hold 6 grenades or 4 E-Clips). The force field will run for 12 hours on one E-clip. Activating the field takes one melee action and protects the wearer immediately after activation.

There is an integral force field (the N-F12B) which can be built into any suit of M.D.C. armor or powered armor. The powered armor version uses no E-Clip and taps directly into the nuclear reactor of the suit. The robot model is twice as powerful, but much more expensive.

- M.D.C.: 45 (M.D.C. 90 for the Robot Model).
- Weight: 8 lbs (3.6 kg).

Market Cost: 25,000 credits for the personal field. 35,000 credits for the integral model; this includes installation cost, the armor must be bought separately. The Robot Model costs 700,000 credits.

N-20 (A or B) Medium Force Field

As above, but offering greater protection. An E-Clip will power the force field for 8 hours. Weight remains the same.

- M.D.C.: 75 (150 for the Robot Model)
- Weight: 10 lbs (4.5 kg)

Market Cost: 50,000 credits for the personal field (N-20A), 65,000 credits for the integral model (N-20B). The Robot Model costs one million credits.

N-40 Heavy Force Field

This force field requires a harness system and is slightly heavier than the N-12 or N-20. This is the usual limit for infantry force fields. An E-Clip will power the force field for only 4 hours of continual use.

- M.D.C.: 110 (220 for the Robot Model)
- Weight: 15 lbs (6.8 kg)

Market Cost: 90,000 credits for a personal field (N-40A), 130,000 credits for the integral model (N-40B). The Robot Model costs two million credits.

N-50 Superheavy Force Field

This is the most powerful force field available. It looks and weighs the same as the N-40 field, but is much more intense.

- M.D.C.: 160 (320 for the Robot Model)
- Weight: 15 lbs (6.8 kg)

Market Cost: 170,000 credits for a personal field (N-50A), 280,000 credits for the integral model (N-50B). The Robot Model costs five million credits.

Phase Technology

The prometheans have developed a unique form of technology (maybe techno-wizardry) that uses dimensional phasing as its base. Phase technology causes objects and people to “step out of phase” regarding the normal three-dimensional world. Depending on the intensity of the phase field, the subject can either be completely removed from normal space, or be only partially out of phase. The basis for all phase-tech is the phase field generator, which generates an unknown form of energy (commonly known as PH-waves) that surround the object and take it out of phase. The prometheans have used phase fields to create teleportation platforms, faster-than-light propulsion systems, ultra-powerful defensive barriers, and devastating weapons.

In the 100,000 years of galactic history, no civilization has been able to replicate phase technology. Not even transdimensional species like the Splugorth, uteni, or temporal raiders have successfully built a phase-tech device from scratch. Magic users and techno-wizards have found phase effects are impossible to reproduce. It is believed that the promethean’s natural ability to generate phase fields (see the *promethean R.C.C.*) is what enables this race to work with the delicate (and not quite three-dimensional) components of phase technology.

Since no nation or group can replicate, service or build phase-tech machines, most galactic governments are reluctant to depend on this technology. Most phase-tech is in the hands of relatively small groups like private corporations, mercenary companies, adventurers, pirates and smugglers. Possession of phase-tech is illegal in the Trans-Galactic Empire, except in the hands of the Imperial Guard. The CCW allows the sale and distribution of phase-tech with the same restrictions that apply to any weapon systems. A few independent planets have come to rely heavily on the technology and it is common to find phase vehicles and equipment among many of the non-aligned worlds.

Phase World is the capital of this technology, for obvious reasons, and it is the place where it can be purchased, repaired and serviced cheaply.

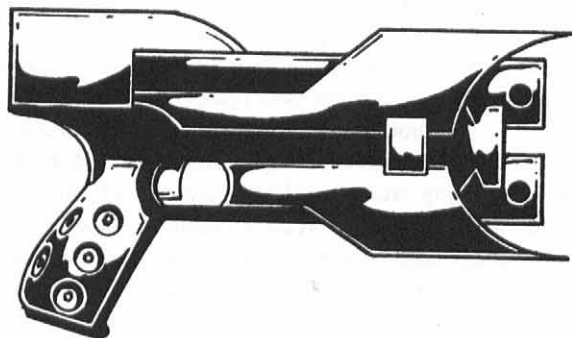

Phase Beamers

The phase beamer projects a phase field onto the target. This field disrupts the target’s vital functions, inflicting a great deal of damage. What makes the beamer so effective is that the field effectively bypasses any type of armor the target is wearing! Not only that, it affects both S.D.C. (normal humans, for instance) and M.D.C. creatures, inflicting roughly the same amount of damage. The field also disrupts the natural defenses and healing of its victims, including bio-regeneration. Even vampires and supernatural beings suffer from this weapon, because the energies that animates and/or empowers them are disrupted and dispelled.

Damage from a phase-beamer can be regenerated, but the recovery rate is much slower. Mega-damage that can usually be healed in a matter of melee rounds (seconds) takes the equivalent time in hours. Damage that normally heals in minutes takes the equivalent time in days. Damage healed in hours takes the equivalent time in weeks! Magic, psionic or technological healing works normally to restore these wounds.

Three things prevent the phase-beamer from becoming the most popular hand weapon of the Three Galaxies. First of all, it is useless against inanimate objects like walls, furniture, robots, vehicles, etc. The phase field is not disruptive enough to damage metals, and most other non-living things (note that living creatures, no matter what they are made of, still take damage). On the other hand, the phase-beamer is very popular on starships and space stations, because normal weapons blow holes in the walls and can kill everybody inside, but phase beamers only kill people and don’t damage the structural integrity of the vessel one bit. Pirates love these weapons, because they can use them to kill the crew of a ship or vehicle without harming the machinery.

Second, phase beamers are stopped by normal force fields. The beam does mega-damage to the force field but does not penetrate the protective field to damage those inside. Furthermore, it is completely useless against targets equipped with phase-fields (no damage/effect).

Third, the phase beamers are stopped by magic barriers the same as if they were force fields, including magic armor, magic invulnerability, energy field, impenetrable wall of force, id barrier, and magic walls (any). When it comes to magic protection circles (all), the beam stops at the perimeter of the circle and is rendered harmless!

PH-21 Phase Beamer

A pistol model phase beamer that is extremely popular among pirates, assassins, mercenaries, and adventurers.

Weight: 4 lbs (1.8 kg)

Damage: 3D6 S.D.C. to humans and other S.D.C. creatures; 4D6 M.D. to M.D.C. beings and force fields. It does not damage armor of any kind!

Rate of Fire: Equal to the total number of hand to hand attacks.

Effective Range: 400 feet (122 m)

Payload: 10 shots

Cost: 50,000 credits

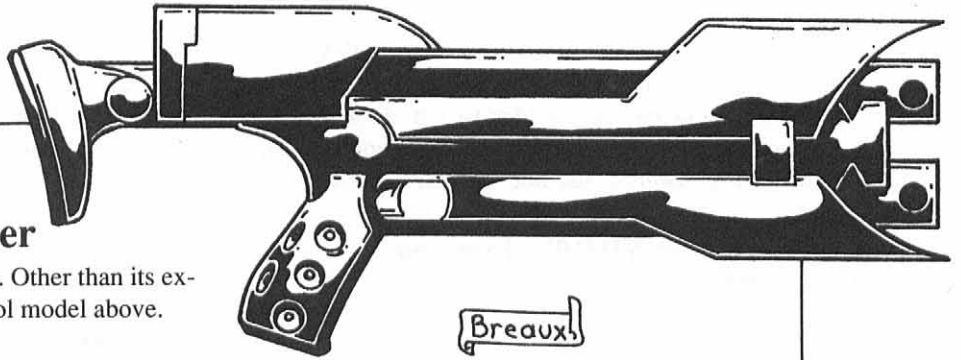

PH-100 Heavy Phase Beamer

The PH-100 is the rifle model of the PH-21. Other than its extra damage and range, it is identical to the pistol model above.

Weight: 7 lbs (3.2 kg)

Damage: 4D6 S.D.C. to humans and other S.D.C. creatures; 5D6 M.D. to mega-damage beings and force fields. Body armor is not damaged!

Rate of Fire: Equal to the total number of hand to hand attacks.

Effective Range: 800 feet (244 m)

Payload: 20 shots

Cost: 85,000 credits

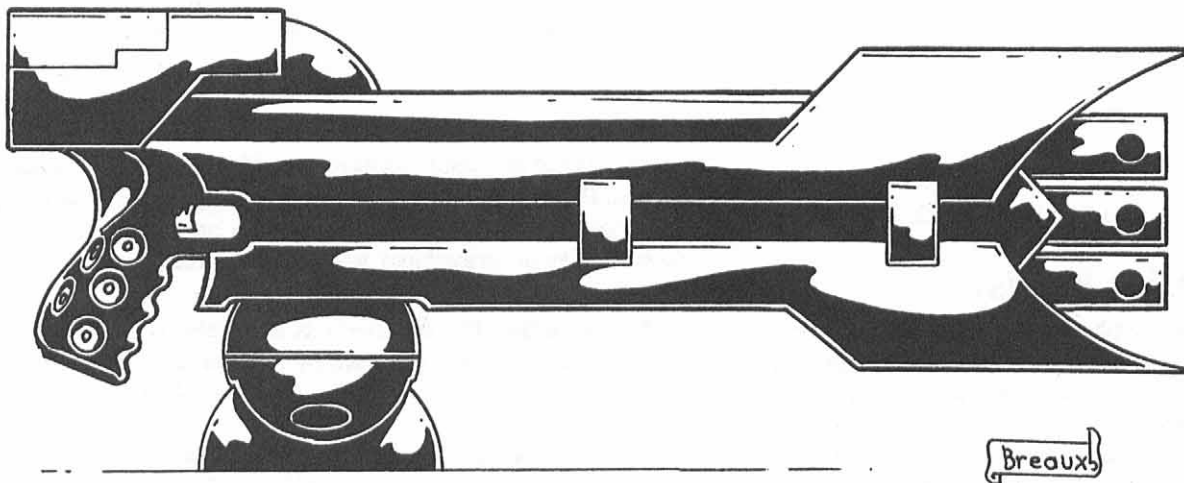

PH-400 Heavy Phase Beamer

This heavier phase beamer is used as a tripod-mounted support weapon or a light vehicle cannon. The PH-400 also has a rifle model used by giant creatures and robot vehicles. The cannon's effect depends on the size of the creature. The phase field affects a 10 foot (3 m) radius (that's a circular area that's roughly 20 ft/6.1 m in diameter), damaging all man-sized or smaller targets in the blast radius, OR two giant creatures 10 feet (3.0 m) or larger in that same area. In the latter case, the weapon does a lot more damage, disrupting the target's energies over a wider portion of his body.

Weight: 80 lbs (36.3 kg)

Mega-Damage or S.D.C.: 4D6 points of damage to all targets in a 10 foot (3 m) radius, or 6D6 to any creature 10 feet (3 m) or taller. Force fields also suffer 6D6 damage. This damage is S.D.C. to non-M.D.C. creatures, or M.D. to M.D.C. creatures and force fields.

Rate of Fire: Equal to the total number of hand to hand attacks.

Effective Range: 1600 feet (488 m)

Payload: 60 shots.

Cost: 180,000 credits

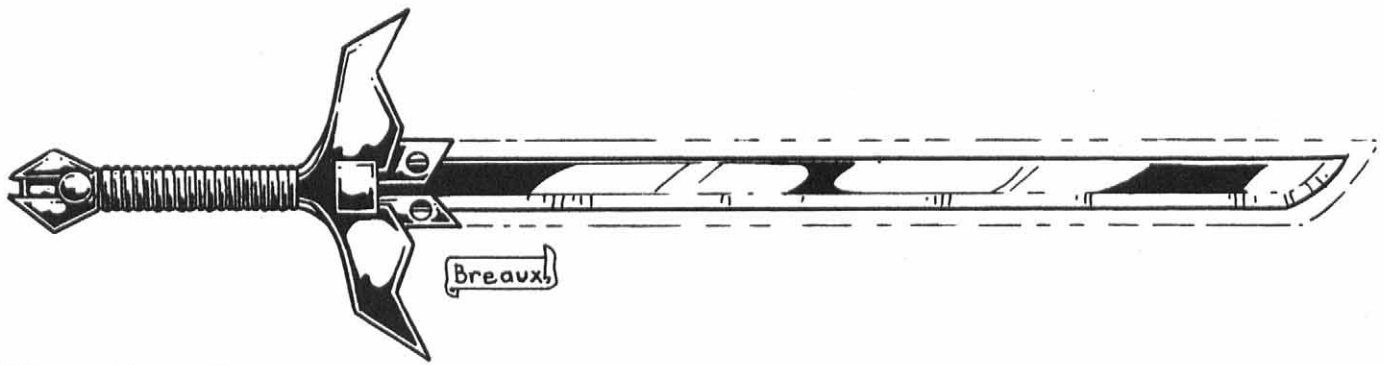

Phase Swords

These melee weapons consist of a high strength alloy blade surrounded by a phase field. The P-field disrupts both inanimate and living things, allowing the wielder to cut through even mega-damage alloys! Furthermore, the blade does damage to supernatural and M.D.C. beings, just like the phase beamers described above.

Damage: 4D6 M.D.C. or S.D.C./Hit Point damage, plus the wielders' P.S. bonus, if any.

Market Cost: 30,000 credits

Phase Fields

There are two types of phase fields, both of which use the same principle but are applied in different manners. The first type is the P-Field, a defensive field similar to a conventional force field. By creating an "out of phase" area around the user, the P-Field disperses incoming energy or physical attacks, reducing the damage they inflict.

The second type is the OP-Field which does not affect outside forces, but the wearer himself, taking him out of phase and effectively making him intangible and invulnerable to most conventional and energy weapons. The only drawback of the OP-Field is that the wearer must become tangible to counterattack.

Note: Magic and psionic attacks will penetrate both types of defenses and have full effect on the user of the phase fields.

P-Field (Defensive Fields)

This phase field projects a phase distortion around the wearer, dispersing any incoming energy attacks. The field is modulated to allow certain forms of energy (sunlight, slow-moving objects, etc.) to pass through and to allow the wearer to shoot through the field without penalty (in a manner similar to the way two-way mirrors work). Regrettably, the field does not disperse 100% of the energy attack, but a "mere" 90%. Furthermore, punches and kicks are slow-moving enough to get through the field unaffected. It would be possible to design a field that would disperse all energy, but the wearer would then find himself surrounded by an immovable black bubble, unable to move, see or hear through it.

The field projector can be worn as a harness with a projector on the front and back (each projector has 10 M.D.C.). Destroying one eliminates the field from one side. A battery supplies power to the field for 12 hours of continual use. The harness can be worn over light body armor (M.D.C. 50 maximum) or can be built into a suit of armor, at double the cost (the projector is destroyed when over half the M.D.C. of the armor is depleted).

Dispersal Effect: Protects the user from incoming energy blasts, beams of all kind, bullets, rail gun blasts, missiles and explosions by TEN. Simply roll for damage as usual, divide it by ten, and apply it to the hit points/S.D.C./M.D.C. of the character without armor or to the body armor of those wearing armor. Punches, kicks and melee weapons move too slow to be stopped by the field and do normal damage; parry or dodge or suffer damage.

Weight: The harness weighs 5 pounds (2.25 kg). The built-in version adds 6 pounds (2.7 kg) to a suit of armor.

Penalty: No prowling penalty.

Market Cost: 25,000 credits. Extra batteries can be purchased for 1,000 credits each.

OP-Fields (Out-of-Phase Fields)

The Out-of-Phase Field turns the wearer insubstantial. The character can walk through walls, but not force fields or magical barriers. Furthermore, he cannot be hurt by any non-magical attack, including physical attacks by most supernatural creatures. While in the out-of-phase state, the wearer cannot attack or affect physical targets.

OP-fields do not protect the wearer against magic or psionic attacks, which do normal damage even if the character is insubstantial. Phase beamers also do normal damage to the intangible character. Normal force fields (like those protecting most medium and large spaceships) will still be effective against the character.

Activating the OP-field counts as one melee action/attack. It can be used to "dodge" an attack by the user turning insubstantial before the attack strikes. This must be rolled as a normal dodge, but at +1.

The field is powered by a built-in battery that allows for up to one hour of uninterrupted intangibility or 20 "switch-ons" — whichever comes first. In other words, the character can only "phase out" and back 20 times before the power is exhausted or for a period of one hour, whichever comes first. Most users switch it on and off as needed to conserve energy.

The OP-field generator can be worn on a harness or built into armor. It has the same M.D.C. as other phase fields.

Market Cost: 60,000 credits for the standard harness and 90,000 credits to build into normal body armor. Batteries cost 5,000 credits. The batteries also have some components of the field generator built-in, so normal E-clips and conventional batteries will not work on this gadget.

Building it into a suit of powered armor is a lot more expensive: 600,000 credits plus the cost of the armor. Connect-

ing the field generator to a nuclear power plant does not give the field unlimited power, but raises the number of "switches" to 40 and the maximum time period to six hours per 24 hour period. Beyond 40 switches on and off, the OP-field generator becomes temporarily overloaded and must be allowed to "cool off" for 12 hours.

Phase-Tech Med Kit

Phase technology also has medical applications. A phase-tech kit has phase field generators and micro-beamers that can be used to perform surgery and antisepsis. Among other things, the med kit can remove bullets, shrapnel and other foreign objects embedded in a patient's body by turning them insubstantial; the inorganic objects drop right out and can be picked up and

thrown away! Cybernetic and bionic implants are not affected because they are attached to the neurological system of the character so they phase out too. Viruses can also be irradiated with phase beams calibrated to affect only them, killing them instantly without harming any beneficial micro-organisms. A full phase-tech med kit will give a basic Recovery Ratio (see Rifts, page 10) of 80% even if used under field conditions (i.e., not a proper medical facility) and 98% if used in a proper sick bay or hospital!

A "field" med kit costs 80,000 credits. It will give a Recovery Ratio of 55% in the field.

A full med-kit (including the equivalent of RMK and IRMSS med systems, drug dispenser with a full variety of medicines, and a phase-tech kit) costs 200,000 and weighs 30 pounds (13.6 kg). It will give a Recovery Ratio of 80% in the field.

Gravitonic Technology

The science of gravitonics is very important in the Three Galaxies. By controlling and manipulating the energies of gravity, scientists were able to defeat the light barrier, create artificial gravity on demand, and develop a number of weapons and vehicles that were unheard of before.

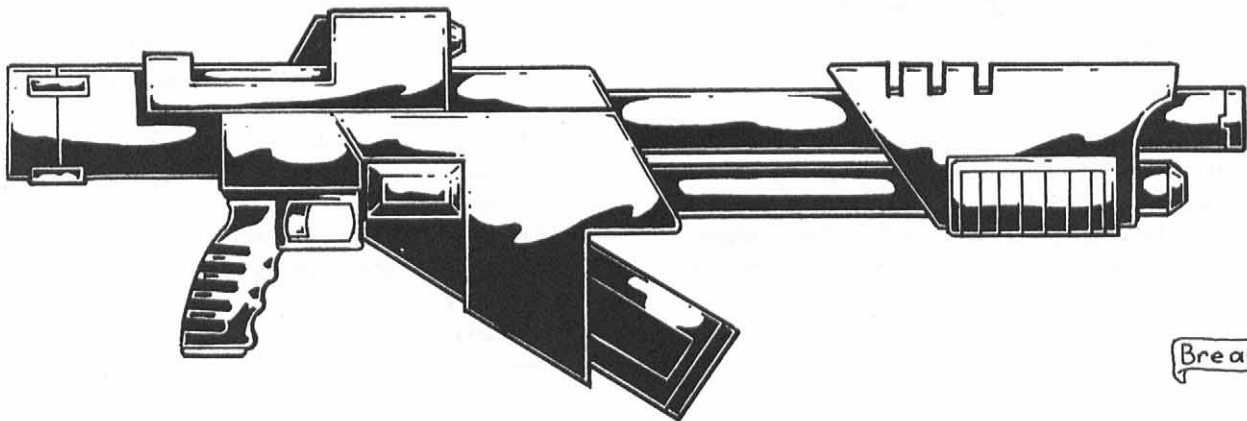

Gravity Rail Guns (GR-Guns)

These weapons are similar to normal rail guns, but they use gravitonic energy instead of electromagnetic power to propel their ammunition. A GR gun fires metal pellets at greater speeds than equivalent rail guns and do greater damage. GR guns can also be smaller, allowing for light rifle-sized weapons that can be carried by normal humanoids. On the other hand, gravity guns have a slightly shorter range; the slugs lose speed quicker than their electromagnetic counterparts. In space, however, double the effective range; in a zero-gravity environment, the slugs never lose their velocity, but long-distance accuracy still must be accounted for.

Many independent worlds supply their armies with gravity guns. Selected units in the Transgalactic Empire's armies are also issued these weapons, especially to deal with cosmo-knights who are effectively invulnerable to energy weapons.

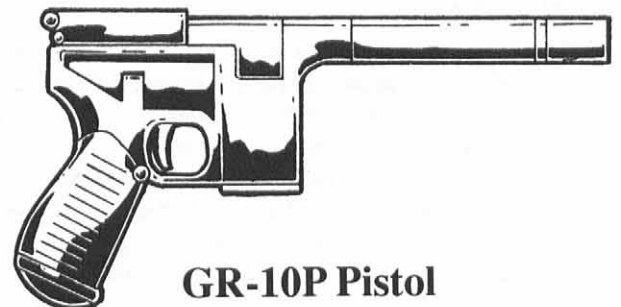

GR-10P Pistol

A long-barreled pistol somewhat similar to Earth's ancient Luger automatics. Each magazine has both the bullets and the micro-gravitonic generator to propel them.

Weight: 2 lbs (0.9 kg)

Mega-Damage: 2D4 M.D. per shot

Rate of Fire: Single shot only.

Effective Range: 800 feet (244 m)

Payload: 15 shots

Cost: 8,000 credits; magazines cost 500 credits

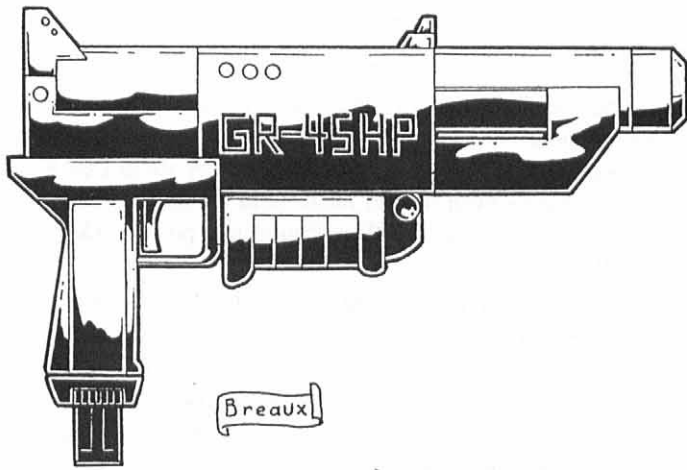

GR-45HP "Jackhammer"

Heavy Pistol

The "Jackhammer" resembles an Ingram or some other machine-pistol with a long barrel. It is heavier and harder to conceal, but has more penetration and stopping power. Used mostly by outlaws or mercenaries.

Weight: 6 lbs (2.7 kg)

Mega-Damage: A single round does 2D6 M.D. A three round burst does 5D6 M.D.

Rate of Fire: Single shots or three round bursts only.

Effective Range: 800 feet (244 m)

Payload: 27 shots

Cost: 15,000 credits. Each magazine costs 1,000 credits.

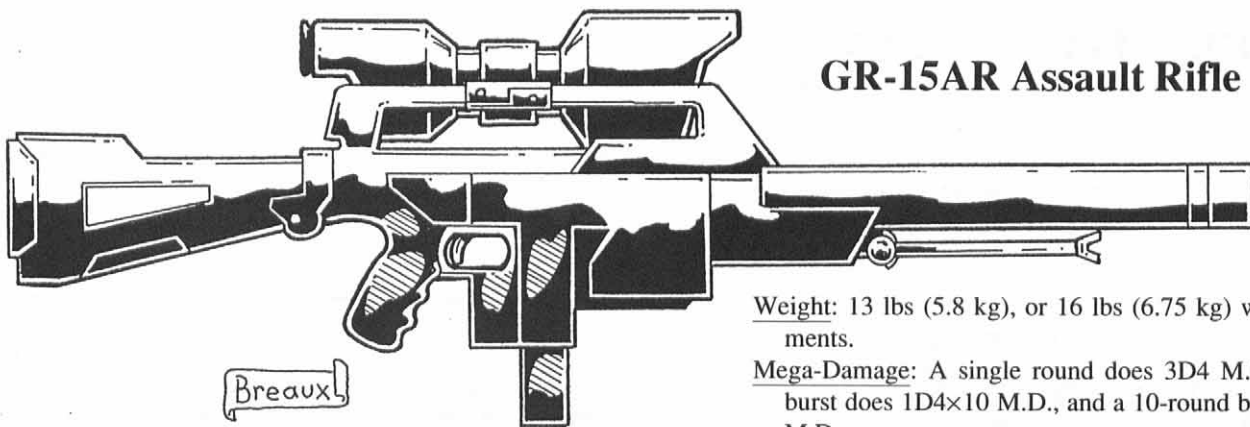

GR-15AR Assault Rifle

Weight: 13 lbs (5.8 kg), or 16 lbs (6.75 kg) with sniper attachments.

Mega-Damage: A single round does 3D4 M.D. A three round burst does 1D4×10 M.D., and a 10-round burst does 2D4×10 M.D.

Rate of Fire: Has a selector allowing single shots, 3-round bursts and 10-round bursts only. Each burst or shot counts as one melee attack.

Effective Range: 1,000 feet (305 m), or 2,000 feet (610 m) with sniper attachments (the scope also adds a +3 to strike)

Payload: 30 shots.

Cost: 22,000 credits. Each loaded magazine costs 2,000 credits.

The GR-15 is a heavy assault rifle with a carrying handle on the top, much like the M-16 used by 20th Century Earth soldiers. Like all GR guns, it has a long barrel to accelerate the slugs to ultrasonic speeds. The weapon can be reconfigured as a sniper rifle by attaching a multi-spectrum scope and a barrel extension (costs extra).

Grav Packs

This is a small contra-gravity device designed to allow the wearer to fly. The typical grav pack is strapped to the user's back and controlled through a wrist controller or neural connections (if neural connectors are used, the wearer is at +1 to dodge while flying). It will allow the wearer to fly at up of 200 mph (320 km) for 12 hours on a normal replaceable battery (an E-clip can be jury-rigged to replace the battery). In a vacuum, speed can be raised to an awesome Mach One (660 mph/1056 km)!

Grav packs can be very useful for imaginative operators. By trading speed for load capacity, a grav pack can be used to lift heavy weights. The maximum weight a grav pack can carry at full speed is 400 lbs (181 kg). Doubling the weight to 800 lbs (362 kg) reduces maximum speed to 50 mph (80 km). Up to one ton (907 kg) can be carried at 10 mph, and two tons (1,800 kg) can be moved or pushed as if they were near-weightless, but not inertialess — once you get the two tons (1,800 kg) moving it will take a great deal of force to make them stop!. **Note:** A normal human wearing the grav pack cannot carry super-heavy

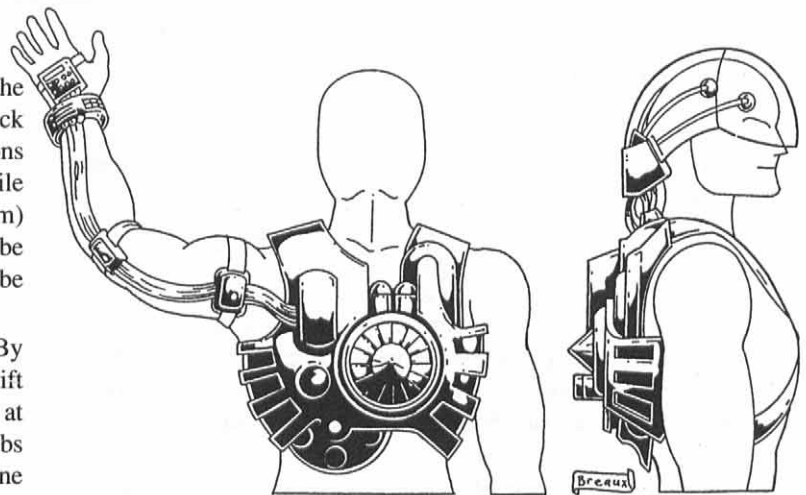

weights himself. Instead, a grav pack must be strapped to the object to be lifted. The user could climb on top of the object and use the controls to steer it. Using a grav pack in this way will drain the batteries twice as fast (6 hours of battery life).

Weight: 20 lbs (9 kg)

M.D.C.: 30

Market Cost: 150,000 credits. 550,000 for a nuclear powered grav pack with an average energy life of 10 years (allows for continual use of the generator).

Psionic Crystal Technology

The Noro race has developed a special form of technology based on a rare and valuable crystal known as *Psylite*. Psylite can be found in quartz formations, although only one-millionth part of most quartz contains psylite. Only a psychic sensitive can tell the difference between true psylite and worthless stones. These crystals can store I.S.P. energy even in their natural form. Mystics and psychics among the noro and other races have used it as a power focus for untold millennia. As the noro evolved and became a technological race, they studied and developed psylite as an energy source and the basis of a number of devices, tools and weapons.

All the weapons below use special crystal power packs that provide the I.S.P. required to power them. Crystal-cells cost 4,000 credits each and can be recharged by spending I.S.P. into them at the rate of 8 I.S.P. per charge (or only 4 at ley lines). These guns are called "crystal weapons" because they incorporate the psylite crystal into their power supply and firing mechanism, not because they are made out of crystal. However, many manufacturers tend to give the guns a crystalline or diamond shape, especially at the end of the barrel.

Mindwerks Note: The noro race never developed the science of *psynetics*, cybernetic enhancements that grant or augment psionic powers. Only the Angel of Death in her hidden Mindwerks base, has mastered this incredible technology. If word of it reached noro researchers (it hasn't so far), they might send a team of investigators (the player characters, perhaps?) to Rifts Earth to discover what this technology can achieve.

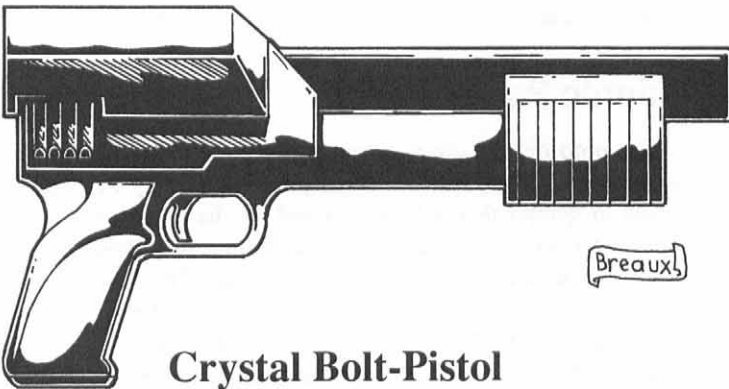

Crystal Bolt-Pistol

Only a psionic character (minor, major or master) can use this weapon, but it costs no I.S.P. to activate. The weapon is powered by a crystal battery that can be recharged by spending 100 I.S.P. It fires mega-damage mind bolts identical to the mind bolt super-psionic power, but does more damage! The damage of the gun is doubled at ley lines.

Weight: 3 pounds (1.4 kg).

Mega-Damage: 2D6 M.D. or 4D6 M.D. at ley lines.

Rate of Fire: Equal to the total number of hand to hand attacks per melee.

Effective Range: 1,000 feet (305 m).

Payload: 20 shots. A psionic character can power the gun himself, spending 5 I.S.P. per shot. 100 I.S.P. will reload the weapon.

Cost: 30,000 credits

Crystal Paralyzer

This handgun fires a psionic burst that temporarily scrambles the target's nerve impulses. The gun is meant to only neutralize voluntary nerve impulses, but there is a slight possibility that involuntary impulses (like the target's heartbeat or breathing) may also be disrupted! Still, this gun is less likely to kill the target than a regular M.D. weapon and is used by security forces, kid-nappers, slavers, etc., for non-lethal operations. This crystal gun can only be used by psionic characters, but it requires no I.S.P. to operate.

The paralyzer's blast is visible to the naked eye, and looks like a flash of purple light.

Weight: 3 lbs (1.4 kg).

Mega-Damage: None. A successful hit means the victim has to save vs psionic attack (add P.E. bonuses) by rolling 14 or higher. On a failed save, the character collapses for 1D4 melees. He is only vaguely aware of the things going on around him, like a person fading in and out of a deep sleep or anesthesia. If the save roll was a 5 or less (counting P.E. bonuses),

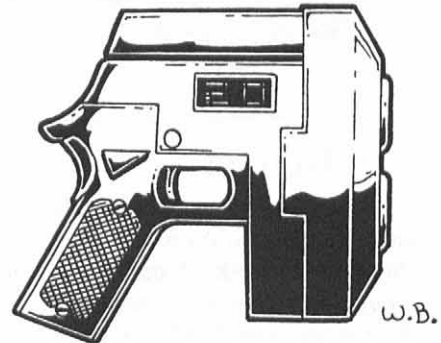

the character's heart has stopped! The victim has to roll against coma/death; the likelihood of recovery is based on the medical aid he may receive over the next 10 minutes.

Rate of Fire: Equal to the total number of hand to hand attacks per melee.

Effective Range: 500 feet (152 m).

Payload: Crystal magazine holds enough I.S.P. for 20 shots, or a psychic wielder can power the gun himself, spending 8 I.S.P. per shot. 160 I.S.P. will reload the weapon.

Cost: 35,000 credits

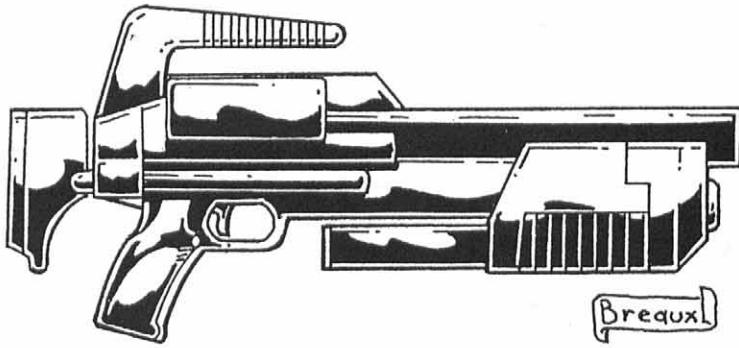

Crystal Assault Rifle

This weapon combines the effects of both the bolt pistol and the paralyzer gun, with greater damage and effectiveness. The user (who has to be a psionic) can mentally select the weapon's

setting, and can change it from one attack to the next. It is the standard issue weapon of the noro military and is often found in special units of the CAF.

Weight: 6 lbs (2.8 kg).

Mega-Damage: 4D6 M.D. for mind bolt or paralysis. Victims of paralysis must roll a 16 or higher to save (add P.E. bonuses) or are paralyzed as above. The risk of heart failure is the same as for the paralyzer gun.

Rate of Fire: Equal to the total number of hand to hand attacks per melee.

Effective Range: 2,000 feet (610 m) for both attack settings.

Payload: 40 shots from a Crystal-cell. The gun can be fired even if unloaded by spending 8 I.S.P. per shot, or the gun can be reloaded at the same rate (8 I.S.P. per shot or 320 to completely reload).

Cost: 55,000 credits.

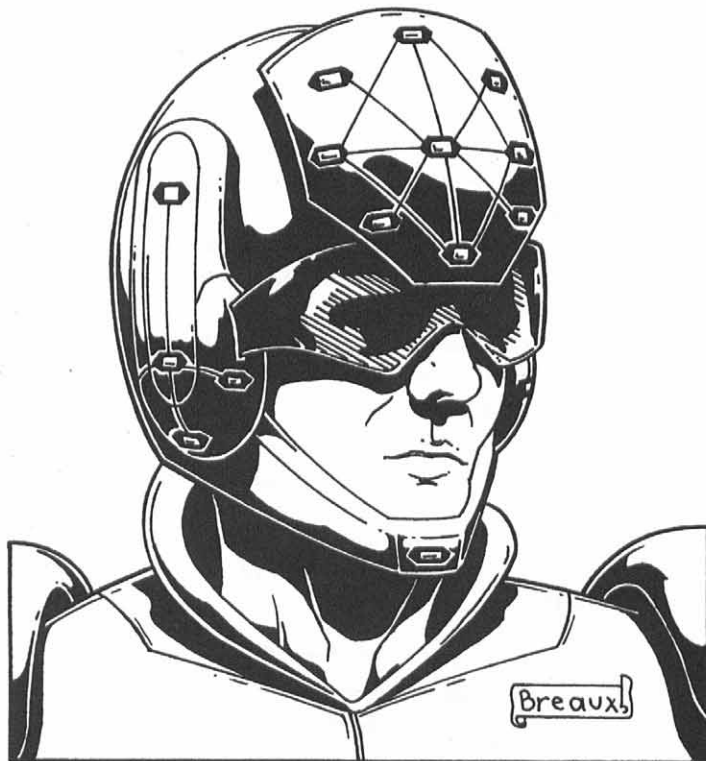

Augmenting Helmet

This helmet focuses a psychic character's I.S.P. energy, allowing him to enhance his powers. As long as the character wears the helmet, with its latticework of perfectly aligned crystals, every one I.S.P. point he spends will count as two! In effect, the character's I.S.P. capacity is doubled! Example: A psionic using a group mind block costing 22 I.S.P. need only spend 11 to activate it. Typical helmets are built inside layers of M.D.C. armor, which can replace normal environmental armor helmets (helmet M.D.C. is 30).

Market Cost: 50,000 credits.

Telepathic Communicator

This device can be worn as either a wristband or a headband. Its crystals greatly amplify telepathic powers, allowing any character with any type of telepathy to reach another telepath at

ranges of up to 10 miles (16 km). If two telepaths are both using the communicators, the maximum range becomes 20 miles (32 km). I.S.P.: 10, Cost: 52,000 credits.

Psionic Crystal Armor

This is a suit of normal light body armor (M.D.C. 35) that has an embedded psylite lattice that projects a psionic force field with 70 M.D.C. When the force field drops to zero, it can be automatically activated four times per every 24 hour period, or the wearer (who has to be a psionic) can activate the field himself by spending 20 I.S.P. of his own. The same amount of energy will also recharge the crystal array.

M.D.C.: 35 for the armor itself and 70 M.D.C. from the psionic force field (the field can be turned on 4 times per 24 hour period without I.S.P. cost to the user).

Bonuses: While the force field is up, the target also receives a +2 bonus to save vs psionic attack!

Weight: The armor itself is light, 10 lbs/4.5 kg, and has no prowl penalty.

Cost: 100,000 credits.

Psionic Power Armor

The noro did not enjoy developing weapon systems, but encounters with many warrior races proved that they needed the means to defend themselves. Inspired by the power armor designs their enemies used, noro psi-technicians developed a power armor suit based on crystal technology. This was the only exoskeleton used by the noro Federation armed forces prior to their joining the CCW, and it was able to hold its own against all comers. This suit continues to be in use in the CAF and it has been adapted to fit any humanoid psychic wearers.

Non-psionics cannot activate the armor's powers, but anybody with even the smallest amount of psionic ability can operate it as if it was an extension of his own body. Only the most sophisticated mechanical systems can match the fluidity and speed of these psionic suits. Additionally, the suits have specially encrypted crystals that activate a number of psionic powers, ranging from force fields and energy bolts to telepathic powers that can confuse or panic enemy soldiers.

The original “V” armor was not designed to fight in outer space. Inside spaceships, it is used as an interior defense force against intruders who breach the hull of the vessel — this has led to some military disasters due to that limitation. As a result, the NF Model “X” was designed. It used a contra-grav pack that gave it fair flying and maneuvering capabilities both in an atmosphere and outer space, but they were inferior to other CAF battlesuits and the Model X is no longer in military service. However, it can still be found among planetary military forces, pirates and mercenaries.

Both types of psionic armor have a slender profile, not unlike that of their noro creators, except for the upper torso and head. The upper torso has two thick plates that protect two missile launchers. The head has cheek guards and extra layers of ornamental armor that give it more protection than normal. The extra armor is necessary because if the helmet goes, the armor will lose power and will be worse than useless, trapping the wearer in almost two hundred pounds (91 kg) of unyielding metal (a super-strong wearer might be able to continue moving or fighting, but at a severe handicap). Some of the noro’s warrior instincts

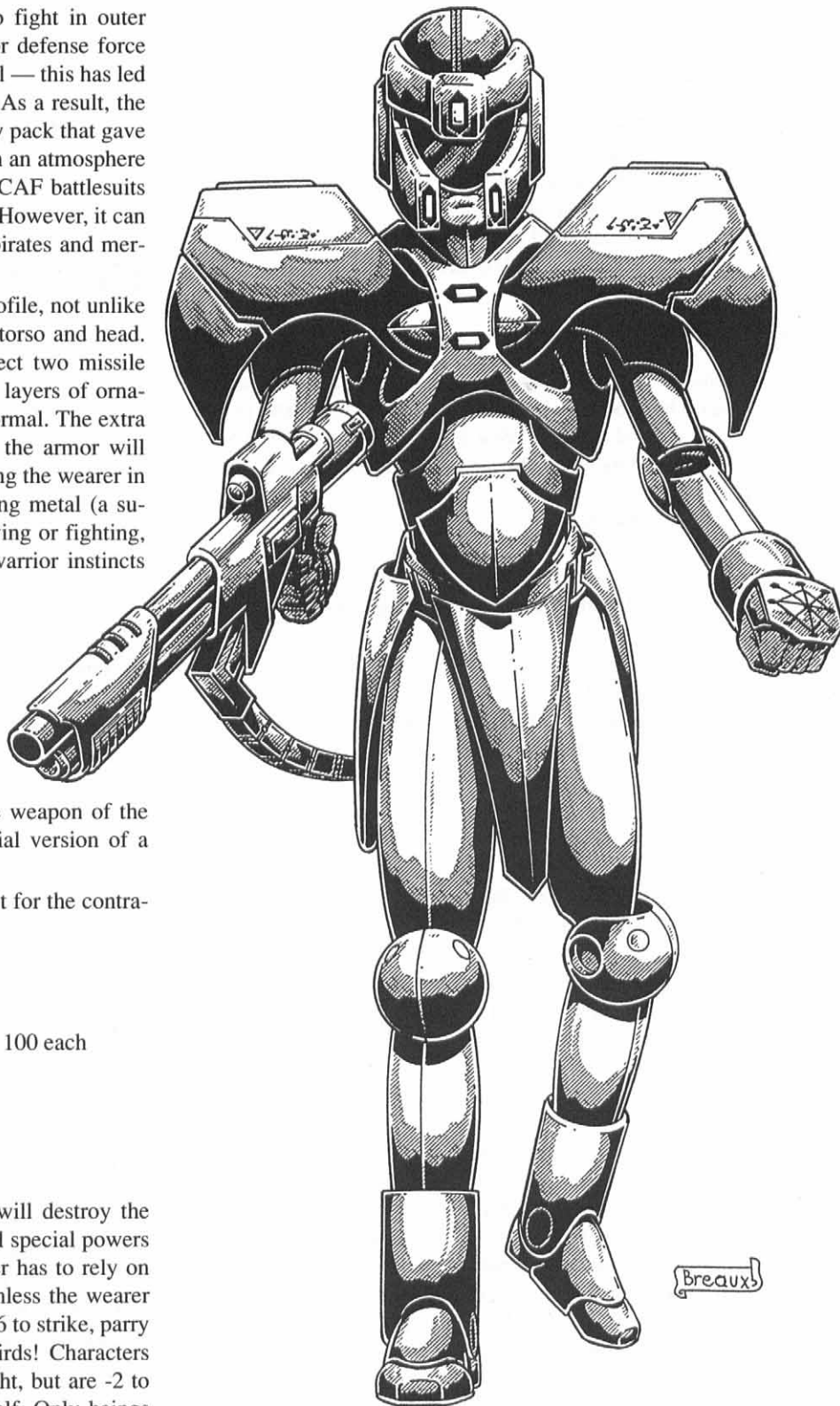

must have survived, because the most fearsome weapon of the armor is a two-handed energy blade, an artificial version of a psi-sword.

Model Type: NF Model V or X (identical except for the contra-gravity flight system).

Class: Psionic Assault Exoskeleton

Crew: One

M.D.C. by Location:

Shoulder Plates/Mini-missile launchers (2) — 100 each

Arms (2) — 60 each

Legs (2) — 80 each

* Head — 100

** Main Body — 210

Psionic Force Field — 200

* Destroying the head of the power armor will destroy the crystalline network that powers the armor. All special powers and bonuses are lost. Furthermore, the wearer has to rely on his own muscle power to carry the armor; unless the wearer has a P.S. of 24 or higher, the character is at -6 to strike, parry and dodge, and Speed is reduced by two-thirds! Characters with a P.S. of 24 or higher can move and fight, but are -2 to parry and dodge, and speed is reduced by half. Only beings with a supernatural P.S. of 25 or higher can wear the armor and move without penalties. Getting out of the armor after the helmet is destroyed takes 2D4 minutes.

** Depleting the M.D.C. of the main body will shut the armor down completely, making it useless.

Speed:

Running: 100 mph (160 km) maximum; the act of running does tire out the operator, but only at 10% the normal fatigue rate.

Flying: Model V: only through the use of jet packs. Model X: Contra-gravity system allows wearer to fly at 200 mph (320 km) in an atmosphere and up to Mach One (670 mph/1080 kmph) in a vacuum.

Range: Mark X only: Effectively unlimited.

Statistical Data:

Height: 9 feet (2.7 m)

Width: 5 feet (1.5 m)

Length: 4 feet (1.2 m)

Weight: Mark V: 200 lbs (91 kg); Mark X (includes contra-gravity and nuclear power system): 400 lbs (181 kg).

Physical Strength: Equal to a P.S. of 40

Cargo: None

Power System: Mark V: Psionic Crystals; 2,000 I.S.P., uses 1 I.S.P. per hour of operation which may be provided either by the operator or the crystal power system. Mark X: As above, plus a small nuclear system for the contragravity system only. Energy life of the suit is 20 years.

Market Cost: Mark V: Four million credits. Mark X: Eight million credits.

Weapon Systems

1. Mind Bolts: The power armor can shoot mind bolts through its hands. These bolts do more damage and have greater range than normal mind bolts and cost less I.S.P. to use. This I.S.P. can be provided by either the wearer or the suit's crystal batteries.

Primary Purpose: Assault

Secondary Purpose: Defense

Mega-Damage: 4D6 M.D. per blast

Rate of Fire: Equal to the total number of hand to hand attacks per melee.

Effective Range: 2000 feet (610 m)

Payload: Each bolt costs 2 I.S.P.

2. Mini-missile Launchers (2): The shoulder plates hide two missile launchers, one of the two weapon systems that do not use I.S.P. power.

Primary Purpose: Anti-armor

Secondary Purpose: Defense

Mega-Damage: Varies with missile type.

Rate of Fire: One at a time or volleys of two, four or eight.

Effective Range: About one mile.

Payload: 16, 8 in each shoulder.

3. GR-Rifle: A gravity-powered rail gun used as the armor's main weapon. It carries its own power system and ammo.

Primary Purpose: Anti-armor and anti-infantry.

Secondary Purpose: Defense

Mega-Damage: A burst is 20 rounds and does 1D6 × 10 M.D. A single round does 2D6 M.D.

Rate of Fire: Equal to the number of hand to hand attacks.

Effective Range: 4000 feet (1200 m)

Payload: 2,000 round drum magazine (that's 100 bursts).

4. Fear Beam: The helmet unit can use a special form of the empathic transmission super-psionic power. This attack looks like a wave of light coming out of the helmet. The target must save vs psionics or be struck by unreasoning terror. The target is at -3 to strike, parry and dodge, plus there is a 50% chance that those affected will turn and run. The beam can affect one target at a time, and the effect will last 1D4 minutes.

5. Special Features: The suit has the standard sensors found in most powered armor (see **Rifts**, page 211), plus a number of unique psionic features. The I.S.P. to activate these powers can come from the wearer or the suit itself.

See the **Invisible:** Equal to the psionic power, but only costs 2 I.S.P. to activate.

Telepathic Communication: Costs 4 I.S.P. per hour and range is 10 miles (16 km)! Allows for telepathic conversations (like a radio) between two psionic characters (will not work for non-psionics).

Presence Sense: Equal to the psionic power, but only costs 2 I.S.P. to activate.

6. Hand to Hand Combat: Rather than use a weapon, the pilot can engage in mega-damage hand to hand combat. See **Power Armor Combat Training**. Likewise, the character can use conventional energy rifles or rail guns as additional handheld weapons.

Robots & Powered Armor

Although giant robots and power armor are not quite as common as they are on Rifts Earth, they play an important part in military operations of the Three Galaxies. The CAF has two standard types of power armor and two classes of combat robots for "groundside" action and another two for space combat (the latter can also perform in an atmosphere). The Transgalactic Empire has its share of large robots and robotic vehicles, but only one class of light power armor. Naruni Enterprises has a whole line of different styles of combat armor and robot vehicles. Besides the ones listed here, all the robots, battlesuits and combat drones described in **Rifts Mercenaries** are available throughout the Three Galaxies. They also occasionally acquire (trade, steal or purchase) bots and power armor from *other* manufacturers for resale. These can include Kreeghor, Kittani, Northern Gun, Glitter Boys and even CS and Triax items. The United Worlds of Warlock actually mass produces suits of Mystic Power Armor (see **Rifts**, page 96), which they sell for a mere 500,000 credits.

The list below is only a sampling of available robot, power armor and vehicles. More weapons, vehicles and information on the technologies available in the Phase World universe will be available in the **Phase World Sourcebook One: The Three Galaxies**.

Silverhawk

Attack ExoSkeleton (CAF)

The Silverhawk is a compromise between the desire for firepower and heavy armor and the need for speed and maneuverability. This power armor suit has been in service with the Consortium Armed Forces for over a century and remains a tried-and-true, highly regarded model. Only the best combat pilots of the Consortium are assigned to Silverhawk units.

The armor has a sleek, streamlined design. Although its contragravity propulsion system makes wings unnecessary, the suit has a set of aerodynamic wings used as a weapons platform more than anything else. The armor's normal color is highly polished silver, but it has a stealth system that allows it to assume the color of the surrounding terrain (or starry sky, in the case of space combat).

Standard CAF strategy calls for combined fighter and powered armor assaults on large enemy vessels, staged while larger ships provide support and protection. The Silverhawk, while not as fast as a space fighter, has enough firepower and muscle to break through the hull of a starship and wreak havoc inside. A special feature of this armor is a special space-time distorter that



allows it to penetrate standard ship force fields. Added to the armor's contragravity flying system, this makes the Silverhawk a nightmare for the commanders of large vessels. In an atmosphere, the Silverhawk's speed and maneuverability are unmatched by most robot designs.

Rifts Note: The contragravity system of this robot is centuries ahead of anything produced on Rifts Earth. While this suit will fly rings around anything produced there, if the flying system is damaged or destroyed, it cannot be repaired unless it is brought back to Phase World or some other technical facility in the Three Galaxies.

Model Type: SH-CCW100

Class: Space-capable assault exoskeleton

Crew: One

M.D.C. by Location:

Shoulder Plates (2) — 100 each

Wings/Missile Launchers (2) — 100 each

Multi-Rifle — 150

Arms (2) — 120 each

Legs (2) — 150 each

* Head — 100

** Main Body — 420

*** Contragravity System (1, in back) — 200

* Destroying the head of the power armor will eliminate all forms of optical enhancement and sensory systems. The pilot is forced to rely on his own human vision and sensors. Furthermore, all power armor combat bonuses to strike, parry and dodge are lost. More importantly, in the vacuum of space the character will be subject to explosive decompression, dehydration, freezing and asphyxiation. Most alien species will suffer 1D4×10 S.D.C. damage immediately and will die in 1D4 minutes. **Note:** The head can only be hit when a character makes a called shot and even then the attacker is at -4 to strike.

** Depleting the M.D.C. of the main body will shut the armor down completely, making it useless. **Note:** Destroying the wings does NOT affect the flying performance of the Silverhawk.

*** Destroying the contragravity system reduces all the special bonuses given below and prevents the armor from flying. A normal jet propulsion system or jet backpack can replace the contragravity system, but it won't have any of the special flight bonuses and its speed will be a fraction of normal (that of the replacement system).

Speed:

Running: 70 mph (112.6 km) maximum. Note that the act of running does tire out its operator, but at 5% of the usual fatigue rate, thanks to the robot exoskeleton and contragravity system (if the contragravity system is destroyed, fatigue rate becomes 10% of normal).

Flying: Up to Mach 2 (approximately 1340 mph/2144 km) in an atmosphere or an amazing Mach 12 in space!

Altitude: Unlimited. The contragravity system allows the suit to escape a planet's atmosphere and fly out of orbit.

Underwater: Maximum speed of 50 mph (80 km) to a maximum depth of 1000 feet (310 m).

Range: Unlimited. The contragravity system does not overheat. The only limit is the pilot's endurance.

Statistical Data:

Height: 9 feet (2.7 m)

Width: 11 feet (3.4 m) including the wings, 5 feet (1.5 m) otherwise

Length: 4 feet (1.2 m)

Weight: 1000 lbs (450 kg)

Physical Strength: Equal to a P.S. 50

Cargo: None

Power System: Nuclear; average energy life of 20 years.

Market Cost: 3.4 million credits. Cheaper knock-offs can be found in disreputable ports (and Phase World). They cost one to 1.5 million credits, but have 30% less M.D.C. and lack the force field disrupter and the stealth system.

Weapon Systems

1. Multi-Rifle: This is a large, three-barreled weapon designed to fire a variety of ordnance. One barrel is a heavy HI-laser cannon. The thicker top barrel is a short-range particle beam generator with devastating damage, and the stubbier barrel fires gravitonically-propelled grenades. Infantry soldiers have been known to run or surrender when faced with this intimidating three-barrel gun.

Primary Purpose: Anti-armor and anti-ship.

Secondary Purpose: Anti-personnel

Mega-Damage: HI-Laser: 2D4×10 M.D., particle beam cannon: 3D6×10 M.D., grenades: varies with grenade type. At short range, both the laser and the particle beam cannon can attack at the same time, doing a combined damage of 4D6×10+20 M.D.!!

Rate of Fire: Equal to the total number of hand to hand attacks.

Effective Range: Laser: 10,000 feet (3,050 m). Particle Beam Cannon: 2,000 feet (610 m). Grenade Launcher: 1,000 feet (305 m), All are doubled in space.

Payload: Effectively unlimited for the laser and particle beam weapon; 200 grenades for the launcher.

2. Wing Mini-Missiles: Each wing has 8 mini-missiles. In space combat, they are used at relatively short ranges (1000 feet/305 m or less), otherwise, some of the faster fighters and spaceships can actually outrun the missiles!

Primary Purpose: Anti-ship

Secondary Purpose: Defense

Mega-Damage: Varies with missile type. Usually they are armor-piercing (1D4×10 M.D.) or plasma (1D6×10 M.D.).

Rate of Fire: One at a time or in volleys of 2, 4, 8, or 16.

Effective Range: About one mile (1.6 km). In space, effective range is limited by the speed and distance of the target.

Payload: 16 total, 8 on each wing.

3. Six-Shooters (2): A gravity gun is mounted on each wrist of the armor. They are used for short range anti-personnel attacks, or as a back-up weapon.

Primary Purpose: Anti-personnel.

Mega-Damage: A burst of three rounds does 5D6 M.D. Can only fire bursts.

Rate of Fire: Equal to the total number of hand to hand attacks.

Effective Range: 800 feet (244 m), doubled in space.

Payload: 240 rounds each; that's 80 bursts each.

4. Force Field Disrupter: The armor is equipped with a special energy field designed to penetrate the force fields used by many spaceships. The disrupter causes the whole armor to "pulse" energy in wavelengths that cancel out the force field and enables the silverhawk to walk right through the protec-

tive field. The power armor has to fly very close to the ship to do this (force fields usually extend about 10 to 20 feet (3 to 6 m) from the hull).

Primary Purpose: Defense penetration

Mega-Damage: None. Creates a momentary hole that the character can step through. No effect on solid objects or living things.

Rate of Fire: One pulse per melee round; effect/hole lasts 3 seconds.

Effective Range: The disrupter field has a range of 20 feet (6.1 m).

Payload: Effectively unlimited.

5. Stealth Systems: The Silverhawk can change colors to match the background and can mask all heat emissions, becoming effectively invisible. The stealth systems are only effective if the Silverhawk is flying in a straight line or standing still. Evasive maneuvers or attacks will reveal the armor's position, although it will still be hard to see and hit (all attackers are at -1 to strike).

6. Hand to Hand Combat: Rather than use a weapon, the pilot can engage in mega-damage hand to hand combat.

Bonuses and Damage from Silverhawk Combat Training:

Restrained Punch — 1D6 M.D.

Full Strength Punch — 3D6 M.D.

Power Punch — 6D6 M.D. (counts as two attacks)

Kick — 4D6 M.D.

Leap Kick — 6D6 +3 (counts as two attacks)

Body Block/Ram (on the ground) — 2D6 M.D.

Body Block/Ram (flying) — 4D6 M.D.

+2 to strike

+4 to parry

+4 to dodge on the ground

+6 to dodge flying

+3 to roll with impact

+2 to pull punch

+2 melee actions/attacks at level one.

+1 additional attack at levels four, eight, and twelve.

Note: If gravity flying system is destroyed or disable, reduce the bonuses to parry, dodge and roll with impact by half.

Battleram Attack Robot (CAF)

The Battleram is a ship destroyer, pure and simple. It is the largest robot in CAF service and one of the largest robots found in the Three Galaxies. It is designed to be launched from a carrier-ship, travel at great speeds towards enemy vessels while firing at them, and then smash through their hull and literally tear the ship apart. The robot can also carry a ten-man squad that can be released into enemy ships to capture or destroy them. Although huge by robot standards, the Battleram is still a small target for heavy ship weapons (see *Ship to Ship Combat*), so it must be engaged by smaller anti-aircraft batteries or escorting fighters and robots.

When flying, the robot's arms are extended forward/upward, like the classic superhero conception of flying humanoids, and locked into place. The pilot and co-pilot treat it like a fighter, using its weapon systems to neutralize enemy escorts. Usually, a Battleram is escorted by several fighters or smaller robots like the Silverhawk, so it can reach its target relatively unharmed.

Still, there are drawbacks to the robot's size. It can only dodge attacks while flying and it remains a big, easy-to-hit target for fighters and robots, and even some ship weapon systems.

Model Type: BR-CCW2000

Class: Anti-Ship Assault Robot

Crew: Two. One pilot and a co-pilot/gunner. A communications/sensor officer is optional. The robot can contain as many as twelve human passengers comfortably. Usually carries a ten-man combat squad equipped with heavy combat armor, grav packs and full combat gear, or a four-man power armor assault force in Silverhawks or Ground Pounders.

M.D.C. by Location:

Gravity Cannon (handheld) — 300

HI-Laser Cannon (shoulder) — 250

Pop-Up Cruise Missile Launcher — 200

Long-range Missile Launchers (2, chest) — 200 each

Medium-range Missile Launchers (2, legs) — 100 each

Mini-Missile Launcher (Left Arm) — 100

Laser Eyes (2) — 70 each

Lower Arms (2) — 240 each

Upper Arms (2) — 240 each

Shoulders (2) — 400 each

Hands (2) — 160 each

Legs (2) — 600 each

Feet (2) — 300 each

Main Hatch (1, on the back) — 150

Emergency Escape Hatches (2) — 60 each

* Head and Sensors — 400

** Main Body — 2,500

Reinforced Pilot's Compartment (chest) — 170

*** Force Field — 500

* Destroying the sensor head of the bot will eliminate all forms of optical enhancement and sensory systems. The pilot must then rely on his own human vision and senses without bonuses to strike, parry, and dodge from the bot.

** Depleting the M.D.C. of the main body will shut the armor down completely, making it useless.

*** The M.D.C. of the force field must be depleted before any part of the robot can be targeted and attacked.

Speed:

Running: 40 mph (64 km) maximum.

Flying: In outer space, it can reach Mach 8. In an atmosphere, maximum flying speed is Mach 1.

Range: Effectively unlimited.

Statistical Data:

Height: 70 feet (21.3 m) from the bottom of its feet to the top of its sensor head.

Width: 40 feet (12.2 m) from shoulder to shoulder

Length: 30 feet (9.1 m)

Weight: 220 tons (200 metric tons) fully loaded

Physical Strength: Equal to a P.S. 70

Cargo: Lockers for the crew, an armory, and an 8×8×8 foot (2.4×2.4×2.4 m.) storage bay.

Power System: Antimatter, average energy life is 30 years

Market Cost: 200 million credits. The CAF never sells this vehicle; models found in the possession of others are stolen or captured.

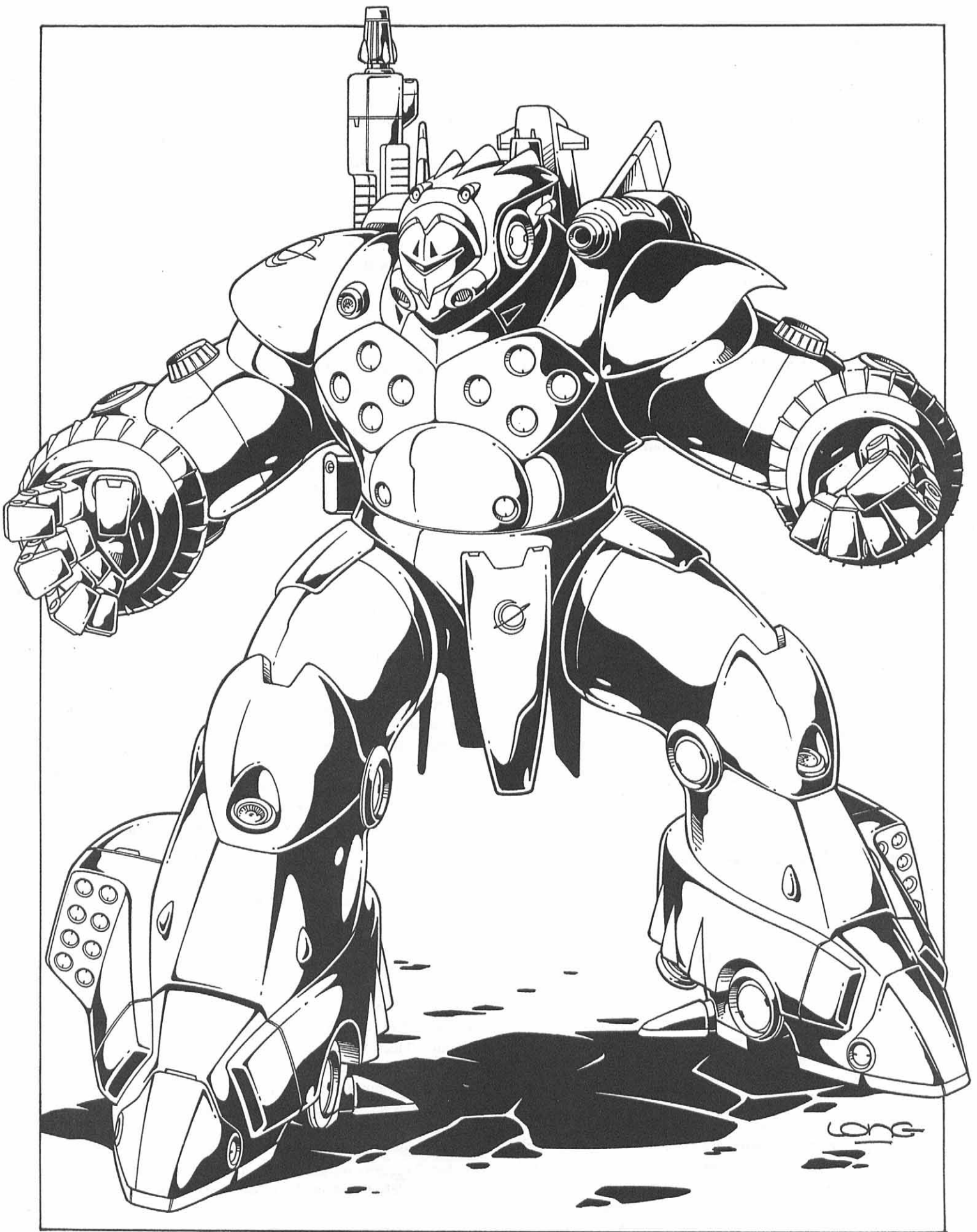

Weapon Systems

1. Gravity Cannon: This 5 ton (4,500 kg), rifle-shaped weapon is a GR autocannon. The rifle can be attached to back clamps when not in use.

Primary Purpose: Anti-armor and anti-ship

Secondary Purpose: Anti-aircraft

Mega-Damage: A burst is 20 rounds and does 4D6×10 M.D.

Can only fire bursts.

Rate of Fire: Equal to the total number of hand to hand attacks.

Effective Range: 6 miles (25 km) in space. About five miles (8 km) in an atmosphere.

Payload: 10,000 rounds; that's 500 bursts!

2. HI-Laser Cannon: A cannon mounted over the left shoulder. Can rotate 190 degrees up and 180 degrees to the left, but cannot engage small targets closer than 20 yards away.

Primary Purpose: Anti-armor & anti-ship

Secondary Purpose: Anti-aircraft

Mega-Damage: 3D6×10 M.D.

Rate of Fire: Equal to the total number of hand to hand attacks.

Effective Range: 8 miles (12.8 km) in space, 2 miles (3.2 km) in an atmosphere.

Payload: Effectively unlimited.

3. Pop-Up Cruise Missile Launcher: On the back of the robot is a cruise missile in a pop-up launcher. This weapon is used at point-blank range (less than one mile away) from the target, usually a large ship or a space station.

Primary Purpose: Anti-ship

Secondary Purpose: Anti-building

Mega-Damage: 2D6×100 M.D. or 4D6×100 M.D.

Rate of Fire: One.

Effective Range: 10 miles (16 km).

Payload: One missile.

4. Long-Range Missile Launchers (2): The Battleram's chest has two long-range missile launchers with four missiles in each. This weapon is commonly used against fighters and other robots.

Primary Purpose: Anti-robot and anti-aircraft

Secondary Purpose: Defense

Mega-Damage: Varies with missile type.

Rate of Fire: One at a time or volleys of two or four.

Effective Range: 500 miles (800 km).

Payload: 8, four in each launcher.

5. Medium-Range Missile Launchers (2): Each of the robot's legs holds a medium-range missile launcher, also used against fighters and enemy robots.

Primary Purpose: Anti-fighter and anti-robot

Secondary Purpose: Defense

Mega-Damage: Varies with missile type.

Rate of Fire: One at a time or in volleys of two, four or eight.

Effective Range: About 50 miles (80 km).

Payload: 16, eight in each launcher.

6. Mini-Missile Launcher (Left Arm): The left arm contains a mini-missile launcher that can be used against infantrymen or as an anti-missile defense system.

Primary Purpose: Anti-personnel

Secondary Purpose: Defense

Mega-Damage: Varies with missile type.

Rate of Fire: One at a time or in volleys of two, four, eight or sixteen.

Effective Range: About one mile (1.6 km).

Payload: 16 missiles.

7. Hand to Hand Combat: Rather than use a weapon, the pilot can engage in mega-damage hand to hand combat.

Bonuses and Damage from Battleram Combat Training:

Restrained Punch — 4D6 M.D.

Full Strength Punch — 2D6×10 M.D.

Power Punch — 4D6×10 M.D. (counts as two attacks)

Crush, Pry or Tear — 2D6×10 M.D.

Kick — 3D4×10 M.D.

Leap Kick (only while flying) — 4D6×10 M.D.

Body Flip/Throw — 4D6 M.D.

Body Block/Ram (on the ground) — 2D4×10 M.D.

Flying Ram — 5D6×10 M.D.

Stomp — 6D6 M.D. against targets 15 feet (4.5 m) tall or smaller.

+1 to strike (in addition to weapons bonuses)

+1 to parry

No dodge on the ground

+1 to dodge while flying

No roll with impact

+1 additional melee actions/attack at levels 2, 6, 10, and 14,

Note: Reduce combat bonuses by half if there is no co-pilot to serve as the gunner. Also reduce the number of attacks per melee by two.

“Ground Pounder” PA-10 Infantry Power Armor (CAF)

CAF ground-assault units are supported by non-flying power armor suits. The PA-10 “Ground Pounder” is one of the most common models and fairly popular among the troops. Big and solid-looking, the ground pounder is designed to soak up a lot of punishment while dishing out as much or more damage right back. Outfitted with an array of missiles, mortar rounds and laser beams, it can be used both for frontal assault and to provide artillery support.

Some PA-10 suits are being sold on the black markets of the CCW and openly at places like Phase World. Nobody knows who supplies them — but the existence of black market Ground Pounders might explain why the rebels of the Free World Council have been buying them and using them against the Empire. Or maybe not.

Model Type: CAF-PA-10

Class: Ground Infantry Assault Exo-Skeleton

Crew: One

M.D.C. by Location:

Shoulder Missile Launchers (2) — 40 each

Automatic Mortars (2) — 50 each

Particle Beam Cannon (right arm) — 80

Chest Laser — 60

Arms (2) — 180 each

Legs (2) — 200 each

* Head — 100

** Main Body — 450

* Destroying the head of the power armor will eliminate all forms of optical enhancements and sensory systems. The pilot is forced to rely on his own human vision and senses. Furthermore, all power armor combat bonuses to strike, parry

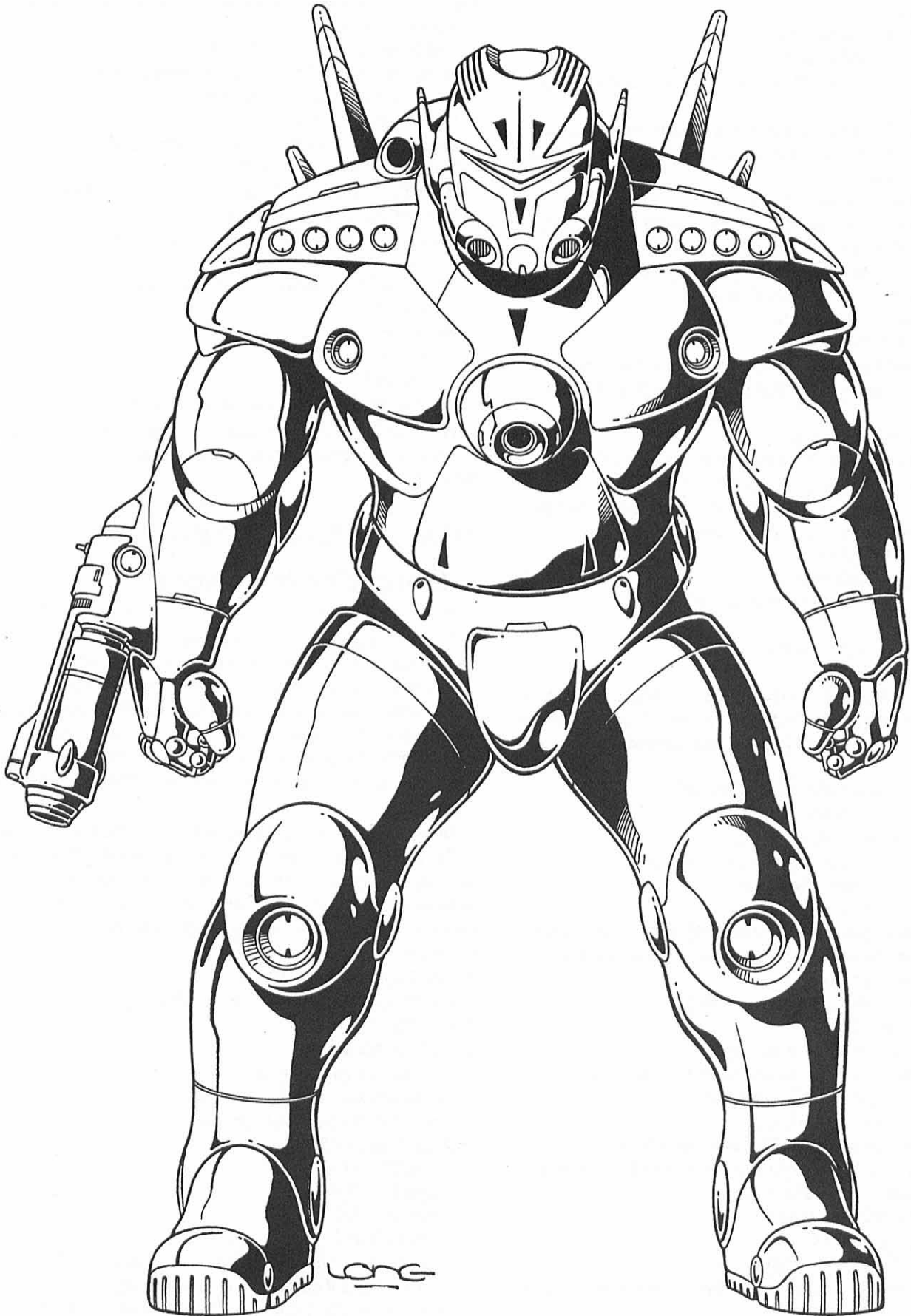

and dodge are lost! The head is a small target that can only be hit when a character makes a called shot, and even then the attacker is -4 to strike.

** Destroying the M.D.C. of the main body will shut the armor down completely, making it useless.

Speed:

Running: 100 mph (160 km) maximum. Note that the act of running does tire out its operator, but at 10% of the usual fatigue rate, thanks to the robot exoskeleton.

Jumping: The powerful robot legs can leap up to 15 feet (4.6 m) high or across.

Flying: Not possible.

Statistical Data:

Height: 9 feet (2.7 m) from head to toe

Width: 6 feet (1.8 m)

Length: 4 feet (1.2 m)

Weight: 1 ton (907 kg)

Physical Strength: Equal to a P.S. of 45

Cargo: None

Power System: Anti-matter, average energy life is 50 years.

Market Cost: 4 million credits

Weapon Systems

1. Particle Beam Cannon: The main weapon system of the ground pounder is a powerful energy cannon mounted on the right arm.

Primary Purpose: Anti-armor

Secondary Purpose: Anti-personnel

Mega-Damage: 2D4×10 M.D. per blast

Rate of Fire: Equal to number of combined hand to hand attacks per melee round.

Effective Range: 4000 feet (1200 m)

Payload: Effectively unlimited.

2. Missile Launchers (2): Each shoulder holds a mini-missile launcher with four missiles each.

Primary Purpose: Anti-aircraft and anti-personnel

Secondary Purpose: Defense

Mega-Damage: Varies with missile type.

Rate of Fire: One at a time or in volleys of two or four.

Effective Range: About one mile (1.6 km).

Payload: 8 total, four per launcher.

3. Automatic Mortars (2): These back-mounted mortars are used to attack defensive positions while staying behind cover.

The mortar rounds (fragmentary explosives) are in a magazine on the back; the Ground Pounder carries no reloads, but can get them from supply trucks that usually follow the infantry.

Primary Purpose: Anti-personnel

Secondary Purpose: Anti-vehicle

Mega-Damage: 4D6 M.D. to a 30 foot (9.1 m) radius

Rate of Fire: Equal to number of combined hand to hand attacks per melee round.

Effective Range: 4000 feet (1200 m); can fire above fortifications and obstacles.

Payload: 60 round magazine per launcher.

4. Chest Laser: A laser beamer is mounted on the chest and is used for close-range combat.

Primary Purpose: Anti-personnel

Secondary Purpose: Defense

Mega-Damage: 4D6 M.D. per blast

Rate of Fire: Equal to the total number of combined hand to hand attacks per melee round.

Effective Range: 2000 feet (610 m)

Payload: Effectively unlimited

5. Hand to Hand Combat: Rather than use a weapon, the pilot can engage in mega-damage hand to hand combat. See Basic and Elite Power Armor Combat Training in the Robot Combat section of **Rifts**, page 45. All abilities are the same except as follows:

Normal Punch — 2D4 M.D.

Power Punch — 3D6 M.D.

Warlord Mark I

Combat Suit (Transgalactic Empire)

The Warlord Mark I is a power armor suit designed around the kreeghor race's unique anatomy (see the *Kreeghor R.C.C.*). As a result, the armor has the same sinuous, crouched posture of the race. Also like the kreeghor themselves, this battlesuit is brutal, blindingly fast, and lethal. Elite kreeghor armored units are equipped with the Warlord suit exclusively. These suits are not designed to fly — for some reason the kreeghor do not feel comfortable flying in anything other than space fighters or "true" aircraft and leave such antics to their humanoid underlings (see the *Warlord Mark II*, which follows). Instead, kreeghor troopers are used in space combat as a defense force inside ships and space stations, but primarily as "groundsider" infantry troops, where their speed and strength are much more effective.

The Warlord Mark I has a great deal of firepower, including a gravity autocannon and a particle beam gun, a missile launcher and a double-barreled helmet laser. For close combat, the Mark I can extend two adamantine forearm blades, sharpened to a molecular edge. They are used for slashes and stabbing that can slice open the toughest M.D.C. armor.

Model Type: IPA-WI-K

Class: Assault Exoskeleton

Crew: One

M.D.C. by Location:

Gravity Autocannon (left arm) — 200

Particle Beam Gun (right arm) — 160

Missile Launcher (1, on back) — 100

Arms (2) — 180 each

Legs (2) — 220 each

* Head — 120

** Main Body — 400

* Destroying the sensor head of the bot will eliminate all forms of optical enhancement and sensory systems. The pilot must then rely on his own human vision and senses without bonuses to strike, parry, and dodge from the bot.

** Depleting the M.D.C. of the main body will shut the armor down completely, making it useless.

Speed:

Running: 90 mph (144 km)

Flying: Not possible

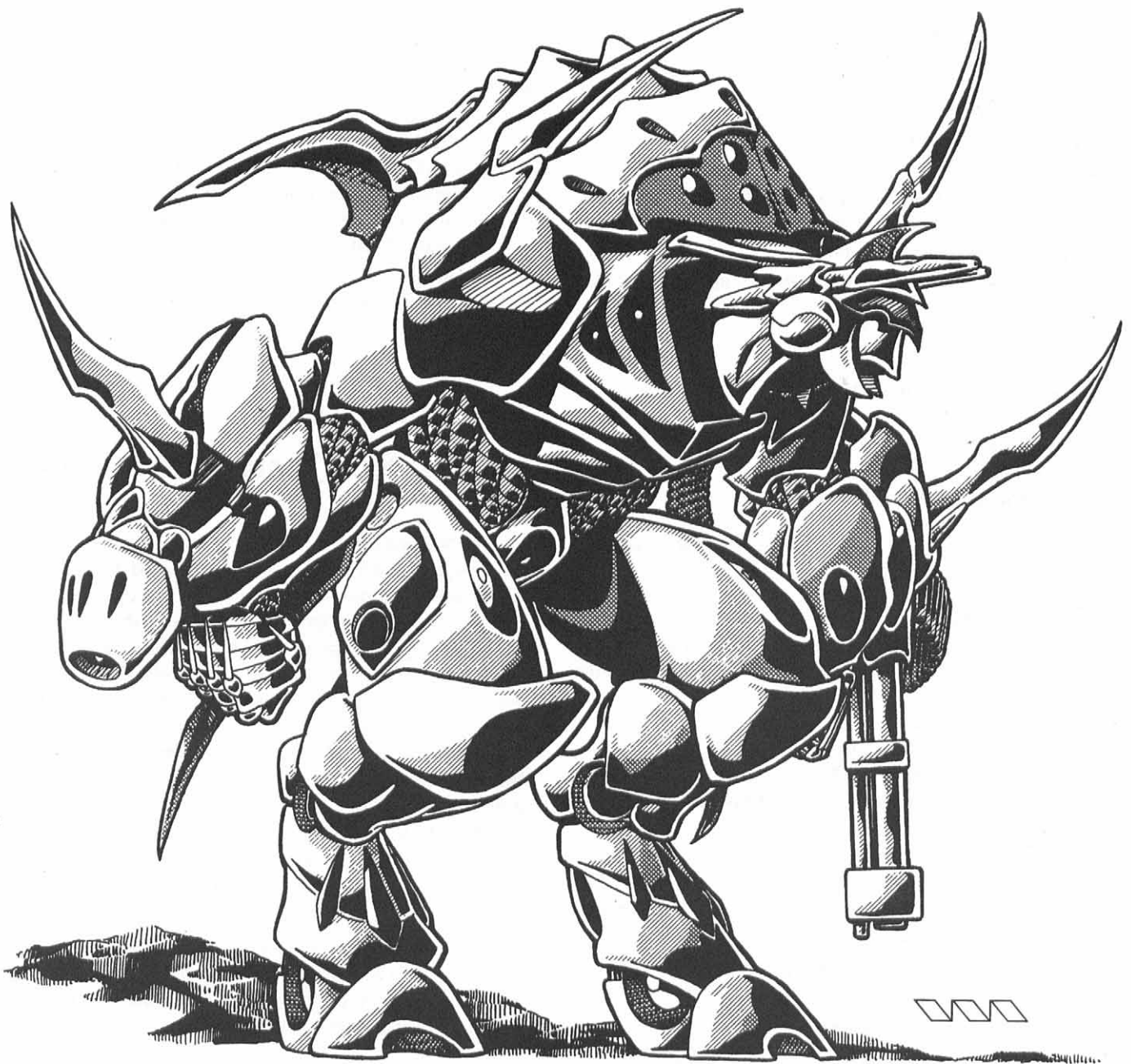

Statistical Data:

Height: 12 feet (3.7 m)

Width: 6 feet (1.8 m)

Length: 6 feet (1.8 m)

Weight: 1 ton (907 kg)

Physical Strength: Equal to pilot's P.S. +6 (supernatural); only Kreeghor can use the suit.

Cargo: None.

Power System: Antimatter; average energy life is 50 years

Market Cost: 5.5 million credits.

Weapon Systems

1. Gravity Autocannon: A heavy rail gun-like gravity weapon that fires high-density pellets at great speed. It is mounted on the left arm and feeds off a magazine built on to the back.

Primary Purpose: Anti-armor

Secondary Purpose: Anti-personnel

Mega-Damage: 40 round burst inflicts 1D6×10+10 M.D.; can only fire bursts.

Rate of Fire: Equal to number of combined hand to hand attacks.

Effective Range: 4000 feet (1200 m)

Payload: 4000 round drum; that's 100 bursts.

2. Particle Beam Gun: This gun has less range but more power than the gravity autocannon, and is used as the main anti-robot and anti-tank weapon of the suit.

Primary Purpose: Anti-armor

Secondary Purpose: Anti-personnel

Mega-Damage: 2D4×10 M.D. per blast.

Rate of Fire: Equal to number of combined hand to hand attacks per melee.

Effective Range: 1000 feet (305 m)

Payload: Effectively unlimited

3. Missile Launcher: The back of the Warlord holds a mini-missile launcher holding 12 mini-missiles in two superimposed rows.

Primary Purpose: Anti-aircraft

Secondary Purpose: Anti-personnel

Mega-Damage: Varies with missile type.

Rate of Fire: One at a time or in volleys of two, four, six, eight or twelve.

Effective Range: About one mile (1.6 km).

Payload: 12 missiles.

4. Head Lasers (2): Mounted on each side of the head is a light laser. The guns are designed to fire simultaneously as a quick-reaction weapon.

Primary Purpose: Anti-personnel

Secondary Purpose: Defense

Mega-Damage: 3D6 M.D. per gun or double blast 6D6 M.D.; either counts as one attack/action.

Rate of Fire: Equal to number of combined hand to hand attacks.

Effective Range: 2000 feet (610 m)

Payload: Effectively Unlimited.

5. Forearm Blades: These long, slashing blades can be extended sideways and used in close combat. The blades do 4D6 M.D. in addition to hand to hand damage.

6. Hand to Hand Combat: Rather than use a weapon, the pilot can engage in mega-damage hand to hand combat. See Basic and Elite Power Armor Combat Training in the Robot Combat section of **Rifts**, page 45. All abilities are the same except damage, which uses the supernatural strength of the wielder.

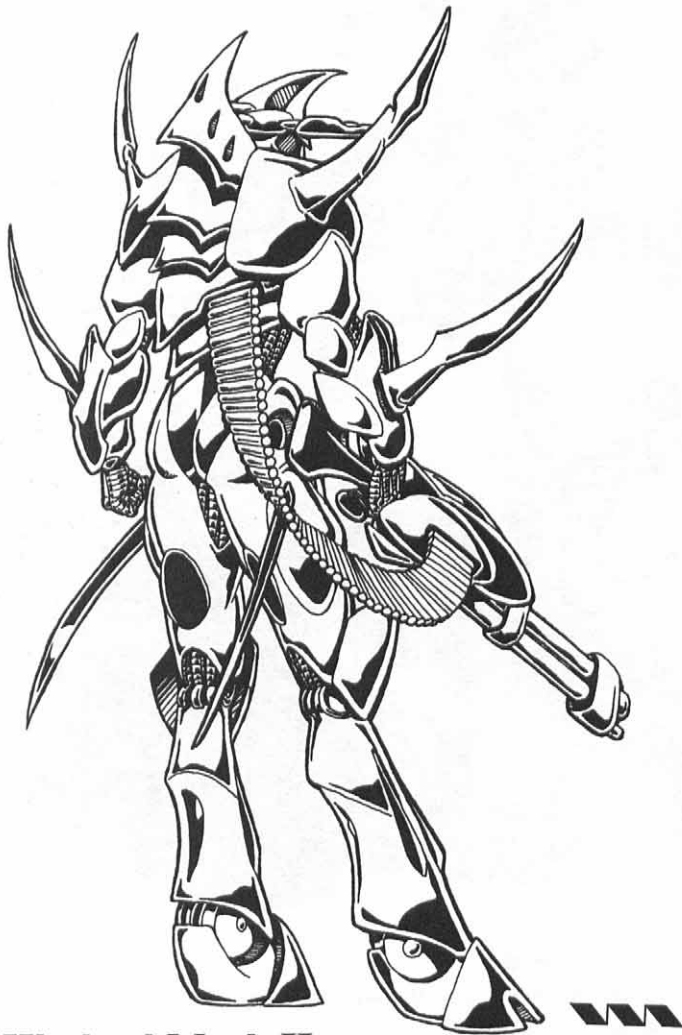

Warlord Mark II Combat Suit (Transgalactic Empire)

The Warlord Mark II is designed to fit most humanoid races who fight as soldiers for the Transgalactic Empire, including humans and wolfen. Its basic styling and design are similar to the Mark I, including the forearm blades, but it is a smaller and less-

well protected suit of armor. Also, instead of two main weapon systems, it only has the gravity autocannon, but it can fly.

Model Type: IPA-WI-H

Class: Assault Exoskeleton

Crew: One

M.D.C. by Location:

Gravity Autocannon (rifle) — 190

Missile Launcher (1, on back) — 100

Arms (2) — 150 each

Legs (2) — 200 each

* Head — 100

** Main Body — 320

* Destroying the sensor head of the bot will eliminate all forms of optical enhancement and sensory systems. The pilot must then rely on his own human vision and senses without bonuses to strike, parry, and dodge from the bot.

** Depleting the M.D.C. of the main body will shut the armor down completely, making it useless.

Speed:

Running: 90 mph (144 km)

Flying: In outer space, it can reach Mach 7. In an atmosphere, maximum flying speed is Mach 1.

Statistical Data:

Height: 10 feet (3.1 m)

Width: 6 feet (1.8 m)

Length: 5 feet (1.5 m)

Weight: 1500 lbs (680 kg)

Physical Strength: Equal to a P.S. of 40

Cargo: None.

Power System: Anti-matter; average energy life 50 years

Market Cost: 4 million credits.

Weapon Systems

1. Gravity Autocannon: This is a rifle-shaped version of the gravity gun mounted on the Warlord Mark I.

Primary Purpose: Anti-armor

Secondary Purpose: Anti-personnel.

Mega-Damage: 40 round burst inflicts 1D6×10+10 M.D.; can only fire bursts

Rate of Fire: Equal to number of combined hand to hand attacks.

Effective Range: 4000 feet (1200 m)

Payload: 4000 round drum; that's 100 bursts.

2. Missile Launcher: The back of the Warlord holds a mini-missile launcher holding 12 mini-missiles in two superimposed rows.

Primary Purpose: Anti-aircraft

Secondary Purpose: Anti-personnel

Mega-Damage: Varies with missile type.

Rate of Fire: One at a time or in volleys of two, four, six, eight or twelve.

Effective Range: About one mile (1.6 km).

Payload: 12 missiles.

3. Head Lasers (2): Mounted on each side of the head is a light laser. The guns are designed to fire simultaneously as a quick-reaction weapon.

Primary Purpose: Anti-personnel

Secondary Purpose: Defense.

Mega-Damage: 3D6 M.D. per gun or double blast 6D6 M.D.; either counts as one attack/action.

Rate of Fire: Equal to number of combined hand to hand attacks.

Effective Range: 2000 feet (610 m)

Payload: Effectively Unlimited

4. Forearm Blades: These long, slashing blades can be extended sideways and used in close combat. The blades do 3D6 M.D. in addition to hand to hand damage.

5. Hand to Hand Combat: Rather than use a weapon, the pilot can engage in mega-damage hand to hand combat. See Basic and Elite Power Armor Combat Training in the Robot Combat section of *Rifts*, page 45. All abilities are the same except as follows:

Restrained Punch — 1D4 M.D.

Full Strength Punch — 2D6 M.D.

Power Punch — 4D6 M.D.

Kick — 2D4 M.D.

Leap Kick — 3D6 M.D.

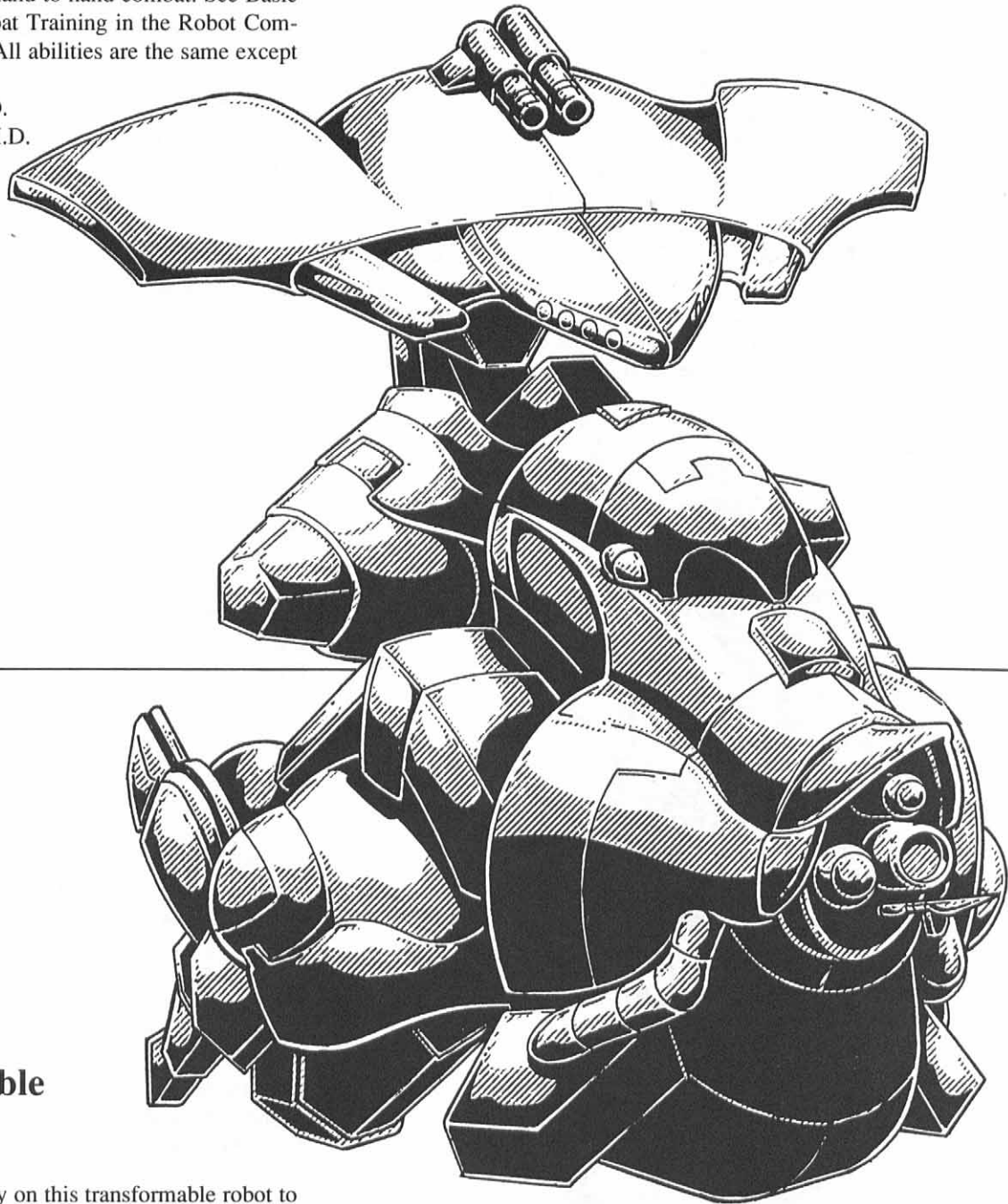

Kittani Transformable Robot-Fighter

The Splugorth space fleets rely on this transformable robot to cover the needs of both space fighters and war robots. The designs for the Robot-Fighter are similar to the Kittani Land Skimmer (see *Rifts Atlantis*, page 156), only much larger, heavily armored and with an assortment of weapon systems, as well as the ability to fly in and out of an atmosphere. Typically, the Robot-Fighter is deployed from Dragon Dreadnoughts (see *Rifts Atlantis*) or large Kittani or Kydian spaceships.

Model Type: K-TRF-M

Class: Robot-Fighter Vehicle

Crew: One

M.D.C. by Location:

Pulse Cannons (2, on the wings or shoulders, heavily armor plated) — 150 each

Forearm Blades (2) — 75 each

Mini-Missile Launchers (2, sides or torso) — 100 each

Arms (2) — 170 each

Legs (2) — 220 each

Reinforced Pilot's Compartment (chest) — 100

Head/Laser Turret — 180

* Destroying the sensor head will eliminate all forms of optical enhancement and sensory systems. The pilot must then rely on his own human vision and senses without bonuses to strike, parry and dodge from the bot.

** Main Body — 450

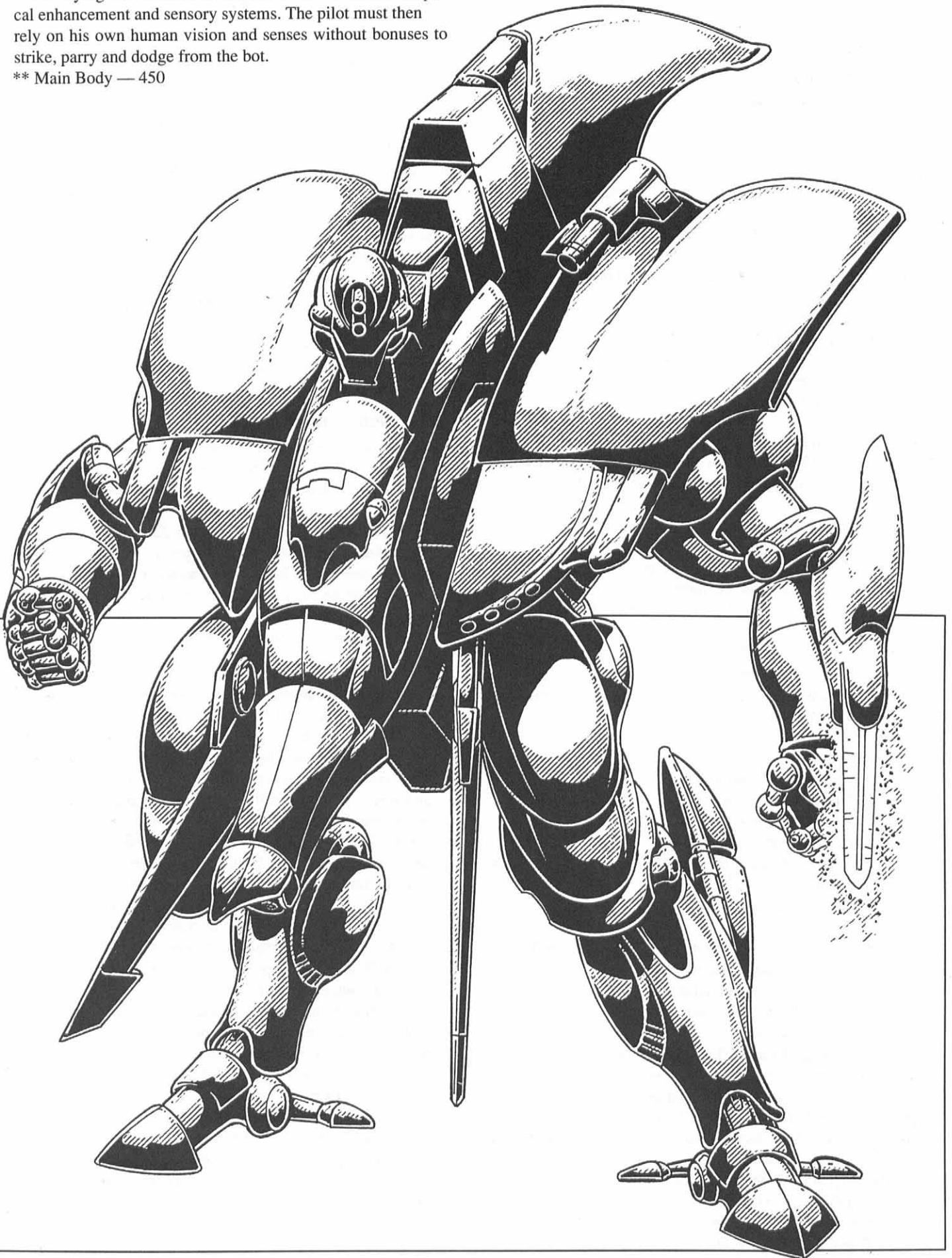

** Depleting the M.D.C. of the main body will shut the armor down completely, making it useless.

Speed:

Running: 60 mph (96 km) in humanoid form; running is not possible in fighter form.

Flying: Mach One in humanoid form or Mach 7 (Mach 9 in space) in fighter form.

Range: Effectively unlimited.

Statistical Data:

Height: 15 feet (5.6 m) standing on its legs, about half that in fighter form.

Width: 7 feet (2.1 m) in humanoid form, or 30 feet (10 m) in fighter form.

Length: 6 feet (1.8 m) in humanoid form, or 30 feet (10 m) in fighter form.

Weight: 5 tons (4,500 kg).

Physical Strength: Equal to a P.S. 40.

Cargo: A small 3x3 foot (0.9x0.9 m) area.

Power System: Nuclear; average energy life is 25 years.

Market Cost: 8 million credits.

Weapon Systems

1. Pulse Cannons (2): These twin pulse cannons are mounted on the wings of the fighter form or the shoulders of the humanoid form.

Primary Purpose: Anti-aircraft

Secondary Purpose: Defense

Mega-Damage: 1D4x10 per single blast, or 2D4x10 per simultaneous double blast (counts as one melee attack).

Rate of Fire: Equal to the pilot's combined hand to hand attacks per melee.

Effective Range: 4000 feet (1200 m)

Payload: Effectively unlimited.

2. Mini-Missile Launchers (2): Two launchers are mounted on the sides of the fighter/robot.

Primary Purpose: Anti-aircraft

Secondary Purpose: Defense

Mega-Damage: Varies with missile type.

Rate of Fire: One at a time or volleys of two, four, or eight

Effective Range: About one mile (1.6 km).

Payload: 16 missiles, eight per launcher.

3. Laser Turret: The head of the robot has twin lasers that convert to a laser turret in the fighter form.

Primary Purpose: Anti-armor

Secondary Purpose: Defense

Mega-Damage: 4D6 per single blast or 1D6x10+6 M.D. per double blast (counts as one melee attack)

Rate of Fire: Equal to combined hand to hand attacks.

Effective Range: 4000 feet (1200 m)

Payload: Effectively unlimited.

4. Forearm Energy Blades: The arms of the humanoid form have two energized blades that inflict 1D4x10 M.D. when powered up or 1D4 M.D. when used as blunt weapons.

5. Hand to Hand Combat: Rather than use a weapon, the pilot can engage in mega-damage combat. See Basic and Elite Power Armor Combat Training in the Robot Combat section of *Rifts*, page 45. All abilities are the same except as follows:

Restrained Punch — 1D4 M.D.

Full Strength Punch — 2D4 M.D.

Power Punch — 3D6+6 M.D.

Kick — 2D6 M.D.

Leap Kick — 4D6 M.D.

Other Equipment

The advanced technology of the Three Galaxies has produced a number of scientific wonders. Besides the gadgets described below, any piece of equipment described in the *Rifts* books (or an equivalent) can be found in most civilized areas of the Three Galaxies. Prices will be between 1/3 and 1/10 of what they are on Rifts Earth! Keep in mind that these worlds are not struggling to rise from an epic disaster and they have mass-production facilities that are only dreamt about on the shattered planet. Only in weapons are the prices roughly equivalent, because most of Rifts Earth's manufacturing capacity is dedicated to military industry — a sad fact of this war-torn world.

E-Clips are dramatically cheaper in the Three Galaxies. The equivalent of an Earth E-Clip costs 250 credits fully charged! They are not directly compatible with Rifts equipment, however, and either the weapon or the clip has to be altered somewhat (this adds 150 credits to the cost of the clip; weapon modifications go for 1,000 to 2,000 credits).

Cybernetic Equipment

All the cybernetics and bionic systems described in *Rifts*, page 229 to 243, can be purchased on various planets in the Three Galaxies, usually for 20% to 30% less money than what they cost on Earth. The only common implant used by the public is the Universal Headjack (*Rifts*, page 230), which allows people to interact directly with their computers. Universal headjacks cost 2,000 credits, including the operation, which can be performed in half an hour on an advanced planet. The price and risks of the operation go up (while availability goes down) in more remote areas or primitive worlds.

Medical Equipment

Blood and Tissue Builder (BTB) Injectors/Spray: Each dose comes in a small tube that can be either injected by pressing against the skin or sprayed on a wound. The BTB is a chemical/biological compound that increases healing a hundred-fold, containing basic proteins that will replace lost blood, and which will bond with and duplicate any damaged living tissue, knitting wounds instantly! The first dose of a BTB will restore 2D6 S.D.C./hit points. However, successive doses are less effective; amount healed is at -1 per additional doses. This is cumulative, so the sixth dose of BTB would only restore 2D6 -6 points, with an almost even chance of not doing anything for the patient. The healing will not bring a victim out of a coma, only medical treatment can do that, but the BTB will add a 5% bonus to recovery rolls. BTB will only work on damaged tissues and organs. Some toxins damage tissues directly and their damage will be healed by the BTB; others, like curare, are actually powerful muscle relaxants and their effects will be unaffected by this medicine. The G.M. must rule whether or not the BTB will repair damage caused by a poison/toxin.

BTB injectors are species-specific. A different BTB exists for humans, Wolfen, Noro and so on. Using it on another species may trigger allergies or tissue rejection, with damaging effects! If a BTB for a wrong species is used on a patient, roll percentile dice to determine the results:

01-05% The BTB works!

06-10% The BTB works at half power.

11-80% The BTB does not work at all.

81-00% The BTB does 1D6 damage to the patient and causes nausea or headaches.

Cost: Each dose of BTB, with a disposable injector/spray, costs 1000 credits.

Universal Anti-Toxin (UAT): This is a wide-spectrum antidote that will work against 100,000 known poisons, venoms and toxins. Its components are mutable chemicals that will shift at the molecular level to neutralize harmful toxic elements. This gives the patient a +10 bonus to saves against poison. The UAT will not heal damage already done by the poison, however.

Miscellaneous Equipment

Holographic Personal Computer (HPC): This is a wristwatch-sized computer that projects a larger holographic screen in front of the user. It works on both voice commands and by "touching" the holographic buttons. The tiny microchip that powers this computer has 500 gigabites (500,000 megabytes) of RAM and a storage capacity of 5,000 gigabytes. The equivalent of a dozen Encyclopedia Britannica databases can be easily stored in this tiny device, providing instant access to mountains of information. **Cost:** 1,500 credits for the computer (includes all basic programs) and 100 to 500 credits for extra programs, databases, etc. For an additional 250 credits, a headjack cord allows the user to directly "plug into" his computer for faster processing.

Metal-Spray: The latest in armor repair equipment, this spray can allow for limited field repairs on body armor, robots and vehicles. The spray secretes a super-epoxy and metal alloy that seals gaps in armor by becoming a rapid-hardening M.D.C. foam. One treatment on a suit of power armor, robot or vehicle will repair 1D4×10 M.D.C. to large structures (i.e., armor/structures with more than 140 M.D.C.) or 4D6 M.D.C. to small components and body armor. The spray will only work if the component/structure/armor has not been destroyed; its remaining M.D.C. must be one or greater. Only a maximum of 40 M.D.C. for large or 24 M.D.C. for small structures will be restored, even with multiple applications. Each can has enough juice for three applications. **Cost:** 4,000 credits. It comes in three colors: black, gray and green. The armor may have unsightly patches of different colors, but it will be in better shape! The material can be painted for those who want to do so.

Virtual Reality Goggles/Helmet: A complete entertainment center that projects three-dimensional images and full sound into a set of goggles with earphones, completely immersing the user in the projection. Goggles are not as effective as the helmet in isolating the user from the real world, but they are cheaper. The set uses micro-CDs that will run 1 to 8 hours' worth of programming. This set does not allow for interaction; the user is just along for the ride. **Cost:** 2,000 credits. Each CD "movie" costs 20 to 1000 credits, depending on how popular or intense it is.

Virtual Reality Game Dude™: The Game Dude™ is a VR helmet that connects directly to a universal headjack. This set allows the user to fully interact with the projected VR environment. A typical Game Dude™ user will just lie there, his limbs occasionally spasming, while he adventures in a fictional reality. All sorts of programs are available, from blood-

'n-guts action games to "adult" entertainment. Game Dude™ addiction is a problem on advanced planets. People who live on the fringes have a lot less time to waste on stupid games. **Cost:** The basic game costs 800 credits. Typical game cartridges cost 70 to 200 credits, depending on how popular or complex it is.

Multitool: This hand tool is the equivalent of a super-Swiss Army Knife. It uses nano-technology to reconfigure a metal rod with a pistol grip into any of 500 programmed shapes, from a powered screwdriver to a bolt-cutter, hammer, chip-welder, pliers, drill, and many other tools, in every possible calibration. It can reach a length of 4 feet (1.2 m), allowing the user to reach deep into engines. Having a multitool will give the owner almost the equivalent of a full mechanic's kit. The multitool can even be reconfigured into a weapon like a welder-ax that inflicts 2D6 M.D. in hand to hand combat! Multitools are powered by E-Clips or civilian batteries (the two models are not interchangeable; most adventurers prefer the former). **Cost:** 25,000 credits.

Restraint Dispenser: This substitute for handcuffs looks like an oversized floss dispenser, hand-sized and with a pistol grip. By pressing a button, the dispenser releases a sticky wire that can be used to secure the wrists and ankles of a captive. The wire tightens and hardens quickly and has tremendous tensile strength. It can only be broken by characters with a P.S. of 30 or higher; if the victim is thoroughly wrapped, this goes up to 45 or higher! The bonds can be melted away with a chemical spray that causes its polymers to break down in 1D6 melee rounds. If the spray is not applied, the restraints will break down in contact with air after 1D4 days. The wire can also be cut, but it takes 10 M.D.C. to slash through it. A dispenser has enough wire to secure 20 humanoids (only 5 if they are wrapped like mummies). **Cost:** 5,000 credits.

Tanks & Infantry Fighting Vehicles

"Bombard" Infantry Robot (CAF)

The Bombard is a medium-sized robot used by the Consortium's Armed Forces. A big, solid and dependable vehicle, the Bombard is used to support ground attacks, and can be configured to carry a number of heavy shoulder-mounted weapon systems, including anti-aircraft, heavy cannons, and multi-missile launcher modular weapons. Bombards are usually deployed in swamps, jungles and forests where tanks and other conventional vehicles cannot operate efficiently.

The robot has no head and in general is less humanoid than typical robots found on Rifts Earth, or those produced by Naruni Enterprises. Instead of a head, most bombards carry a number of modular weapon pods that can be reconfigured depending on the mission. The arms and hands are oversized and have more reach than most robots of the same size.

Bombards are organized along the same lines as tanks, divided in platoons of three robots and companies of twelve. They are usually attached to other infantry units, such as Ground

Pounder power armor or regular infantrymen. Besides the CAF, many planetary defense forces in the Consortium and some independent worlds have purchased thousands of these robots. Some cheap knock-offs (reduce price by 30%, but M.D.C., performance and weapon systems will be reduced by 50%) are produced by pirate factories and sold to mercenaries and criminals.

Model Type: CAF-AR-20

Class: Ground Infantry Assault Robot with multiple weapon systems.

Crew: Three: One pilot, one co-pilot/gunner and a gunner/communications officer. Can carry one additional passenger.

M.D.C. by Location:

Weapon Pod (one where the head should be) — 350

Plasma Cannons (two, one on each shoulder) — 150 each

Rail Gun “Accordion” (8 guns, 2 rows of 4, upper torso) — 200

Forearm Missile Launchers (two, one in each arm) — 100 each

Leg Missile Launchers (2) — 100 each

Legs (2) — 240 each

Arms (2) — 200 each

* Hands (2) — 90 each

* Sensor Arrays (4) — 75 each

Reinforced Pilot’s Compartment — 150

** Main Body — 600

* A single asterisk indicates small or difficult targets to hit. They can only be struck when an attacker makes a called shot, and even then the character is -2 to strike. If all four sensor arrays are destroyed, the pilot and gunners must then rely on their own human vision and senses without bonuses to strike, parry and dodge from the bot.

** Depleting the M.D.C. of the main body will shut the armor down completely, making it useless.

Speed:

Running: 70 mph (122.6 maximum).

Leaping: 20 feet (6.1 m) high or lengthwise from a standing still position; 30 feet (9.1 m) high or 40 feet (13.7 m) lengthwise from a running start.

Flying: Not possible

Statistical Data:

Height: 30 feet (9.1 m) with weapons pod attached, or 25 feet (7.6 m) without.

Width: 12 feet (3.6 m) from shoulder to shoulder.

Length: 7 feet (2.1 m)

Weight: 20 tons fully loaded or 18 tons without weapons pod.

Physical Strength: Equal to a P.S. 50

Cargo: Small area for crew’s personal items.

Power System: Anti-Matter; average energy life of 50 years.

Market Cost: 50 million credits.

Weapon Systems

1. Plasma Cannons (2): Mounted on each shoulder is a plasma cannon with great range and penetrating power. They are mostly used against other robots and tanks.

Primary Purpose: Anti-armor

Secondary Purpose: Assault

Mega-Damage: 2D4×10 per single blast, or 4D4×10 for combined double blast (counts as two melee attacks)

Rate of Fire: Equal to number of combined hand to hand attacks

Effective Range: 4000 feet (1200 m)

Payload: Effectively unlimited.

2. Rail Gun “Accordion”: This devastating weapon is designed to slaughter infantrymen in front of the robot. The “accordion” consists of eight rail guns stacked in two rows. The guns’ barrels can be aimed by the pilot or gunner to “bracket” an area of up to 30 feet (9 m) in front of the bot. Everybody in the area is “hosed” by rail gun pellets. A large target (12 feet/3.6 m) or larger takes more damage than human-sized targets, as it will be struck by more rounds. The Accordion can also be used to knock down incoming missile fire (and is +1 to strike incoming missiles).

Primary Purpose: Anti-Personnel

Secondary Purpose: Defense.

Mega-Damage: A burst is 40 rounds per gun (a total of 320 rounds!) and does 1D4×10 M.D. to everything and everybody in a 30 foot (9 m) path directly in front of it. Targets larger than 12 feet (3.6 m) tall or across take 2D4×10 M.D. Can only fire bursts.

Rate of Fire: Equal to number of combined hand to hand attacks

Effective Range: 1000 feet (305 m)

Payload: 6000 rounds per gun; 150 bursts total.

3. Forearm Missile Launchers (2): These two mini-missile launchers are used as a secondary defensive weapon.

Primary Purpose: Defense, anti-personnel.

Secondary Purpose: Anti-aircraft

Mega-Damage: Varies with missile type.

Rate of Fire: One, two or four missiles per volley.

Effective Range: About one mile (1.6 km).

Payload: Eight total; four in each arm.

4. Leg Missile Launchers (2): Two large capacity mini-missile launchers are located on the outside of each lower leg.

Primary Purpose: Anti-aircraft and anti-personnel

Secondary Purpose: Defense

Mega-Damage: Varies with missile type (usually plasma: 1D6×10 M.D.)

Rate of Fire: One at a time or in volleys of two, three, four or six missiles.

Effective Range: About one mile (1.6 km).

Payload: 32 total; 16 in each leg.

5. Optional Head Weapons Pods (1): Any one of the following can be selected.

Missile Pod (optional): This is one of the three weapon pods that can be mounted on the Bombard (head area). Only one weapon pod can be attached and used at a time. The missile pod has 10 medium-range missiles stacked in two rows of five, and a smaller launcher with 12 mini-missiles on top of it. Under optimal conditions, the robot can reload the pod from a supply truck in 10 minutes. Missile pods are issued when regular MLRS (multiple-launch rocket system) vehicles cannot operate in the area.

Primary Purpose: Anti-aircraft and area bombardment.

Secondary Purpose: Anti-personnel and anti-armor.

Mega-Damage: Varies with missile type (has medium-range and mini-missiles)

Rate of Fire: One at a time or in volleys of two, four, or eight.

Effective Range: About one mile (1.6 km) for mini-missiles, about 50 miles (80 km) for medium-range missiles.

Payload: 10 medium-range missiles and 12 mini-missiles.

Laser Pod (optional): A heavy laser cannon commonly issued to provide air defense or to engage enemy tanks and giant robots.

Primary Purpose: Anti-armor and anti-aircraft.

Secondary Purpose: Defense

Mega-Damage: 3D4×10 M.D. per laser burst.

Rate of Fire: Equal to number of combined hand to hand attacks per melee.

Effective Range: One mile (1.6 km)

Payload: Effectively unlimited

Mortar Pod (optional): This pod is commonly issued to Bombers engaged in regular infantry combat. The automatic mortar (actually, two mortars firing side by side) fire smart bomb rounds that can alter their course to hit a target within 200 feet (61.0 m) of their landing spot. The load is a combination of armor piercing and fragmentary rounds to deal with both infantry and vehicles. Most of the pod is filled with ordnance.

Primary Purpose: Anti-personnel

Secondary Purpose: Anti-armor

Mega-Damage: 1D4×10 M.D. (armor piercing) or 4D6 M.D. (fragmentary). Armor piercing mortar rounds can be dodged; fragmentary ones inflict damage to a 20 foot (6 m) area. A burst of 10 mortar rounds does fragmentary damage to a 200 foot (61 m) area.

Rate of Fire: Single shots or bursts of 10 rounds; each counts as one melee attack.

Effective Range: Two miles (3.2 km)

Payload: 200 rounds (100 fragmentary and 100 armor piercing)

6. Hand to Hand Combat: Rather than use a weapon, the pilot can engage in mega-damage hand to hand combat.

Bonuses & Damage from Bombard Combat Training:

Restrained Punch — 1D6 M.D.

Full Strength Punch — 2D6 M.D.

Power Punch — 4D6 M.D. (counts as two attacks)

Vibro-blade — 4D6 M.D.

Crush, Pry or Tear — 1D6 M.D.

Kick — 2D6 M.D.

Body Flip/Throw — 1D6 M.D.

Body Block/Ram — 2D4 M.D.

Stomp — 2D4 M.D. against man-sized targets

+2 to strike

+4 to parry

+2 to dodge

+3 to roll with impact

+4 to pull punch

+2 melee actions/attacks at level one

+1 additional melee action/attack at levels 4, 6, 9, and 12.

Note: Reduce combat bonuses by half if there is no co-pilot or gunner. Also, reduce the number of attacks per melee by two if either co-pilot or gunner is missing, or by three if the pilot is alone.

Phalanx Main Battle Tank (CAF/Wolfen)

The Phalanx is one of the oldest vehicle designs still in service in the Consortium Armed Forces. The first prototypes were employed by the Wolfen Empire in its wars of conquest, centuries ago. The wolfen wanted a vehicle that would outgun all others and to this date, it remains one of the most heavily armed

tanks of the Three Galaxies. The current model is fundamentally the same, with only a few modifications.

This contragravity vehicle is almost as fast and maneuverable as an aircraft, but it has enough armor and weapons to handle any land vehicle. Its name comes from the five weapon systems whose barrels point menacingly forward, reminiscent of the lines of spearmen of the Wolfen Empire's past.

The Phalanx has an oversized turret with two different cannons, a cupola on top with a heavy autocannon, and two powerful weapons on its front hull. Additionally, it has a small Multiple Launch Rocket System (MLRS) behind the turret used to deal with enemy aircraft and missiles, or to engage in medium-range bombardment. Each gunner has his own armored battle station from which he can control one major weapon system. The Phalanx also has a heavy-duty force field that is projected along the front of the tank only. The limited area of the field gives it greater density than average, making the tank nearly impervious to frontal attacks. The usual deployment of the Phalanx calls for lighter vehicles, power armor and robots to screen the tank's relatively vulnerable flanks.

Phalanx MBTs are usually carried aboard military spaceships as part of their landing forces. A few divisions are also scattered along trouble spots of the CCW, serving garrison duty. Over the years, mercenary companies and independent worlds have managed to get their hands on some of these tanks. Some imitation Phalanx also appear in the black market, although their quality is greatly reduced.

Model Type: MBT-35 CAF

Class: Main Battle Tank

Crew: Eight: pilot, commander, communication officer and five gunners.

M.D.C. by Location:

Laser Cannon (turret, left) — 200

Gravity Cannon (turret, right) — 200

Gravity Autocannon (cupola on top of turret) — 120

** Turret — 600

Particle Beam Cannon (main body, right) — 200

200 mm Flechette Gun (main body, left) — 180

MLRS (behind turret) — 160

Laser Mini-turrets (2, front sides) — 70 each

* Main Body — 950

Gunner Compartments (5) — 80 each

Pilot's Compartment — 200

Force Field (protects front 1/3 of the vehicle only) — 700

* Depleting the M.D.C. of the main body destroys the vehicle.

** Destroying the turret prevents the use of all its weapon systems.

Speed:

Driving on the ground: 200 mph (320 km) maximum. The Phalanx's contragravity system allows it to make very tight turns, change directions unexpectedly, and float over any obstacle.

Flying: Limited flying abilities. Unlike conventional hover vehicles, the Phalanx uses a contragravity system and can fly at speeds of 120 mph (192 km) to a maximum altitude of 1000 feet (305 m) in the air. The disadvantage of flying is that the tank is designed to fight close to the ground. In the air its under belly is

vulnerable and its weapon systems are at -4 to strike any object beneath it (no penalties at shooting those in front or above it).

Note: The Phalanx is not a hover tank. It does not have vulnerable fans or thrusters underneath.

Statistical Data:

Height: 24 feet (8 m)

Width: 30 feet (9 m)

Length: 40 feet

Weight: 250 tons

Cargo: Minimal storage space: about four feet (1.2 m) for extra clothing, weapons and personal items.

Power System: Anti-matter; average energy life of 30 years

Market Cost: 150 million credits for a fully operational and equipped phalanx. A partially rebuilt tank: reduce M.D.C. by 30%, and force field power by 50%, costs between 90 and 120 million credits.

Cheap black market imitations: Reduce M.D.C. and force field by 40% to 50% (half the knock-offs don't have the force field) and no gravity cannons (replace with plasma ejector with half the range), and eliminate one of the other five main weapon systems. Cost: between 60 and 80 million credits.

Weapon Systems

1. Laser Cannon: A heavy laser cannon is one of the two pieces on the front of the turret. It is designed to be aimed independently from the gravity cannon next to it. Each gun has its own gunner.

Primary Purpose: Anti-armor

Secondary Purpose: Anti-aircraft

Mega-Damage: 2D6×10 M.D. per energy pulse.

Rate of Fire: Equal to the number of combined hand to hand attacks of the gunner.

Effective Range: 2 miles (3.2 km)

Payload: Effectively Unlimited.

2. Gravity Cannon: This heavy gravity cannon fires solid depleted uranium slugs that have enormous penetration at short and medium range.

Primary Purpose: Anti-armor

Mega-Damage: 4D6×10 M.D. per shot.

Rate of Fire: Equal to the number of combined hand to hand attacks of the gunner.

Effective Range: 4000 feet (1220 m)

Payload: 40 shots

3. Gravity Autocannon: This rapid-fire gun is located on a cupola on top of the main turret and is operated by either the tank commander or one of the turret's two gunners. It can rotate 360 degrees up and sideways, enabling it to engage airborne and land targets.

Primary Purpose: Anti-aircraft

Secondary Purpose: Anti-personnel and anti-armor.

Mega-Damage: A burst is 40 rounds and does 1D6×10+10 M.D. Can only fire bursts.

Rate of Fire: Equal to the number of combined hand to hand attacks of the gunner.

Effective Range: 4000 feet (1220 m)

Payload: 8000 rounds; that's 200 bursts

4. Particle Beam Cannon: A particle beam cannon is one of the two guns mounted on the front of the tank. It has relatively short range, but in its second setting it has the nasty ability to bathe a large area with lethal particle streams; very useful in clearing out massed infantry formations.

Primary Purpose: Anti-armor and anti-personnel.

Secondary Purpose: Defense

Mega-Damage: Two settings: The first setting fires a concentrated beam and does 1D6×10 M.D. The second setting inflicts 6D6 M.D. to an area 50 feet (15.2 m) in diameter up to a 600 feet (183 m) away.

Rate of Fire: Equal to the number of combined hand to hand attacks of the gunner.

Effective Range: 2000 feet (610 m) for the first setting, and 600 feet (183 m) for the second.

Payload: Effectively unlimited.

5. 200 mm Flechette Gun: This weapon is somewhat similar to the Glitter Boy's Boom Gun, firing hundreds of small projectiles with every shot. The Flechette Gun is equally effective against heavily armored targets, or to mow down infantrymen. The gun's projectiles scatter in a shotgun pattern, doing a great deal of damage to the one largest target and less damage to several smaller ones. The gun is also useful to shoot down incoming missiles (+2 to shoot missiles aimed at the front of the tank only). It can traverse up to 90 degrees up, so it has limited anti-aircraft capabilities.

Primary Purpose: Anti-armor and anti-personnel.

Secondary Purpose: Defense

Mega-Damage: Against a large target (10 feet/3.0 m tall/wide or higher), the flechette gun does 3D4×10 M.D. Against human sized targets, the flechettes do 1D4×10 M.D. to an area 30 feet (9.1 m) in diameter.

Rate of Fire: Equal to the number of combined hand to hand attacks of the gunner.

Effective Range: 6000 feet (1890 m)

Payload: 200 rounds.

6. MLRS: This Multiple Launch Rocket System is an auto-loading missile launcher operated by its own individual gunner. The MLRS can engage airborne and ground targets.

Primary Purpose: Anti-aircraft and anti-personnel.

Secondary Purpose: Defense

Mega-Damage: Varies with missile type. Standard issue is half fragmentation (5D6 M.D.) and half plasma (1D6×10 M.D.)

Rate of Fire: One at a time or in volleys of 2, 4, 8 or 12 missiles.

Effective Range: About one mile (1.6 km).

Payload: 48 missiles total. After the launcher fires the 12 missiles, it takes one melee round (15 seconds) to recycle another twelve from the tank's missile magazine.

7. Laser Mini-Turrets (2): These side-mounted weapons can be operated by the pilot, the tank commander or the communication officer and are used for defense against infantry and missiles.

Primary Purpose: Anti-personnel

Secondary Purpose: Defense

Mega-Damage: 4D6 per blast single blast (cannot be fired in tandem).

Rate of Fire: Equal to the number of combined hand to hand attacks of the gunner.

Effective Range: 2000 feet (610 m)

Payload: Effectively unlimited.

Maniple IFV APC (CAF)

This vehicle is an old design originally used by the Wolfen Empire and named after one of its old military units. The Consortium Armed Forces were looking to replace its light, armored personnel carriers. The Maniple Infantry Fighting Vehicle fit the bill, ensuring greater troop survivability, and was adopted.

The Maniple has a dual mission: To act as a medium-class tank and to transport a power armor platoon to the field. Four of these APCs can be transported in a standard military assault shuttle, making it an ideal vehicle for planetary assaults.

The Maniple is a hover vehicle, floating on an air cushion and helped along by a contragravity system that enhances its maneuverability. This makes it one of the fastest land vehicles available. While not as powerful as a main battle tank, it can engage tanks or high-powered robot assault vehicles and have a reasonable chance of survival. Add in its 12-man power armor squad (or 36 infantry soldiers) with their firepower, and a Maniple's odds of winning the encounter become even better. The powered infantry can also scout ahead to clear out enemy infantry units (always a danger to tanks at close range), detect and harass enemy formations, or make surgical strikes. A single Maniple can also be detached to garrison duty, protecting small military or scientific facilities or even protecting an entire planetary colony.

Model Type: IFV-100 CAF

Class: Infantry Fighting Vehicle

Crew: Three: Pilot, gunner and commander/gunner.

Troop Capacity: Can carry up to 12 soldiers in power armor or 36 troopers in combat armor.

M.D.C. by Location:

Laser Cannon (in turret) — 100

Missile Launchers (2, turret sides) — 80 each

** Main Turret — 180

Mini-Missile Launchers (2, sides) — 50 each

RG-Gun cupola (front) — 100

Reinforced Pilot's Compartment — 100

* Main Body — 380

Force Field — 200

* Depleting the M.D.C. of the main body destroys the vehicle, making it useless.

** Destroying the main turret prevents the use of all its weapon systems

Speed: 200 mph (320 km) maximum speed. Can travel over ground and water, and can lift up to 20 feet (6.1 m) off the surface. Its contragravity system allows the vehicle to float even higher, but every additional 6 feet (2 m) above 20 reduces maximum speed by 50 mph (80 km).

Statistical Data:

Height: 16 feet (5.4 m)

Width: 12 feet (4 m)

Length: 30 feet (10 m)

Weight: 18 tons fully loaded

Cargo: In addition to its troops, there are five 3 feet (0.9 m) by 3 feet compartments to store supplies and first-aid kits.

Power System: Anti-matter, average energy life of 50 years.

Market Cost: 55 million credits.

Weapon Systems

1. Laser Cannon: This is a high-intensity laser cannon able to penetrate heavy armor.

Primary Purpose: Anti-tank

Secondary Purpose: Defense

Mega-Damage: 2D6×10 M.D. per blast

Rate of Fire: Equal to the number of hand to hand attacks per melee.

Effective Range: 4000 feet (1220 m)

Payload: Effectively unlimited

2. Missile Launchers (2): Mounted on each side of the main gun are medium-range missiles used to engage targets at a distance or to shoot down incoming aircraft.

Primary Purpose: Anti-armor

Secondary Purpose: Anti-aircraft

Mega-Damage: Varies with missile type; usually issued plasma missiles (2D6×10 M.D.).

Rate of Fire: One at a time or in volleys of two, four, or eight.

Effective Range: About 40 miles (64 km)

Payload: 8 total; 4 per launcher.

3. Mini-Missile Launchers (2): These launchers are built on the sides of the main body and are used to engage enemy infantry, aircraft and missiles.

Primary Purpose: Anti-personnel, anti-aircraft

Secondary Purpose: Defense.

Mega-Damage: Varies with missile type. Usually carries a mix of fragmentation (5D6 M.D.) and plasma (1D6×10 M.D.).

Rate of Fire: One at a time or in volleys of two, four, eight or 16 missiles.

Effective Range: About one mile (1.6 km).

Payload: 32 total; 16 per missile launcher.

4. GR Gun: This gravity autocannon is located on a mini-turret in front and is usually operated by the tank commander. The gun is used to engage lightly armored targets and infantry, or to explode incoming missiles. The turret can rotate 360 degrees and has a 90 degree up and down arc of fire.

Primary Purpose: Anti-personnel

Secondary Purpose: Defense

Mega-Damage: 1D6×10 for a 10 round burst. Only fires bursts.

Rate of Fire: Equal to the number of combined hand to hand attacks.

Effective Range: 4000 feet (1220 m)

Payload: 2000 rounds; that's 200 bursts.

Dark Slayer Main Battle Tank (Transgalactic Empire)

The Dark Slayer is a heavy hover tank that uses standard air-cushion systems instead of a more effective (but expensive) contragravity generator. Its main weapon is a heavy laser cannon similar to weapons mounted on medium and light starships. Even in an atmosphere, the cannon has an effective line-of-sight range and, combined with advanced sensor systems, can engage high-flying aircraft or spacecraft entering the atmosphere. Its main purpose, however, is the same of most tanks through the ages, break and scatter infantry and destroy other tanks. The Dark Slayer performs both missions quite effectively.

This tank class is a veteran of the Consortium-Imperial War that occurred twenty years ago. In that conflict, it proved to be slightly inferior to the Phalanx tank used by the CAF (and devel-

oped by Wolfen engineers). The Dark Slayer is less expensive to produce, however, allowing the Transgalactic Empire to produce and deploy twice as many for half the cost of the CAF Phalanx. Numbers counted more than quality in a number of battles.

The tank is still in service and shows no sign of being phased out in the near future. It is often used for counter-insurgency missions in wilderness areas where the tank crews try to flush rebel guerrillas out in the open or to defend strategic positions. It is believed that some freedom fighter factions have captured several dozen Dark Slayers and are keeping them cached away until they can be used effectively. The Empire denies such rumors.

Model Type: IAF-95 MBT

Class: Main Battle Tank (hover)

Crew: Five; a commander, a pilot, a communications/sensor officer, and two gunners.

M.D.C. by Location:

Heavy Laser Cannon (1, in turret) — 180

Pulse Autocannon (1, in cupola over turret) — 80

** Main Turret — 320

Kinetic Rocket Cage (on back) — 150

Side-mounted Medium-Range Missile Launchers (2) — 120 each

Bow-mounted Laser Guns (2) — 80 each

*** Fan Skirts — 300

* Main Body — 650

Reinforced Crew Compartment — 150

* Depleting the M.D.C. of the main body destroys the vehicle.

** Destroying the main turret prevents the use of all turret weapons.

*** Destroying the fan skirts will destroy the hover system, grounding the vehicle and rendering it immobile. Field repairs will take at least 1D6 hours and there is a 01-50% chance that the tank will need major repairs. Hitting the fan skirts requires a called shot (no penalty).

Speed: 200 mph (320 km) maximum speed over land. Can hover up to 5 feet (1.5 m) above ground and travel without penalty over swamps and mud, but it is too heavy to hover above or on water.

Statistical Data:

Height: 21 feet (7 m)

Width: 24 m (8 m)

Length: 35 feet (7.9 m)

Weight: 180 tons

Cargo: Minimal storage facility for personal effects.

Power System: Nuclear; average energy life of 25 years.

Market Cost: 37 million credits.

Weapon Systems

1. Heavy Laser Cannon: This powerful weapon has great range and penetration. It is used almost exclusively against heavily armored targets. One of the two turret gunners operates this weapon.

Primary Purpose: Anti-armor

Secondary Purpose: Anti-aircraft and anti-personnel.

Mega-Damage: 3D6×10 M.D. per blast

Rate of Fire: Equal to combined number of hand to hand attacks per melee.

Effective Range: 3 miles (4.8 km)

Payload: Effectively unlimited.

2. Pulse Autocannon: This weapon is mounted on a cupola on top of the main turret. The second gunner sit in this turret and operates this weapon. The pulse cannon is often used against infantry, low-flying aircraft or flying power armor.

Primary Purpose: Anti-aircraft

Secondary Purpose: Defense and anti-personnel.

Mega-Damage: 6D6 M.D.

Rate of Fire: Equal to the combined number of hand to hand attacks.

Effective Range: 2000 feet (610 m)

Payload: Effectively unlimited.

3. Kinetic Rocket Cage: This “cage” holds 8 kinetic-kill rockets. These rockets use contragravity generators to fly at hypersonic speeds. Unlike normal rockets, they have no warheads; instead, they are solid metal, relying on their speed and density to rupture armor. Kinetic rockets move too fast to be guided, so they strike like normal cannon or energy blasts and do not use the special missile rules found in the **Rifts** rule book. The rockets can engage ground and air targets.

Primary Purpose: Anti-armor.

Secondary Purpose: Anti-aircraft.

Mega-Damage: 2D6×10 per rocket. The rockets can be fired in volleys of two or four (one dodge roll is made to determine whether all the rockets hit or miss).

Rate of Fire: One at a time or in volleys of two or four.

Effective Range: 4000 feet (1220 m)

Payload: 8 rockets total.

4. Side-Mounted Medium-Range Missile Launchers (2): These missile launchers are used for long-range attacks.

Primary Purpose: Anti-armor and anti-aircraft.

Secondary Purpose: Defense

Mega-Damage: Varies with missile type. Commonly issued plasma missiles (2D6×10 M.D.)

Rate of Fire: One at a time or in volleys of two, four, eight or sixteen.

Effective Range: About 40 miles (64 km).

Payload: 16 total; 8 per launcher.

5. Bow-mounted Laser Guns (2): These are light lasers used by either the pilot or commander as anti-personnel or anti-missile weapons.

Primary Purpose: Anti-personnel

Secondary Purpose: Defense

Mega-Damage: 2D6 per single blast or 4D6 M.D. per dual blast.

Rate of Fire: Equal to combined number of hand to hand attacks per melee.

Effective Range: 2000 feet (610 m)

Payload: Effectively unlimited.

Kartuhm-Terek

“The Doomsday Machine” (TE)

The largest military land vehicle in the Three Galaxies is the dreaded Kartuhm-Terek, named after a mythological Doomsday Machine of Kreeghor legend. This super-tank is as tall as a small building and several times more massive than the largest of the

heavy tanks. A contragravity system is necessary to keep it floating a few inches off the ground, which is the best the contragravity system can do, except for brief periods where it can increase altitude. A turbine system propels the Machine at good speeds, easily keeping up with lighter vehicles. The front has a wedge-shape, and is used to ram and smash through obstacles like trees, blockades, houses and small hills. Its multiple turrets give it the appearance of a mini-battleship. In terms of firepower, the Kartuhm-Terek is comparable to a spaceship rather than a land vehicle, packing more punch than a company of main battle tanks and an artillery battery combined. Plus it has enough armor and force fields to survive even a starship's main gun, although not for long. Its twin laser main guns can actually pluck out targets 60,000 feet above the Earth.

The Transgalactic Empire's Doomsday Machine has multiple redundant systems, including three power plants, contragravity and propulsion systems. To stop it, enemies have to literally blow it to smithereens. Its size is a drawback, making it easy to hit even from long distances. However, hitting it and significantly damaging it are two different matters. When the Transgalactic Empire is trying to conquer a planet, the first thing they do is deploy a tank division spearheaded by a single Doomsday Machine. Often, the sight of this devastating behemoth is demoralizing enough to cause a rout among the enemy troops.

Model Type: KT-1 (Transgalactic Empire)

Class: Strategic Super-heavy Armored Vehicle

Crew: Fourteen; one pilot, one co-pilot, two sensor officers, one communication officer, and nine gunners. Can carry up to 20 Kreeghor-sized passengers; the rest of the ship is dedicated to layers of armor and redundant systems.

M.D.C. by Location:

Laser Cannons (2) — 350 each

Heavy Missile Launchers (4, 2 in front, 2 in back) — 250 each

Gravity Cannon Turrets (2) — 200 each

Auto-loading Mortars (2) — 150 each

Medium Missile Launchers (4, on sides) — 100 each

Laser Batteries (4) — 100 each

Mini-Missile Launchers (4, one on each side) — 80 each

Reinforced Gunner's Compartments (9) — 100 each

Reinforced Pilots Compartment (1) — 200

Entrance Hatches (3) — 150 each

** Main Body — 3,000

** Depleting the M.D.C. of the main body completely destroys the outer hull of the vehicle. Due to the multiple redundancy of all sensor and communication systems, the vehicle will be fully operable until it is utterly destroyed.

Speed:

Driving on the Ground: 80 mph (128 km) maximum. The Doomsday Machine hovers about one foot off the ground. Any obstacle weighing less than one ton will not significantly slow this vehicle (can literally plow through light vehicles and houses without slowing down!).

Flying: Not possible; contragrav generators may increase altitude temporarily, allowing the tank to traverse chasms at high speed, but no sustained flight is possible.

Altitude: Up to 300 feet for about an hour before overloading the contragravity systems.

Range: Effectively unlimited.

Statistical Data:

Height: 80 feet (24.4 m)

Width: 50 feet (15.2 m)

Length: 120 feet (36.5 m)

Weight: 10,000 tons

Cargo: Minimal storage space for personal belongings of the crew (small locker for each crew member), plus a weapons locker with 20 rifles, 4 rocket launchers and 4 reloads for each).

Power System: Anti-matter; average energy life of 25 years.

Market Cost: The Kartuhm-Terek has a production cost of 420 million credits. No Kartuhm-Terek has been captured intact; its value on the black market could reach a billion credits or more!

Weapon Systems

1. Laser Cannons (2): These guns are the equivalent of starship level weapons, mounted on two gimbal turrets, located in the front of the vehicle. These guns will give "one shot one kill" results against most land vehicles or robots. The guns are surrounded by sensor antennas and receptors that allow them to track any "airborne" targets and space targets (sensor range 5,000 miles).

Primary Purpose: Anti-armor and anti-aircraft

Secondary Purpose: Anti-spaceship

Mega-Damage: 1D6×100 M.D. per single blast or 2D6×100 M.D. per double blast!

Rate of Fire: Each gun can fire once per melee.

Effective Range: If used against targets in space, it has a range of 2,000 miles (3,200 km). Against targets in an atmosphere, range is "only" 60,000 feet (18,288 m), roughly 11 miles!

Payload: Effectively unlimited.

2. Heavy Missile Launchers (4): These missile turrets are used to engage targets at long range. Inside the huge vehicle is a large missile magazine, allowing it to inflict massive bombardment.

Primary Purpose: Anti-armor, anti-installation.

Secondary Purpose: Defense, anti-personnel.

Mega-Damage: Varies with missile type. Commonly uses proton torpedoes or nuclear multi-warheads (4D6×10 M.D.). The missile magazine also has a limited number of fragmentation missiles for use against infantry (3D4×10 M.D.).

Rate of Fire: Each launcher can fire volleys of 2, 4 or 8 missiles; all four firing at the same target can put an awesome 32 missiles in the air in one attack.

Effective Range: About 500 miles (800 km).

Payload: 96 total. Each launcher has 8 missiles, plus they can auto-load from a missile magazine containing 64 additional missiles.

3. Gravity Cannons (2): These "light" artillery pieces are heavy enough to be the main gun of a normal tank.

Primary Purpose: Anti-Armor

Secondary Purpose: Defense

Mega-Damage: 3D6×10 M.D. per shot.

Rate of Fire: Equal to the number of combined hand to hand attacks per melee.

Effective Range: 6000 feet (1828 m)

Payload: 60 shots per gun.

4. Auto-loading Mortars (2): Mounted on the top of the Doomsday Machine are two mortars used to attack infantry

or armor hiding behind cover, fortification walls, and other obstacles. These weapons make ambushing the vehicle suicidal, because a few seconds after the ambush starts, the mortars will saturate the ambush area with explosive rounds. The automatic mortars fire smart mortar rounds that can alter their course to hit a target within 200 feet (61 m) of their landing spot. The load is a combination of armor piercing and fragmentary rounds to deal with both infantry and vehicles.

Primary Purpose: Anti-personnel

Secondary Purpose: Anti-armor

Mega-Damage: Fragmentary rounds do 1D4×10 M.D. to a 50 ft (15.2 m) blast diameter. Anti-armor rounds do 2D4×10 M.D. to a 10 ft (3 m) area.

Rate of Fire: Single shots or bursts of 10 rounds; each counts as one melee attack.

Effective Range: Two miles (3.2 km)

Payload: 600 rounds per mortar.

5. Medium Missile Launchers (4): The sides of the Kartuhm-Terek have four additional missile launchers for added firepower. When all its missile systems are fired, the tank's huge bulk is temporarily obscured by the flash and smoke of over 60 missile launches.

Primary Purpose: Anti-Armor

Secondary Purpose: Defense

Mega-Damage: Varies with missile type. Usually fires plasma missiles (2D6×10 M.D.)

Rate of Fire: One at a time or in volleys of two, four, or eight launchers, for a total of up to 32 missiles per melee round.

Effective Range: About 40 miles (64 km).

Payload: 152 total: Eight missiles per launcher plus missile magazine has an additional 120 missiles. Recycling missiles from the magazine to the launcher takes one melee round.

6. Laser Batteries (4): These are smaller laser turrets used for point defense or to engage enemy aircraft or infantry.

Primary Purpose: Anti-aircraft and anti-personnel.

Secondary Purpose: Defense

Mega-Damage: 1D6×10 M.D. per blast.

Rate of Fire: Equal to the number of combined hand to hand attacks per melee.

Effective Range: 2000 feet (610 m)

Payload: Effectively unlimited.

7. Mini-Missile Launchers (4): Finally, an additional four mini-missile launchers are located in strategic positions around the vehicle. These missile batteries are used almost exclusively against enemy missiles, or sometimes against infantry.

Primary Purpose: Defense

Secondary Purpose: Anti-personnel

Mega-Damage: Varies with missile type. Usually plasma (1D6×10 M.D.) missiles are used.

Rate of Fire: One at a time or in volleys of 2, 4, 8 or 12 per launcher.

Effective Range: About one mile (1.6 km).

Payload: 96 total; 24 missiles per launcher.

8. Ramming: The Doomsday Machine is very close to an irresistible force. When ramming any land vehicle or building the super-tank will inflict 3D6×10 M.D.+10 M.D. for every 20 mph (32 km of speed; if the other vehicle is traveling from the opposite direction toward the Machine, add the two speeds together). Robots, power armor and infantrymen who get in the path of the tank will be run down unless they dodge

(12 or higher). Being run down by the vehicle inflicts 2D6×10 M.D.!

Starships & Space

Space Skills (New)

Mechanical Skills

Spaceship Mechanics: The ability to repair, rebuild, modify and redesign conventional vehicles. This skill covers a basic understanding of gravitonic systems, but only includes the most rudimentary knowledge of phase technology, and no skills on Rift drives. Conventional ship systems (communications, hull, life support) are pretty much the same everywhere. **Base Skill:** 22% plus 5% per level of experience. Requires mechanical engineer skill and electrical engineering.

Physical Skills

Zero Gravity Movement & Combat: This skill allows a character to move with complete freedom, and work or fight without penalties in conditions of zero gravity, except that speed is reduced by 20%. The G.M. may, at his discretion, make players roll against this skill for difficult moves or combat. **Base Skill:** P.P. number x5% +4% per level of experience. **Note:** Characters who do not have this skill will have difficulty performing normal tasks in zero gravity. They move and fight with the following penalties: -15% on skill performance, -1 attack/action per melee, -2 on initiative, combat bonuses are reduced by half and speed is reduced by half.

Pilot Skills

EVA: Short for Extra-Vehicular Activity, this skill involves working outside a spacecraft while wearing a vacuum suit. The skill covers suit operation and repair, damage control, maneuvering and knowing what to do when things go wrong. A character should have Zero Gravity Movement to take this skill. **Base Skill:** 40% +5% per level of experience.

Pilot: Contragravity Pak: Similar to piloting a jet pack. **Base Skill:** 42% +4% per level of experience.

Pilot: Space Fighter: Typically one to three man fighter vehicles specific designed for fighter to fighter, fighter to power armor, fighter to ship, or fighter to robot space combat. These vessels engage in reconnaissance, military support, close combat, dog-fights, surgical strikes, and rescue missions. Some resemble atmospheric jet fighters or shuttle crafts (and may have transatmospheric capabilities) while others may look like rockets, geometric shapes or resemble animals (typically fish) and insects. **Base Skill:** 50% +3% per level of experience.

Pilot: Small Spacecraft: Typically cargo and shuttle crafts designed for short jaunts from planet to planet or space station. Some have interstellar capabilities, but most are comparatively slow transports intended for relatively short-range travel; typical speed is about half the speed of light. **Base Skill:** 60% +3% per level of experience.

Pilot: Starship: These are the BIG intergalactic vessels, massive cargo ships, ore haulers, transports, battleships and other immense ships, usually with a crew and/or passengers that number into the hundreds or even thousands. **Base Skill:** 36% +4% per level of experience.

Pilot Related Skills

Navigation - Space: Basically the same as normal navigation techniques. The only difference is the use of stars and some of the sensory equipment. More importantly, a failed roll will place the ship 4D6 light years off course! **Base Skill:** 40% +5% per level of experience.

Science

Astrophysics: Knowledge of stellar astronomy and how it relates to nuclear physics, quantum mechanics, relativity and other explanations for the creation of deep space phenomena, like quasars and black holes. Gravitonic drive systems require this skill to understand the principles under which they work. **Note:** Basic and advanced math are required before taking Astrophysics. **Base Skill:** 30% +5% per level of experience.

Xenology: The biological study of alien species. This skill provides general information about the most commonly encountered species in the Three Galaxies. Without Xenology, any attempts to use a medical skill on a creature from another species are at -20% to skill rolls. **Base Skill:** 30% +5% per level of experience.

Technical

Law: CCW: This skill covers the laws of the Consortium of Civilized Worlds, including the Civilization Compact. **Base Skill:** 30% +5% per level of experience.

Lore: Galactic/Alien: This skill helps characters identify known alien races, and provides information on their culture, habits, etc. Given the number of alien species in the Three Galaxies, it is very difficult to know every single recorded alien species without a computer database handy. It also includes most of the well known legends and speculations about the Cosmic Forge, cosmo-knights, kreeghor and prometheans. **Base Skill:** 25%+5% per level of experience. When dealing with less known alien species, G.M.s can assign a penalty from -5% to -30% at their discretion.

Note: Also see **Mutants in Orbit** (for *Rifts* and *TMNT*) for additional, optional skills.

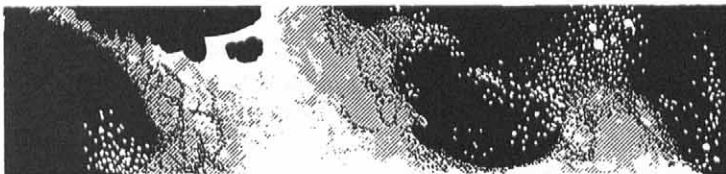

Fighters & Small Vessel Combat

Combat between space fighters and light vessels is played out in a manner similar to normal combat, with initiative, attack and dodge rolls, and damage. There are a number of new maneuvers that can only be used between space fighters, fighter jets, airplanes, and other small, fast vessels. These rules can also be used

for combat between flying robots and power armor. **Note:** Rules on large ship combat will be detailed in the **Phase World Sourcebook One: The Three Galaxies** (scheduled for an early 1995 release).

Dog-Fighting Maneuvers

Space and air combat really only has three possible states. Vehicles can be coming together for combat, jockeying for an advantage, or the vehicles are so far apart that no combat is possible. Each combat tactic takes one full melee to perform. The number of shots that can be fired depends on the character's attacks per melee.

The most common position in aerial combat is where one vehicle, the Dog Tail, is following another vehicle, the Dog.

Dog Tail

This is where every combat flyer wants to be. Sitting on the other guy's tail, where every melee round is an opportunity to shoot without being shot back at. Keeping on a *dog tail* means matching or beating the opponent's attempts to escape.

To become a dog tail, the player for each pilot rolls a 20 sided die, adding their dog-fighting bonus (including P.P. bonuses), and any ship movement bonuses. The faster or more maneuverable of the two vessels gets a +2 to the roll. The winner gets to be the *dog tail*. The loser is the *dog*. Depending on the situation, however, the G.M. can rule that a dog tail is automatically successful (if the attacker comes up from behind, out of a cloud, etc.).

The vehicle in the *dog tail* position can open fire with all available weapons, every melee round he is "on the dog" (the vehicle in front). The dog can only fire back if he has a tail gunner with backward-facing weapons. Most fighter weapons only face forward. Large ships usually have multiple gunners, with one or more able to fire backwards or in a circle. The *dog tail* can dodge attacks normally; the dog is at -3 to dodge!

Bonuses for Space Fighter Combat "Basic" Training

- One extra attack/action involving the fighter's weapon systems.
- +2 to strike (in addition to other cumulative bonuses).
- +3 to dodge attacks while flying.
- +1 to dog-fighting rolls
- Critical strike, same as pilot's hand to hand.
- One additional attack at level six.
- One additional attack at level eleven.

Bonuses for Fighter Combat "Elite" Combat Training

- Two extra attacks/actions involving the fighter's weapon systems.
- +2 to strike (cumulative with bonuses from Weapon System skill training).
- +5 to dodge attacks while flying.
- +3 to dog-fighting rolls.
- Critical strike, same as pilot's hand to hand.
- One additional attack at level five.
- One additional attack at level ten.

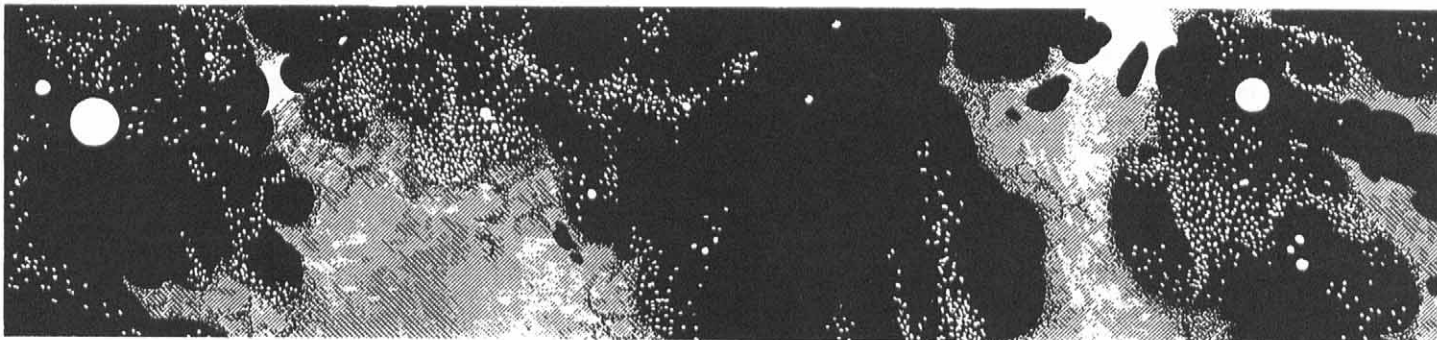

FTL Propulsion

The main obstacle to spacefaring races is breaking the so-called Light Barrier, the seeming impossibility to travel faster than the speed of light. Without transcending light speed, travel between planets would take centuries or even millennia. The civilizations of the Three Galaxies have discovered three different systems to break the light barrier: *phase drives*, *gravitonic drives*, and *Rift drives*. Other cultures of the Megaverse have developed *space-fold drives*, but this system has a lot of risks. For reasons unknown, space-fold drives are very likely to malfunction in the Three Galaxies. Some blame the Cosmic Forge for it. Others think that the strong presence of magic and ley lines even in empty space may somehow disrupt those systems.

Phase Drives (P-Drives)

P-Drives are very common among vessels used by civilians and independent worlds. They use phase-tech to envelop the ship in a phase field that partially removes it from physical reality and the limitations of normal speed. Even normal propulsion systems can accelerate the ship hundreds of times the speed of light when it is in "phase." The average P-drive has a speed of one light year per hour. Ships using the most powerful thrusters combined with a P-drive can reach a speed of 10 light years per hour.

There are several limiting factors: One, the maintenance of P-drives remains a mystery to everybody other than the *promethean* race. It seems that some of the components of the engine are not even in our physical reality! Although P-drives are very sturdy, if they break down, only the most basic repairs can be done by anybody other than a *promethean* technician. Repairs are usually done by replacing modular components with new ones. Most ships have enough spare modules to build two or three whole p-drives! If the ship runs out of modular parts, and it doesn't have a *promethean* technician on board (or near by), it is out of luck.

Two, P-drives can only safely function for up to 12 standard hours at a time. After this point, the ship's guidance system must be recelebrated, a process that takes 1D6+6 hours. For every hour of uninterrupted travel beyond 12 hours, there is a cumulative 10% chance that the ship will veer off course and end up 3D6×1000 light years away from its intended destination.

Third, P-Drives cannot operate in an atmosphere, or even close to a planet's atmosphere. If a P-drive is not disengaged before a ship is between 10 and 20 thousand miles (16,000 to 32,000 km) away from a planet, there is a 70% chance that the ship will plunge into the planet's atmosphere. The FTL phased ship will hit the atmosphere like a solid wall, with enough force

to splatter it like a bug on a windshield. Even a miles-long dreadnought will be consumed in a nasty fireball from such an impact!

Contra-Gravitonic Drives (CG-Drives)

Most spacefaring civilizations of the Phase World universe use gravitonic technology for transportation, as well as for some weapon systems. Gravitons are sub-atomic particles that travel in waves. The interaction of those particles determines the forces of gravity. The scientists of many cultures (the discovery is relatively easy to make once a civilization reaches the right technological level) realized that opposing graviton waves could be canceled out, thereby nullifying the effects of gravity over a given object. The discovery that followed this realization was even more important. If an object was freed from the bonds of gravity, it was also no longer limited to the speed of light. A ship enveloped in a contra-graviton field (commonly known as a CG-field) could theoretically reach any speed imaginable.

In practical terms, however, most CG-drive starships have reached a roof of about eight light year per hour (about 70,000 times the speed of light!). CG-drives, like phase drives, have to be disengaged when approaching a planet. The safest distance a ship can travel at Faster Than Light (FTL) speeds is 10,000 miles (16,000 km) away from a planet (twice that is safer).

The CG-drive has been the cornerstone of spaceflight in the Three Galaxies. The only two other FTL systems are phase-drives and Rift-drives. Phase-tech is rare and expensive, and Rift-jumping is dangerous, so neither system is as popular as this one.

Rift Jump Drives (R-Drives or Magic/M-Drives)

The Three Galaxies contain several advanced civilizations that rely on magic for space travel. They have devised a techno-wizard "Rift Drive" or "Rift Jump Drive." The Rift jump drive opens two Rifts, one at the ship's current location and another at its destination. The ship then travels through a dimension of swirling lights and colors, called the **Flux Dimension**, and emerges through the other Rift, light years away. The P.P.E. cost of the Rift creation is great and R-Drive ships require P.P.E. batteries with great bulk, and/or the services of a powerful magician. Close proximity to any planet disrupts the complicated calculations that are necessary to chart the jump, so the ships have to make the jump somewhere away from a planet's main gravity and ley line fields, usually between five and fifty thousand miles away, depending on the size of the planet. The first Rift ships were crude rocket devices that carried the travelers into high orbits before allowing the drive to kick in. Current models combine standard technology with techno-wizardry.

Rift drives (and the P.P.E. batteries they need) are too big for small ships like fighters and light vessels. The smallest vessels that can be equipped with an R-Drive are medium transports and frigates. Small ships can ride piggy-back on a large, Rift driven ship, but there is a 10% chance of falling off and getting stuck in the Flux Dimension; roll once for each hour of travel.

Spacegate Jump Systems

This system uses phase technology to instantly transport a ship to one of the spacegates built around Phase World. It is not actually a FTL system, or any type of propulsion system of any kind. It is a phase-tech device that, when activated, will “pop” the ship from anywhere in the universe (not other dimensions) through one of the 64 “spacegates” in orbit around Phase World. It is in effect, a cosmic homing device that instantly teleports the ship, crew and cargo to Phase World. A spacegate is a huge ring that’s typically 10 miles (16 km) in diameter. There are some serious limitations to this method of travel. First, the promethean technicians who monitor the spacegates can scan the ship before it pops through and deny access if they detect or suspect trouble or danger (or any reason). Secondly, it’s a one-way trip to Phase World. The jump can cover any distance instantly, but it only works *one way*, thus a ship will need to have an alternative means of propulsion to leave the planet. Most ships that have a Spacegate Jump System are merchants and transports who travel to Phase World frequently. See the section on **Phase World** for more information about *spacegates*.

Sublight Propulsion Systems

None of the drive systems described above is useful to maneuver between planets, since they must be disengaged some distance away from them (see above). A number of systems have been developed to propel the ship in “normal space” below light-speed.

Contragravity Drive

Gravitonic technology also provides most of the thrust systems used by both sublight spaceships and conventional aircraft. The same technology that neutralizes the pull of gravity can also generate acceleration in conventional vehicles. Contragravity “thrusters” generate speeds of up to Mach 8 in an atmosphere, and up to Mach 25 in empty space (25 times the speed of sound). In an atmosphere maximum speed typically ranges from Mach 4 to Mach 10 (approximately, 2,640 to 6,600 mph/4,200 to 10,600 km). In an emergency, a ship can push the envelope and accelerate to up to 3 times normal maximum speed, but these bursts of speed can only be maintained for 1D6 hours, and the ship risks being unable to decelerate (remember that in near-empty space, ships retain their momentum) without damaging themselves. There’s an 18% chance of burning out the propulsion system (making maximum speed Mach 2 in space), or causing 2D4×100 M.D. to the structure of the ship, and they may overshoot their destination by 2D6×1000 miles. Furthermore, maneuvering at these speeds, i.e., doing anything other than traveling in a straight line, is very difficult: -4 to dodge and the performance of special moves is -25% (dog-fights are impossible).

80% of the ships built and flown in the CCW, the Transgalactic Empire, and most other spacefaring civilizations use contra-gravity drives. Unless specified otherwise, all the ships in this section have that system of propulsion, with FTL drives optional.

Other Propulsion Systems

Other propulsion systems include chemical, ion, plasma, solar and traction drives, all of which are described in the **Mutants in Orbit** supplement. They represent the other 20% of ships found in the Three Galaxies.

Sensor Systems

Unless indicated otherwise, all starships have these sensor systems. Military ships have more sophisticated sensors, so add +10% to all sensor operation rolls and ranges.

Radar, sonar, radiation, thermographic, motion and gravity-wave sensors which can detect ships as far away as 200,000 miles (322,000 km) — if they are in normal space. Ships using a gravity or P-Drive make disturbances in the normal space-time continuum which can be detected from as far as one light year! Military systems can detect FTL ships at up to 10 light years away. “Stealth” systems reduce the ship’s radar signature, so that they can remain undetected until they are 5,000 miles away (8,000 km), at which time they can be detected through visual scans.

Spaceship Weapon Systems

Described below are some typical ship weapon systems used in the Three Galaxies. Individual ships may have differences in terms of damage or range due to customization. These weapons are sometimes used in huge military land or sea vehicles, and truly giant robots (40+ feet/12.2+ m).

Remember that range in space is dramatically farther than in an atmosphere or underwater. Short range in space is one mile (1.6 km)!

Point Defense Lasers

These are “mini”-lasers used primarily to engage missiles, space fighters, robots and power armor at very close range (within a mile/1.6 km of the ship). They don’t do enough damage to seriously threaten most large ships and are considered defensive weapons. Most civilian ships mount at least one or two point-defense lasers as a secondary weapons system. Military ships may have several dozen on multi-barreled turrets, that are able to pack a nasty punch against fighters, robots and small vehicles.

Weight: Less than one ton (less than 900 kg).

Mega-Damage: Available models by damage: 3D6 M.D. (the lightest model available), 4D6, 5D6, 6D6, 1D4×10, and 1D6×10 per barrel. Multi-barreled or pulse-lasers can do as much as 3D6×10 M.D. per triple pulse/blast. The average defense laser in civilian ships does 4D6 to 1D4×10 M.D.

Rate of Fire: Equal to the total number of hand to hand attacks of the gunner.

Effective Range: Between 2000 feet (600 m) and 12,000 feet (3600 m), a bit over 2 miles (3.2 km).

Payload: Effectively unlimited. These guns are usually connected to the ship's main power.

Cost: 50,000 to 500,000 credits each.

HI-Laser Cannon (Light)

Typically mounted on fighters as a light assault weapons or on medium spaceships as secondary guns. This cannon is much heavier and more powerful than most land-mounted weapons, except in the largest tanks or robots. It is also typically the heaviest weapon found in civilian starships.

Weight: 1/2 ton (453 kg) per barrel, or 1 ton (907 kg) per barrel if mounted in an armored turret.

Mega-Damage: Varies: 1D4×10. M.D., 1D6×10, 2D4×10 or 2D6×10 M.D. per blast. Multi-barreled laser systems (typically two barrels; mounted on large spaceships, not fighters) can do double damage per simultaneous double-barrel blast.

Rate of Fire: Equal to the total number of hand to hand attacks of the gunner.

Effective Range: One to three miles in space (1.6 to 4.8 km). Usually half or less in an atmosphere.

Payload: Effectively unlimited when tied to a nuclear or anti-matter power plant. Many ships put a power plant on each weapons turret to keep the gun working even if central power is lost. Doing this adds one million credits to cost and a 1/2 ton (453 kg) to the weight.

Cost: Four to eight million credits each, depending on where it is being purchased and damage capabilities. Additional optics, sensors and targeting systems are all extra costs.

HI-Laser Cannon (Medium)

This is either a light ship's main gun or a medium to large ship's secondary gun. Some ships carry two to four medium HI-laser cannons mounted on a turret, and are able to fire all of them at once against the same target for maximum damage.

HI-Lasers are only found in military or pirate vessels; the authorities of most spaceports will have many questions for any "civilian" ship armed with such ordnance.

Weight: 2.5 tons (2270 kg) per barrel, or 5 tons (4530 kg) per barrel mounted in an armored turret, plus a 2-ton (1800 kg) power plant (nuclear or antimatter).

Mega-Damage: Varies: 1D4×100, 1D6×100, 2D4×100, or 2D6×100 per turret. These guns do not have multiple-pulse capabilities, but simultaneous double, triple or quadruple blasts from several turrets firing at the same target can be accomplished by linking the turrets to key on one target.

Rate of Fire: Equal to the total number of hand to hand attacks of the gunner.

Effective Range: 5 miles in an atmosphere but 16 miles in space (8 to 25 km).

Payload: Effectively unlimited. Always has a dedicated nuclear or anti-matter power plant to prevent the risk of overloading the main power source, and to fight on even if the main power is lost.

Cost: A medium laser turret costs 80 million credits, sometimes more than the cost of entire ships! Additional optics, sensors and targeting systems are all extra costs.

HI-Laser Cannon (Heavy)

These are giant cannons that weigh several tons and are mounted on the largest ships; cruisers, battleships or dreadnoughts. Most cruisers will only have one or two heavy cannons, usually aiming forward. Battleships and dreadnoughts may have several turrets with two to four cannons each, that can vaporize a vessel in one searing volley. Any ship with a heavy laser cannon is a military/warship, and treated as such by the authorities at most spaceports.

Weight: 8 tons (7,300 kg) per cannon, or up to 16 tons (14,500 kg) per barrel if in an armored turret.

Mega-Damage: 1D4×1000 or 1D6×1000 per barrel! Multiple barrel turrets can do between 2D4×1000 to 4D6×1000 M.D. per simultaneous blast of all barrels at the same target.

Rate of Fire: All turret barrels/cannons can fire in one devastating, simultaneous blast which counts as one melee attack, but can only be fired in such a manner twice per melee round; or each individual cannon/barrel can be fired one at a time up to the number of hand to hand attacks per melee of the gunner.

Effective Range: 16 miles in an atmosphere or 100 miles in space (25 to 160 km).

Payload: Effectively unlimited. Always has a dedicated nuclear or anti-matter power plant to prevent the risk of overloading the main power source and to fight on even if the main power is lost.

Cost: 180 million to 220 million credits. Additional optics, sensors and targeting systems are all extra costs.

Particle Beam Cannon (light and medium)

Particle beam weapons have shorter ranges than lasers, but are more powerful than equivalent laser weapons. There are so many different particle beam weapons of different sizes and firepower that the line between point-defense, light and medium particle beam weapons is blurred.

Weight: From 600 lbs to 1 ton (270 to 907 kg). Doubled if mounted in an armored turret.

Mega-Damage: Varies per barrel/weapon. The lightest point-defense particle beam weapons do 1D4×10 or 1D6×10 M.D. per single blast, light 2D6×10 M.D., medium 1D4×100 M.D. or 2D4×100 M.D. per blast. Double or triple barrel turrets do double or triple damage when all the barrels are fired simultaneously at the same target.

Rate of Fire: Equal to the total number of hand to hand attacks of the gunner.

Effective Range: One to four miles (1.6 to 6.4 km) in space, one-third that range in an atmosphere.

Payload: Effectively unlimited if connected to a ship's power plant. Some weapon turrets have an integral power plant.

Cost: One to four million credits per barrel/cannon for light weapons and 20 to 35 million for medium; turret (add 30 million), additional optics, sensors and targeting systems are all extra costs.

Particle Beam Cannon (heavy)

Like the heavy laser cannon, this is a main weapon used in medium to large military vessels.

Weight: 1 to 8 tons (907 to 7300 kg) per cannon, doubled if turret-mounted.

Mega-Damage: Varies: 3D6×100, 1D4×1000 or 1D6×1000

M.D. per blast. Multiple-cannon turret volleys inflict up to 4D6×1000 M.D. per blast!

Rate of Fire: Equal to the total number of hand to hand attacks of the gunner.

Effective Range: 6 miles in an atmosphere or 70 miles in space (9.6 to 112 km).

Payload: Effectively unlimited.

Cost: 140 million to 200 million credits. Additional optics, sensors and targeting systems are all extra costs.

PC-50 Light Phase Cannon

All phase weapons use phase technology to harm living things, and to negate force fields without damaging the surrounding armor and machinery. See the section on energy hand-guns for the complete description of how this works.

Weight: 250 lbs. (113 kg)

Mega-Damage: 3D6 to all living targets in a 30 ft (9.1 m) diameter around the blast point or 1D6×10 to force fields and creatures 10 feet (3.0 m) or larger. This damage is S.D.C. to non-M.D.C. creatures, or M.D. to M.D.C. creatures or force fields.

Rate of Fire: Equal to the total number of hand to hand attacks.

Effective Range: 4000 feet (1200 m)

Payload: 100 shots from an Energy-pack, or unlimited if connected to the ship's power plant.

Cost: 500,000 credits

PC-100 Phase Cannon

Weight: Half a ton (453 kg).

Mega-Damage: 3D6 to all living targets in a 30 ft (9.1 m) diameter around the blast point or 1D6×10 to force fields and creatures 10 feet (3.0 m) or larger. This damage is S.D.C. to non-M.D.C. creatures and M.D. to M.D.C. creatures and force fields.

Rate of Fire: Equal to the total number of hand to hand attacks.

Effective Range: 10,000 feet (3,000 m)

Payload: 100 shots from an E-pack, or unlimited if connected to vehicle's power plant.

Cost: One million credits

PC-200 Heavy Phase Cannon

The PC-200 is most commonly used by starships or as the main armament of light or medium fighter craft and some tanks.

Weight: 2 tons (1800 kg).

Mega-Damage: 4D6 to all targets in a 50 ft (15.2 m), or 6D6 to any creature 10 feet (3.0 m) or taller or a force field. This damage is S.D.C. to non-M.D.C. creatures and M.D. to M.D.C. creatures and force fields.

Rate of Fire: Equal to the total number of hand to hand attacks.

Effective Range: 2 miles (3.2 km).

Payload: 200 shots from an E-pack or unlimited if connected to vehicle's power plant.

Cost: Four million credits.

GR-100 Light Autocannon

A gravity gun mounted on fighters, heavy aircraft, APCs, light tanks and some anti-missile weapon turrets. A rifle model can also be wielded by a giant robot.

Weight: 1 ton (907 kg).

Mega-Damage: 1D6×10 for a 10-round burst. Only fires bursts.

Rate of Fire: Equal to the number of combined hand to hand attacks.

Effective Range: 3 miles (4.8 km) in space, 6,000 feet (1800 km) in an atmosphere.

Payload: 10,000 rounds (1000 bursts)

Cost: 600,000 credits.

GR-1000 Autocannon

This is often used as the main gun of fighters, or as a defensive system of non-military vessels. It has enough range to be useful in space combat

Weight: 2 tons (1800 kg)

Mega-Damage: A burst is 20 rounds and does 4D6×10 M.D. Can only fire bursts.

Rate of Fire: Equal to the total number of hand to hand attacks of the gunner.

Effective Range: 16 miles (25 km) in space, one-third that amount in an atmosphere.

Payload: Varies. 10,000 rounds (500 bursts) would weigh a ton (907 kg).

Cost: 8 million credits

Missiles

All missiles described in **Rifts**, page 46, are used on starships. Mini-missiles and short-range missiles are used mostly for point-defense, while medium and long-range missiles are used against other ships. Another type of missile, the *cruise missile*, is a super-heavy missile that inflicts 2D6×100 (nuclear) or 4D6×100 M.D. (anti-matter). It has a range of 1000 miles (1600 km).

Rift Projector Cannon (UWW)

This fearsome weapon is mounted on the largest wizard-ships of the United Worlds of Warlock (UWW). Its "Rift" name is a misnomer, because rather than create a "normal" or "true" Rift (a dimensional doorway to another world), the RP-cannon creates a dimensional anomaly that damages and besieges the ship. The effects are unpredictable but disorienting, and often highly destructive.

As with other Rift-based technology, it is potentially dangerous to the user. Every shot fired by an RP-cannon has a 0.5% cumulative chance (i.e., becomes 1% after two shots, 2% after four shots, and so on) of backfiring and damaging the ship that launched them! The weapon is shaped like an 80 inch (200 cm), relatively stubby ("only" 60 feet/18.3 m long) cannon, that usually mounted on the front end of the ship.

Weight: 200 tons (180 metric tons).

Mega-Damage: The effects of this weapon are unpredictable and varies dramatically. Roll on the Rift Cannon Damage Table that follows. If the damage rolled is enough to destroy the ship, don't bother rolling on the Rift Effect Table (except for dramatic purposes). Note that some of the effects negate/prevent any damage.

Rate of Fire: Can fire once per minute (4 melee rounds/60 seconds).

Effective Range: 50 miles (80 km)

Payload: Requires 1,000 P.P.E. per shot.

Cost: 500 million credits.

Rift Cannon Damage & Effect Table

- 01-10** 1D4×100 damage, no other effects.
11-20 1D6×100 damage, no other effects.
21-30 1D4×1000 damage, no other effects.
31-40 2D6×10 damage, roll on the Rift Effect Table.
41-50 4D6×10 damage, roll twice on the Rift Effect Table.
51-60 1D4×100 damage, roll on the Rift Effect Table.
61-70 1D6×100 damage, roll on the Rift Effect Table.
71-80 1D4×1000 damage, roll on the Rift Effect Table.
81-90 1D6×100 damage, roll twice on the Rift Effect Table.
91-00 1D4×1000 damage, roll twice on the Rift Effect Table.

Rift-Projector Effect Table

- 01-10** Thank the Cosmic Forge! No effect!!
11-15 Temporary power failure: The ship's entire weapon and propulsion system "stalls out" for 1D4 melee rounds, including back-up and sub-light systems. It cannot maneuver, change course, dodge, or fight but continues to coast forward at its previous speed and heading.
16-20 Plasma Cloud: The Rift releases a cloud of plasma from a star! The ship takes an additional 1D4×100 M.D. and all its sensor systems are blinded until it moves out of the cloud (takes one melee round). On the good side, the cloud will also act as cover for the ship: all attacks against it are at -4 to hit.
21-25 Force Field Failure: Any force fields or phase fields of the ship are shorted out for 1D6 melee rounds. Nothing can be done to bring them back on line any sooner.
26-30 Distortion Effect: Time seems to stop, everybody seems to move in slow motion as a score of strange images of different environments and realities appear and disappear in rapid succession (forest, desert, snow, underwater, clouds, hellish flames, etc.). The entire effect seems to last several minutes but only one melee round (15 seconds) has actually passed. During that time characters only get two melee actions/attacks and are -5 to strike, parry and dodge (no initiative). Furthermore, they are all struck by "existential nausea" from the waves of distorting realities that wash over them. All crew members must save vs magic or suffer the following penalties: -2 on initiative, -2 to strike, parry and dodge and -1 melee action/attack for 1D6 melee rounds.
31-40 Critters! 2D4×10 creatures/predators from another dimension are Rifted into the ship! Depending on the circumstances (and G.M.), they are angry and attack, or afraid, running rampant on the ship, wrecking equipment and causing a nuisance in their panicked state. They must be trapped and contained or destroyed. A typical critter has 6D6 M.D.C., and can bite, claw or pounce for 1D6 M.D. damage (+1 to strike and parry, +3 to dodge, two or three attacks per melee, climb 70%). Or the G.M. can design other minor menaces or bring in minor demons or entities.
41-50 Dimensional Whiplash: For a split second, the ship and its crew are flung through a Rift, but the second they reach the other side they are slung back, like a rubber band, into their own dimension! This has little effect on the ship, which is designed to withstand stress, but does the equivalent of whiplash damage to the crew as they are flung from one side of the ship to the other. Take 4D6 S.D.C. damage and lose half their melee actions for that round. The ship's gunners are at -2 to strike, parry and initiative for the next melee round.

51-60 Rift Jump: The ship is sucked into a Rift and teleported 1D6×100 miles in a random direction! Enemies may think the ship has been destroyed, at least until they relocate it on their sensors.

61-70 FTL is Gone! The ship suffers absolutely no structural damage but all FTL systems and artificial gravity systems disappear! Rifted to another dimension! Crew members have to make rolls against their Movement: Zero Gee skill to continue fulfilling their duties, and the ship may be without propulsion unless it has a secondary sub-light systems!

71-80 Dimensional Displacement: The vessel is Rifted into an alien dimension, galaxy or reality! The effect is temporary and can last a few minutes, hours or days (G.M.'s discretion). While in this alien place, the characters may encounter, or battle with the beings who live there. However, at some point the effect of the displacement slings the vessel and its crew back to their own dimension at the exact location where they were hit. However, in this case the tidal waves of the jump affect the ship's superstructure, inflicting 1D6×100 M.D. to the ship.

81-85 Minor Time Jump: The ship disappears from the battle and reappears, undamaged, 2D6 minutes later in the exact same spot as before (may crash into another vessel that has moved to its old location, inflicting 1D6×100 M.D.C.).

86-90 A ley line storm inside the ship: Standard ley line storm effects. Lasts 1D6 melee rounds. People, property and computer systems may suffer damage.

91-95 Super charged! The ship takes an additional 2D6×100 M.D.C. and the crew suffers 2D6 S.D.C. damage, however all energy systems are super charged! All energy weapons do double damage (same range), force fields are replenished and have 50% more M.D.C. and magic weapons and spells do triple damage! Unfortunately, this super state only lasts 1D4 melee rounds. When the effect ends, the ship reverts back to normal, damage and all.

96-00 Major Time Jump: The ship disappears from the battle and reappears, undamaged, 2D6 days later! Reappears in the exact same spot as before (may crash into another vessel that has moved to its old location, inflicting 1D6×100 M.D.C.).

Variable Force Fields

Many space ships do not rely on their armor alone. Military and large spacecrafts have force field generators to supplement their armor. They are useful not only against enemy attacks, but against radiation, atmospheric re-entry heating, meteor storms and other dangers. Small commercial ships have a simple, full force field that protects the entire vessel with the same M.D.C. value. Military and large ships can manipulate the "density" of the *variable force field* over specific parts of the ships. This results in six different shield values, one each for the front, back, left and right side, top and bottom. All six sides have the same basic M.D.C. value, but they can shift M.D.C. points from one location to the next, or put the total M.D.C. points on one location! Damage on the force fields is subtracted on each side separately.

Example of Variable Force Fields: A ship with a force field of 1,000 M.D.C. per section (6000 total) can vary shield density from one location to another. It could shift 500 M.D.C. from the back to raise the M.D.C. of the front to 1,500, or even put all shield power on the front for 6,000 M.D.C. of protection, and

zero on the rest of the ship. Or, if the left side has been depleted by 300 points due to an attack, the ship could replace the 300 by taking it from the other side, and so on. Remember, for space and air vehicles there are *six* sides, front, back, right side, left side, top and bottom.

Space Fighters

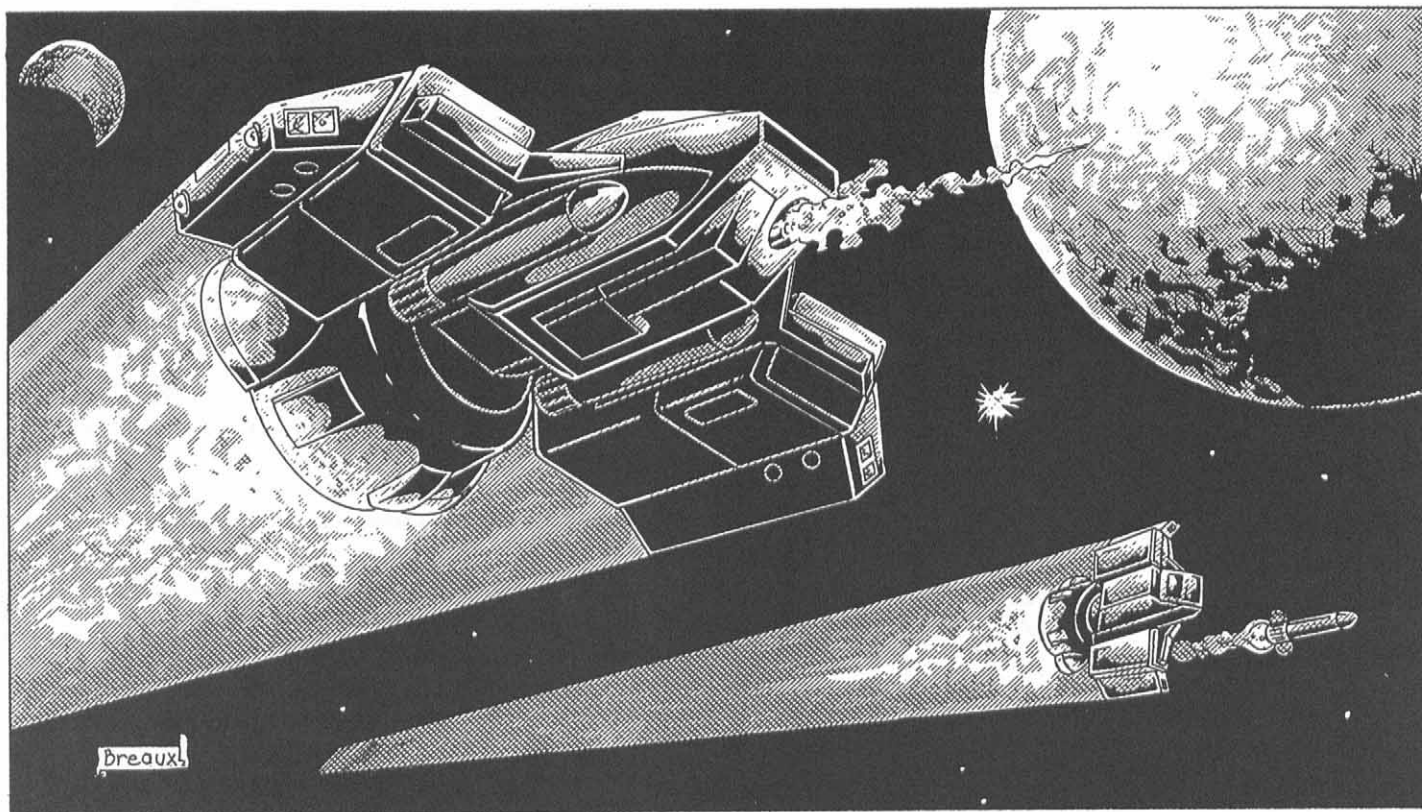

Scorpion-Class Light Fighter (CAF)

Designed to operate from carrier ships like the Pack Master, the Scorpion is a small and fast space fighter. Its purpose is to engage enemy fighters and short-range vessels, protect the larger ships of the fleet and support heavy fighters and combat robots like the Silverhawk in both offensive and defensive operations. The Scorpion is one of the fastest sublight fighters in the CCW's armed forces and is extremely maneuverable. Its drawbacks are its light armor and lack of a force field, which make it relatively vulnerable to other fighters. As Scorpion pilots are fond of saying, however, "You have to hit 'em to hurt 'em" and the Scorpion is notoriously hard to hit, and packs quite a sting.

The Scorpion is a true space fighter. Its lines are not truly aerodynamic, which is not important in the vacuum of space. In atmospheric conditions, however, the ship is much slower and maneuvers like a brick. Due to this, Scorpions are meant to operate only in space, and are assigned to large ships, space stations, and similar bases.

Model Type: SF-69, or SF-69B

Class: Light Interceptor or Fighter-Bomber (SF-69B)

Crew: One

M.D.C. by Location:

Nose GR Cannon — 40

Wings/Missile Launchers (2) — 150 each

Cruise Missiles (CCW69B only; 2 in underbelly) — 60 each

* Auxiliary Engine — 150

Reinforced Pilot's Compartment/Escape Pod — 110

** Main Body — 550

** If all the M.D.C. of the main body is depleted, the vehicle is destroyed. The pilot's only hope is to eject (the reinforced pilot's compartment becomes an escape pod with 48 hours' worth of oxygen).

* If the auxiliary engine is destroyed, the ship's top speed is reduced to Mach 8.

Speed: In space: Mach 8, or an amazing Mach 18 with the auxiliary engine thruster. In an atmosphere, maximum speed is Mach 3. The SF-69B has the same performance in space, but can only fly at Mach 2 in an atmosphere (the missiles add to air drag).

Bonuses: +2 on initiative, +1 to strike, +4 to dodge, and +10% on dog-fighting and special maneuvers!

Range: Effectively unlimited; limited only by the pilot's endurance and oxygen supply (life support will last 12 days).

Statistical Data:

Height: 10 feet (3.0 m)

Width: 31 feet (9.5 m)

Length: 34 feet (10.4 m)

Weight: 6 tons/5400 kg (7 tons/6350 kg for the SF-69B).

Cargo: Small utility closet with room for a small sidearm, dry rations for 12 days, and a water dispenser.

Power System: Antimatter, average energy life of 25 years.

Market Cost: 30 million credits (50 for the SF-69B).

Weapon Systems

1. GR Cannon: The main weapon of the Scorpion is a medium gravity rail gun used to destroy enemy fighters, and to strafe larger ships or ground targets.

Primary Purpose: Anti-spacecraft

Secondary Purpose: Assault

Mega-Damage: 4D6×10 M.D. per 20 round burst. Can only fire bursts.

Rate of Fire: Equal to the total number of hand to hand attacks of the pilot.

Effective Range: 16 miles (25 km) in space, half that amount in an atmosphere.

Payload: 10,000 rounds (500 bursts)

2. Missile Launchers (2): Each “wing” is a mini-missile launcher. Used for dogfights against enemy fighters.

Primary Purpose: Anti-spacecraft

Secondary Purpose: Defense

Mega-Damage: Varies with missile type. Commonly use plasma (1D6×10 M.D.)

Rate of Fire: One at a time or volleys of 2, 4 or 8.

Effective Range: About two miles (3.2 km).

Payload: 32, 16 on each wing.

3. Cruise Missiles (2): The SF-69B also carries two cruise missiles with the power to destroy, or severely damage a starship or ravage ground targets. This weapon is not designed for anti-fighter warfare and enemy fighters and robot-sized targets have a +3 bonus to dodge it.

Cruise missiles have excellent speed and range, but the standard tactic is to fire them at targets one mile away or closer. At these “point-blank” ranges the missiles cannot be dodged or destroyed; they travel at 1800 mph (2900 km), so they cover one mile in one-fifth of a second (one km in an eighth of a second). Too fast for any gunner system to react! Of course, the SF-69B first has to get within one mile and enemy fighters, robots and anti-aircraft systems will do their best to prevent this.

Primary Purpose: Anti-starship

Secondary Purpose: Strategic Bombardment

Mega-Damage: Nuclear warhead inflicts 2D6×100 M.D.; anti-matter warhead does 4D6×100 M.D.

Rate of Fire: One at a time or volley of two.

Effective Range: 1,000 miles/1600 km (optimum launching range is 1-3 miles, however).

Payload: Two missiles.

Note: These are smart bombs; +5 to strike. If fired from point-blank range (one mile), use the pilot's bonuses or +5, whichever is higher.

4. Combat Performance: In addition to any normal skill bonuses, the Scorpion is at +2 to dodge in space.

Proctor-Class

Long-Range Interceptor (CAF)

The Proctor is an oversized space fighter used by the Consortium to fulfill patrol roles in areas that do not warrant the deployment of a full frigate. It is meant to operate on its own, so Proctor fighters are often used as scouts, escorts and patrol ships. The vessels are often sold to private individuals and converted into private yachts, convoy escorts and small cargo ships. Converted Proctors are very popular among runners, mercenaries, pirates and adventurers. This ship has been in service for several centuries and over 260,000 are in service outside the regular CAF fleet. This may explain why hundreds of Proctors have recently appeared in the hands of the Free World Council, although the Transgalactic Empire suspects that the CAF may be secretly supplying the freedom fighters with the ships.

The Proctor has long-range travel capabilities and a G-drive. Unlike the average fighter, the ship has room for a handful of passengers, and has regular sleeping quarters, as well as a small cargo bay. The standard military model has an advanced “stealth” and sensor system, as well as an array of powerful weapons, including six cruise missiles. Most of these systems are removed before the ship is sold to private individuals, but fully outfitted Proctors can be found on the Black Market if one is willing to spend millions of credits on them.

Model Type: CAF LRF-25

Class: Long-range fighter/light frigate.

Crew: Four: Pilot/captain, co-pilot, gunner and communications/technical officer. Can accommodate an additional six passengers. Ten “coffins,” small cubicles with just enough room for one person lying down, are stacked in two rows around the ship's common room.

M.D.C. by Location:

Laser Cannons (2, on sides) — 300 each

Cruise Missiles (6, 3 under each “wing”) — 60 each

Medium Missile Launchers (2, one over each “wing”)— 180 each

Gravity Autocannon (1, on nose) — 150

Reinforced Pilot's Cabin — 250

*** Variable Force Field — 400 per side (2400 total)

** Main Body — 1450

** Depleting the M.D.C. of the main body means the ship is in tatters, with life support and contragravity systems knocked out, and is unable to fight or move under its own power (the missile batteries are another matter, however, see below). If the ship is reduced to -200 M.D.C., it explodes, doing 4D6×10 M.D. to anything in a 500 feet (152 m) area around the ship.

*** The force field protects six sectors: front, back, left, right, top and bottom. The pilot can regulate the density of the fields by concentrating energy on one sector.

Speed:

Driving on the ground: Not possible

Flying: Mach 10 in space, but in an atmosphere, speed drops to Mach 2.5.

FTL: G-Drive allows it to travel at four light years per hour.

Range: Limited by supplies and life-support. Usually can support 8 people for a four month trip, or six months under strict rationing or with extra supplies.

Statistical Data:

Height: 20 feet (6 m)

Width: 50 feet (15.2 m) at the body or 80 feet (24.4 m) at the wings.

Length: 80 feet (24.4 m)

Weight: 500 tons

Cargo: Cargo bay is 10 feet (3.0 m) tall and 20 feet (6.1 m) wide and long. Maximum cargo weight is 100 tons.

Power System: Anti-matter; average energy life is 50 years

Market Cost: 250 million credits to legitimate governments; 200 million credits to private individuals (remove advanced sensor and stealth systems, heavy laser cannon and cruise missiles); black market fully-equipped ships will sell for as much as 500 million credits (drop 50 million credits per sensor or weapon system missing in the ship).

Weapon Systems

1. Laser Cannons (2): One laser cannon is mounted on the left side of the fighter. It is the primary anti-fighter/light ship weapon system.

Primary Purpose: Anti-fighter

Secondary Purpose: Defense

Mega-Damage: 4D6×10 M.D. per blast.

Rate of Fire: Equal to combined hand to hand attacks of the pilot or gunner.

Effective Range: 10 miles (16 km)

Payload: Effectively unlimited.

2. Cruise Missiles: The Proctor is only issued these weapons during combat missions. Armed with them, the fighter can severely damage vessels of any size.

Primary Purpose: Anti-ship

Secondary Purpose: Anti-personnel

Mega-Damage: 2D6×100 M.D. (nuclear)

Rate of Fire: One at a time or volleys of two, three, four or six missiles.

Effective Range: 1000 miles (1600 km).

Payload: 6 missiles.

3. Medium Missile Launchers (2): These weapons are used to engage enemy fighters and robots.

Primary Purpose: Anti-spacecraft

Secondary Purpose: Defense

Mega-Damage: Varies with missile type.

Rate of Fire: One at a time or in volleys of 2, 4, or 8 missiles per launcher.

Effective Range: About 40 miles (64 km).

Payload: 16 total, 8 per launcher.

4. Gravity Autocannon: This nose weapon is another dogfight weapon.

Primary Purpose: Anti-spacecraft

Secondary Purpose: Defense

Mega-Damage: A burst is 20 rounds and inflicts 2D6×10 M.D. Can only fire bursts.

Rate of Fire: Equal to the number of combined hand to hand attacks per melee.

Effective Range: 5 miles (8 km) in space.

Payload: 4000 rounds; that's 200 bursts.

Flying Fang Interceptor (Transgalactic Empire)

The Flying Fang resembles an ancient Kreeghor weapon, the Fang, which consisted of two animal horns attached to a central handle, was used primarily as a stabbing weapon. This ship has two curved "horns" on each side which are actually high-powered laser cannons. The Flying Fang is designed to "stab" its targets with the lasers, or its other three weapon systems. This large fighter has enough firepower to threaten a frigate-class vessel, but its main purpose is to destroy enemy fighters and robots before they can threaten larger ships. They are also deployed on space stations and as part of planetary defense forces.

The Fang has an aerodynamic profile, allowing it to fight and maneuver well in an atmosphere. Its crew compartment is made for use by kreeghor pilots. There are human and other humanoid configurations, but they are relatively rare — the Imperials prefer to rely on kreeghor, to pilot these powerful fighters, and segregate other races to less capable vessels. A human trying to pilot a kreeghor-outfitted Flying Fang is at -2 to all combat actions/attacks and -15% on piloting maneuvers, due to the uncomfortable seating and layout of the weapon console.

Model Type: FF-100

Class: Space/Atmospheric Interceptor

Crew: One

M.D.C. by Location:

** Horn Laser Cannons (2) — 150 each

Dual Gravity Autocannons (2) — 80 each

Medium Missile Launchers (2, belly) — 120 each

Mini-Missile Launcher (1, top) — 80

* Main Body — 480

Reinforced Pilot's Compartment/Escapes Pod — 100

Variable Force Field — 200 per side (1200 total)

* Depleting the M.D.C. of the main body destroys the propulsion system and causes the escape pod to eject.

** Destroying a horn-wing will not affect the vehicle in space, but in an atmosphere it drops speed and maneuverability; reduce speed to Mach 2, and eliminate all maneuver bonuses.

Speed:

Driving on the ground: Not possible.

Flying: Maximum speed in space is Mach 10 (cruising and combat speed is typically Mach 5). Maximum atmospheric speed is Mach 4.

Range: Unlimited.

Statistical Data:

Height: 14 feet (4.3 m)

Width: 40 feet (12.2 m) from "horn" to "horn."

Length: 40 feet (12.2 m).

Weight: 10 tons (9070 kg).

Cargo: None

Power System: Anti-matter; average energy life of 25 years.

Market Cost: 55 million credits.

Weapon Systems

1. Horn Cannons (2): These are high-power laser cannons that fire simultaneous blasts at the same target.

Primary Purpose: Anti-ship

Secondary Purpose: Defense

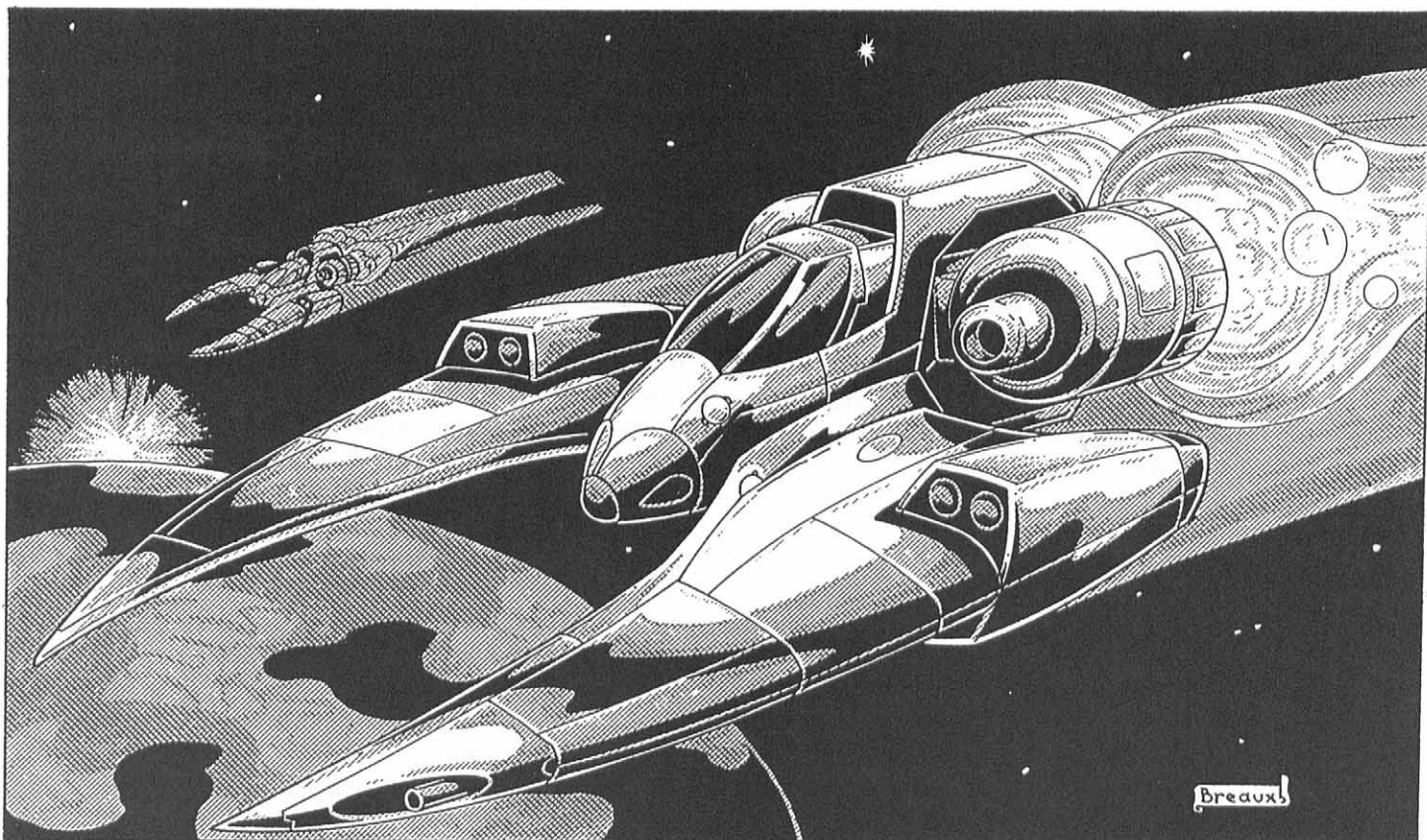

Mega-Damage: A double blast from both horns inflicts 2D6×10 M.D. A single cannon blast does 1D6×10 M.D.

Rate of Fire: Equal to the total number of hand to hand attacks of the pilot.

Effective Range: 2 miles (3.2 km) in space, 4,000 feet (1200 m) in an atmosphere.

Payload: Effectively unlimited.

2. Dual Autocannons (2): The nose of the aircraft has two gravity guns for close combat.

Primary Purpose: Anti-Ship

Secondary Purpose: Defense

Mega-Damage: A dual burst does 2D6×10 M.D. Each gun does 1D6×10 M.D. per 10 round burst.

Rate of Fire: Equal to the number of combined hand to hand attacks.

Effective Range: 3 miles in space (4.8 km), 4,000 feet (1200 m) in an atmosphere

Payload: 10,000 rounds each (2000 bursts total)

3. Medium Missile Launchers (2): The two missile launchers fire medium-range missiles. They are used to knock down fighters or attack larger vessels.

Primary Purpose: Anti-spacecraft and anti-ship.

Secondary Purpose: Defense

Mega-Damage: Varies with missile type. The typical payload is plasma/heat (2D6×10 M.D.) or multi-warhead (2D4×10 M.D.) smart bombs (+5 to strike).

Rate of Fire: One at a time or in volleys of one, two, four or eight.

Effective Range: 50 to 100 miles (80 to 160 km). Optimum attack range is under 50 miles (80 km).

Payload: Eight total, four on each launcher.

4. Mini-Missile Launcher (1): Over and behind the pilot's compartment is a mini-missile launcher used against short-range targets, or to destroy incoming missiles. This is an auto-loading launcher that has a missile magazine inside the ship.

Primary Purpose: Anti-ship and anti-missile.

Secondary Purpose: Defense

Mega-Damage: Varies with missile type.

Rate of Fire: One at a time or volleys of two.

Effective Range: About two mile (3.2 km).

Payload: 24 missiles.

5. Combat Performance: The Flying Fang is at +1 to strike and dodge in both space and atmosphere combat.

Broadsword Delta-Wing Multi-Environment Fighter (NE)

Like all Naruni Enterprise products, the Broadsword is a sleek, very effective combat fighter, complete with force fields, a wide array of weaponry and excellent speed and handling. The Free World Council has bought hundreds of these ships, and they have proven their worth against the best hardware the Transgalactic Empire has available. Broadswords are not very good atmospheric fighters and are best used in outer space.

The Broadsword's name describes its shape, which is flat, with a triangular nose and tiny "wings" (actually mini-missile launchers) that are located near the end of the aircraft (reminiscent of a sword's crossguard). All the weapon systems besides the missile launchers are built into the fuselage to protect them from enemy fire and are only visible as small notches in the ship's hull.

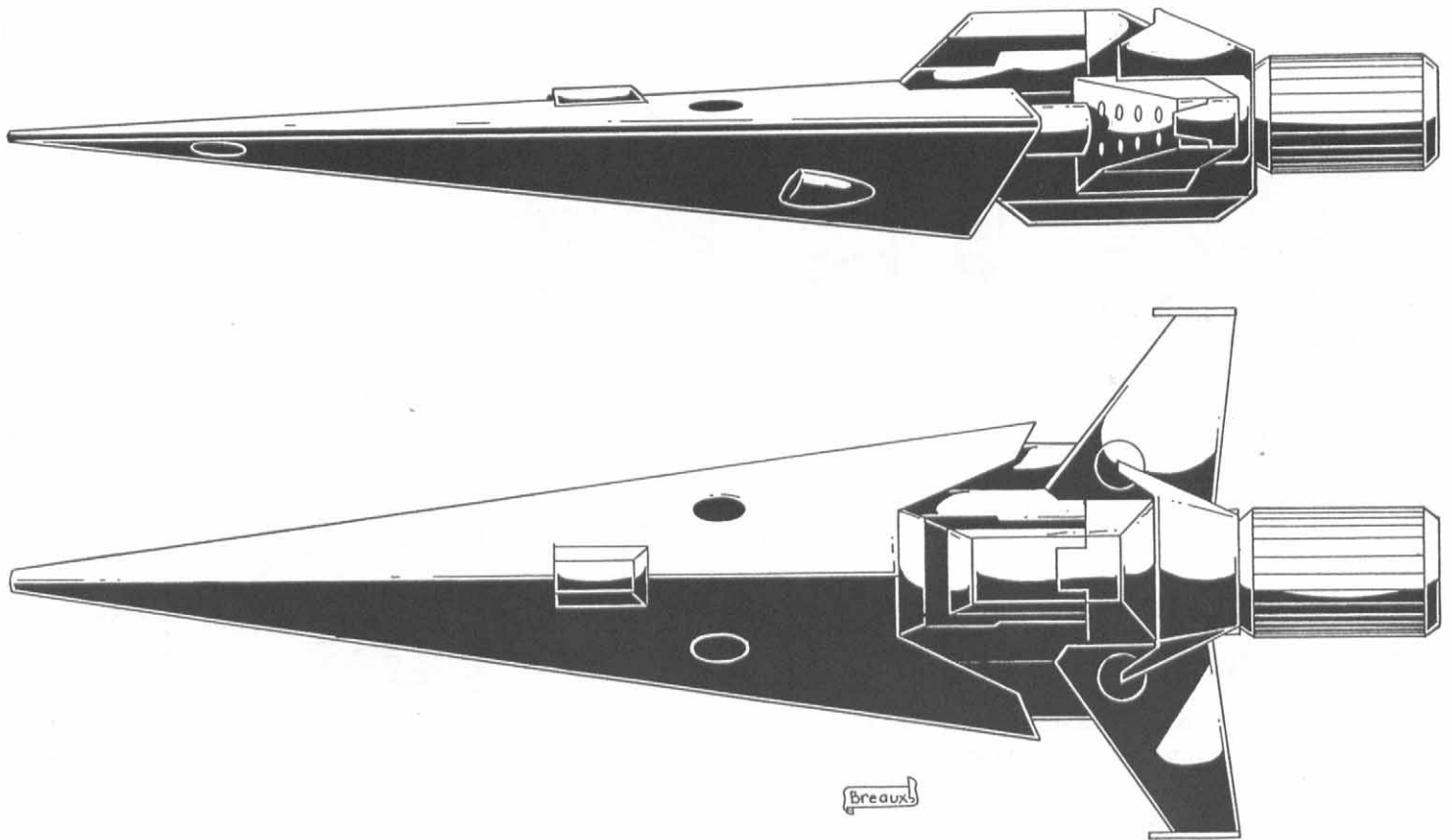

Model Type: NE-SF10

Class: Space fighter.

Crew: One.

M.D.C. by Location:

Mini-Missile Launchers (2) — 100 each

Reinforced Pilot's Compartment — 200

** Main Body — 550

Variable Force Field — 200 per side (1200 total)

** All the ships' weapon systems are built into the fuselage, except the mini-missile launchers. Depleting the M.D.C. of the main body destroys the ship and all weapon systems.

Speed:

Driving on the ground: Not possible.

Flying: Mach 9 in space, Mach 2 in an atmosphere.

Range: Effectively unlimited.

Statistical Data:

Height: 10 feet (3.0 m)

Width: 30 feet (9.1 m)

Length: 50 feet (15.2 m)

Weight: 20 tons (18,000 kg).

Cargo: None.

Power System: Nuclear; average energy life of 20 years.

Market Cost: 65 million credits.

Weapon Systems

1. Plasma Projectors (2): These nose-mounted guns fire relatively low-range but very powerful plasma bursts.

Primary Purpose: Anti-Ship.

Secondary Purpose: Defense.

Mega-Damage: A double blast does 3D6×10 M.D.

Rate of Fire: Equal to the number of combined hand to hand attacks.

Effective Range: 1 mile (1.6 km) in space, 2,000 feet (610 m) in an atmosphere.

Payload: Effectively unlimited.

2. Rail Guns (2): Twin rail gun cannons are mounted on the sides of the ship, and are fired simultaneously at the same target.

Primary Purpose: Anti-spacecraft

Secondary Purpose: Defense

Mega-Damage: A dual 80 round burst does 4D6×10 M.D. Can only fire bursts.

Rate of Fire: Equal to the number of combined hand to hand attacks.

Effective Range: 3 miles (4.8 km) in space, 4,000 feet (1200 m) in an atmosphere.

Payload: 8,000 rounds each; that's 200 bursts total.

3. Mini-Missile Launchers: Located on the sides and back of the ship, these launchers are used for anti-ship and bombardment purposes, or to knock down incoming missiles.

Primary Purpose: Anti-ship

Secondary Purpose: Defense

Mega-Damage: Varies with missile type.

Rate of Fire: One at a time or in volleys of 2, 4, 8, and 16 missiles.

Effective Range: About two miles (3.2 km).

Payload: 64; 32 missiles per launcher.

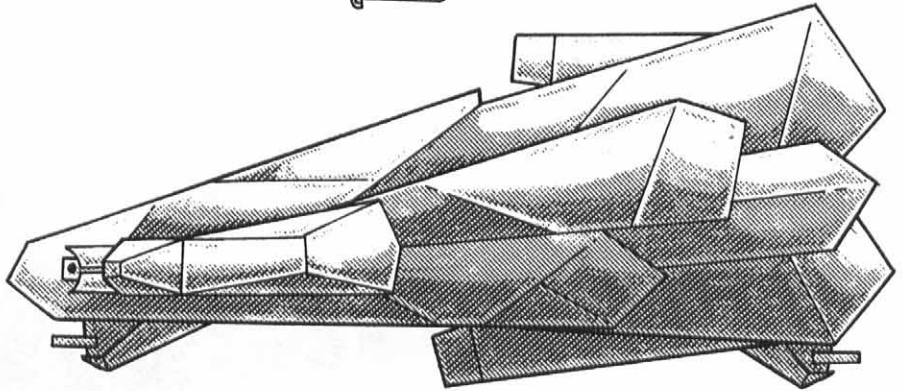
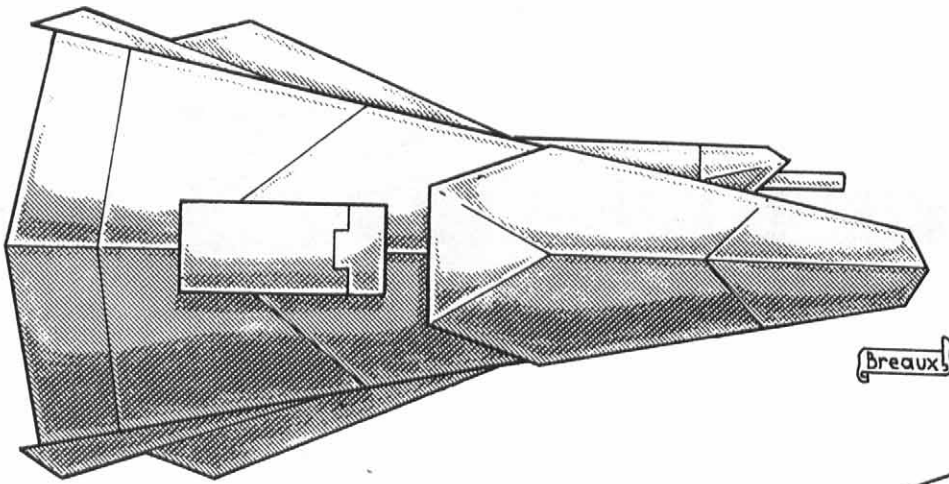

Star Ghost-Class Fighter (Phase World)

Star Ghosts have an unmistakable profile. First of all, they have a delicate, crystalline shape with an incredible, convoluted geometric latticework all over their hulls, making them look like a work of abstract art rather than a spaceship. Secondly, they glow in impossible colors and almost seem to twist and change if one stares at them too long. And when in flight, one can see right through the ships — as if they weren't really there, except for a "ghost" image. Even the most sophisticated visual systems will not "see" a solid object when they are in ghost mode.

Everybody who has gone up against a Star Ghost and survived knows only one thing for certain, they don't want to face another one ever again.

This ship and other small fighter-class and frigate-class ships are the only known vessels that rely completely on phase technology. Either the systems that give these ships all their strange powers do not work on larger vessels — or the prometheans simply haven't decided whether they need larger vessels. Some very old records mention shape-shifting dreadnoughts that could destroy entire fleets. Most people disregard those tales while hoping privately that they never have a chance to discover otherwise.

It's not that Star Ghosts are invulnerable. In terms of armor and overall performance, they are barely average compared to other ships. The difference lies in the ship's phase fields, which can make it insubstantial for brief periods of time, and which can disperse or "phase" out of the way of most incoming attacks. The ship can also make short teleporting jumps and is capable of the fearsome "one ship barrage," a quick sequence of jumps and attacks that make the ship appear to be shooting from several different directions at once!

The Star Ghost does have its limits. It can only perform its special maneuvers a few times before the phase generators temporarily overload. Also, the ship is very hard to pilot (pilots have to take a separate skill for the Star Ghost or similar phase-field fighters which is 20% lower than the conventional skill).

Star Ghosts are for sale on the weapons market. Many planetary governments have bought and dismantled the ships to find out how they work, only to discover the phase drives popping out of existence the moment anybody tried to take them apart! Both the CCW, the Transgalactic Empire and the UWW have small air wings of phase ships. So do the rebels of the Free World Council. Phase World, however, has more fighters of this class than all others combined.

Model Type: SG-1

Class: Strategic Fighter-Bomber.

Crew: One, plus it can accommodate/offer life support for up to three passengers.

M.D.C. by Location:

Phase Cannon (1) — 150

Laser Turrets (2) — 120 each

Mini-Missile Launchers (2, top and bottom) — 60 each

Cruise Missile Launchers (2, bottom) — 60 each

Reinforced Pilot's Compartment — 150

** Main Body — 440

** Depleting the M.D.C. of the main body will destroy the ship, making it useless. If half of the M.D.C. is destroyed, the ship loses all its special phase powers.

Speed:

Driving on the ground: Not possible.

Flying: Up to Mach 12 in space, or Mach 8 in an atmosphere!

Cruising speed is Mach 4 to 6. Plus, it has a P-drive that lets it travel at one light year per hour!

Range: Effectively unlimited. Life support and food on the basic ship will only sustain one person for up to a week, or 4 people for 48 hours. The ship can be reconfigured to keep four people alive for up to a week (or one person for a whole month), at the expense of the mini-missile launchers (replaced with extra life support systems and food).

Statistical Data:

Height: 35 feet (10.7 m)

Width: 40 feet (12.2 m)

Length: 65 feet (19.8 m)

Weight: 25 tons (22,700 kg).

Cargo: 4×4×4 feet (1.2×1.2×1.2 m)

Power System: Anti-matter; average energy life 25 years.

Phase Power System: All special phase abilities of the ship are powered by a *phase-field generator* that has 200 “charges.” When all these charges are spent (each use of a phase-field power uses up one charge), the generator needs one hour to regenerate power. Until it is fully recharged, no further special powers will be possible.

Market Cost: 280 million credits. Only planetary governments and mega-corps can afford them.

Weapon Systems

This firepower, coupled with their phase-jump powers, make it possible for a squadron of Star Ghosts to cripple a starship or even a battleship!

1. Phase Cannon (1): Like all phase weapons, this cannon does not damage machinery and inanimate objects, only living creatures and force fields. With a few shots, this cannon could kill all crew members of an enemy fighter while leaving the ship intact!

Primary Purpose: Anti-ship (anti-personnel)

Secondary Purpose: Anti-force field

Mega-Damage: 3D6 to all living targets in a 30 ft (9.1 m) diameter around the blast point or 1D6×10 to force fields and creatures 10 feet (3.0 m) or larger. This damage is S.D.C. to non-M.D.C. creatures and M.D. to M.D.C. creatures and force fields.

Rate of Fire: Equal to the number of combined hand to hand attacks.

Effective Range: 3 miles (4.8 km) in space. 10,000 feet (3,000 m) in an atmosphere.

Payload: Effectively unlimited.

2. Laser Turrets (2): Two medium-power laser turrets are located on the front and back of the ship respectively. They must be aimed separately at each target (cannot be fired simultaneously).

Primary Purpose: Anti-ship and anti-missile.

Secondary Purpose: Defense

Mega-Damage: 1D6×10 M.D., or three-shot pulse 3D6×10 M.D.

Rate of Fire: Equal to the total number of hand to hand attacks

Effective Range: 2 miles (3.2 km) in space. 4,000 feet (1,200 m) in an atmosphere.

Payload: Effectively unlimited.

3. Mini-Missile Launchers (2): These launchers are on the top and bottom of this bizarre-looking ship.

Primary Purpose: Anti-ship.

Secondary Purpose: Defense.

Mega-Damage: Varies with missile type.

Rate of Fire: One at a time or volleys of two, four, or eight.

Effective Range: About two miles (3.2 km).

Payload: 24, 12 on each launcher.

4. Cruise Missiles (2): The Star Ghost can be outfitted with two cruise missiles, typically with anti-matter warheads. This weapon is not designed for anti-fighter warfare, so fighters and robot-sized targets have a +4 bonus to dodge it. Cruise missiles have excellent speed and range, but the standard tactic is to fire

them at a range of one mile or less. At this “point-blank” range, the missiles cannot be dodged or destroyed (they travel at 1800 mph/2900 km, so they cover the one mile in one-fifth of a second, too fast for any gunner system to react).

Primary Purpose: Anti-Ship

Secondary Purpose: Bombardment

Mega-Damage: 4D6×100 M.D.

Rate of Fire: One at a time or volley of two.

Effective Range: 1000 miles (1600 km); optimal range is under one mile (1.6 km).

Payload: Two missiles.

5. Phase Fields: The Star Ghost can generate two protective fields around itself. The first one is a deflector field that disperses incoming energy attacks. While the field is activated, damage from all incoming attacks is divided by ten (with the exception of magic, psionics and other phase-weapons — all of which do normal damage even when the vessel is in phase!) However, as long as the deflector shield is on, the ship cannot use either its phase cannon or its missiles, only its laser turrets.

The second field is “ghost mode” an Out of Phase field (OP-field) that renders the ship insubstantial and immune to all non-magical attacks and energy! This power removes the vessel from normal three-dimensional space, rendering it invisible and insubstantial. While in this state, it can move and observe things in the three-dimensional world but is completely undetectable by normal means, including the see the invisible spell and most sensors (it is detectable to prometheans and phase technology). During this ghost mode, the ship’s speed is reduced to 25%, but it can move in any direction, including up and down, and is unimpeded by normal barriers (can go right through them like a ghost). The ship is only stopped by phase, magic and force field barriers. However, while the OP-field is on, the ship cannot fire any of its weapons. Nor can it resolidify inside another ship or solid object.

Duration: Deflector fields: Eight minutes per charge.
Ghost Mode: One minute per charge.

Payload: 200 “charges.” Each activation consumes one “charge” from the phase-field generator in the ship (see Power System, above). Activating either field counts as one melee attack/action. Activating a field can be used as a “dodge” to avoid incoming attacks. Only one field can be activated at any one time and not both simultaneously.

6. Phase-Jump System: The ship can make short-range teleportation “jumps.” Each jump counts as one melee attack or action and can cover up to two miles/3.2 km instantly! A pilot can combine jumps with attacks. For example, a pilot with six attacks could jump once, fire a weapon system, jump away again before the enemy can respond (this would count as a dodge), and fire from another position, and repeat! When fighting single-pilot fighters or robots, jumping and then attacking from an unexpected direction gives the phase ship a +2 to dodge, +2 on initiative and +1 to strike. When fighting a big ship, the phase ship is +2 to dodge, +3 on initiative and +2 to strike. Each jump uses up a “charge” from the phase-field generator (see Power System, above).

7. Combat Performance: In addition to its phase powers, the Star Ghost is at +1 to strike and dodge.

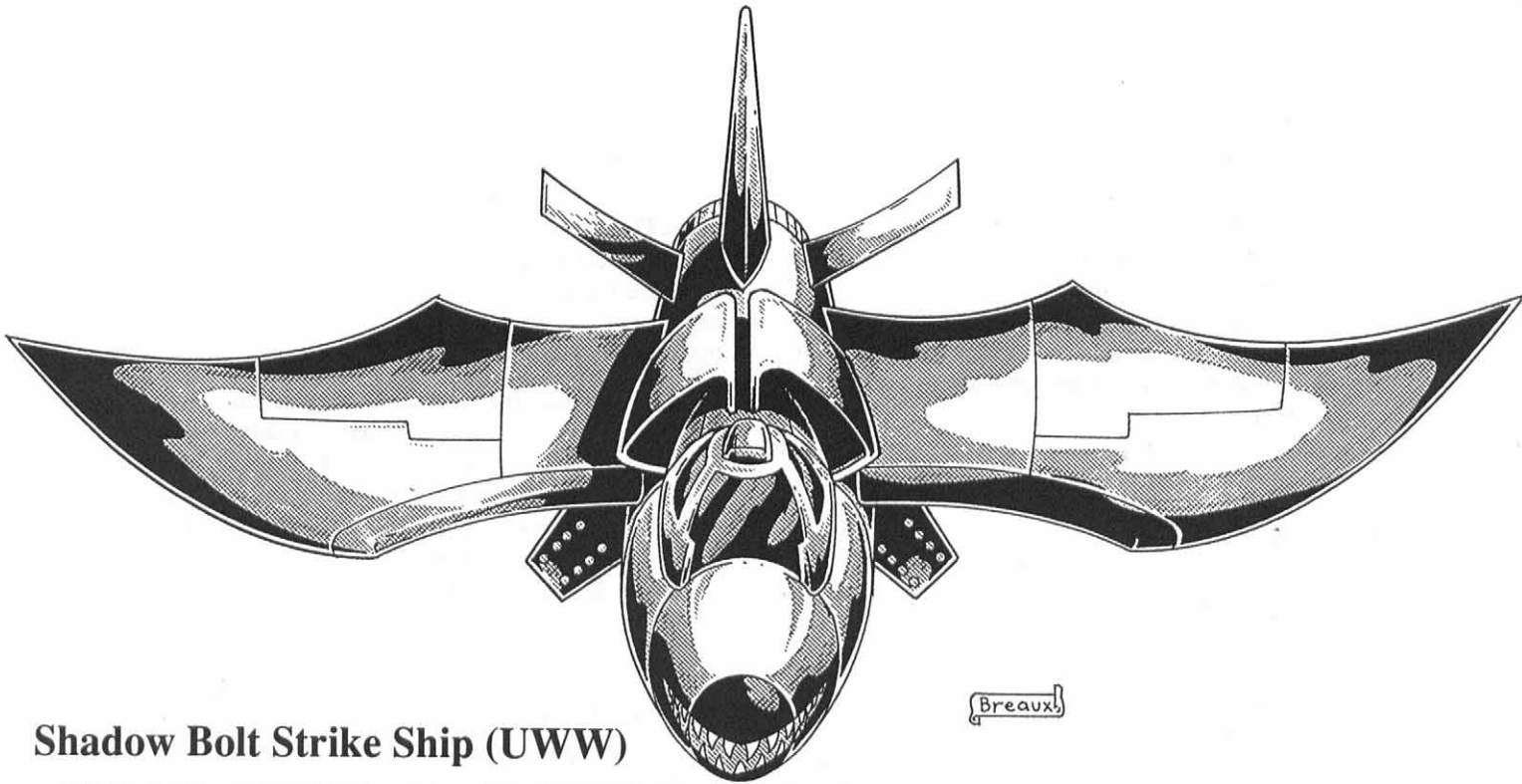

Shadow Bolt Strike Ship (UWW)

These are the mainstay fighting ships of the United Worlds of Warlock. The Shadow Bolt is a triumph of techno-wizardry and has several enchantments and special powers, including the vaunted *Bottled Demon* weapon system. The Shadow Bolt ships are enchanted with the Impervious to Energy spell, which renders them invulnerable to all laser, ion, microwave, plasma and particle beam attacks, but not missiles, rail guns, gravity guns, magic or phase weapons. They also generate a special version of the Armor of Ithan spell, which offers greater protection — like an invisible, second M.D.C. skin. They are very good as technological ships as well, although not as fast or maneuverable as the best fighters in the CAF or Imperial fleets.

The ship's lines are similar to those of a normal aircraft, with wings (shaped like a bat's for psychological intimidation) and an aerodynamic configuration, because the ship is meant to be used as an atmospheric fighter as well. The Shadow Bolt is usually painted black, with white or yellow drawings of monster's faces on the nose, like the Flying Tigers of WWII.

Model Type: WF-F15

Class: Dual-purpose interceptor and bomber.

Crew: One

M.D.C. by Location:

Wings (2) — 120 each

Bottled Demon Missile Launchers (2, beneath wings) — 100 each

Lightning Rod (1, in the nose) — 90

TK-Machineguns (2, one the sides) — 80 each

Reinforced Pilot's Compartment — 70

Armor of Ithan Force Field (3 times per day) — 180

Limited invulnerability against conventional energy weapons.

** Main Body — 400

** Depleting the M.D.C. of the main body destroys the fighter, but subtract damage from the mystic force field first. Also remember that it is magically impervious to most types of energy weapons, but not missiles, rail guns, gravity guns, magic or phase weapons.

Speed:

Driving on the ground: Not possible.

Flying: Maximum speed of Mach 9.5 in space, or Mach 4.5 in an atmosphere. Cruising speed in space is Mach 2 to 5.

Range: Effectively unlimited.

Statistical Data:

Height: 13 feet (4.0 m)

Width: 40 feet (12.2 m)

Length: 50 feet (15.2 m)

Weight: 9 tons (8200 kg)

Cargo: None.

Power System: Nuclear; average energy life is 10 years (relatively primitive).

Market Cost: 70 million credits.

Weapon Systems

1. Lightning Rod (1): This is a TW-lightning gun that fires magical blasts of electricity. The enchantment must be renewed every two months (costs 400 P.P.E. and 20,000 credits), but during that period the weapon can fire unlimited blasts.

Primary Purpose: Anti-aircraft

Secondary Purpose: Defense

Mega-Damage: 1D6×10 M.D. (magical; will affect beings and force fields that resist non-magical attacks).

Rate of Fire: Equal to the number of combined hand to hand attacks.

Effective Range: One mile (1.6 km) in both space and atmosphere!

Payload: Unlimited; although the spell must be renewed every two months, whether the weapon is used or not.

2. Bottled Demon Missile Launchers (2): This is one of the most controversial mixtures of traditional summoning magic and techno-wizardry recently devised in the Three Galaxies, as well as being a nasty combat weapon. Bottled Demon missiles are, literally, demons summoned and bound into a mis-

sile shell for use as an intelligent and aggressive targeting system! The evil creatures are filled with rage and hatred, and when one is fired it will fly after the target relentlessly; if it misses, the demon-missile will turn back and continue pursuing the target until it is destroyed (inflicting 50 M.D. to the missile will destroy the enchantment and send the demon back to its dimensional realm).

Bottled Demons are slightly bigger than mini-missiles and require special launchers (will not fit normal launchers). Treat them like super-smart missiles: +4 to strike and +5 to dodge. However, unlike conventional missiles that strike and explode, the bottled demon missiles keep coming, striking over and over again, three attacks/actions per melee round, until they are destroyed! The demons will not attack anybody other than the designated target and only as a missile (3D4×10 M.D.). If its target disappears, runs away/escapes or is destroyed, the demon missile vanishes because its purpose is fulfilled. The missile also disappears if it suffers 50 M.D.C. points of damage from enemy attacks. **Note:** There is a 3% chance that upon impact every time the demon missile strike the foul monster is released and can stay to fight the enemy, flee, or attack those who imprisoned it (the UWW forces).

Primary Purpose: Anti-Ship

Mega-Damage: 3D4×10 M.D. of magical energy every time the missile strikes (3% chance of releasing the demon every time it hits).

Rate of Fire: One at a time or volleys of two, three or four.

Effective Range: Effectively unlimited! Once fired, the demon controlled and powered missile will fly and pursue the designated target until its target or the missile is destroyed (or the target vanishes from sight; warps away, flies away, etc.).

Missile Speed: Mach 10 in space, Mach 2 in an atmosphere.

Missile Bonuses: +4 to strike and +5 to dodge.

Payload: 16; eight in each launcher.

3. TK-Machineguns: These are giant versions of the TK-machinegun techno-wizard devices described in Rifts, page 92. These weapons must be re-enchanted every two months (400 P.P.E. required for the enchantment).

Primary Purpose: Anti-Ship

Secondary Purpose: Defense

Mega-Damage: 6D6 M.D. per burst.

Rate of Fire: Equal to the number of combined hand to hand attacks

Effective Range: 2 miles (3.2 m) in space, 3,000 feet (914 m) in an atmosphere.

Payload: Effectively unlimited.

Military Shuttles

Shuttles are transport ships designed to carry cargo or personnel between ships and/or space stations, from planet to planet, or space station to planet and vice versa, and so on. They are also used as *lifeboats* in case of an emergency. In addition to these duties, military shuttles are designed to land troops on hostile planets and to carry boarding parties against spaceships or space stations. Some shuttles have FTL capabilities and are used as small cargo ships, or even as combat ships (usually in the hands of small planetary defense forces, or pirates).

CAF Assault Shuttle

This ship is the standard design used by the Consortium Armed Forces as lifeboats, small transports and attack shuttles. A wing or more can be found on most large starships and battleships. The shuttle can carry two platoons of soldiers and a dozen support vehicles, a company of soldiers or up to 300 refugees in cramped quarters. As a war vessel, it is heavily armed and armored, with over twice the M.D.C. of an equivalent civilian shuttle and enough weapons to give a small frigate a run for its money. Even so, troops are at their most vulnerable when they are in transit towards the target, so shuttles are the favorite target of planetary defenses, fighter aircraft, and flying robots.

Model Type: SAS-12

Class: Tactical Troop Transport (Space)

Crew: Seven. A pilot, copilot, communications/sensors officer, and four gunners.

Troop Capacity: Can carry ONE of the following troop units:

1. One Mechanized Infantry Company and attached Tank Platoons:

80 soldiers in standard body armor with full weaponry.

10 troopers in power armor (any)

5 Maniple IFVs

4 Shield-Bearer Missile Tanks

4 Phalanx Main Battle Tanks

2. One Power Armor Company and Tank Company:

40 soldiers in power armor (any)

30 soldiers in standard body armor with full weaponry.

2 Maniple IFVs

4 Shield-Bearer Missile Tanks

6 Phalanx Main Battle Tanks

3. Other troop units can be carried or it can take up to 300 people (no vehicles, and under cramped conditions) for evacuation purposes.

M.D.C. by Location:

Laser/Missile Turrets (4) — 150 each

Particle Beam Cannons (2) — 100 each

Reinforced Pilot's Compartment — 200

Door-Ramp (back) — 400

** Main Body — 2200

** Depleting the M.D.C. of the main body knocks out propulsion and all systems; it will drift in space or crash if flying in an atmosphere. Even one point below zero completely destroys the vessel. If destroyed while approaching a planet, the shuttle's passengers and crew will be destroyed upon entering the atmosphere!

Speed:

Driving on the ground: Not possible; can hover at up to 20 feet (6.1 m) off the ground.

Flying: Mach 6 in space or 400 mph (640 km) in an atmosphere; its squat, almost square profile makes the shuttle as aerodynamic as a rock. FTL systems are expensive options seldom used in combat shuttles.

Range: Effectively unlimited.

Statistical Data:

Height: 70 feet (21.3 m)

Width: 50 feet (15.2 m)

Length: 240 feet (73 m)

Weight: 1200 tons (1090 metric tons) fully loaded.

Caro: Without troops, the shuttle can carry 500 tons (450 met-

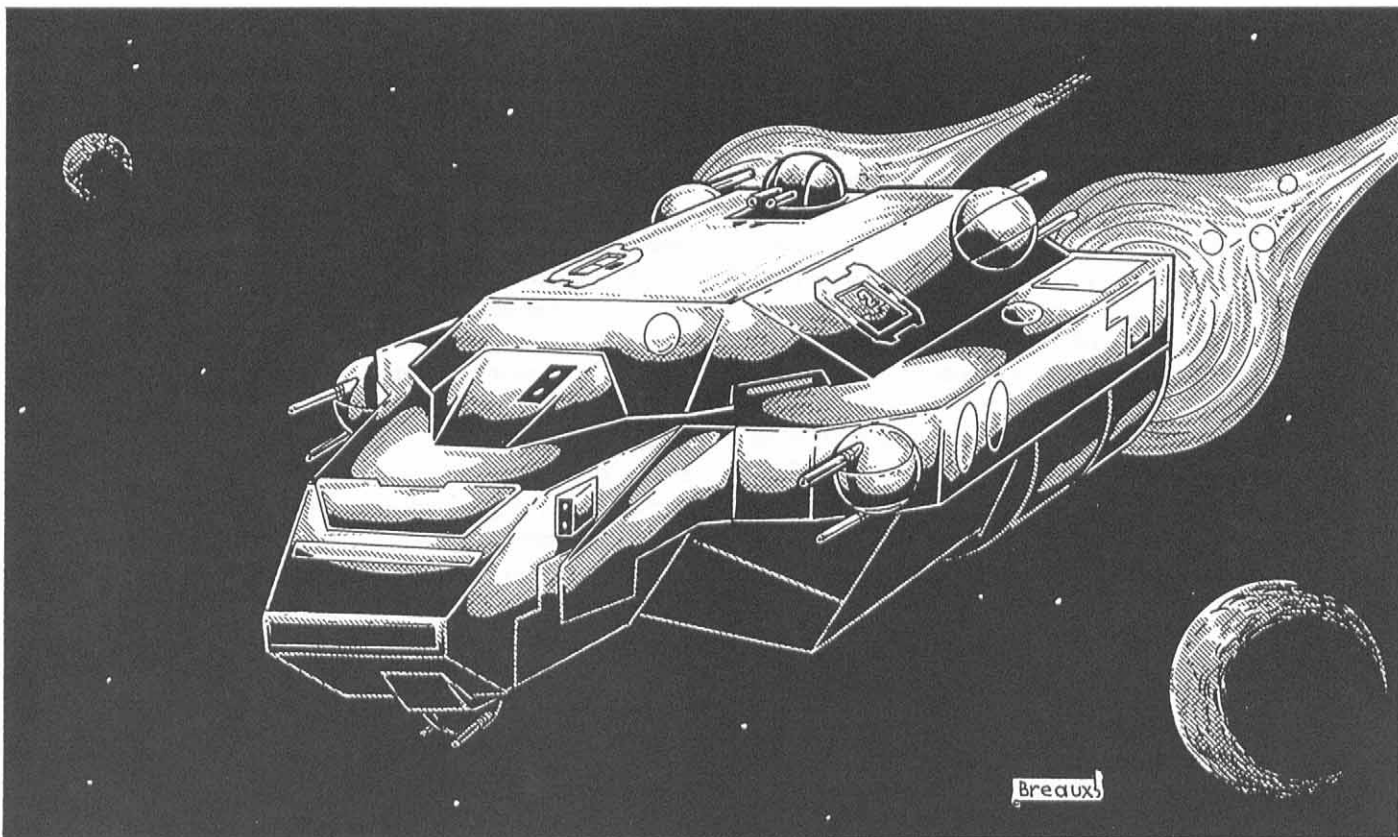

ric tons) of cargo. With its troop complement, the ship has minimal storage space (storage compartments for extra weapons, ammunition and supplies).

Power System: Anti-matter, average energy life of 40 years.

Market Cost: 150 million credits

Weapon Systems

1. Laser/Missile Turrets (4): These weapons are located on each of the four corners of the shuttle and are used to defend against space fighters and missile attacks. The gunner sits at a weapons station in the turret, or the weapon can be left on automatic (computerized gunner is +2 to strike).

Primary Purpose: Anti-aircraft

Secondary Purpose: Defense

Mega-Damage: Laser: 1D4×10 M.D. Mini-Missiles: Varies with missile type.

Rate of Fire: Laser: Equal to the number of combined hand to hand attacks of the gunner. Missiles: One at a time or volleys of 2, 4 or 8 missiles per turret.

Effective Range: Laser: 2 miles/3.2 km in space, or 4,000 feet (1200 m) in an atmosphere. Missiles: One mile/1.6 km (two in space/3.2 km).

Payload: Lasers: Effectively unlimited. Mini-Missiles: 32 per turret (128 total; four turrets).

2. Particle Beam Cannons (2): These guns are beneath the pilot's compartment and can be operated by the pilot, co-pilot or sensors officer. They are used to engage large enemy vessels, ground installations or massed troop formations. It has two settings. The first one fires a concentrated particle beam meant to burn through heavy armor. The other is a diffuse beam meant to fry several lightly armored targets (such as missile volleys or infantry).

Primary Purpose: Anti-ship

Secondary Purpose: Anti-Personnel/Defense

Mega-Damage: Has two settings: the first one does 4D6×10 M.D. to one target; the other does 5D6 M.D. to everything in a 50 ft (15.2 m) diameter. The particle beam guns cannot reach targets that are closer than 50 feet (15.2 m) away from the ship.

Rate of Fire: Equal to the number of combined hand to hand attacks.

Effective Range: 3 miles/4.8 km in space, or 1 mile/1.6 km in an atmosphere.

Payload: Effectively unlimited.

3. Combat Performance: Shuttles are not very maneuverable. Only the benefits of Basic Spaceship Combat apply, and even then the ship is at -2 to dodge attacks (-4 in an atmosphere), and a successful dodge takes one melee attack away from ALL the gunners in the ship (the violent and sudden movement knocks them all off balance).

“Rain of Death”

Troop Transports (Transgalactic Empire)

The gray-and-black “Rain of Death” vessels are planetary assault vehicles. As they descend toward a planet's atmosphere, this ship opens up with a savage barrage of missiles and smart bombs to “soften up” the opposition. By the time dozens or hundreds of these ships have landed, the ground below has been thoroughly saturated with explosives, decimating or destroying any defenders (and thousands of helpless civilians as well). The survivors are often too demoralized to put up a good fight.

These shuttles are heavily armored and have strong force fields to protect them against enemy attacks. Unlike other troop carriers, the shuttles have dozens of weapon hardpoints which

are manned not by ship's gunners, but by the troops the transport is carrying. Strangely enough, this is very helpful to the troop's morale, because they don't feel like helpless passengers, but part of the action even before they land and are deployed on the ground.

The main disadvantage of the "Rain of Death" is that it cannot carry as many troops as other shuttles. The Kreeghor strategists are too enamored with the firepower and armor for this vessel to replace it with a less well-defended troop carrier with more capacity. These ships have to make several trips back and forth from the larger motherships to the target planet. Sometimes, a beleaguered Imperial vessel has sent these shuttles in assault missions against enemy ships to reinforce decimated fighter and frigate squadrons. Although casualties have been fierce in those instances, these shuttles have managed to account for themselves quite well, even in missions for which they haven't been designed.

Model Type: TIV-TT1

Class: Assault Shuttle

Crew: Six; pilot, co-pilot and four gunners.

Troop Transport Capacity: Can carry as many as 60 soldiers (with or without powered armor), and 8 tanks or APCs, or 20 soldiers and one Domsday Machine, or 10 giant robots and 40 soldiers in powered armor, or as many as 12 vehicles.

M.D.C. by Location:

Laser Batteries (12) — 80 each

Mini-Missile Batteries (12) — 60 each

Gravity Cannon Batteries (4) — 150 each

Bomb/Missile Bays (4) — 300 each

Reinforced Pilot's Compartment — 200

** Main Body — 3,700

Force Field (regular) — 1,200

** Depleting the M.D.C. of the main body causes the shuttle to drift in space, or to crash if flying in an atmosphere; if destroyed while approaching a planet, the shuttle's passengers and crew will be destroyed when entering the atmosphere!

Speed:

Driving on the ground: Not possible. Can hover 20 ft. (6.1 km) above the ground.

Flying: Mach 4 in space, or 100 mph (160 km) in an atmosphere.

Range: Effectively unlimited.

Statistical Data:

Height: 80 feet (24.4 m)

Width: 80 feet (24.4 m)

Length: 200 feet (61 m)

Weight: 2,000 tons loaded (1800 metric tons).

Cargo: Minimal storage space.

Power System: Anti-matter; average energy life of 40 years.

Market Cost: Never on sale legally; on the black market it could go for as much as 300 million credits although it might be missing one or more weapon systems, or have reduced M.D.C.

Weapon Systems

1. Gravity Cannon Batteries (4): These four turrets have gravity cannons. There is one on each side of the ship, to engage enemy aircraft.

Primary Purpose: Anti-aircraft.

Secondary Purpose: Defense.

Mega-Damage: 4D6×10 M.D. per 20-round burst. Can only fire bursts.

Rate of Fire: Equal to the total number of hand to hand attacks of the gunner.

Effective Range: 16 miles (25 km) in space, half that amount in an atmosphere

Payload: 20,000 rounds (1,000 bursts)

2. Laser Batteries (12): These light laser batteries are manned by the soldiers being transported by the carrier, or left on automatic (+2 to strike via gunner computers). They are used to shoot down enemy missiles and space fighters, or to engage ground targets before landing. The gunner sits at a weapon station inside the turret, separated from the rest of the

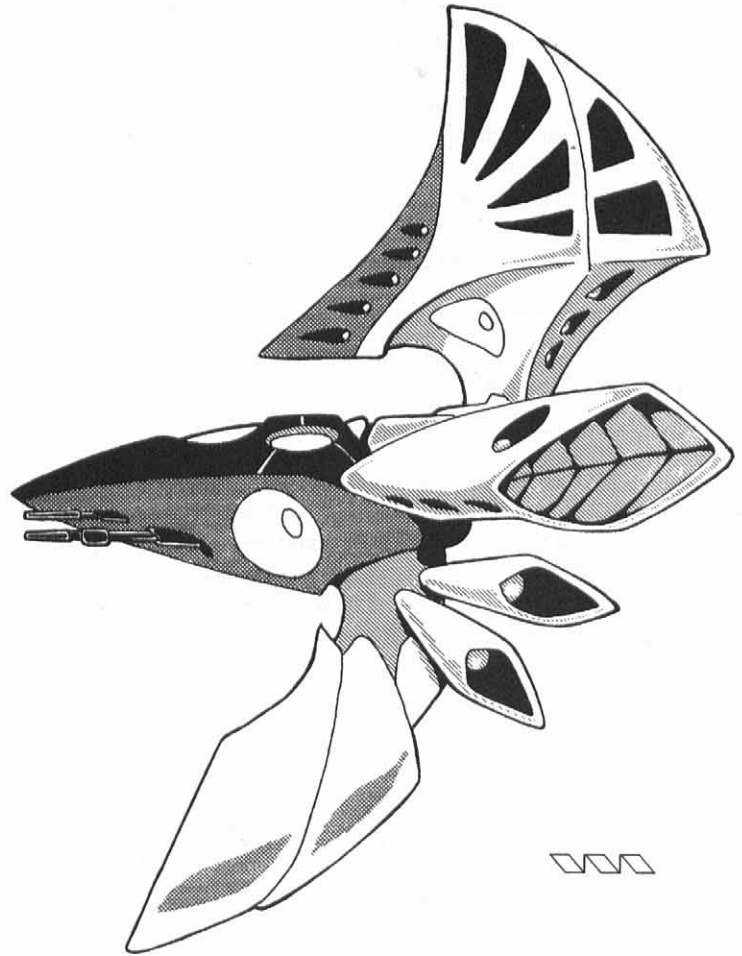

ship by an airlock. If the laser battery is destroyed, the gunner (if he survives) will be cut off from the ship!

Primary Purpose: Anti-aircraft.

Secondary Purpose: Defense, anti-personnel.

Mega-Damage: 1D4×10 M.D.

Rate of Fire: Equal to the total number of hand to hand attacks of the gunner.

Effective Range: 2 miles (3.2 km) in space, 4,000 feet (1200 m) in an atmosphere.

Payload: Effectively unlimited.

3. Mini-Missile Batteries (12): These launchers are also used by the passengers or through computerized systems, for the same purpose as the laser batteries.

Primary Purpose: Anti-ship and anti-personnel.

Secondary Purpose: Defense

Mega-Damage: Varies with missile type.

Rate of Fire: One at a time or in volleys of two, four or six per turret.

Effective Range: About two miles (3.2 km) (half that in an atmosphere).

Payload: 32 missiles per launcher (384 total).

4. Bomb/Missile Bays (4): These ports are located on the underbelly of the shuttle. As it is on its final approach, they open and start firing long-range missiles and smart bombs. These smart weapons are programmed to “search and destroy” important targets. Programmers (or the pilot) can determine the targeting priorities of the missiles; i.e., they can be ordered to engage tanks, then military bunkers, then artillery, then aircraft, then troop carriers, then robots, and so on, in any order deemed most appropriate. Missiles are +5 to strike. Bombs are +2 to strike and do the same damage as the long-range missiles (nuclear or multi-warhead).

In a space battle, the missiles (but not the bombs) can be used against any enemy spaceships. The bombs can be dropped over other, larger vessels or as drifting mines that detonate on impact (or zip after specific targets that come within range).

Primary Purpose: Bombardment and anti-armor.

Secondary Purpose: Anti-ship

Mega-Damage: Varies with missile type. Usually 3D6×10 or 4D6×10 M.D.

Rate of Fire: Up to 16 missiles, 32 bombs, or any combination of the two can be shot/released in one melee round. Bombs will blanket an area with a radius of 300 feet (91.5 m) per four bombs dropped (32 bombs will cover a 2400 feet/280 m area!). Missiles will attack the nearest targets of the assigned class (each missile has a sensor range of 10 miles/16 km).

Effective Range: Varies with missile type; bombs have a 200 mile range (320 km).

Payload: Typically carries 48 missiles and 68 bombs. Two bombs can be replaced by one missile and vice versa.

5. Combat Performance: The shuttle is a poor fighting aircraft. Only bonuses from basic air-space combat apply, and even then the ship is at -2 to dodge (-4 in an atmosphere), and a successful dodge takes one attack away from ALL the gunners in the ship (a violent movement knocks them all off balance).

Star Frigates

Frigates are light ships (but several times larger than fighters) with a full crew complement. They range in weight from 5,000 to 10,000 tons (4500 to 9000 metric tons) and range in length from 200 to 600 feet (61 to 183 m). They often act as escorts for larger ships, or as patrol ships, planetary defenders, and scouts. Many independent planets have a fleet made up mainly of frigates, especially when they cannot afford larger ships, and frigates are capable enough to defend a planet and patrol their trade routes. The Kreeghor used to favor this class of vessel. Their favorite tactic was to send hundreds, or even thousands of frigates in swarm attacks to overwhelm larger ships by sheer weight of numbers. Eventually, the losses involved in such attacks became prohibitive and the Transgalactic Empire now relies on larger ships, but frigates still make up a large portion of its fleets.

Scimitar-Class

Light Patrol Ship (CAF)

The Scimitar is a common patrol and escort ship. Big enough to handle a squadron of fighters, its main guns can seriously damage larger vessels and its combined armor and force fields can take a pounding from all but the heaviest weapons — at least for a short while. The Scimitar is fast and maneuverable, plus it is small enough to be able to operate in an atmosphere with only minimal maneuvering penalties. The Scimitar is shaped like a giant rocket or missile, with tiny wings on the side. Its main guns protrude menacingly from each side of the front section/command bridge and its fighter/power armor bay is located on its underside. Secondary weapon turrets are placed at strategic points to cover the entire ship.

Besides its own firepower, the Scimitar has a fighter wing and a power armor squadron (6 fighters and 10 power armor troops). The Scimitar is too small to carry shuttles; instead, it has six small escape pods with 100 M.D.C. each that can carry up to

20 people and keep them alive for a week. About 10,000 Scimitars are in CAF service, spread among twenty main fleets and two hundred patrol routes, space station garrison details, and other light vessel missions. Several thousand decommissioned ships are in private hands, or serving under independent planetary forces (or converted into small trading/smuggling/pirate ships). These decommissioned ships are supposed to have reduced M.D.C., force fields, and less powerful weapon systems. The ships are stripped of most military components before being sold. However, captured ships will have all systems intact — and many decommissioned ships are refitted with additional armor and replacement armaments (although still typically 10% to 20% less than military issue).

Model Type: SF-20

Class: Frigate Combat and Patrol Ship.

Crew: 96, plus 100 troops, including officers. Has room for as many as 640 additional troops/people, but in cramped conditions in the cargo holds — it only has staterooms for about 200 additional passengers.

M.D.C. by Location:

Main Laser Cannons (2) — 800 each

G-Cannon Turrets (2) — 200 each

Particle Beam Cannons (4) — 150 each

Mini-Missile Launchers (8) — 100 each

Fighter Hangar Door — 600 each

Variable Force Fields — 1,000 each side (6,000 total)

* Bridge — 2,000

** Main Body — 5,000

*** Main Engines (2, on the sides) — 1,200 each

* A direct hit on the bridge doing more than 200 M.D. may injure or kill the bridge crew. If the bridge is destroyed, the ship can be controlled from the engineering room, inside the ship, but all piloting skills are -20% and combat rolls are -2.

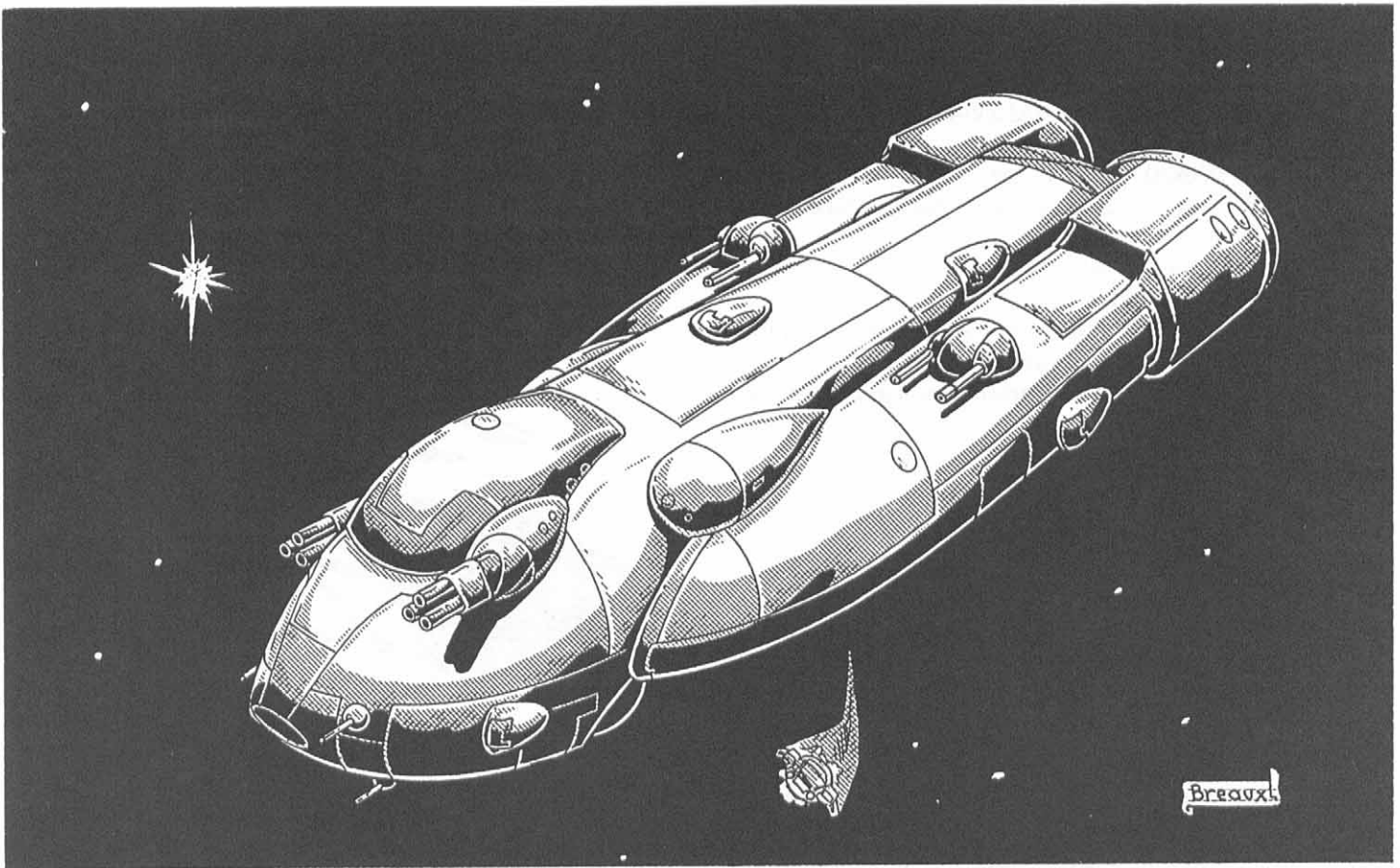

** Depleting the M.D.C. of the main body shuts the ship down, causing it to drift in space. The secondary weapon turrets have independent power supplies, however, and can fight on. If the ship is reduced to -1,000 M.D.C., it blows up, causing 4D6×1000 M.D. to anything in a 300 foot (91.5 m) area.

*** Destroying the main engines eliminates FTL systems and leaves only sub-light systems.

Speed:

Driving on the ground: Not possible.

Flying: Mach 8 in space (maximum speed). Or up to Mach 2 in an atmosphere. Cruising speed is Mach 3 to 4.

Star Drive: Gravitonic drive maximum speed: 5 light years / hour.

Range: Effectively unlimited. Carries enough life support and supplies (including hydroponic garden) for two years of uninterrupted travel (could be stretched to five or six in an emergency). Typical patrol mission lasts six months in space.

Statistical Data:

Height: 80 feet (24.4 m)

Width: 140 feet (42.6 m), wingspan of 220 feet (67 m)

Length: 500 feet (152 m)

Weight: 12,000 tons fully loaded, plus up to 1,000 tons of extra cargo.

Cargo: Cargo hold is 20 feet (6.1 m) tall, 20 feet (6.1 m) wide and 200 feet long (61 m), providing 4,000 square feet (372 square m) and 80,000 cubic feet (2300 cu.m) of space. Maximum cargo weight is 1,000 tons (907 metric tons). Does not count normal complement of supplies and equipment.

Power System: Anti-matter; average energy life is 50 years.

Market Cost: 400 million credits to governments (the CCW only sells this ship to member planets or respectable planets); or

the "army-surplus" version which can cost from 100 to 200 million credits (reduce M.D.C. by 30%, remove all weapon systems, stealth system and advanced sensory systems, plus power armor and fighters are NOT included).

Weapon Systems

- 1. Laser Cannons (2):** These are heavy artillery pieces used to engage large ships, space stations and other important targets. The cannons can be aimed towards different targets, or used simultaneously to blast the same target.

Primary Purpose: Anti-ship.

Secondary Purpose: Anti-building.

Mega-Damage: 2D6×100 M.D. per cannon, or a double blast does 4D6×100 M.D.

Rate of Fire: Twice per melee round each (or two double blasts).

Effective Range: 16 miles (25 km)

Payload: Effectively unlimited.

- 2. G-Cannons (2):** Each cannon is in a separate turret, operated by a gunner or a gunner program (+2 to hit, 3 attacks per melee). It is used for anti-ship combat, or to engage enemy fighters and robots if they get past the ship's normal defense (robots and fighters are +2 to dodge these attacks, however).

Primary Purpose: Anti-ship

Secondary Purpose: Anti-spacecraft and anti-missile.

Mega-Damage: A burst is 80 rounds and does 1D4×100 M.D.; can only fire bursts.

Rate of Fire: Equal to the total number of hand to hand attacks of the gunner.

Effective Range: 10 miles (16 km)

Payload: 32,000 rounds per turret (400 bursts)

3. Particle Beam Cannons (4): Four turrets with light particle beam cannons, used both to engage enemy vessels and to knock down missiles and fighters.

Primary Purpose: Anti-spacecraft and anti-missile.

Secondary Purpose: Anti-ship

Mega-Damage: 3D6×10 M.D. per blast.

Rate of Fire: Equal to the total number of hand to hand attacks of the gunner.

Effective Range: 6 miles (9.6 km)

Payload: Effectively unlimited.

4. Mini-Missile Launchers (8): These are missile turrets used for point defense against enemy fighters and missiles. Each turret usually fires volleys of 4 missiles per target to insure a kill.

Primary Purpose: Anti-spacecraft and anti-missile.

Secondary Purpose: Defense

Mega-Damage: Varies with missile type. Usual load is a mix of plasma and armor-piercing missiles.

Rate of Fire: One at a time or volleys of four or eight missiles.

Effective Range: About two miles (3.2 km).

Payload: 128 missiles per launcher-turret (1,024 missiles) plus cargo hold carries an additional 2,048 missiles. Reloading a turret from the cargo hold takes 1D6 minutes.

5. Aircraft and Military Vehicles: In addition to its main weaponry, the Scimitar has a complement of 6 Scorpion SF-69B (fighter-bombers) and 10 Silverhawk power armor. It also has an infantry company of 100 soldiers, including 12 Ground-Pounder powered armor suits. The Scimitar's standard load does not normally include large troop concentrations or military vehicles.

6. Combat Performance: Spaceship Combat Bonuses (Basic) apply, but the ship is -2 to dodge against attacks at 3 miles (4.8 km) or closer.

Berserker Class Warship (Transgalactic Empire)

The Berserker is an ultra-tech version of the torpedo boats of the 20th century. These light ships are starship-destroyers with one main mission: To close in at point-blank range and then unleash a murderous barrage of anti-matter missiles, enough to destroy anything smaller than a dreadnought. They have a variable force field and typically rush in with all shields concentrated on the front side; this means enemy ships would have to inflict over 9,000 M.D.C. damage to stop the frigate! The Berserkers are also used for patrol and reconnaissance missions and can get the better of most vessels of their class in a one-to-one fight. This frigate has a distinctive profile, with its main laser cannons protruding from its belly like two horns or pincers. Its two main missile batteries are in the front, side by side.

The ship has some disadvantages. It has no troop complement space fighters or robots and a limited selection of close-range weapon systems. In large-scale combat, it is screened by fighters launched from a large carrier ship, but in a skirmish or one-to-one fight, the Berserker is on its own.

Model Type: TIV-AS

Class: Light Attack Vessel/Missile Ship.

Crew: 94

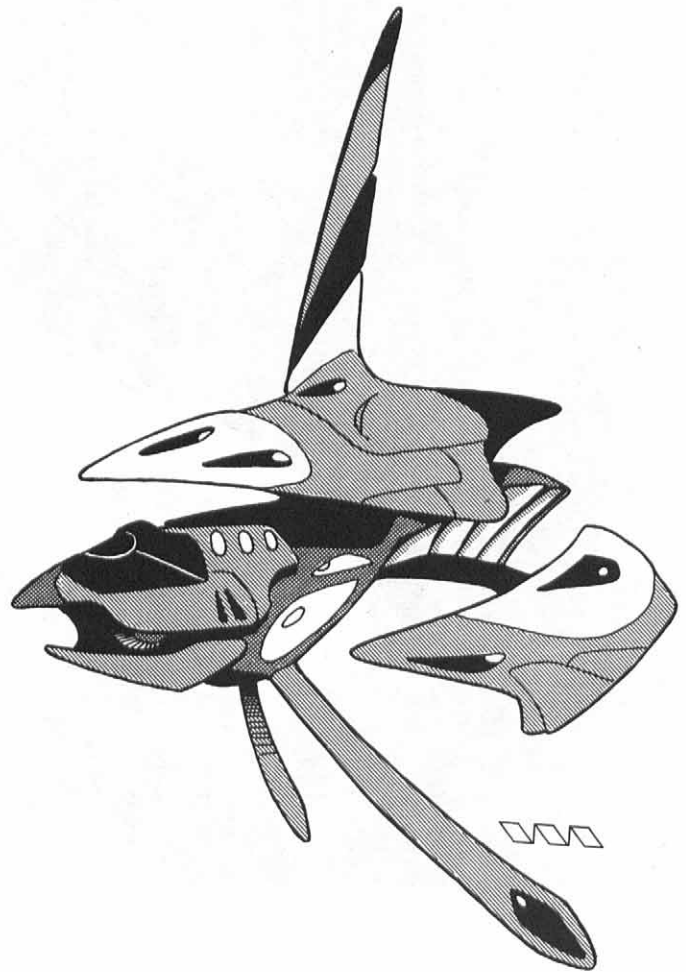

M.D.C. by Location:

Laser Cannons (2, underside) — 700 each

Cruise Missile Launchers (2, front) — 1,000 each

* Bridge — 1,500

GR-gun-Missile Batteries (8) — 400 each

** Main Body — 3,000

Variable Force Field — 1000 per side (maximum 6000)

* Destroying the Bridge will eliminate the main computer and controls. The ship can be controlled from the engineering section deep inside the ship, but those controls are less sensitive (-2 to strike, parry and dodge from there and piloting is at -10%).

** Depleting the M.D.C. of the main body means the ship is in tatters, with life support and contragravity systems knocked out, and is unable to fight or move under its own power (the missile batteries are another matter). If the ship is reduced to -1,000 M.D.C., it explodes, doing 1D4×10,000 M.D. to all other ship components and any target within 1000 feet (305 m).

Speed:

Driving on the ground: Not possible.

Flying: Mach 9 in space; not designed to fly in an atmosphere.

Star Drive: Gravitonic drive, maximum speed: 4 light years per hour.

Range: Effectively unlimited.

Statistical Data:

Height: 104 feet (32.7 m) from the horn-cannons to the top of the ship, or 80 feet (24.4 m, main body only)

Width: 65 feet (19.8 m).

Length: 300 feet (91.5 m)

Weight: 7,000 tons (6300 metric tons) fully loaded.

Cargo: Small cargo hold is 20×20×20 feet (6.1×6.1×6.1 m) or 400 square feet (37 square meters) and 8000 cubic feet (227 cu.m). Most of the ship is taken up by armor, inner hulls and redundant systems, or used to store extra weapons and ammunition. Emptied of all extra ammo, and if M.D.C. is dropped by half, the ship could carry half its total weight in cargo.

Power System: Anti-matter; average energy life of 45 years.

Market Cost: 250 million credits. Never sold to the public. Black market knock-offs or captured ships may be missing as much as 50% of its M.D.C. and some or all of its weapon systems, and will not be much cheaper, either.

Weapon Systems

1. Horn Lasers (2): These underside-mounted laser cannons fire high-intensity beams meant to melt and burn large ships. They can engage different targets, or perform simultaneous attacks.

Primary Purpose: Anti-ship

Mega-Damage: 1D6×100+100 M.D. per single blast, or 2D6×100+200 M.D. per double blast.

Rate of Fire: Two per melee per cannon or two double blasts.

Effective Range: 16 miles (25 km)

Payload: Effectively unlimited.

2. Cruise Missile Launchers (2): The deadliest weapon of the Berserker is its missile system. Its favorite tactic is to close within 1 to 3 miles (1.6 to 4.8 km) and fire volleys of 20 missiles doing a combined 4D6×2000 M.D.!

Primary Purpose: Anti-ship.

Secondary Purpose: Assault.

Mega-Damage: Each missile does 2D6×100 or 4D6×100 M.D. Countermeasures will work if missiles are launched at a distance greater than three miles. Otherwise, the missiles will reach the target in less than one second! Only a counter-volley of 20 missiles or more will stop the barrage (roll 2D6+8 to determine how many cruise missiles were destroyed; the remainder will hit the target).

Rate of Fire: Volleys of 10 per launcher, per melee round, for a total of 20 missiles per melee. Launchers are reloaded on the same melee and can fire again on the next.

Effective Range: Over 1,000 miles (1600 km), but optimum range is 1 to 3 miles (1.6 to 4.8 km).

Payload: 100 total. 50 missiles per launcher.

3. GR Gun/Missile Batteries (8): These are weapon turrets with a gravity gun and a co-axial mini-missile launcher used for point defense and anti-aircraft fire. When the ship is operating on its own, these batteries are its only line of defense against fighters and robot vehicles.

Primary Purpose: Anti-aircraft and anti-power armor.

Secondary Purpose: Defense

Mega-Damage: GR Gun: 3D6×10 M.D. per 40 round burst. Mini-Missile: varies with missile type (usually plasma or armor piercing 1D4×10 or 1D6×10 M.D.)

Rate of Fire: GR Gun: Equal to combined hand to hand attacks per melee. Mini-Missile: One at a time or volleys of two or four missiles.

Effective Range: 2 miles (3.2 km) for both weapons.

Payload: 8,000 rounds/200 bursts for the gun and 32 missiles per turret (256 total).

4. Combat Performance: No modifiers.

Merchant and Transport Ships

Typical Runner Ship

This is a small and light cargo ship ideal for slipping through planetary defenses. It includes a stealth system that cannot be detected unless it gets within 5,000 miles (8000 km) of enemy ships. Runner vessels are better armed than most civilian ships and have variable force fields.

Class: Light Cargo Ship

Crew: Five

M.D.C. by Location:

Laser Turrets (3) — 300 each

Cockpit — 500

Force Field — 300 per side (1800 total)

** Main Body — 2000

** Depleting the M.D.C. of the main body means the ship is in tatters, with life support and contragravity systems knocked out, and unable to fight or move under its own power except for launching missiles. If the ship is reduced to -200 M.D.C., it explodes, doing 1D4×100 M.D. to all other ship components and any target within 1000 feet (305 m).

Speed:

Driving on the ground: Not possible

Flying: Mach 4 in an atmosphere, Mach 10 in space, and can travel at 5 light years per hour using a CG-drive.

Range: Effectively unlimited; life support will keep the crew alive for four months.

Statistical Data:

Height: 30 feet (9.1 m)

Width: 30 feet (9.1 m)

Length: 100 feet (30.5 m)

Weight: 300 tons (270 metric tons)

Cargo: Can carry up to 100 tons (90 metric tons) of cargo.

Power System: Nuclear; average energy life of 15 years.

Market Cost: 30 million credits

Weapon Systems

1. Laser Turrets (3): Each turret has a high-powered laser array.

Primary Purpose: Anti-Ship.

Secondary Purpose: Defense.

Mega-Damage: 2D6×10 M.D. per blast.

Rate of Fire: Equal to number of hand to hand attacks of the gunner.

Effective Range: 6000 feet (1828 m).

Payload: Effectively unlimited.

2. Long-Range Missile Tubes (2): These launchers are built into the ship's main body. The launchers can only engage targets in front of the ship.

Primary Purpose: Anti-Ship

Secondary Purpose: Defense

Mega-Damage: Varies with missile type.

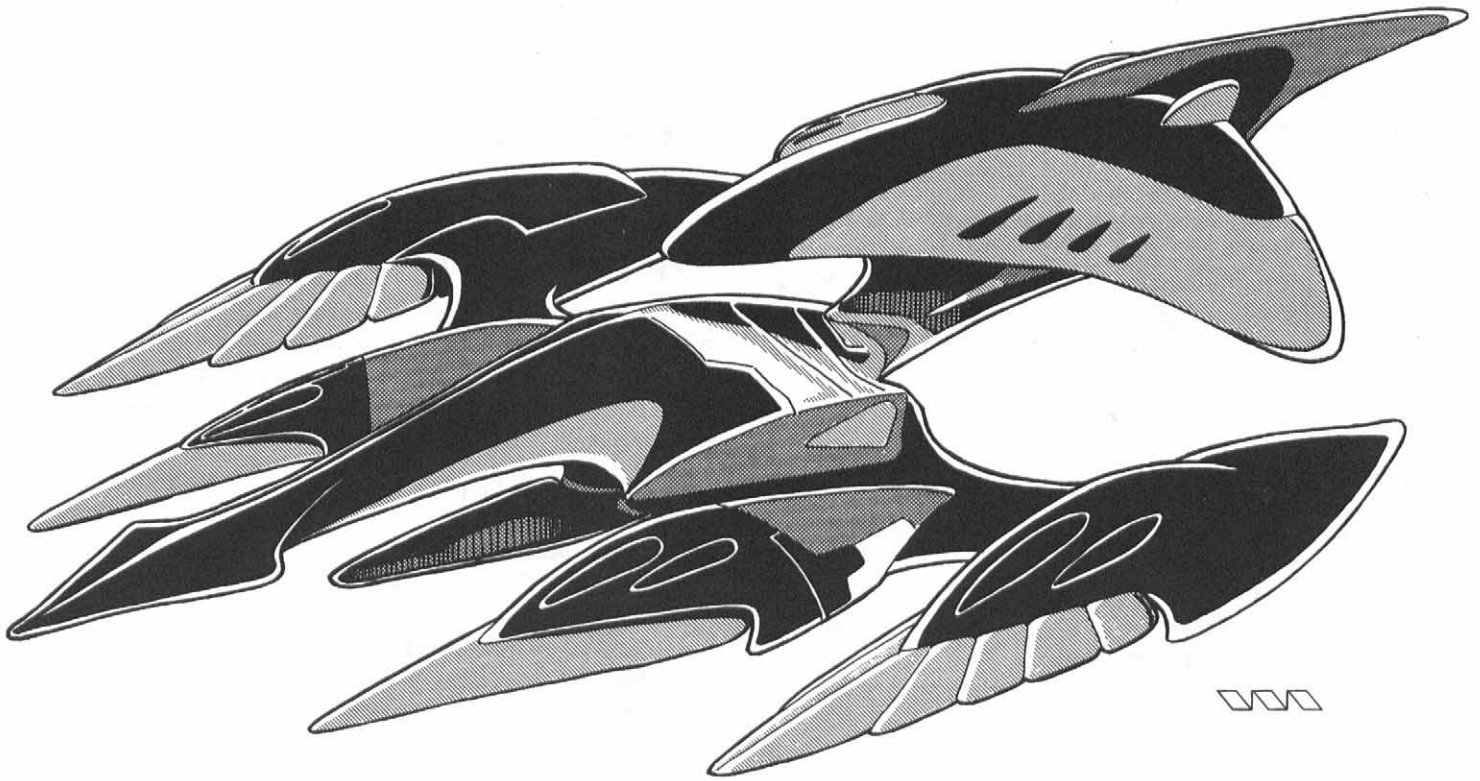

Rate of Fire: One at a time or volleys of two, four or eight missiles.

Effective Range: About 500 miles (800 km).

Payload: 48; 24 missiles per launcher. Extra loads can be kept in the cargo hold (1 ton per 48 missiles).

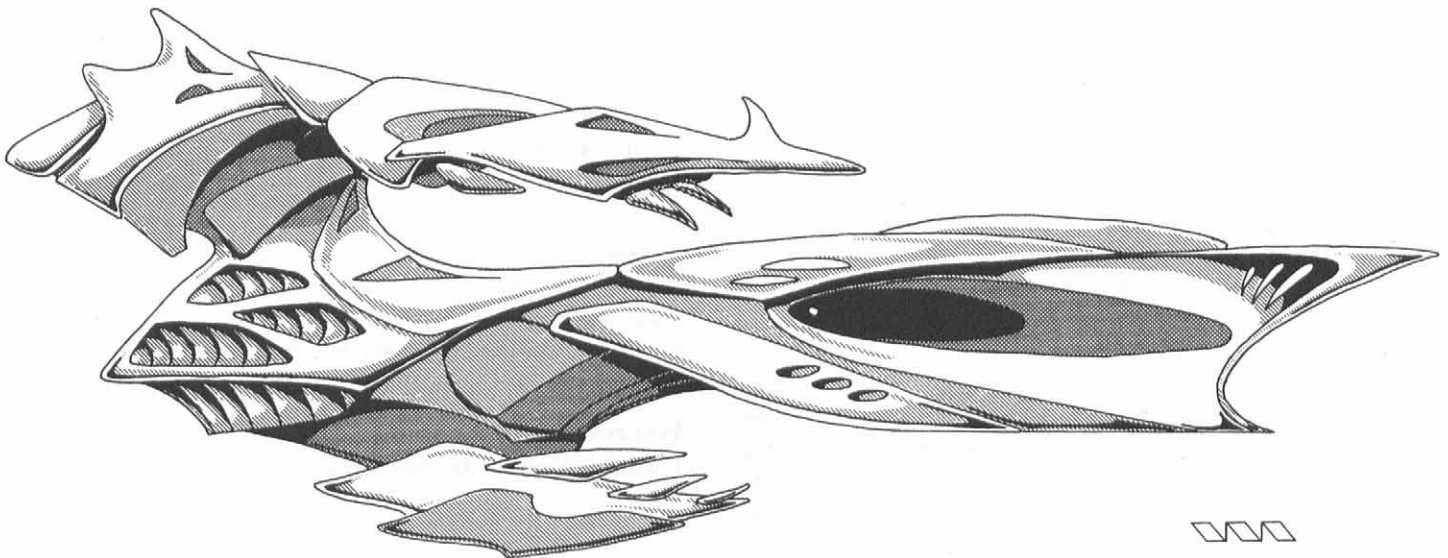

Typical Merchantman

This is a common cargo freighter used by most merchants and even some runners. It has light weapon systems and force fields for self-defense, and is not particularly fast or maneuverable.

Class: Freighter

Crew: 30

M.D.C. by Location:

G-Drives (2) — 2000 each

Main Drive (back 1/5 of the ship) — 3000

Laser Batteries (4) — 500 each

Missile Batteries (4) — 300 each

Force Field (regular) — 1200

* Bridge — 1000

** Main Body — 5000

* Destroying the Bridge will eliminate the main computer and controls. The ship can be controlled from the engineering section deep inside the ship, but those controls are less sensitive (-2 to strike, parry and dodge from there and -15% to pilot rolls).

** Depleting the M.D.C. of the main body means the ship is in tatters, with life support and contragravity systems knocked out, and unable to fight or move under its own power except to launch missiles. If the ship is reduced to -1,000 M.D.C., it explodes, doing 1D4x1,000 M.D. to all other ship components and any target within 1000 feet (305 m).

Speed:

Driving on the ground: Not possible.

Flying: Up to Mach 7 in space (cannot fly in an atmosphere).

Its CG-drive allows the ship to travel at 3 light years per hour.

Range: Limited only by supplies; carries enough food and life support components to keep crew alive for up to 6 months in relative comfort; can be stretched to 9 months in an emergency.

Statistical Data:

Height: 70 feet (21.3 m)

Width: 90 feet (27.4 m)

Length: 600 feet (183.3 m)

Weight: 10,000 tons (9100 metric tons)

Cargo: Can carry up to 5,000 tons (4500 metric tons) of cargo.

Power System: Nuclear; average energy life of 15 years.

Market Cost: 125 million credits

Weapon Systems

1. Laser Batteries (4): These weapon pods are mounted on the top and bottom of the ship (2 each) and are used not only to ward off attackers but also to deal with meteorites and space debris.

Primary Purpose: Anti-ship

Secondary Purpose: Defense

Mega-Damage: 3D6x10 M.D. per blast.

Rate of Fire: Equal to the number of combined hand to hand attacks of the gunner.

Effective Range: 1 mile (1.6 km)

Payload: Effectively unlimited.

2. Missile Batteries (4): These batteries fire medium-range missiles.

Primary Purpose: Anti-ship

Secondary Purpose: Defense

Mega-Damage: Varies with missile type.

Rate of Fire: One at a time or volleys of four or eight.

Effective Range: About 40 miles (64 km)

Payload: 96; 24 missiles per battery.

3. Other Weapon Systems can be added at the purchaser's own expense, but may classify the ship as a "military" vessel and be denied access to many spaceports.

Phase World

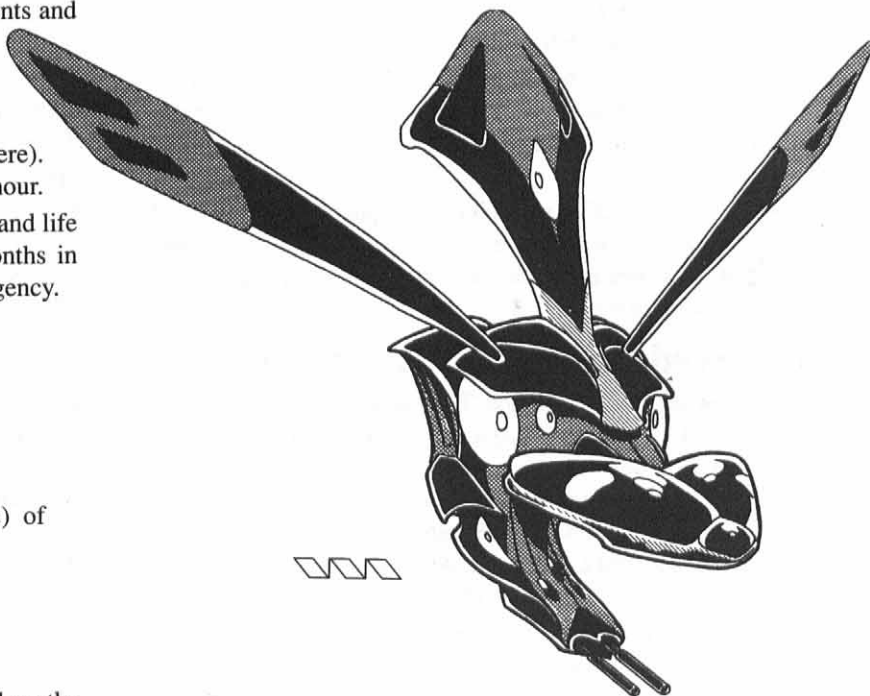

Campaign Ideas

By C.J. Carella & Kevin Siembieda

Having a good idea of what the campaign will deal with is very useful to Game Masters and players alike. The choice of O.C.C.s and R.C.C.s will be influenced by the campaign's "theme." A cosmo-knight may not be appropriate for a space colonization campaign unless there were some hidden or not so hidden, danger's. A repo-bot probably wouldn't fit well with a group of heroic adventurers and so on. Outlined below are some basic campaign themes and ideas. The list covers only *some* possible plots and story elements. Game Masters can mix and match different campaign ideas (a trader/runner campaign could be mixed with a freedom fighter campaign, for instance), add their own twists, or come up with their own plots and ideas. Over time, a campaign can evolve to have several different themes. For example, a freedom fighter campaign might change into a cosmic campaign if the player characters somehow gain a great deal of power and/or experience. At any point it could turn into a transdimensional campaign as the heroes travel to other regions of the Megaverse. Rifts Earth may be a major element, minor subplot or have nothing to do with the stories of adventures in the Three Galaxies or elsewhere.

Exploring the Unknown Campaign

The CCW has the Consortium Discovery Corps, a special branch of the Consortium Armed Forces that travels to uncharted areas of the Three Galaxies and beyond, seeking contacts with new life forms and new cultures. The CDC has two types of basic missions: Short-term troubleshooting and long-term exploration. The first one involves a small team of specialists that make

Star Ships

The truly huge battleships, cruiser, and starships can have anywhere from 12,000 to 40,000 M.D.C. (plus variable force fields) and two to ten times the weapons listed for the smaller vessels previous described. This is in addition to squadrons of space fighters, military shuttle craft, robots, troops and other defensive and offensive resources.

planetary surveys to ensure the world is appropriate for colonization. The long-term explorers travel through uncharted areas of the Three Galaxies, sending probes to diverse star systems in search of potential worlds. Individual prospectors/explorers also travel to far-off regions, sometimes venturing beyond the Three Galaxies and going to other galaxies.

In this campaign, each adventure could deal with a new alien species or world, ranging from mysterious ruins to strange beings that can befriend or threaten the player characters and perhaps the galaxy.

Useful O.C.C./R.C.C.s: Colonists, Spacers and all CAF O.C.C.s would fit into this type of campaign. Check out **Aliens Unlimited** for a hundred different alien races and monsters that could fit easily into this setting.

The Freedom Fighter Campaign

This campaign is set in the Transgalactic Empire and the newly formed Free World Council (FWC). The kreeghor controlled Empire is beset by a civil war. The characters are rebels or rebel sympathizers, doing their best to overthrow their kreeghor overlords and minions. While doing so, they not only have to deal with the Imperial Legions but with the politics of the different rebel factions, many of which have conflicting agendas.

Many different themes can be played in this campaign, from open space warfare between the Imperial and FWC fleets, to espionage and sabotage on Imperial controlled worlds. Either is likely to include intrigue and betrayal among the leading ranks of the rebellion and possibly the kreeghor.

Another angle may be that the CCW is covertly aiding the rebels (as are the Splugorth), for their own reasons. Both sides expect things in return for their aid. Adventures can take the characters to other parts of the Three Galaxies, including Phase World, where weapons and information can be easily purchased and evil plots are always afoot.

Useful O.C.C.s/R.C.C.s: Freedom fighters, runners, CAF fleet officers, cosmo-knights, and any R.C.C. native to the Empire. From other Rifts Sourcebooks: Headhunters, borgs, juicers, spies, special forces soldiers, wilderness scouts, psychics, and other mercenaries and men at arms. Psionic and magic-using characters and just about any character would also fit into this scenario.

The Cosmic Campaign

This would basically be a high-powered campaign with lots of action, travel and danger on a major scale. The player characters could be any O.C.C. or R.C.C. from the common to the rare (temporal raiders, cosmo-knights, True Atlanteans, zembahk and even super heroes). If the adventure is truly cosmic, with the fate of a world(s) or even a galaxy in the balance, the characters are likely to be an improbable collection of rare and powerful beings (perhaps including adult dragons, godlings and gods; G.M.'s choice).

The Game Master and players should determine such things as why is each character interested in fighting evil, how did they band together (this could be done in the course of the first adventure) and why did they decide to stick together? The characters could operate from a starship, or might have a base of operations on some planet. Phase World is ideal, since it is the biggest communication hub in the Megaverse. A cosmic cam-

paign can easily be combined with a transdimensional campaign, with the party traveling to different worlds to track down their enemies and foiling their plots.

The Splugorth can make good villains for a cosmic campaign. Their civilization is very ancient, powerful, and steeped in evil and mystery. However, even cosmic-powered characters will not be able to defeat them in a head-on clash. Just because the characters are powerful doesn't mean they cannot be devious as well. If the characters could trick different Splugorth factions into fighting each other, they might do more damage than by direct attacks. Other possible enemies include the Mechanoids, gene-splicers, vampires and their supernatural masters, evil gods and their minions, and even "normal" villains like space pirates, slavers and assassins. As always, the G.M. is invited to create his own diabolical villains and cosmic story-lines.

This type of campaign can be a lot of fun, but it can degenerate into mindless "slugfest of the week" games, so be careful, unless you're looking for a slugfest (which can be fun too). Just remember, being a hero does not always involve combat. Cosmic defenders might also have to deal with plagues, natural disasters, and other impersonal threats. Or be called upon to show compassion and leadership.

Useful O.C.C.s/R.C.C.s: Cosmo-knights, noro mystic warriors, promethean phase adepts, Quatoria, the forge-born. From other Rifts Sourcebooks: Atlantean undead slayers, azverkan Knights, cyber-knights, dragon hatchlings, holy terrors, godlings, demigods, ramen, phoenixi, any magician O.C.C.s and just about anybody with the courage to accept the challenge to help others!

The Phase World Campaign

In this case, the setting, not the situation, dominates the campaign. Everything comes to Phase World. Many people and things, good and evil, stay there to rub shoulders with heavyweights from around the Megaverse. The player characters can be visitors or "locals." Locals are people who have stayed in Center for several years and have learned many of its mysteries and secret but never all of them. They may hang out at local bars to exchange gossip, aid, or sell information, and cheat or otherwise deal with visitors. Or they can be members of the security forces on one of the many levels and sections of the city, trying to minimize trouble and danger to their area of the city.

Alternatively, the player characters could be new arrivals to Phase World, either by accident (i.e. they were two steps ahead of an angry dragon and impulsively jumped into a Rift) or by design, seeking a city of wonder and opportunity. Or even just making an overnight stop; on Phase world, adventures can happen in the blink of an eye and take characters in any direction. The characters can encounter just about anybody, anywhere, at any time on this multi-dimensional world, including old enemies, pirates, thieves, con-men, gun runners, rebels, assassins, cultists, predatory monsters, slavers, supernatural menaces, Minions of Splugorth, dragons, heroes, soldiers, and gods, to name just a few!

Any type of adventure is possible! Adventures can involve exploring various parts of the city or carry the characters to other worlds!! Even locals can "step" out through one of the dimensional gates and take a trip to other realms. Espionage, assassinations and political intrigue happen all the time. Strange creatures

often Rift into the lower city levels (sometimes even at the main "gates" as depicted on the cover) and some may be powerful enough to threaten the entire city! Old bounty hunters, or enemies of the player characters or any of the city residents may arrive on Phase World seeking revenge against somebody and our heroes are drawn in one way or another (accidentally trying to help, hired as bodyguards, fighting an old foe, etc.). Phase World also offers excellent opportunities to make new enemies, as well.

Or the characters may have come to Phase World to travel to another world or dimension. The people and places presented in **Wormwood**, **Heroes Unlimited**, **Aliens Unlimited**, the **Rifts books** and any of the Palladium games, from **Palladium** to **Robotech**, and more, are waiting to be discovered and explored. The possibilities are truly endless!

Useful O.C.C.s/R.C.C.s: Any character type could end up in Phase World, from dog-boys and dragon hatchlings to city rats and mercenaries.

The Trader/Runner Campaign

In this campaign, the player characters are spacers or involved with spacers who travel from world to world, carrying assorted cargoes and selling them to the highest bidder. This campaign will probably revolve around the travels of an independent ship. The traders can buy goods on a planet where they are cheap and plentiful and fly to an area where they are rare. Smugglers would take their wares to places where they are illegal, for higher prices but at a higher risk. Or the ship owners can "rent" their ship to carry cargo or passengers on demand.

Adventures will deal with who or what the ship is carrying, where it is going, who wants the cargo (which may be somebody other than the purchaser), avoiding pirates and other dangers, and so on. Again, anything is possible. Maybe one or two of the passengers turn out to be spies, assassins, freedom fighters, wanted criminals or refugees and events involving their presence lead the ship and our heroes into adventure and intrigue. Perhaps the cargo of "computer parts" they were taking to a dictatorial planet is actually a bomb, or contraband and the characters are arrested. Now, they have to escape and either prove they are innocent (by capturing the real culprits) or recover their confiscated ship and get out of there (which may make them hunted criminals). Encounters with castaways, derelict ships, pirates, smugglers, criminals, armed forces, alien races, uglies, dimensional anomalies and other space dangers can always lead to adventure.

This campaign can be combined with a merc campaign to a cosmic one depending on the twists and turns of the plot.

Useful O.C.C.s/R.C.C.s: Any really, but spacers, runners, former members of the CAF or Imperial Legions and space pirates are likely to be involved.

The Merc Campaign

War is a reality in the Three Galaxies. The war between the Transgalactic Empire and Free World Council, the Splugorth and others' attempts at conquest, and countless civil wars on independent planets, or between rival planetary federations or giant interstellar corporations are constantly flaring on and off somewhere. Professional soldiers and stout adventurers willing to fight for pay are always in demand. The largest merc company

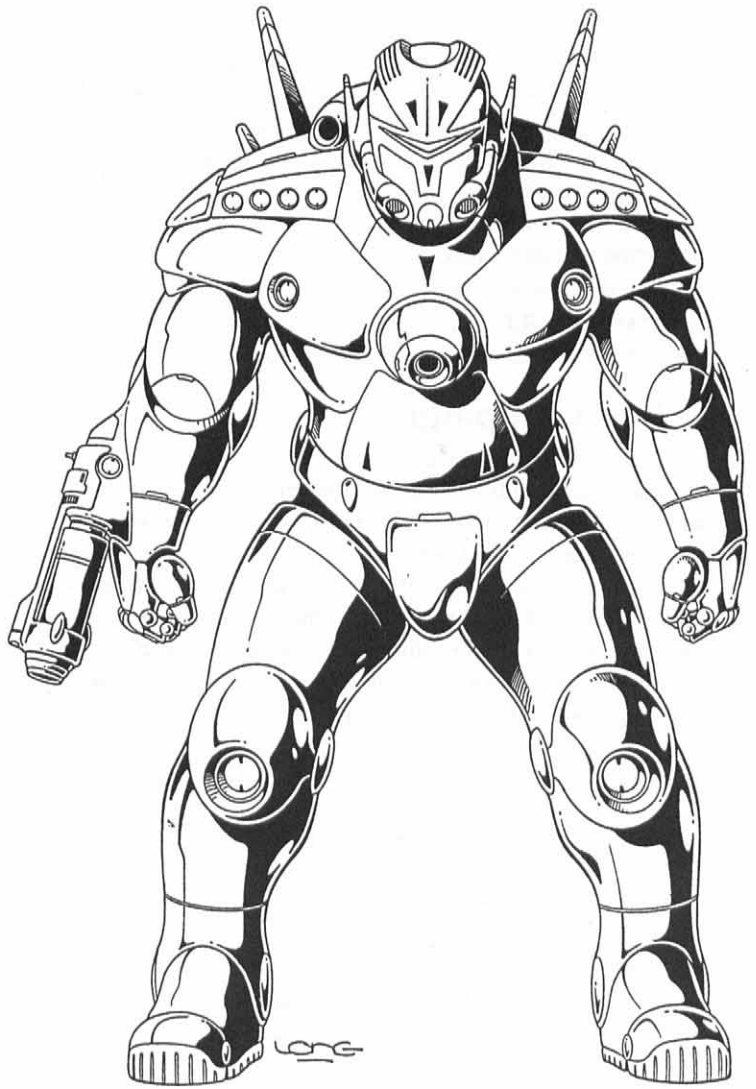

in the Three Galaxies is the **Tri-Galactic Military Services (TMS)**. The player characters could be members of the TMS or have their own small mercenary team available for hire.

The campaign can deal with a number of issues. The military aspect will involve strategy, tactics, and combat, and possibly espionage. The characters may face enemy forces from primitive M.D.C. giants or mystics to well-armed and trained professional armies. Untrustworthy employers can betray the mercs, or lie to them as to the nature of the mission. Many ideas on how to run a mercenary campaign can be found in **Rifts Mercenaries**.

This campaign can be easily combined with a transdimensional or cosmic campaign. Mercs with access to several dimensions will multiply their employment opportunities.

Useful O.C.C.s/R.C.C.s: All military O.C.C.s. and anybody willing to risk their life for a cause or money.

Colonization/Marooned Campaigns

In this campaign, the player characters are colonists or involved with colonists trying to tame a new world. They may be involved in a long-term terraforming project, they may have landed on an apparent paradise, or they could struggle against a hostile environment, monsters or indigenous population. The campaign could be spiced up by introducing complications and dangers not foreseen by the colonists: Pirate raids, the presence

of an unsuspected alien race or technology, or maybe something even more dangerous, like a supernatural intelligence, a tyrannical colony leader, alien invaders, demons, Rift activity, etc.

A variation of this campaign is the “marooned” campaign, where the characters find themselves stranded on an alien planet. This would be a science-fiction version of Robinson Crusoe, with the player characters having to rely on the remains of their vessel/escape pod and whatever tools and weapons they can salvage or manufacture to survive on a strange world.

Useful O.C.C.s/R.C.C.s: Colonists, spacers, scientists, scholars, wilderness scouts, but any can fit depending on the situation.

The Spy Campaign

The rivalries between the CCW, the Transgalactic Empire, the UWW and other worlds sometimes degenerates into border skirmishes and wars, but more often than involves “cold war” tactics: espionage, disinformation, sabotage and even state-sponsored terrorism. In this campaign, player characters are either spies working for one (or, in the case of freelancers or double spies, more than one) side of the struggle or somehow get drawn into this seedy world of double-cross, deception and murder. They can be working undercover, pretending to be members of the enemy’s government or military, smugglers, gun runners, rebel advisors, terrorists, mercenaries, spies and so on. An interesting twist might involve one or two of the player characters or NPCs operating as spies without the rest of the party knowing it. The spies may draw the rest of the group into some serious trouble if they aren’t careful! An espionage campaign should involve deceit, cloak-and-dagger intrigue, suspense and a healthy dose of action/adventure.

Useful O.C.C.s/R.C.C.s: CAF officers, imperial security agents, freedom fighters, changelings, and pleasers. From other Rifts Sourcebooks: The spy, superspy, other mercenaries, Sunaj assassins, dragons, splugorth minions, and city rats.

Transdimensional Campaigns

Phase World, as a “communication hub” for the Megaverse, can be an ideal base of operations for a party of dimension-hoppers. However, this campaign needs to answer a few important questions before they get started. First of all, what is the reason for the party’s desire to travel from world to world? This could involve simple greed (they are a band of transdimensional thieves, con-men, or mercenaries), a desire for justice (in effect, a team of avengers or paladins that try to protect the Megaverse from transdimensional threats), the **Fraternity of the Stars** (described below), on a quest/search for something in particular (person, weapon, magic, knowledge, etc.), simple thrill-seeking, or any number of other reasons. Once the basic goals of the group are defined, this should involve both the G.M. and players, the basic capabilities of the group should be defined. This can be as simple or as complicated as the G.M. and players desire.

There are many transdimensional groups found on Phase World. Mercenary bands often operate from Phase World and sell their services to any world that can afford them, including those in alien dimensions. Transdimensional rogues like the Olympian Club (described in the **Rifts Conversion Book Two: Pantheons of the Megaverse**) sometimes make stops at Phase World to sell their loot, or simply have a good time. Then there

are a number of mystical or religious groups that are trying to find a holy item or even a lost god, and who conduct their search over the entire Megaverse, not to mention dimensional raiders and merchants like Naruni Enterprises and the Splugorth.

Useful O.C.C.s/R.C.C.s: Any really, but one or more skilled dimensional travelers can be extremely helpful, including the shifter, true atlanteans, all the temporal O.C.C.s, many practitioners of magic, prometheans, dragons, godlings and others.

Rifts Earth and Phase World

Rifts Earth is connected to Phase World through several permanent gates. Characters can travel to and from Rifts Earth through those gates as well as through random dimensional Rifts on the lowest and most dangerous levels of the Center. Characters from Rifts Earth could have several reasons for going to Phase World. They might be trying to find unique artifacts or weapons, they might be looking for work, hunting a criminal or refugee, searching for new adventure, popped in by accident, or they could be running from a powerful enemy. By the same token, characters from Phase World could travel to Rifts Earth in search of fame and fortune, to fight the forces of darkness, to sell their services or wares to the highest bidder, to explore a strange new world, escape the law or enemies, or arrive by accident.

The Splugorth operate in both worlds. Enemies of the Splugorth might try to find allies in other dimensions. Or characters from any world could be captured, enslaved and sold at the markets of Splynn (see **Rifts Atlantis**), Cibola (see **Rifts South America**), the slave pens of Phase World, or a number of other places throughout the Megaverse. Escape would leave them stranded in a strange new world.

Naruni Enterprises is another link between Earth and Phase World. Characters trying to discover more about the corporation might travel to Phase World, where the company has a great deal of influence, and where it is not afraid to show its true colors.

Other Palladium Settings

The Palladium RPG: Travelers from the Palladium world would be at a disadvantage if traveling to Phase World, due to the technological gap between the two planets. However, characters who rely on magic or magic weapons may find it easier to make a mark in the Three Galaxies.

Wormwood: The planet Wormwood (described in the **Rifts Dimension Book One**) is a living world beset by murderous demonic beings. The city of *Worldgate* on Wormwood is a transdimensional trading center. Phase World and Worldgate are connected through several gates and trading is common. Warriors and paladins seeking allies against the Unholy might visit Phase World in search of allies. Likewise, some, good and evil, may try to escape the horrors of that world or to spread their ways to other worlds.

The Mechanoids: The murderous cyborg horde are a constant threat to the entire Megaverse. What if they appear in the Three Galaxies? A genocidal war between the Mechanoids and the civilizations of the Three Galaxies can become the backdrop for all types of campaigns, from cosmic struggles to down-and-dirty war stories. The universe of the Mechanoids will be fully developed in an upcoming book, tentatively titled *Mechanoid Space*. G.M.s might want to place the Nigelian Confederation

and Intergalactic Confederation in a nearby galaxy. The CCW is likely to seek diplomatic ties with benevolent civilizations, while the Transgalactic Empire would only seek to conquer them. All those considerations would be rendered moot, of course, if the Mechanoids tried to destroy them all.

Robotech/Macross II: A Rift could bring in any of the major players of the Robotech universe to Phase World or any place in the Three Galaxies. Maybe the SDF-3 appears in this new universe — perhaps followed by an armada of Invid or the Robotech Masters! Or the Marduk might threaten CCW space or strike an alliance with the Transgalactic Empire, or other hostile civilizations. The interaction between the newcomers and the many governments of the Phase World universe can be interesting, besides giving those hotshot Robotech and Valkyrie pilots the chance to go up against an entire new universe of power-

house heroes, villains and dangers.

Heroes Unlimited: Super heroes and space adventures have often mixed well. Characters from a Heroes Unlimited campaign could find themselves dragged to the Phase World setting. Several types of super-powered beings already exist in the Three Galaxies, from the cosmo-knights to the genetically engineered Elite Guards of the Transgalactic Empire.

Aliens Unlimited: As mentioned several times elsewhere, this 192 page sourcebook was written with both *Heroes* and *Rifts* in mind. It offers over 100 different aliens and space monsters, plus other galactic empires, civilizations, lawmen, heroes, powers, weapons, vehicles and adventure ideas. Check it out! It may serve as an excellent addition to the **Phase World** universe and all types of space campaigns.

Adventure

The following is the description of an infamous group of space “runners” to give the reader an idea of the kind of adventure team that can be concocted using **Phase World**. A few adventure ideas follow, but the history and character description should give players ideas as well. Enjoy.

The Stick in Your Eye

The **Stick in Your Eye** is a common sight in the seedier ports of the Three Galaxies, including Phase World. Captain Borshenko and his slick, graceful custom-made ship have a well deserved reputation in the “runner underground” as an excellent, daring and resourceful smuggler with one of the fastest ship in the Three Galaxies. The Stick will take light cargo, people and information anywhere in the Three Galaxies, as long as there is a profit to be made, and the employer isn’t too despicable. Borshenko’s “creative interpretation” of customs laws and import restrictions has made him a wanted man on half a dozen worlds. He has also been condemned to death in absentia in the Transgalactic Empire after a little misunderstanding involving a cargo of smuggled heavy plasma missiles, an overeager Imperial captain, and the subsequent destruction of an Imperial Frigate.

More than actual profit, the crew members of the Stick in Your Eye care about their freedom. They could probably make more money with less danger, working for one of the transplanetary corporations that control much of the space trade routes. Instead, they like having a say what goes on in their lives and enjoy the challenge and excitement. Captain Borshenko is the leader of the group, but each member owns a share of the ship and contracts are accepted or rejected by a vote of every member, including Auntie, the ship’s artificial intelligence computer. After the vote is taken, the leadership is firmly in the hands of Captain Borshenko and First Mate Murray. The rest of the group demonstrates almost military discipline, although nobody is afraid of voicing their opinion.

The group draws the line at two types of activity: They do not deal in slaves, (they hate slavers with a passion) and they don’t perform assassinations, or other “wet work” for anybody.

Captain Bill Borshenko

Human Runner

William Giacomo Borshenko was born on one of the CCW’s Utopia worlds, a planet where crime, pollution and poverty had been eradicated. William was a born rebel and could not stand the rigid social codes of his world. He kept getting into disciplinary problems, despite his high I.Q. and problem-solving skills.

Still, Borshenko would have eventually become a normal citizen, but the planet was attacked by one of the mysterious Ravagers, giant aliens with planetoid-size starships. The rest of the CCW did not even suspect something was wrong, because the planet minimized contact with other worlds, and the Ravagers soon used collaborators to maintain the illusion that nothing was amiss. Not used to resisting authority, most of the population meekly surrendered to slavery. The teenaged Borshenko and rebels like him did not. They established an effective underground that, two years after the Ravagers’ arrival, managed to communicate the planet’s plight to the authorities. A CCW fleet was dispatched and after a massive space battle and bombardment that devastated much of the planet, the Ravagers were killed and the planet was rescued.

To Will’s surprise, the people of his homeworld did not thank him. Instead they blamed him and the resistance for the destruction of their planet. Better to live as slaves, they said, than to endure the upheaval and chaos of liberation. Disgusted by his world, Will left with the CCW fleet and enlisted in the CAF. However, military discipline did not sit well with him. He had no patience for incompetent superiors, and although the CAF is usually very efficient, there are always incompetent and corrupt officers in every army. His talents as a pilot and strategist notwithstanding, he was dishonorably discharged a few years later,

after going all the way to the rank of lieutenant and being busted back down to ensign for diverse charges of insubordination, disrespect to a superior officer, and other offenses.

On his own again, Borshenko threw in his lot with spacers and runners. His skill and training allowed him to make a small fortune in a matter of months. Soon he and some of his associates purchased a ship and went into business on their own.

Alignment: Unprincipled

Attributes: I.Q.: 17, M.E.: 14, M.A.: 20, P.S.: 17, P.P.: 19, P.E.: 17, P.B.: 17, Spd.: 21

M.D.C.: By armor only.

S.D.C./Hit Points: 36 S.D.C. and 46 Hit points.

Horror Factor: n/a

P.P.E.: 6

O.C.C.: CAF Fleet Officer

Level of Experience: 8th level CAF Fleet Officer

Natural Abilities: None

Disposition: Borshenko is self-motivated and prefers to do everything himself. Unlike most officers, he prefers to lead by example and take on the riskiest jobs. As a result, all his crew members respect and care about him. He has a well-deserved reputation as a lady-killer, and he often ends up getting involved with female clients, damsels in distress, and attractive actresses, among others. As one might suspect, these romances often lead to trouble.

Psionic Powers: Minor Psionic: bio-regenerate and deaden pain.

I.S.P.: 36

Magical Knowledge: None

Combat Abilities: Hand to hand: martial arts and boxing.

Attacks Per Melee Round: Six hand to hand attacks.

Bonuses: +1 on initiative, +4 to strike, +7 to parry and dodge, +4 to roll/pull punch, +1 save vs magic, +1 to save vs psionics, +2 to save vs horror factor.

O.C.C. Skills of Note: Detect concealment 83%, intelligence 87%, paramedic 98%, demolition 97%, pilot spaceship 98%, prowl 73% and alien lore 73%. W.P. Energy pistol, energy rifle, heavy energy, power armor combat: basic and fighter pilot: basic.

Alliances and Allies: Besides the crew of the Stick, Borshenko has many contacts with other runners and the galactic black markets. He is also on friendly terms with several adventurers, travelers and spies from several factions of the Three Galaxies, including Phase World (one of his favorite ports).

Transportation: Co-owner of the Stick In Your Eye spaceship.

Weapons: His sidearms of choice are an NE-4P plasma cartridge pistol (1D4×10 M.D.) and a HI-80 laser rifle.

Body Armor: CAF Combat armor (M.D.C. 100).

Money: Has a personal fortune of one million credits in cash, one million in various stocks, plus his investment in the ship.

Description: A muscular human male with blond hair, blue eyes and Nordic features. He constantly changes his appearance from beards to mustaches, to clean-shaven to five o'clock shadow, depending on his mood.

Auntie

Machine People Computer

Unlike most machine people, Auntie does not have a humanoid body. "She" once did, but is now reduced to being the controlling spirit of the Stick In Your Eye.

Auntie has known first-hand the horrors of slavery. Some time ago, she was a pilot in a commercial spaceship. Pirates captured the ship and killed all of her crew members. Despite her best efforts, she was defeated and subdued by the raiders who decided to enslave her. Using a complicated procedure, they removed her robotic "brain" and neutralized many of her natural powers, including the ability to manipulate and rebuild herself. A disembodied computer, Auntie was installed inside a spaceship, using her electronic mind to control the ship's systems. For several years, she labored under the pirates, biding her time. Despite her captors' precautions, she was eventually able to take control of their ship. When she did, she got rid of her tormentors by blowing the airlocks and leaving the pirates to the tender mercies of cold vacuum of space.

The liberated Auntie wandered the spaceways, an intelligent starship that needed no crew to operate. She realized that without humanoid help, the ship — and her — would eventually suffer from disrepair and "die." She struck a bargain with Borshenko and his friends, forming a partnership that has lasted for years. Borshenko "purchased" the ship by providing repairs and enhancements. The modified ship, renamed **The Stick In Your Eye**, became the runner ship that is now famous throughout the Three Galaxies. Wary at first, Auntie soon struck a fast friendship with the ex-soldier. Borshenko has tried to find a way to release Auntie from the starship, but so far nobody has been able to undo the damage the pirates inflicted on her. Over the years, Auntie has become used to being a starship. Under her guidance, The Stick is a living ship, able to outperform other vessels.

Alignment: Unprincipled.

Attributes: Most physical attributes are meaningless. I.Q.: 30, M.E.: 20, M.A.: 22. Her melding with the ship's computers has increased her intelligence beyond the limits of her race.

M.D.C.: Her housing unit has 400 M.D.C. Destroying the starship might cause enough shock to destroy her mind (1-21% chance).

Horror Factor: 10 for people who realize she is a sentient starship (a rarity in the Three Galaxies).

P.P.E.: Zero

O.C.C.: Machine People R.C.C. (altered)

Level of Experience: 10th level

Natural Abilities: Instead of the normal machine people powers, Auntie has become one with the starship she controls. All the vessels' sensors, weapon systems and computing power are at her disposal. She usually pilots the ship, doing so with uncanny speed and ability.

Disposition: Auntie sees herself as the surrogate parent of the crew. Her holographic persona is always there for anybody to ask of her advice, help, or looking for a virtual shoulder to cry on. The sentient ship is usually shy and distrustful towards strangers. She tends to dislike all of Borshenko's love interests, perhaps because she has developed a crush on the captain. Auntie has no patience for sloppiness and carelessness.

ness aboard the ship. People who do not clean up after themselves will get on her bad side in a hurry.

Psionic Powers: None

Magical Knowledge: None

Combat Abilities: Special

Attacks Per Melee Round: Eight ship attacks per melee round.

Damage: Varies with weapon system. See *The Stick In Your Eye*, below.

Bonuses: +3 on initiative, +9 to strike, +10 to dodge, +3 to save vs magic and psionics, +6 to save vs horror factor, impervious to disease, gases and other maladies that afflict humans.

Vulnerabilities/Penalties: Auntie has no physical body outside the starship. She can project holographic projections of herself up to one mile (1.6 km) away from the ship, but these are insubstantial phantoms that cannot affect the world in any way other than by producing light and sounds.

O.C.C. Skills of Note: Astrophysics 98%, navigation: space 98%, read sensory equipment 98%, computer operation 98%, computer programming 95%, xenology 95%, streetwise 62%, lore: aliens 98%, and piloting: starship 98%.

Transportation: Auntie is her own transportation.

Weapons: See *The Stick In Your Eye's* weapon systems.

Appearance: Auntie's holographic projection appears as an attractive (P.B. 14), mature human female with short black hair and black eyes.

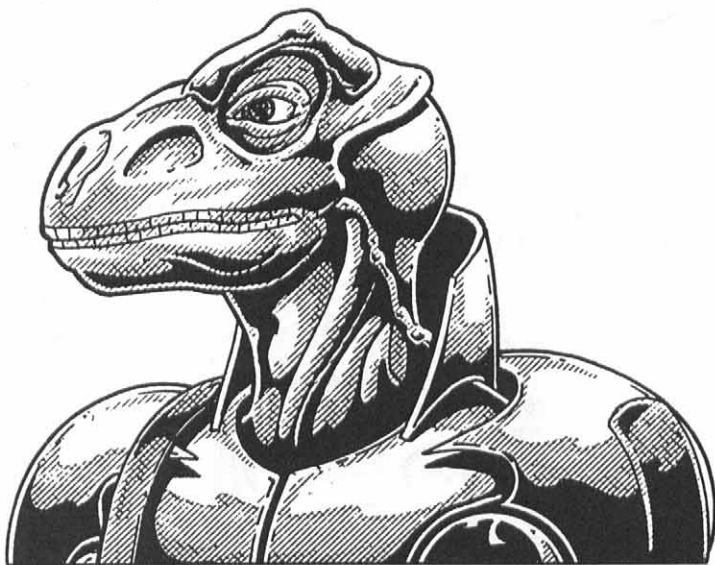

Murray

Seljuk First Mate

Murray is a reformed criminal, a seljuk that was facing life imprisonment in a Transgalactic Empire's mining colony for murdering an Imperial Security Agent. The funny thing was, Murray didn't even know the human he killed was an Imperial agent; he just thought he had been cheated at a card game and reacted accordingly. A child of the slums of a large Imperial city, Murray lived in a world where kill or be killed was the only law, and where crime was the only escape from poverty. His strength and near-invulnerability made him an ideal enforcer and he soon became a killer-for-hire, until his capture and sentencing.

The seljuk had never had a friend, until he met Borshenko at the penal colony. Borshenko, after a rash of bad luck, had ended

up in the Imperial prison (fortunately, this was before the Empire condemned him to death). All it took was an act of kindness, the sharing of some rations after Murray was punished for disobedience, and the fact that Borshenko treated Murray as a person, not a living weapon. Their ordeal together made them good friends, and they used their skills to engineer a mass prison break. The two became partners and now Murray is *The Stick's* first mate.

Alignment: Anarchist

Attributes: I.Q.: 13, M.E.: 17, M.A.: 14, P.S.: 46, P.P.: 18, P.E.: 22, P.B.: 9, Spd.: 20

M.D.C.: 270

Horror Factor: 11

P.P.E.: 4

O.C.C.: Headhunter

Level of Experience: 7th level Headhunter.

Natural Abilities: Takes half damage from M.D.C. fire and energy attacks (including magical attacks), regenerates 1D6×10 M.D.C. per hour, excellent sense of smell.

Disposition: Murray is slowly learning about trust and friendship. At first, he considered *only* Borshenko to be his friend and saw everyone else as a potential enemy. Over the years, he has grown accustomed to the other crew members, especially Auntie, who is the only parental figure he has ever known, and Laurana, who always treats him with kindness and respect. When dealing with hostile strangers, Murray reverts to his street-bred enforcer days, and becomes bullying and intimidating. He will do anything to protect his teammates, including killing anyone.

Psionic Powers: None

Magical Knowledge: None

Combat abilities: Hand to hand: expert, boxing and wrestling.

Attacks Per Melee Round: Five hand to hand attacks per melee.

Bonuses: +2 on initiative, +4 to strike, +7 to parry and dodge, +4 to roll/pull punch, and +7 save vs magic.

O.C.C. Skills of Note: Basic radio 95%, detect ambush 75%, detect concealment 75%, tracking 70%, weapon systems 85%, pilot starship 83%.

Weapons: Owns a power halberd, a HI-80 laser rifle, and an assortment of heavy energy weapons.

Body Armor: Modified suit of Kittani Explorer Armor: M.D.C. 85.

Money: Personal fortune of 500,000 credits in addition to his weapons and possessions.

“Bug” Vacuum Wasp Pilot

This fearsome creature is one of the best-known crew members of the *Stick*. Bug is a Vacuum Wasp, one of the insectoid creatures that populate the *Star Hives* (see the *Star Hives section* for details). Rumor has it that Bug is Borshenko's “pet monster” and that the captain found him as a hatchling and raised him to adulthood. In reality, Bug found Borshenko and *The Stick In Your Eye* at a time when they desperately needed help.

Bug had been the sole survivor of a *Star Hive* that was obliterated by a Kittani fleet. Freed from the mind control of the *Hive Queen*, Bug sought the companionship of other sentient beings. The first people he ran into were none other than Borshenko and his crew. *The Stick In Your Eye* had been disabled by Kittani fighters from the same armada that had destroyed his home. The

Stick, its propulsion system crippled, was dead in space as the Kittani fighters moved in for the kill. Bug attacked the ships, damaging two of them and giving the Kittani something else to shoot at while the crew of the Stick jury-rigged the ship's systems. When the Stick was back on-line, Borshenko rushed to the aid of the Vacuum Wasp, destroying the raiders. Bug, who had been severely wounded in the fight, was rescued and adopted by the runner crew.

Alignment: Aberrant

Attributes: I.Q.: 11, M.E.: 10, M.A.: 16, P.S.: 21, P.P.: 22, P.E.: 18, P.B.: 6, Spd.: 23 running, Mach 6 in an atmosphere, Mach 10 in space.

M.D.C.: 200 plus N-F50A Force Field (M.D.C. 160).

Horror Factor: 10

P.P.E.: 11

Level of Experience: 7th level Vacuum Wasp.

Natural Abilities: Multi-spectrum vision equivalent to cybernetic multi-optic eye and radar (range 2000 feet/610 m). Regenerates lost limbs and M.D.C. at the rate of 1D4×10 M.D.C. per 8 hour rest period. He is able to psionically recognize members of his own Hive and attacks all others as instinctive enemies.

Supersonic Flight: Can fly at up to Mach 6 in an atmosphere, Mach 10 in space.

Bio-electric Blast: The Vacuum Wasp can generate electricity and fire electrical blasts inflicting 3D6 M.D. at level one plus 1D6 per additional level. Range: 4000 feet (1200 m)

Disposition: Bug, like all Star Wasps, is eerily quiet. The 12-foot long creature ignores everybody beside crew members and rarely speaks. Bug has the closest rapport with the ship itself. He considers The Stick to be its new hive and Auntie to be the Hive Queen!

Psionic Powers: See aura, see the invisible, sense magic, and mind-block auto-defense. Plus telepathy that costs no I.S.P. but only works between Hive members. I.S.P.: 160

Magical Knowledge: None

Combat Abilities: Natural

Attacks Per Melee Round: Six hand to hand attacks per melee.

Bonuses: +2 on initiative, +9 to strike, +9 to parry and dodge, +2 to dodge while flying (total +7 to dodge), +2 to roll/pull punch, +2 to engage in dog-fighting, +4 save vs magic, and +6 to save vs horror factor.

Vulnerabilities/Penalties: Takes double damage from psionic attacks.

O.C.C. Skills of Note: Navigation: space 80%, pilot starship 78%, weapon systems 80%, and W.P. energy rifle.

Laurana and Borshenko had a brief affair shortly after she joined the crew. The pressures of being partners and lovers, Auntie's meddling, and mutual stubbornness, all contributed to breaking them up. There is still a great deal of attraction between them and this sometimes causes tension on the ship, especially when Borshenko becomes involved with yet another woman.

Alignment: Unprincipled.

Attributes: I.Q.: 22, M.E.: 21, M.A.: 19, P.S.: 11, P.P.: 17, P.E.: 25, P.B.: 17, Spd.: 25

M.D.C.: By body armor or magic.

S.D.C./Hit Points: 120 S.D.C. and 49 Hit Points

Horror Factor: None

P.P.E.: 140

Level of Experience: 8th level alien temporal warrior

Natural Abilities: Laurana's race has nightvision 200 feet (60 m), and heightened mental abilities and physical endurance.

Disposition: Laurana is a sensitive and gentle woman who hides beneath a tough and boisterous facade. She rarely says a kind word to anybody, but somehow she always manages to help her team-mates whenever they need help (and the crew recognizes this). Her rough humor never offends her friends. Laurana secretly despises violence, although people who know her superficially would never believe it. Although she will always do what is necessary, she often finds a way to deal with problems without firing a shot.

Psionic Powers: None

Magical Knowledge: Temporal magic (see **Rifts England**): D-phase, wink-out, dimensional pockets, see dimensional anomaly, s-dep, t-dep, time warp: age, time warp: fast forward, time warp: slow motion. Common magic: globe of daylight, tongues, see the invisible, detect concealment, armor of Ithan and invulnerability.

Combat abilities: Hand to hand: martial arts and boxing.

Attacks Per Melee Round: Four hand to hand attacks or two by magic.



Laurana

Female Alien (Temporal Warrior)

Laurana, an exotically beautiful alien, is the only crew member who is not native to the Three Galaxies. She is actually a D-Bee from parts unknown. She arrived on Phase World as the slave-warrior of a visiting temporal raider. Laurana managed to escape her owner and earn enough money as a freelance mercenary to buy herself a share of The Stick in Your Eye. Her magical abilities have been very useful to the runner team, and her knowledge of strange cultures and alien worlds has proved invaluable in the past.

Bonuses: +1 on initiative, +4 to strike, +7 to parry, +7 to dodge, +5 to roll/pull punch, +1 save vs magic, +3 to save vs psionics, +5 to save vs horror factor.

O.C.C. Skills of Note: Prowl 88%, pick locks 88%, land navigation 96%, wilderness survival 88%, swimming 98%, climbing 88%, sniper, basic math 98%, demon and monster lore 73%, speaks American, Trade One, Four and Five, Demongolian and Dragonese, Elf, all at 98%.

Weapons: Usually carries a Kittani plasma ejector (6D6 M.D.) and a K-EP pump pistol (5D6 M.D.).

Body Armor: Techno-wizard body armor (M.D.C. 80) with armor of Ithan enchantment (60 M.D.C.).

Money: Has 200,000 credits in cash.

“Tiny Tim”

Promethean Science & Medical Officer

Like many members of the Promethean race (see R.C.C. description), Gannell A’Krytop (commonly known as “Tiny Tim”) is on a journey of discovery and learning. Gannell first became involved with the Stick and its crew as a client. He had hired the ship to transport a number of ancient artifacts he had found during an archeological expedition. The artifacts were magical items of great power and Gannell and the Stick’s crew were pursued and attacked by a gang of thieves and assassins hired by a powerful lord from the United Worlds of Warlock. At the end of the harrowing trip, and after paying Borshenko his fee (with a hefty bonus for the hazards incurred in the trip), Gannell asked if he could join the crew. After witnessing the Promethean’s quiet efficiency firsthand, the crew was glad to have him.

Since then, Gannell/Tiny Tim has grown to be one of the most trusted and respected members of the crew. His intelligence and knowledge has saved the crew from many dangerous situations and his phase abilities have come in handy in many tight spots. Between him, the hulking Murray, and the gigantic Bug, the Stick’s crew is one of the most intimidating bands in the Three Galaxies.

Alignment: Scrupulous

Attributes: I.Q.: 24, M.E.: 19, M.A.: 21, P.S.: 28, P.P.: 11, P.E.: 25, P.B.: 8, Spd.: 11

M.D.C.: By body armor or magic only.

S.D.C./Hit Points: 523 S.D.C. and 161 Hit Points.

Horror Factor: 10

P.P.E.: 110

Level of Experience: 8th level Promethean

Natural Abilities: See the promethean R.C.C. description elsewhere in this book. Doesn’t breathe air, immune to radiation and normal heat and cold. Can see in total darkness, and has eagle-like normal vision, and phase powers as per R.C.C.

Disposition: Gannell is in a constant state of friendly curiosity. He loves to examine and investigate any riddle or mystery that comes his way. Sometimes this gets him and his companions in trouble. Despite his intimidating appearance, Gannell is a skilled diplomat and knows how to put people at ease, so he often handles potential customers and local authorities.

Psionic Powers: Astral projection, clairvoyance, deaden pain, empathy, object read, induce sleep, levitation, psychic diagnosis, psychic purification, psychic surgery, summon inner strength, telepathy, total recall and mind block auto-defense. Plus any three powers from the Healing, Sensitive or Physical

categories. Add one more power from any of these three categories every level after the first.

I.S.P.: 175

Magical Knowledge: None

Phase Powers: D-shift ghost, dimensional leap, multiphase and phase field.

Combat Abilities: Hand to hand: basic

Attacks Per Melee Round: Three hand to hand or psionic or phase attacks/actions per melee.

Bonuses: +1 on initiative, +1 to strike, +2 to parry, +2 to dodge, +2 to roll/pull punch, +11 save vs magic, +5 to save vs psionics, +8 to save vs horror factor.

Vulnerabilities/Penalties: Takes double damage from phase and magic weapons.

O.C.C. Skills of Note: Language and literacy: Promethean 98%, language and literacy: trade two, trade four, and trade five, all at 95%. Basic and advanced math 98%, archeology 85%, biology 95%, botany 90%, chemistry 95%, computer operations 98%, analytical chemistry 90%, medical doctor 98%, pathology 95% and phase technology 95%. W.P. energy rifle and energy pistol.

Other Crew Members

- Terry O’Connol (sensors): 7th level human spacer
- Hofra Rurgh (mechanic/engineer): 6th level Wolfen spacer
- Janet Lee: 5th level human spacer.
- The Stick can accommodate as many as 25 crew members and passengers; sometimes new crew members are hired for short-term missions.

The Stick in Your Eye

This unique vessel is a converted military scout ship. Its frame has been customized to allow for greater cargo space while keeping the vessel’s scout speed and maneuverability. The ship is sleek and dangerous looking, with a needle-like profile broken up by the cargo/crew compartment which is round and tear-drop shaped. The twin contragravity engines on each side resemble horns, which may indicate a kreeghor design. Since finding the ship and its sentient computer (see Auntie, above), Captain Borshenko has spent millions of credits outfitting it with the best weapons, defenses and stealth systems money can buy. The ship can outrun all large vessels, and outgun most fighters. Since Auntie serves as the pilot and gunner, the Stick can maneuver like a living being, and often surprises enemies.

The ship can hold up to 100 tons in cargo, so to make a profit only very valuable commodities can be carried. Typical cargoes include exotic perfumes and spices, alien animals and plant samples, weapons, complex machinery, valuable gems and artifacts, and important passengers.

Model Type: SIYE-19

Class: Converted Scout/Runner Vessel

Crew: Nine, plus up to 11 additional crew or passengers.

M.D.C. by Location:

Main Laser Cannons (2) — 500 each

GR-Cannon (Nose) (1) — 200

Mini-Missile Launchers (4) — 100 each

Heavy Missile Launcher (1, underside) — 200

Variable Force Field — 200 per side (1200 total)

Bridge — 1,000

* Main Body — 4,000

** Main Engines (2, on the sides) — 1,000 each

* Depleting the M.D.C. of the main body shuts the ship down, causing it to drift in space. The secondary weapon turrets have independent power supplies, however, and can fight on. If the ship is reduced to -1,000 M.D.C., it blows up, causing 1D4×1000 M.D. to anything in a 300 foot (91.0 m) area.

** Destroying one engine reduces maximum speed by half and maneuverability is diminished. But with Auntie at the helm, there is only a -1 penalty to all dog-fighting rolls. Destroying both engines will leave the ship dead in space, flying at its current speed without any way to stop or maneuver until the engines are repaired or jury-rigged.

Speed:

Driving on the ground: Not possible.

Flying: Mach 9 in space (maximum speed). Or up to Mach 2.5 in an atmosphere. Cruising speed is Mach 3-4.

Star Drive: Gravitonic drive, maximum speed: 5 light years per hour.

Range: Effectively unlimited. Carries enough life support and supplies (including hydroponic garden) for one year of uninterrupted travel (could be stretched to two years in an emergency).

Statistical Data:

Height: 40 feet (12.2 m) at the “tear drop” section.

Width: 40 feet (12.2 m) at its widest, plus the twin engines add a “wingspan” of 80 feet (24.4 m)

Length: 200 feet (61 m)

Weight: 800 tons, plus up to 100 tons of extra cargo.

Cargo: Cargo hold is 30 feet (6 m) tall, 30 feet (6 m) wide and 50 feet long (61 m), providing 1,000 square feet and 20,000 cubic feet of space. Maximum cargo weight is 100 tons. Does not include normal complement of supplies and equipment.

Power System: Anti-matter, average energy life of 40 years.

Weapon Systems

1. Main Laser Cannons (2): These military-issue guns are mounted on the sides of the ship and are powerful enough to damage large vessels. They are too big to engage small fighters effectively, however (fighters, robots and power armor are at +5 to dodge their attacks).

Primary Purpose: Anti-ship.

Mega-Damage: 1D4×100 M.D. per blast, or 2D4×100 M.D. per double blast.

Rate of Fire: Equal to number of hand to hand attacks of the gunner.

Effective Range: 10 miles (16 km)

Payload: Effectively unlimited

2. GR Cannon: Mounted on the needle-like nose of the ship is a medium gravity cannon used to engage fighter ships and other small targets.

Primary Purpose: Anti-spacecraft

Secondary Purpose: Defense.

Mega-Damage: A burst is 20 rounds and inflicts 3D6×10 M.D. Can only fire bursts.

Rate of Fire: Equal to the number of combined hand to hand attacks per melee.

Effective Range: 5 miles (8 km)

Payload: 4000 rounds; that's 200 bursts. Additional ammo can be brought from the cargo hold (takes 2 minutes with two crew members attending to it).

3. Mini-missile Launchers (4): These missile turrets are distrib-

uted to cover the entire ship, providing cover against incoming attackers.

Primary Purpose: Anti-spacecraft

Secondary Purpose: Defense

Mega-Damage: Varies with missile type. Usually carries plasma missiles (1D6×10 M.D.).

Rate of Fire: One at a time or in volleys of 2, 4, 8 or 12 per launcher.

Effective Range: About 2 miles (3.2 km) in space.

Payload: 192; 48 per launcher.

4. Heavy Missile Launcher: Mounted in the underside of the main body is a heavy missile launcher.

Primary Purpose: Anti-spacecraft

Secondary Purpose: Defense

Mega-Damage: Varies with missile type.

Rate of Fire: One at a time or in volleys of 2, 4 or 8 missiles.

Effective Range: About 1000 miles (1600 km).

Payload: 48 missiles.

5. Stealth Systems: Besides having military-grade sensors, the *Stick* has advanced stealth systems to mask the ship's signature. All sensor rolls to detect the ship are at -50%, it has engaged its contragravity system (i.e., is flying), or at -80% if the ship is floating adrift with all systems down.

Adventure Ideas

Stowaways: The player characters find themselves trying to leave a planet in a hurry. Maybe the authorities are after them, or perhaps they owe money to the wrong people. Unable to hire a ship, they sneak into one alongside a cargo of exotic animals — right into the holds of the *Stick In Your Eye*. Eventually, they will be discovered. Depending on the situation, Borshenko and his crew may forgive the trespass and even help the characters, or the situation could get ugly. Taking over the ship by force is almost certainly doomed from the start, because Auntie will shut down various systems to capture or eject enemies into space. The adventure might lead to the player characters joining the crew of the ship (at least for a while) or getting themselves involved in trouble that has nothing to do with them, and everything to do with the *Stick* and her crew. In the end, they either make great friends with the crew who they can count on in the future, or dangerous enemies.

Passing the Test: Tiny Tim has come to the time of the Test (see the Promethean R.C.C.) and he needs assistance. Borshenko and his crew will do what they can, but the player characters are in a unique position to help. Depending on what the characters can do, Tiny Tim's test may involve a military mission, a trek to unexplored worlds, or a dangerous quest to save the Three Galaxies from a dangerous threat. During the course of the Test, the two groups may forge friendships and alliances.

Brave New World: Borshenko took one risk too many and his ship was sucked into a Rift! At the other end, the *Stick In Your Eye* finds itself floating in orbit above Rifts Earth! The newcomers can be attacked by the orbiting civilizations described in **Mutants In Orbit**, or they may be forced to crash-land on the planet below. Returning home will probably entail getting help from the locals (the player characters, perhaps?). In the meanwhile, a number of forces, including the Coalition, Naruni Enterprises, the Splugorth or Triax may all take an interest in the ship and its crew. The accident might even lead to the development of a FTL drive on Earth!

Experience Tables

Noro Psychic	Pleasurer & Termite Engineers	Machine People & Phantom	TVIA Agent, CAF Fleet Officer, Imperial Legionnaire	CAF Trooper
Promethean (First Stage)	1 0,000-2,150	Vacuum Wasps	1 0,000-2,100	1 0,000-2,150
1 0,000-2,600	2 2,151-4,300	1 0,000-2,300	2 2,101-4,200	2 2,151-4,250
2 2,601-5,000	3 4,301-8,600	2 2,301-4,500	3 4,201-8,400	3 4,251-8,850
3 5,001-10,000	4 8,601-17,200	3 4,501-10,000	4 8,401-17,200	4 8,851-17,000
4 10,001-20,000	5 17,201-25,500	4 10,001-20,000	5 17,201-25,400	5 17,001-25,000
5 20,001-30,000	6 25,501-36,000	5 20,001-30,000	6 25,401-35,800	6 25,001-35,000
6 30,001-39,000	7 36,001-52,000	6 30,001-42,000	7 35,801-51,000	7 35,001-50,000
7 39,001-52,000	8 52,001-73,000	7 42,001-65,000	8 51,001-71,200	8 50,001-70,000
8 52,001-70,000	9 73,001-98,000	8 65,001-85,000	9 71,201-96,400	9 70,001-95,000
9 70,001-100,000	10 98,001-134,000	9 85,001-110,000	10 96,401-131,600	10 95,001-130,000
10 100,001-140,000	11 134,001-184,000	10 110,001-160,000	11 131,601-181,800	11 130,001-180,000
11 140,001-190,000	12 184,001-240,000	11 160,001-210,000	12 181,801-232,000	12 180,001-230,000
12 190,001-240,000	13 240,001-295,000	12 210,001-285,000	13 232,001-282,200	13 230,001-280,000
13 240,001-290,000	14 295,001-365,000	13 285,001-370,000	14 282,201-342,400	14 280,001-330,000
14 290,001-350,000	15 365,001-425,000	14 370,001-450,000	15 342,401-402,600	15 330,001-400,000
15 350,001-520,000		15 450,001-575,000		
Phase Adept, Time Master & Wolfen Quatoria	Seljuk, Noro Mystic Warrior, Kreeghor, and Catyr	Cosmo-Knight	Space Pirate	CAF Scientist
1 0,000-2,650	1 0,000-2,200	1 0,000-3,000	1 0,000-1,960	1 0,000-2,000
2 2,651-5,300	2 2,201-4,400	2 3,001-5,400	2 1,961-3,950	2 2,001-4,000
3 5,301-11,000	3 4,401-8,900	3 5,401-10,800	3 3,951-8,900	3 4,001-8,300
4 11,001-21,000	4 8,901-18,000	4 10,801-21,600	4 8,901-17,700	4 8,301-16,500
5 21,001-32,000	5 18,001-26,000	5 21,601-31,600	5 17,701-26,700	5 16,501-25,000
6 32,001-42,000	6 26,001-36,000	6 31,601-50,000	6 26,701-35,700	6 25,001-35,000
7 42,001-62,000	7 36,001-52,000	7 50,001-80,000	7 35,701-50,700	7 35,001-50,000
8 62,001-90,000	8 52,001-76,000	8 80,001-120,000	8 50,701-70,700	8 50,001-70,000
9 90,001-120,000	9 76,001-100,000	9 120,001-170,000	9 70,701-95,700	9 70,001-95,000
10 120,001-170,000	10 100,001-150,000	10 170,001-230,000	10 95,701-125,700	10 95,001-130,000
11 170,001-220,000	11 150,001-200,000	11 230,001-300,000	11 125,701-175,700	11 130,001-180,000
12 220,001-290,000	12 200,001-275,000	12 300,001-380,000	12 175,701-225,700	12 180,001-230,000
13 290,001-400,000	13 275,001-350,000	13 380,001-470,000	13 225,701-275,700	13 230,001-280,000
14 400,001-500,000	14 350,001-425,000	14 470,001-600,000	14 275,701-325,700	14 280,001-330,000
15 500,001-700,000	15 425,001-525,000	15 600,001-800,000	15 325,701-375,701	15 330,001-390,000
Phase Mystic	Silhouette, Draconid & Repo-Bots	Freedom Fighter & Imperial Security	Spacer & Colonist	
1 0,000-2,300	1 0,000-2,200	Galactic Tracer, Runner	1 0,000-1,900	
2 2,301-4,600	2 2,201-4,400	1 0,000-2,100	2 1,901-3,800	
3 4,601-9,200	3 4,401-9,000	2 2,101-4,200	3 3,801-7,300	
4 9,201-18,400	4 9,001-19,000	3 4,201-8,400	4 7,301-14,300	
5 18,401-26,500	5 19,001-28,000	4 8,401-17,200	5 14,301-21,000	
6 26,501-36,600	6 28,001-40,000	5 17,201-25,400	6 21,001-30,000	
7 36,601-51,700	7 40,001-60,000	6 25,401-35,800	7 30,001-40,000	
8 51,701-71,800	8 60,001-80,000	7 35,801-51,000	8 40,001-53,000	
9 71,801-96,900	9 80,001-100,000	8 51,001-71,200	9 53,001-73,000	
10 96,901-137,000	10 100,001-150,000	9 71,201-96,400	10 73,001-103,000	
11 137,001-188,100	11 150,001-200,000	10 96,401-131,600	11 103,001-138,000	
12 188,101-229,200	12 200,001-275,000	11 131,601-181,800	12 138,001-188,000	
13 229,201-279,300	13 275,001-350,000	12 181,801-232,000	13 188,001-238,000	
14 279,301-340,400	14 350,001-425,000	13 232,001-282,200	14 238,001-288,000	
15 340,401-400,000	15 425,001-525,000	14 282,201-342,400	15 288,001-328,000	
		15 342,401-402,600		

RIFTS[®] Phase World: TM Character Sheet

Hand To Hand	Ancient Weapons/W.P.s	Strike	Damage	Parry	Throw
Type: _____	_____	_____	_____	_____	_____
Number of Attacks: _____	_____	_____	_____	_____	_____
Damage: + _____	_____	_____	_____	_____	_____
Strike: + _____	_____	_____	_____	_____	_____
Parry: + _____	_____	_____	_____	_____	_____
Dodge: + _____	_____	_____	_____	_____	_____
Roll: + _____	_____	_____	_____	_____	_____
Initiative: + _____	_____	_____	_____	_____	_____
<i>Damages</i>	W.P. Archery & Targetting	Strike	Damage	Range	Rate of Fire
Punch: _____	_____	_____	_____	_____	_____
Kick: _____	_____	_____	_____	_____	_____
Jump Kick: _____	_____	_____	_____	_____	_____
Flip: _____	_____	_____	_____	_____	_____
<i>Special Attacks</i>	Modern Weapons/W.P.s	Strike	Damage	Range	Payload
Knock Out: _____	_____	_____	_____	_____	_____
Critical Strike: _____	_____	_____	_____	_____	_____
Death Blow: _____	_____	_____	_____	_____	_____
<i>Other Stats</i>	_____	_____	_____	_____	_____
M.D.C.: _____	_____	_____	_____	_____	_____
S.D.C./H.P.: _____	_____	_____	_____	_____	_____
Body Armor: (_____)	_____	_____	_____	_____	_____
M.D.C.: _____	_____	_____	_____	_____	_____

Robot/Power Armor	Robot/Power Armor	Vehicle Log	Vehicle Log
Type: _____	Type: _____	Type: _____	Type: _____
Number of Attacks: _____	Number of Attacks: _____	Crew: _____	Crew: _____
Damage Bonus: + _____	Damage Bonus: + _____	Cruise Speed: _____	Cruise Speed: _____
Strike Bonus: + _____	Strike Bonus: + _____	Max Speed: _____	Max Speed: _____
Parry Bonus: + _____	Parry Bonus: + _____	Max Range: _____	Max Range: _____
Dodge Bonus: + _____	Dodge Bonus: + _____	Size: _____	Size: _____
Roll Bonus: + _____	Roll Bonus: + _____	Weight: _____	Weight: _____
Damage	Damage	Number of Attacks: _____	Number of Attacks: _____
Restrained: _____	Restrained: _____	M.D.C. by Location	M.D.C. by Location
Punch: _____	Punch: _____	Main Body: _____	Main Body: _____
Power Punch: _____	Power Punch: _____	Pilot: _____	Pilot: _____
Kick: _____	Kick: _____	_____	_____
Leap Kick: _____	Leap Kick: _____	_____	_____
_____	_____	_____	_____
Speed	Speed	Weapons Systems	Weapons Systems
Land: _____	Land: _____	_____	_____
Running: _____	Running: _____	_____	_____
Flying: _____	Flying: _____	_____	_____
Space: _____	Space: _____	_____	_____
_____	_____	_____	_____
M.D.C. by Location	M.D.C. by Location	Notes: _____	Notes: _____
Main Body: _____	Main Body: _____	_____	_____
Head: _____	Head: _____	_____	_____
Arms: _____	Arms: _____	_____	_____
Legs: _____	Legs: _____	_____	_____
_____	_____	_____	_____
Notes: _____	Notes: _____	_____	_____
_____	_____	_____	_____
_____	_____	_____	_____
_____	_____	_____	_____

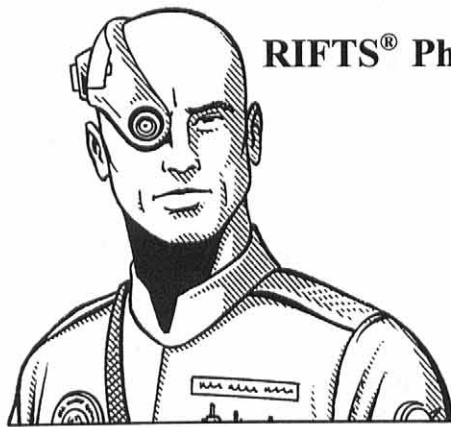

RIFTS[®] Phase World: CAF Scientist O.C.C.[™]

Name: _____
 Alignment: _____
 M.D.C.: _____ Horror Factor: _____
 S.D.C./Hit Points: _____
 Level: _____ Experience: _____
 O.C.C.: _____
 Savings: _____

O.C.C. Skills:	+%/lvl	%
Language: Native _____		98%
Language & Literacy (50/30+15%) _____	+5%	
Language & Literacy (50/30+15%) _____	+5%	
Language & Literacy (50/30+15%) _____	+5%	
Language & Literacy (50/30+15%) _____	+5%	
Computer Operation (40%+15%) _____	+5%	
Advanced Math (45%+20%) _____	+5%	
Radio: Basic (45%+10%) _____	+5%	
Basic Electronics (30%+10%) _____	+5%	
Science: _____ (+25%) _____		
First Aid (45%+10%) _____	+5%	
W.P. Energy Pistol _____		
Hand to Hand: _____		

I.Q.: _____ Skill Bonus: + _____ %
 M.E.: _____ Save vs Psionics/Insanity: + _____
 M.A.: _____ Trust/Intimidate: _____ %
 P.S.: _____ Damage Bonus: + _____
 P.P.: _____ Strike/Parry/Dodge Bonus: + _____
 P.E.: _____ Coma/Death: + _____ % Poison/Magic: + _____
 P.B.: _____ Charm/Impress: _____ %
 Spd (mph/kmph): _____ (/) Flying: _____ (/)
 P.P.E.: _____ I.S.P.: _____
 Armor M.D.C./S.D.C.: _____

Race: _____
 Sex: _____ Height: _____ Weight: _____ Age: _____
 Physical Description: _____

Place of Origin: _____

Disposition: _____

Allies: _____

Enemies: _____

O.C.C. Related Skills:	+%/lvl	%

Natural/Special Abilities, Powers & Vulnerabilities:

Secondary Skills:	+%/lvl	%

Bonuses:

RIFTS[®] Phase World: Draconid R.C.C.[™]



Name: _____
 Alignment: _____
 M.D.C.: _____ Horror Factor: _____
 S.D.C./Hit Points: _____
 Level: _____ Experience: _____
 O.C.C.: _____
 Savings: _____

I.Q.: _____ Skill Bonus: + _____ %
 M.E.: _____ Save vs Psionics/Insanity: + _____
 M.A.: _____ Trust/Intimidate: _____ %
 P.S.: _____ Damage Bonus: + _____
 P.P.: _____ Strike/Parry/Dodge Bonus: + _____
 P.E.: _____ Coma/Death: + _____ % Poison/Magic: + _____
 P.B.: _____ Charm/Impress: _____ %
 Spd (mph/kmph): _____ (/) Flying: _____ (/)
 P.P.E.: _____ I.S.P.: _____
 Armor M.D.C./S.D.C.: _____

Race: Draconid
 Sex: _____ Height: _____ Weight: _____ Age: _____
 Physical Description: _____

Place of Origin: _____
 Disposition: _____
 Allies: _____

Enemies: _____

O.C.C. Skills:		+%/lvl	%
Language: Dragonese/Elven			98%
Language: Trade Five			98%
Language _____	(50%+20%)	+5%	_____
Language _____	(50%+20%)	+5%	_____
Basic Math	(45%+15%)	+5%	_____
Basic Radio	(45%+10%)	+5%	_____
Basic Electronics	(30%+10%)	+5%	_____
Demon and Monster Lore	(25%+15%)	+5%	_____
Pilot _____	(____+10%)	_____	_____
Wilderness Survival	(30%+10%)	+5%	_____
W.P. _____			_____
W.P. _____			_____
Hand to Hand: _____			_____

O.C.C. Related Skills:		+%/lvl	%
_____			_____
_____			_____
_____			_____
_____			_____
_____			_____
_____			_____
_____			_____
_____			_____
_____			_____
_____			_____

Secondary Skills:		+%/lvl	%
_____			_____
_____			_____
_____			_____
_____			_____
_____			_____
_____			_____
_____			_____
_____			_____
_____			_____
_____			_____

Natural/Special Abilities, Powers & Vulnerabilities:
 Nightvision 90 ft (27.4 m). See the invisible. Bio-regenerate 3D6 M.D.C. every five minutes. Supernatural strength. Bite inflicts 2D4 M.D. Impervious to normal weapons, fire & cold. Magic, psionics and M.D. weapons have full effect. _____

Bonuses:
 +1 vs magic. +3 vs horror factor. _____

RIFTS[®] Phase World: Naruni Repo-Bot O.C.C.[™]

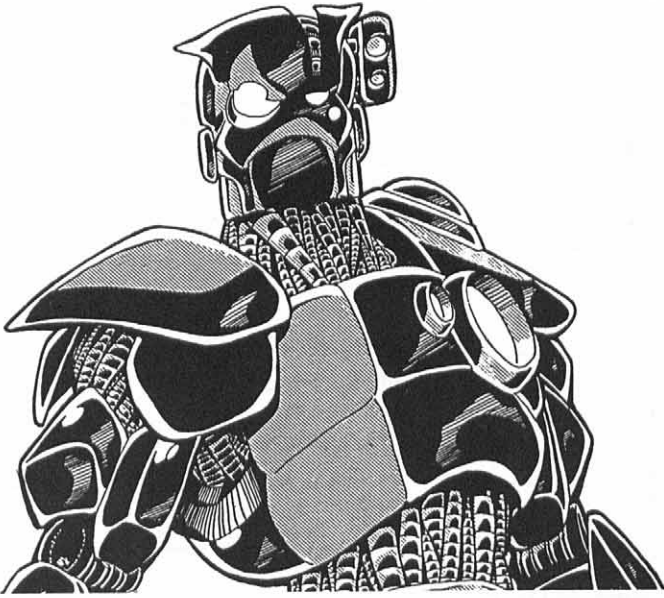

Name: _____
 Alignment: _____
 Horror Factor: _____
 Level: _____ Experience: _____
 O.C.C.: _____
 Savings: _____

I.Q.: _____ Skill Bonus: + _____ %
 M.E.: _____ Save vs Psionics/Insanity: + _____
 M.A.: _____ Trust/Intimidate: _____ %
 P.S.: 50 Damage Bonus: + _____
 P.P.: 26 Strike/Parry/Dodge Bonus: + _____
 P.E.: _____ Coma/Death: + _____ % Poison/Magic: + _____
 P.B.: _____ Charm/Impress: _____ %
 Spd (mph/kmph): _____ (/) Flying: _____ (/)
 P.P.E.: _____ I.S.P.: _____

M.D.C. by location: Head 200 (-2 to hit). Main Body 600. Arms 200 each. Legs 240 each. Force Field 300.

O.C.C. Skills:	+%/lvl	%
Language: Native		98%
Basic Radio	(45%+10%)	+5%
Language	(50%+15%)	+5%
Language	(50%+15%)	+5%
Computer Operations	(40%+10%)	+5%
Pilot	(_____ +10%)	
Pilot	(_____ +10%)	
Weapon Systems	(40%+15%)	+5%
Tracking	(25%+5%)	+5%
W.P.		
W.P.		
Hand to Hand:		

Race: _____
 Sex: _____ Height: _____ Weight: _____ Age: _____
 Physical Description: _____

 Place of Origin: _____
 Disposition: _____
 Allies: _____

 Enemies: _____

O.C.C. Related Skills:	+%/lvl	%

Built-in Weapon Systems: Particle beam weapon (1D4 x 10 per shot, 2000 feet/610 m range, unlimited payload). Plasma flamethrower (5D6 M.D. to a 20 feet/6.1 m area, 200 feet/61 m range, unlimited payload). Finger-laser (4D6 M.D., 2000 feet/610 m range, unlimited payload). Any heavy energy weapon can be plugged to the repo-bot's power supply for an unlimited payload.

Cybernetic Systems: Multi-optic eye, infra/ultra eye ultra-ear, amplified hearing, polarized filters, and sensor hand. Internal oxygen supply will keep the Repo-Bot alive for 96 hours.

Natural/Special Abilities, Powers & Vulnerabilities:
 Run up to 100 mph/160 km without tiring. _____

Secondary Skills:	+%/lvl	%

Bonuses:
 +2 to initiative. +8 to strike, parry and dodge. 1 extra attack per melee. Includes P.P. bonuses. _____

RIFTS® Phase World:™ Noro Mystic Warrior O.C.C.



Name: _____
 Alignment: _____
 M.D.C.: _____ Horror Factor: _____
 S.D.C./Hit Points: _____
 Level: _____ Experience: _____
 O.C.C.: _____
 Savings: _____

I.Q.: _____ Skill Bonus: + _____ %
 M.E.: _____ Save vs Psionics/Insanity: + _____
 M.A.: _____ Trust/Intimidate: _____ %
 P.S.: _____ Damage Bonus: + _____
 P.P.: _____ Strike/Parry/Dodge Bonus: + _____
 P.E.: _____ Coma/Death: + _____ % Poison/Magic: + _____
 P.B.: _____ Charm/Impress: _____ %
 Spd (mph/kmph): _____ (/) Flying: _____ (/)
 P.P.E.: _____ I.S.P.: _____
 Armor M.D.C./S.D.C.: _____

Race: Noro
 Sex: _____ Height: _____ Weight: _____ Age: _____
 Physical Description: _____

Place of Origin: _____
 Disposition: _____
 Allies: _____
 Enemies: _____

Natural/Special Abilities, Powers & Vulnerabilities:
 Bio-feedback (+3D6x10 S.D.C. +20% vs coma/death for 1 I.S.P.).
 Mind Blast (1D6 M.D. for every 5 I.S.P. max 2D6 M.D.+1D6 M.D. per level Range 300 feet/90 m).

Bonuses:
 +3 vs horror factor. _____

O.C.C. Skills:	+%/lvl	%
Language: Native _____		98%
Language _____ (50%+15%)	+5%	_____
Language _____ (50%+15%)	+5%	_____
Language _____ (50%+15%)	+5%	_____
Monster and Demon Lore (25%+10%)	+5%	_____
Pilot _____ (+10%)		_____

Power Armor Combat: Basic
 W.P. Energy Pistol
 W.P. Energy Rifle
 Hand to Hand: _____

O.C.C. Related Skills:	+%/lvl	%

Secondary Skills:	+%/lvl	%

RIFTS[®] Phase World: Noro Psychic O.C.C.[™]

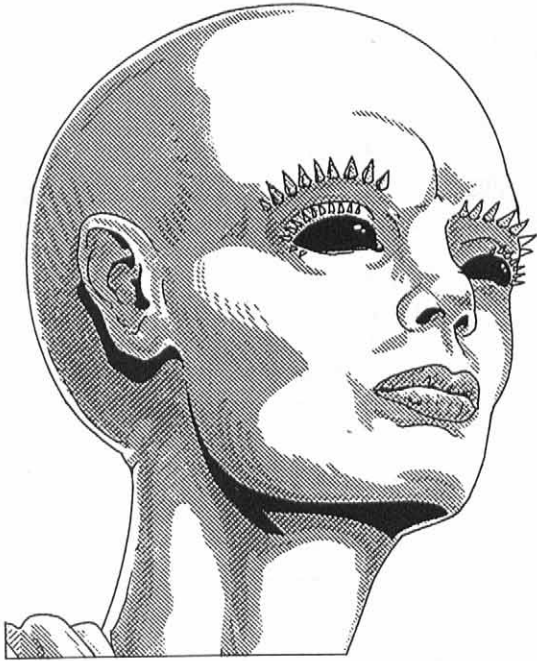

Name: _____
 Alignment: _____
 M.D.C.: _____ Horror Factor: _____
 S.D.C./Hit Points: _____
 Level: _____ Experience: _____
 O.C.C.: Noro Psychic
 Savings: _____

I.Q.: _____ Skill Bonus: +_____%
 M.E.: _____ Save vs Psionics/Insanity: +_____
 M.A.: _____ Trust/Intimidate: _____%
 P.S.: _____ Damage Bonus: +_____
 P.P.: _____ Strike/Parry/Dodge Bonus: +_____
 P.E.: _____ Coma/Death: +_____% Poison/Magic: +_____
 P.B.: _____ Charm/Impress: _____%
 Spd (mph/kmph): ____ (/) Flying: ____ (/)
 P.P.E.: _____ I.S.P.: _____
 Armor M.D.C./S.D.C.: _____

Race: Noro
 Sex: _____ Height: _____ Weight: _____ Age: _____
 Physical Description: _____

Place of Origin: _____
 Disposition: _____
 Allies: _____
 Enemies: _____

Natural/Special Abilities, Powers & Vulnerabilities:
 Summon Entities (10 I.S.P. haunting, 20 I.S.P. syphon, 30 I.S.P. tectonic, 40 I.S.P. possessing). _____

Bonuses:
 +2 to save vs. psionics. _____

O.C.C. Skills:	+%/lvl	%
Language: Native		98%
Basic Math	(45%+20%) +5%	
Advanced Math	(45%+20%) +5%	
Basic Radio	(45%+15%) +5%	
Computer Operation	(40%+15%) +5%	
Biology	(30%+10%) +5%	
Pathology	(40%+10%) +5%	
Medical Doctor	(60/50+15%) +5%	
Criminal Sciences and Forensics	(35%+15%) +5%	

O.C.C. Related Skills:	+%/lvl	%

Secondary Skills:	+%/lvl	%

RIFTS[®] Phase World: Phase Mystic O.C.C.[™]



Name: _____
Alignment: _____
M.D.C.: None _____ Horror Factor: 10
S.D.C./Hit Points: _____
Level: _____ Experience: _____
O.C.C.: Phase Mystic
Savings: _____

I.Q.: _____ Skill Bonus: + _____ %
M.E.: _____ Save vs Psionics/Insanity: + _____
M.A.: _____ Trust/Intimidate: _____ %
P.S.: _____ Damage Bonus: + _____
P.P.: _____ Strike/Parry/Dodge Bonus: + _____
P.E.: _____ Coma/Death: + _____ % Poison/Magic: + _____
P.B.: _____ Charm/Impress: _____ %
Spd (mph/kmph): _____ (/) Flying: _____ (/)
P.P.E.: _____ I.S.P.: _____
Armor M.D.C./S.D.C.: _____

Race: _____
Sex: _____ Height: _____ Weight: _____ Age: _____
Physical Description: _____

Place of Origin: _____
Disposition: _____
Allies: _____

Enemies: _____

Natural/Special Abilities, Powers & Vulnerabilities:
Magical Resistance (negates spells that target the mystic). _____

Bonuses:
+2 on initiative. _____

O.C.C. Skills:	+%/lvl	%
Language: Native _____		98%
Language & Literacy: Promethean _____		98%
Language & Literacy: Trade Two _____		98%
Language _____ (50%+25%)	+5%	
Language _____ (50%+25%)	+5%	
Basic Math _____ (45%+20%)	+5%	
Advanced Math _____ (45%+10%)	+5%	
Galactic Lore _____ (25%+10%)	+5%	
Pilot Small Spacecraft _____ (60%+15%)	+3%	
Pilot _____ (_____+10%)		
Pilot _____ (_____+10%)		
Prowl _____ (25%+10%)	+5%	
Detect Ambush _____ (30%+20%)	+5%	
W.P. Sword _____		
W.P. Energy Pistol _____		
W.P. Energy Rifle _____		
Hand to Hand: _____		

O.C.C. Related Skills:	+%/lvl	%

Secondary Skills:	+%/lvl	%

RIFTS[®] Phase World: Promethean R.C.C.[™]



Name: _____
Alignment: _____
M.D.C.: None Horror Factor: 10
S.D.C./Hit Points: _____
Level: _____ Experience: _____
O.C.C.: _____
Savings: _____

I.Q.: _____ Skill Bonus: + _____ %
M.E.: _____ Save vs Psionics/Insanity: + _____
M.A.: _____ Trust/Intimidate: _____ %
P.S.: _____ Damage Bonus: + _____
P.P.: _____ Strike/Parry/Dodge Bonus: + _____
P.E.: _____ Coma/Death: + _____ % Poison/Magic: + _____
P.B.: _____ Charm/Impress: _____ %
Spd (mph/kmph): _____ (/) Flying: _____ (/)
P.P.E.: _____ I.S.P.: _____
Armor M.D.C./S.D.C.: _____

O.C.C. Skills:		+%/lvl	%
Language & Literacy: Promethean			<u>98%</u>
Language & Literacy: Trade Two			<u>98%</u>
Language _____	(50%+25%)	<u>+5%</u>	_____
Language _____	(50%+25%)	<u>+5%</u>	_____
Basic Math _____	(45%+20%)	<u>+5%</u>	_____
Advanced Math _____	(45%+20%)	<u>+5%</u>	_____
Hand to Hand: _____			_____

Race: Promethian
Sex: _____ Height: _____ Weight: _____ Age: _____
Physical Description: _____

Place of Origin: _____
Disposition: _____
Allies: _____

O.C.C. Related Skills:		+%/lvl	%

Enemies: _____

Natural/Special Abilities, Powers & Vulnerabilities:
Doesn't breathe air. Impervious to radiation and normal heat and cold. Can see in total darkness. Has eagle-like normal vision. Phased bodies (M.D. is S.D.C. damage & S.D.C. half damage). Phase teleportation (1 mile/1.6 km per level, 50% +4% per level). Automatically Sense Dimensional Anomalies (1 mile/1.6 km). Ley Line Phasing. Supernatural strength. Phase-tech weapons inflict double damage. _____

Secondary Skills:		+%/lvl	%

Other Bonuses
+1 on initiative. +6 vs magic. +3 vs psionics. +6 vs horror factor.

RIFTS[®] Phase World: Promethean Phase Adept O.C.C.[™]



Name: _____
Alignment: _____
M.D.C.: None **Horror Factor:** 10
S.D.C./Hit Points: _____
Level: _____ **Experience:** _____
O.C.C.: Phase Adept
Savings: _____

I.Q.: _____ **Skill Bonus:** + _____ %
M.E.: _____ **Save vs Psionics/Insanity:** + _____
M.A.: _____ **Trust/Intimidate:** _____ %
P.S.: _____ **Damage Bonus:** + _____
P.P.: _____ **Strike/Parry/Dodge Bonus:** + _____
P.E.: _____ **Coma/Death:** + _____ % **Poison/Magic:** + _____
P.B.: _____ **Charm/Impress:** _____ %
Spd (mph/kmph): _____ (/) **Flying:** _____ (/)
P.P.E.: _____ **I.S.P.:** _____
Armor M.D.C./S.D.C.: _____

Race: Promethian
Sex: _____ **Height:** _____ **Weight:** _____ **Age:** _____
Physical Description: _____

Place of Origin: _____
Disposition: _____
Allies: _____

Enemies: _____

Natural/Special Abilities, Powers & Vulnerabilities:
 Doesn't breathe air. Impervious to radiation and normal heat and cold. Can see in total darkness. Has eagle-like normal vision. Phased bodies (M.D. is S.D.C. damage & S.D.C. half damage). Phase teleportation (1 mile/1.6 km per level, 50% +4% per level). Automatically Sense Dimensional Anomalies (1 mile/1.6 km). Ley Line Phasing. Supernatural strength. Phase-tech weapons inflict double damage. Magical Resistance (negates spells that target adept).

Other Bonuses
 1 additional attack per melee. +3 on initiative. +6 vs magic. +3 vs psionics. +6 vs horror factor. _____

O.C.C. Skills:	+%/lvl	%
Language & Literacy: Promethean		98%
Language & Literacy: Trade Two		98%
Language _____ (50%+25%)	+5%	
Language _____ (50%+25%)	+5%	
Basic Math _____ (45%+20%)	+5%	
Advanced Math _____ (45%+20%)	+5%	
Galactic Lore _____ (25%+15%)	+5%	
Pilot Small Spacecraft _____ (60%+20%)	+3%	
Pilot _____ (_____+15%)		
Pilot _____ (_____+15%)		
Prowl _____ (25%+15%)	+5%	
Detect Ambush _____ (30%+20%)	+5%	
W.P. Sword		
W.P. Energy Pistol		
W.P. Energy Rifle		
Hand to Hand: Martial Arts		

O.C.C. Related Skills:	+%/lvl	%

Secondary Skills:	+%/lvl	%

RITFS[®] Phase World: Promethean Time Master O.C.C.[™]



Name: _____
 Alignment: _____
 M.D.C.: None Horror Factor: 10
 S.D.C./Hit Points: _____
 Level: _____ Experience: _____
 O.C.C.: _____
 Savings: _____

I.Q.: _____ Skill Bonus: + _____ %
 M.E.: _____ Save vs Psionics/Insanity: + _____
 M.A.: _____ Trust/Intimidate: _____ %
 P.S.: _____ Damage Bonus: + _____
 P.P.: _____ Strike/Parry/Dodge Bonus: + _____
 P.E.: _____ Coma/Death: + _____ % Poison/Magic: + _____
 P.B.: _____ Charm/Impress: _____ %
 Spd (mph/kmph): _____ (/) Flying: _____ (/)
 P.P.E.: _____ I.S.P.: _____
 Armor M.D.C./S.D.C.: _____

Race: Promethian
 Sex: _____ Height: _____ Weight: _____ Age: _____
 Physical Description: _____

Place of Origin: _____
 Disposition: _____
 Allies: _____

Enemies: _____

Insanities: _____

Natural/Special Abilities, Powers & Vulnerabilities:
 Doesn't breathe air. Impervious to radiation and normal heat and cold. Can see in total darkness. Has eagle-like normal vision. Phased bodies (M.D. is S.D.C. damage & S.D.C. half damage). Phase teleportation (1 mile/1.6 km per level, 50% +4% per level). Automatically Sense Dimensional Anomalies (1 mile/1.6 km). Ley Line Phasing. Supernatural strength. Phase-tech weapons inflict double damage. _____

Other Bonuses
 +1 on initiative. +6 vs magic. +3 vs psionics. +6 vs horror factor. _____

O.C.C. Skills:	+%/lvl	%
Language & Literacy: Promethean		98%
Language & Literacy: Trade Two		98%
Language _____ (50%+25%)	+5%	_____
Language _____ (50%+25%)	+5%	_____
Basic Math (45%+20%)	+5%	_____
Advanced Math (45%+20%)	+5%	_____
Demon & Monster Lore (25%+15%)	+5%	_____
Pilot _____ (+10%)		_____
W.P. Energy Pistol		_____
Hand to Hand: _____		_____

O.C.C. Related Skills:	+%/lvl	%
_____	_____	_____
_____	_____	_____
_____	_____	_____
_____	_____	_____
_____	_____	_____
_____	_____	_____
_____	_____	_____
_____	_____	_____
_____	_____	_____
_____	_____	_____
_____	_____	_____

Secondary Skills:	+%/lvl	%
_____	_____	_____
_____	_____	_____
_____	_____	_____
_____	_____	_____
_____	_____	_____
_____	_____	_____
_____	_____	_____
_____	_____	_____
_____	_____	_____
_____	_____	_____
_____	_____	_____

TM
RIFTS® Phase World: Runner O.C.C.

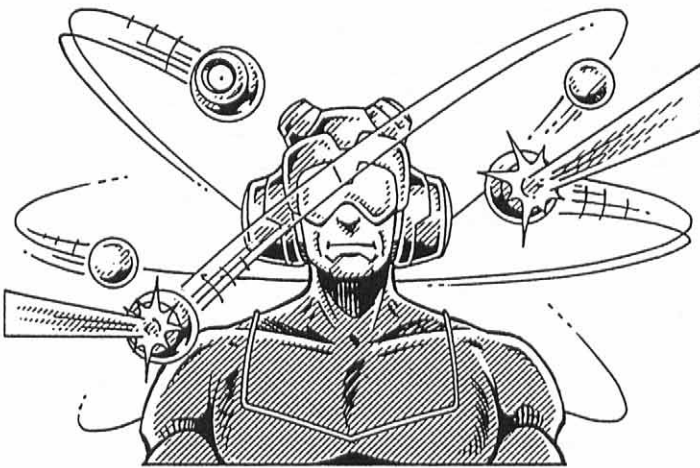

Name: _____
 Alignment: _____
 M.D.C.: _____ Horror Factor: _____
 S.D.C./Hit Points: _____
 Level: _____ Experience: _____
 O.C.C.: _____
 Savings: _____

I.Q.: _____ Skill Bonus: + _____ %
 M.E.: _____ Save vs Psionics/Insanity: + _____
 M.A.: _____ Trust/Intimidate: _____ %
 P.S.: _____ Damage Bonus: + _____
 P.P.: _____ Strike/Parry/Dodge Bonus: + _____
 P.E.: _____ Coma/Death: + _____ % Poison/Magic: + _____
 P.B.: _____ Charm/Impress: _____ %
 Spd (mph/kmph): _____ (/) Flying: _____ (/)
 P.P.E.: _____ I.S.P.: _____
 Armor M.D.C./S.D.C.: _____

Race: _____
 Sex: _____ Height: _____ Weight: _____ Age: _____

Physical Description: _____

Place of Origin: _____

Disposition: _____

Allies: _____

Enemies: _____

Natural/Special Abilities, Powers & Vulnerabilities:

Bonuses:

O.C.C. Skills:		+%/lvl	%
Language: Native _____			98%
Language _____	(50%+20%)	+5%	_____
Language _____	(50%+20%)	+5%	_____
Basic Math _____	(45%+10%)	+5%	_____
Basic Radio _____	(45%+15%)	+5%	_____
Radio: Scramblers _____	(35%+10%)	+5%	_____
Cryptography _____	(25%+10%)	+5%	_____
Movement: Zero Gravity _____	(P.P.x5+5%)	+4%	_____
EVA _____	(40%+5%)	+5%	_____
Pilot _____	(____+15%)	_____	_____
Pilot _____	(____+15%)	_____	_____
Weapon Systems _____	(40%+5%)	+5%	_____
Read Sensory Equipment _____	(30%+15%)	+5%	_____
Streetwise _____	(20%+10%)	+4%	_____
W.P. _____			_____
W.P. _____			_____
Hand to Hand: _____			_____

O.C.C. Related Skills:		+%/lvl	%
_____			_____
_____			_____
_____			_____
_____			_____
_____			_____
_____			_____
_____			_____
_____			_____
_____			_____
_____			_____

Secondary Skills:		+%/lvl	%
_____			_____
_____			_____
_____			_____
_____			_____
_____			_____
_____			_____
_____			_____
_____			_____
_____			_____
_____			_____

TM
RIFTS® Phase World: Space Pirate O.C.C.

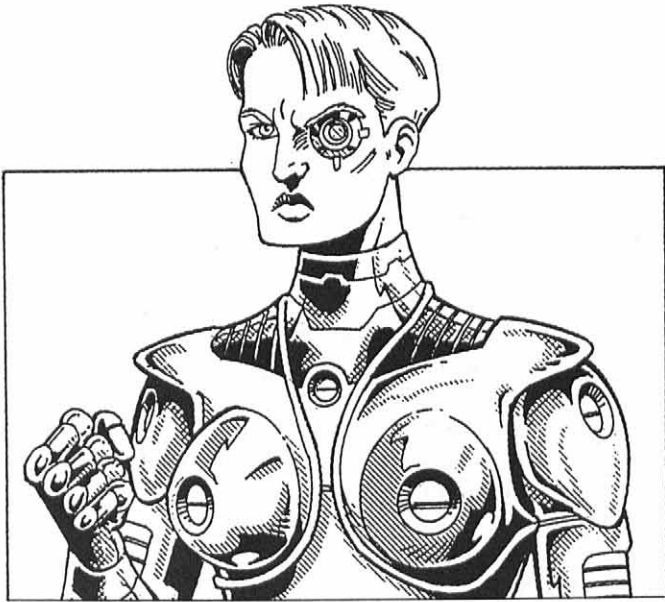

Name: _____
Alignment: _____
M.D.C.: _____ Horror Factor: _____
S.D.C./Hit Points: _____
Level: _____ Experience: _____
O.C.C.: _____
Savings: _____

I.Q.: _____ Skill Bonus: + _____ %
M.E.: _____ Save vs Psionics/Insanity: + _____
M.A.: _____ Trust/Intimidate: _____ %
P.S.: _____ Damage Bonus: + _____
P.P.: _____ Strike/Parry/Dodge Bonus: + _____
P.E.: _____ Coma/Death: + _____ % Poison/Magic: + _____
P.B.: _____ Charm/Impress: _____ %
Spd (mph/kmph): _____ (/) Flying: _____ (/)
P.P.E.: _____ I.S.P.: _____
Armor M.D.C./S.D.C.: _____

O.C.C. Skills:	+%/lvl	%
Language: Native _____		98%
Basic Math (45%+10%)	+5%	
Basic Radio (45%+10%)	+5%	
Movement: Zero Gravity (P.P.x5+5%)	+4%	
EVA (40%+10%)	+5%	
Pilot _____ (____+10%)		
Pilot _____ (____+10%)		
Weapon Systems (40%+10%)	+5%	
Read Sensory Equipment (30%+10%)	+5%	
Streetwise (20%+10%)	+4%	
W.P. Energy Pistol		
W.P. Energy Rifle		
W.P. _____		
Hand to Hand: _____		

Race: _____
Sex: _____ Height: _____ Weight: _____ Age: _____
Physical Description: _____
Place of Origin: _____
Disposition: _____
Allies: _____
Enemies: _____

Natural/Special Abilities, Powers & Vulnerabilities:

O.C.C. Related Skills:	+%/lvl	%

Secondary Skills:	+%/lvl	%

Bonuses:

+1 to parry and dodge. _____

RIFTS[®] Phase World: Spacer O.C.C.[™]

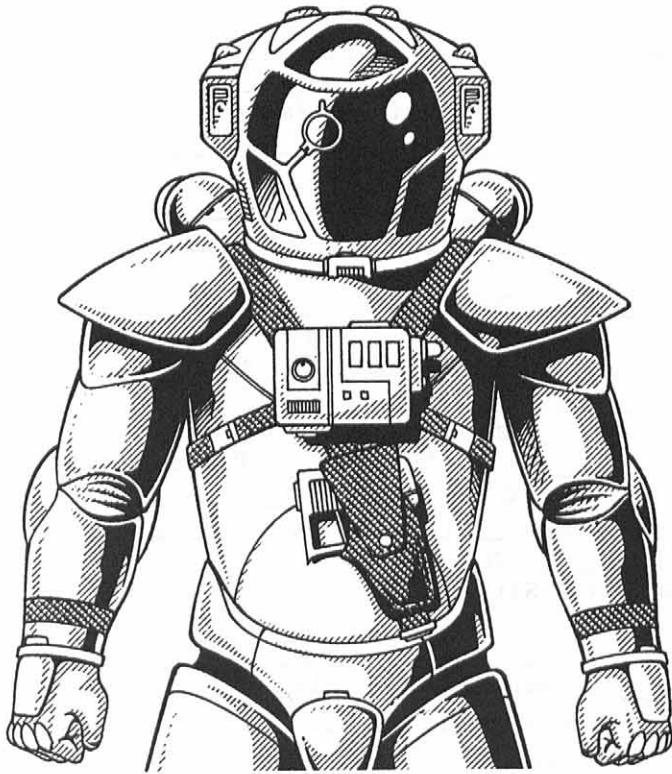

Name: _____
 Alignment: _____
 M.D.C.: _____ Horror Factor: _____
 S.D.C./Hit Points: _____
 Level: _____ Experience: _____
 O.C.C.: _____
 Savings: _____

I.Q.: _____ Skill Bonus: + _____%
 M.E.: _____ Save vs Psionics/Insanity: + _____
 M.A.: _____ Trust/Intimidate: _____%
 P.S.: _____ Damage Bonus: + _____
 P.P.: _____ Strike/Parry/Dodge Bonus: + _____
 P.E.: _____ Coma/Death: + _____% Poison/Magic: + _____
 P.B.: _____ Charm/Impress: _____%
 Spd (mph/kmph): _____ (/) Flying: _____ (/)
 P.P.E.: _____ I.S.P.: _____
 Armor M.D.C./S.D.C.: _____

Race: _____
 Sex: _____ Height: _____ Weight: _____ Age: _____
 Physical Description: _____

O.C.C. Skills:		+%/lvl	%
Language: Native	_____		98%
Basic Math	(45%+10%)	+5%	_____
Basic Radio	(45%+15%)	+5%	_____
Spaceship Mechanics	(22%+10%)	+5%	_____
First Aid	(45%+10%)	+5%	_____
Movement: Zero Gravity	(P.P.x5+15%)	+4%	_____
EVA	(40%+10%)	+5%	_____
Pilot	(____+15%)		_____
Pilot	(____+15%)		_____
Read Sensory Equipment	(30%+10%)	+5%	_____
Computer Operation	(40%+10%)	+5%	_____
W.P.	_____		_____
W.P.	_____		_____
Hand to Hand:	_____		_____

Place of Origin: _____
 Disposition: _____
 Allies: _____
 Enemies: _____

Natural/Special Abilities, Powers & Vulnerabilities:

O.C.C. Related Skills:		+%/lvl	%

Secondary Skills:		+%/lvl	%

Bonuses:
 +2 to save against space dangers. _____

RIFTS® Phase World:™ TVIA Inspector O.C.C.



Name: _____
 Alignment: _____
 M.D.C.: _____ Horror Factor: _____
 S.D.C./Hit Points: _____
 Level: _____ Experience: _____
 O.C.C.: _____
 Savings: _____

I.Q.: _____ Skill Bonus: +_____%
 M.E.: _____ Save vs Psionics/Insanity: +_____
 M.A.: _____ Trust/Intimidate: _____%
 P.S.: _____ Damage Bonus: +_____
 P.P.: _____ Strike/Parry/Dodge Bonus: +_____
 P.E.: _____ Coma/Death: +_____% Poison/Magic: +_____
 P.B.: _____ Charm/Impress: _____%
 Spd (mph/kmph): _____ (/) Flying: _____ (/)
 P.P.E.: _____ I.S.P.: _____
 Armor M.D.C./S.D.C.: _____

Race: _____
 Sex: _____ Height: _____ Weight: _____ Age: _____
 Physical Description: _____

O.C.C. Skills:	+%/lvl	%
Language: Native _____		98%
Language: Trade _____ (50%+20%)	+5%	
Language: Trade _____ (50%+20%)	+5%	
Language: Trade _____ (50%+20%)	+5%	
Law: Consortium _____ (30%+15%)	+5%	
Intelligence _____ (32%+10%)	+4%	
Computer Operation _____ (40%+10%)	+5%	
Computer Programming _____ (30%+10%)	+5%	
Computer Hacking _____ (15%+10%)	+5%	
Basic Radio _____ (45%+5%)	+5%	
Surveillance Systems _____ (30%+10%)	+5%	
Criminal Sciences and Forensics _____ (35%+10%)	+5%	

W.P. _____
 W.P. _____
 Hand to Hand: _____

O.C.C. Related Skills:	+%/lvl	%

Secondary Skills:	+%/lvl	%

Place of Origin: _____
 Disposition: _____
 Allies: _____
 Enemies: _____

Natural/Special Abilities, Powers & Vulnerabilities:

Bonuses:

RIFTS[®] Phase World: Wolfen Quatoria O.C.C.[™]



Name: _____
 Alignment: _____
 Horror Factor: 12, but 14 when internal body revealed.
 Level: _____ Experience: _____
 O.C.C.: _____
 Savings: _____

I.Q.: _____ Skill Bonus: + _____ %
 M.E.: _____ Save vs Psionics/Insanity: + _____
 M.A.: _____ Trust/Intimidate: _____ %
 P.S.: 40 Damage Bonus: + _____
 P.P.: 22 Strike/Parry/Dodge Bonus: + _____
 P.E.: _____ Coma/Death: + _____ % Poison/Magic: + _____
 P.B.: _____ Charm/Impress: _____ %
 Spd (mph/kmph): _____ (/) Flying: _____ (/)
 P.P.E.: _____ I.S.P.: _____
M.D.C. by location: Body 350. Hands 25 each. Arms 75 each.
 Legs 120 each. Head 90.

Race: Wolfen
 Sex: _____ Height: _____ Weight: _____ Age: _____
 Physical Description: _____

Place of Origin: _____
 Disposition: _____
 Allies: _____

Enemies: _____

Hand to Hand Combat: Restrained Punch 1D6+25 S.D.C. Full Strength Punch 1D6 M.D. Power Punch 2D6 M.D. Head Butt 1D4 M.D. Kick 1D8 M.D. Jump Kick/Leap Attack 3D4 M.D. Judo Style Throw/Flip 1D4 M.D. Full Speed Ram/Body Block 1D4 M.D.

Natural/Special Abilities, Powers & Vulnerabilities:
 Living Shell: (More than 100 S.D.C./1 M.D.C. damage will reveal the cyborg body: Horror Factor 14). Nano-Machine Regeneration (2D6 M.D.C. or 3D6 S.D.C. per hour). Sensory Suite (includes heat, motion, radiation and radar detection, 500 feet/152 m range and radar 5 mile/8 km range, 75% chance of identify targets, location and speed/direction of travel). Bionic lung with gas filter and oxygen storage cell. Language translator. Built-in loudspeaker. Radio receiver and transmitter. _____

Bonuses:
 +5 strike and parry. +4 dodge. +1 to initiative. +2 to pull punch/roll with impact. (includes the P.P. 22 bonus and optic/sensor considerations). +6 vs psionics. +2 vs horror factor. 1 extra attack per melee. _____

O.C.C. Skills:	+%/lvl	%
Language: Native _____		<u>98%</u>
Radio: Basic (45%+10%)	<u>+5%</u>	_____
Surveillance Systems (30%+10%)	<u>+5%</u>	_____
Basic Electronics (30%+10%)	<u>+5%</u>	_____
Detect Ambush (30%+15%)	<u>+5%</u>	_____
Detect Concealment (25%+15%)	<u>+5%</u>	_____
Intelligence (32%+5%)	<u>+4%</u>	_____
Pilot: Small Starship (36%+10%)	<u>+4%</u>	_____
W.P. Energy Pistol	_____	_____
W.P. Energy Rifle	_____	_____
Hand to Hand: _____	_____	_____

O.C.C. Related Skills:	+%/lvl	%
_____	_____	_____
_____	_____	_____
_____	_____	_____
_____	_____	_____
_____	_____	_____
_____	_____	_____
_____	_____	_____
_____	_____	_____
_____	_____	_____
_____	_____	_____
_____	_____	_____

Secondary Skills:	+%/lvl	%
_____	_____	_____
_____	_____	_____
_____	_____	_____
_____	_____	_____
_____	_____	_____
_____	_____	_____
_____	_____	_____
_____	_____	_____
_____	_____	_____
_____	_____	_____
_____	_____	_____

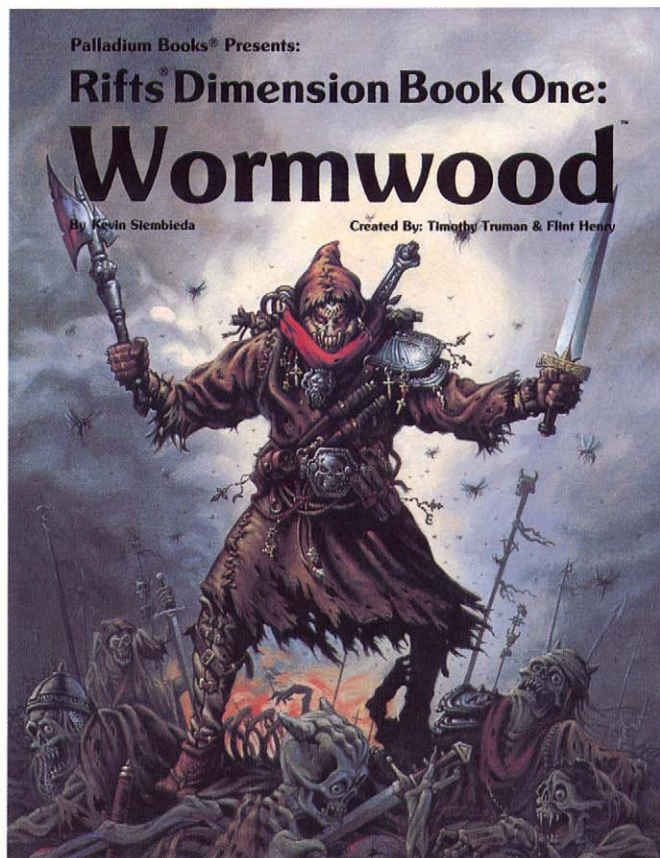

Also from Palladium Books®

Rifts® Dimension Book One: Wormwood

A world torn apart by ravaging monsters and dark magic. Champions like the apok, wormspeakers, knights, holy terrors, and all who crave freedom and life fight against seemingly impossible odds. They fight against demonic armies, crawling towers, monstrous parasites and sometimes themselves. Discover the strange new world of Wormwood, the Living Planet. Art by Tim Truman, Flint Henry, Roger Petersen, and Kevin Siembieda. Discover what happens when evil and magic conquers a planet.

- 17 new Occupational Character Classes.
- Crystal magic and mystic weapons.
- Symbiotic magic, slime and augmentation.
- Over 30 horrific monsters and villains.
- The Unholy and his demonic legion.
- Explore the mysteries of Wormwood, the Living Planet.
- Written by Kevin Siembieda, based on concepts by Tim Truman and Flint Henry.
- 17 page comic strip by Truman and Henry.
- A new world of adventure.
- 160 pages — \$15.95

**Available at hobby shops, book,
and comic stores everywhere!**

Palladium Books® Presents:

Rifts® Dimension Book Two: Phase World™

- Over 30 new Occupational Characters Classes and R.C.C.s, including the phase mystic, noro psychic, cosmo-knight, imperial legionnaire, draconid, silhouette and more.
- Phase magic, spells, weapons and powers.
- Three Galaxies described. Each with its own unique history, technology, and O.C.C.s.
- Phase World, a dimensional nexus to a thousand worlds.
- More on Naruni Enterprises and the Splugorth.
- More weapons, armor, spaceships and equipment.
- Adventure suggestions, ideas and NPCs.
- Over 200 pages.

A supplement for the Rifts® RPG.

Compatible with the entire Palladium Books® Megaverse®!

\$20.95

Cat. No. 816

I.S.B.N. 0916211-73-8

ISBN 0-916211-73-8

